

# INDEX BY PRODUCTS

**SMAW [Stick Electrodes]** 15

**SMAW**

**SAW [Wire/Flux Combination]** 123

**SAW**

**GMAW [Solid Wire & Stainless MIG Wire]** 193

**GMAW**

**GTAW [TIG Rod]** 251

**GTAW**

**FCAW [Flux Cored Wire]** 279

**FCAW**

**Non-ferrous metal Welding Consumables** 465

**Non-FERROUS**

**APPENDIX** 491

**APPENDIX**

# Index by Products

## SMAW [Stick Electrodes]

Mild steels				
Product	AWS	JIS	EN	Page
S-4301.I	A5.1/ ASME SFA5.1 E6019	Z3211 E4319	ISO 2560-A E35 2 RA 1 2	16
S-4303.V	-	Z3211 E4303	ISO 2560-A E38 2 RA 1 2	18
S-4303.T	-	Z3211 E4303	ISO 2560-A E38 0 RA 1 2	19
S-6010.D	A5.1/ ASME SFA5.1 E6010	Z3211 E4310	ISO 2560-A E38 0 C 2 1	20
S-6011.D	A5.1/ ASME SFA5.1 E6011	Z3211 E4311	ISO 2560-A E38 0 C 1 1	21
S-6013.LF	A5.1/ ASME SFA5.1 E6013	Z3211 E4313	ISO 2560-A E38 0 R 1 2	22
S-6013.V	A5.1/ ASME SFA5.1 E6013	Z3211 E4313	ISO 2560-A E38 0 RC 1 1	24
S-6027.LF	A5.1/ ASME SFA5.1 E6027	Z3211 E4327	ISO 2560-A E38 0 R 1 4	25
S-7014.F	A5.1/ ASME SFA5.1 E7014	-	ISO 2560-A E42 0 R 1 2	27
S-7024.F	A5.1/ ASME SFA5.1 E7024	Z3211 E4924	ISO 2560-A E42 0 RR 7 4	28
S-7016.O	A5.1/ ASME SFA5.1 E7016	Z3211 E4316	ISO 2560-A E42 2 B 1 2	30
S-7016.M	A5.1/ ASME SFA5.1 E7016	Z3211 E4316	ISO 2560-A E42 2 B 1 2	31

High tensile steels				
Product	AWS	JIS	EN	Page
S-7016.H	A5.1/ ASME SFA5.1 E7016	Z3211 E4916	ISO 2560-A E42 2 B 1 2	32
S-7016.HR	A5.1/ ASME SFA5.1 E7016 H4R	Z3211 E4916 H5	ISO 2560-A E42 3 B 1 2 H5	33
S-7016.LF	A5.1/ ASME SFA5.1 E7016	Z3211 E4916	ISO 2560-A E42 3 B 1 2	35
S-7016.G	A5.1/ ASME SFA5.1 E7016	Z3211 E4916	ISO 2560-A E42 3 B 1 2	36
S-7018.G	A5.1/ ASME SFA5.1 E7018	Z3211 E4918	ISO 2560-A E42 3 B 1 2	37
S-7018.GH	A5.1/ ASME SFA5.1 E7018	Z3211 E4918 H5	ISO 2560-A E42 3 B 3 2 H5	38
S-7028.F	A5.1/ ASME SFA5.1 E7028	Z3211 E4928	ISO 2560-A E42 2 B 7 4	40
S-7048.V	A5.1/ ASME SFA5.1 E7048	Z3211 E4948	ISO 2560-A E42 3 B 3 5	42
S-8016.G	A5.5/ ASME SFA5.5 E8016-G	Z3211 E5516	ISO 2560-A E46 3 1Ni B 1 2	43
S-8018.G	A5.5/ ASME SFA5.5 E8018-G	Z3211 E5518	ISO 2560-A E46 2 1Ni B 3 2	44
S-9016.G	A5.5/ ASME SFA5.5 E9016-G	Z3211 E5716	ISO 2560-A E50 2 B 1 2	45
S-10016.G	A5.5/ ASME SFA5.5 E10016-G	Z3211 E6916-N4CM1 U	757 E55 0 B 1 2	46
S-11016.G	A5.5/ ASME SFA5.5 E11016-G	-	757 E62 2 Mn2NiMo B 1 2	47
S-9018.M	A5.5/ ASME SFA5.5 E9018-M	-	757 E50 4 B 4 2	48
S-11018.M	A5.5/ ASME SFA5.5 E11018-M	-	757 E62 4 B 4 2	49

## Weather proof steels

Product	AWS	JIS	EN	Page
S-7018.W	A5.5/ ASME SFA5.5 E7018-W1	Z3214 DA5026G	ISO 2560-A E42 2 B 3 2	50
S-8018.W	A5.5/ ASME SFA5.5 E8018-W2	Z3214 DA5826W	ISO 2560-A E50 2 B 3 2	51

## Low-temperature service steels

Product	AWS	JIS	EN	Page
S-7018.1	A5.1/ ASME SFA5.1 E7018-1	Z3211 E4918	ISO 2560-A E42 4 B 3 2	52
S-7018.1H	A5.1/ ASME SFA5.1 E7018-1 H4R	Z3211 E4918 H5	ISO 2560-A E42 4 B 3 2 H5	53
S-76LTH	A5.5/ ASME SFA5.5 E7016-G	Z3211 E4916-N1 AP L	ISO 2560-A E42 6 Z B H5	55
S-78LTH	A5.5/ ASME SFA5.5 E7018-G	-	ISO 2560-A E46 5 1Ni B 3 2 H5	57
S-7016.LS	A5.5/ ASME SFA5.5 E7016-G H4R	Z3211 E4916-N1 AP L	ISO 2560-A E46 6 1Ni B 1 2	59
S-8016.C1	A5.5/ ASME SFA5.5 E8016-C1	Z3211 E5516-N5 AP L	ISO 2560-A E46 5 2Ni B 1 2	61
S-8016.C2	A5.5/ ASME SFA5.5 E8016-C2	Z3211 E5516-N7 AP L	ISO 2560-A E46 6 3Ni B 1 2	62
S-8016.C3	A5.5/ ASME SFA5.5 E8016-C3	Z3211 E5516-N2	ISO 2560-A E46 4 1Ni B 1 2	63
S-8018.C1	A5.5/ ASME SFA5.5 E8018-C1	Z3211 E5518-N5 AP L	ISO 2560-A E46 5 1Ni B 3 2	64
S-8018.C3	A5.5/ ASME SFA5.5 E8018-C3	Z3211 E5518-N2	ISO 2560-A E46 4 1Ni B 3 2	65

## Heat-resistant, Low alloy steels

Product	AWS	JIS	EN	Page
S-7010.A1	A5.5/ ASME SFA5.5 E7010-A1	-	ISO 2560-A - E42 0 Mo C 1 5	66
S-7016.A1	A5.5/ ASME SFA5.5 E7016-A1	Z3223 E4916-1M3	1599 - E Mo B 1 2	67
S-7018.A1	A5.5/ ASME SFA5.5 E7018-A1	Z3223 E4918-1M3	1599 - E Mo B 3 2	68
S-8016.B1	A5.5/ ASME SFA5.5 E8016-B1	-	1599 - E CrMo0.5 B 1 2	69
S-8016.B2	A5.5/ ASME SFA5.5 E8016-B2	Z3223 E5516-1CM	1599 - E CrMo1 B 1 2	70
S-8018.B2	A5.5/ ASME SFA5.5 E8018-B2	Z3223 E5518-1CM	1599 - E CrMo1 B 3 2	71
S-8018.B2R	A5.5/ ASME SFA5.5 E8018-B2	Z3223 E5518-1CM	1599 - ECrMo1 B 3 2 H5	72
S-9016.B3	A5.5/ ASME SFA5.5 E9016-B3	Z3223 E6216-2C1M	1599 - ECrMo2 B 1 2	74
S-9018.B3	A5.5/ ASME SFA5.5 E9018-B3	Z3223 E6218-2C1M	1599 - ECrMo2 B 3 2	75
S-9018.B3R	A5.5/ ASME SFA5.5 E9018-B3	Z3223 E6218-2C1M	1599 - ECrMo2 B 3 2 H5	76
S-8016.B5	A5.5/ ASME SFA5.5 E8016-B5	-	1599 - ECrMo5 B 1 2	78
S-8016.B6	A5.5/ ASME SFA5.5 E8016-B6	Z3223 DT2516	1599 - ECrMo5 B 1 2	79
S-9015.B9	A5.5/ ASME SFA5.5 E9015-B9	Z3223 E6215-9C1MV	1599 - ECrMo91 B 4 2 H5	81
S-9016.B9	A5.5/ ASME SFA5.5 E9016-B9 H4	Z3223 E6216-9C1MV	1599 - ECrMo91 B 3 2 H5	83
S-9015(6).B92	A5.5/ ASME SFA5.5 E9015(6)-G (E9015(6)-B9 mod.)	-	-	85

# Index by Products

## Hardfacing applications

Product	AWS	JIS	EN	Page
S-240A.R	-	Z3251 DF2A-250-R	-	87
S-350A.R	-	Z3251 DF2A-350-R	-	88
S-260A.B	-	Z3251 DF2A-300-B	-	89
S-350B.B	-	Z3251 DF2A-400-B	-	90
S-450B.B	-	Z3251 DF2A-450-B	-	91
S-500B.B	-	Z3251 DF2B-500-B	-	92
S-600B.B	-	Z3251 DF2B-600-B	-	93
S-700B.B	-	Z3251 DF3C-600-B	-	94
S-711	-	Z3251 DFCrA-600-BR	-	95
S-13MN.B	-	Z3251 DFMA-250-B	-	96

## Stainless steels

Product	AWS	JIS	EN	Page
S-308.16N	A5.4/ ASME SFA5.4 E308-16	Z3221 ES308-16	ISO 3581-A-E 19 9 R	97
S-308H.16	A5.4/ ASME SFA5.4 E308H-16	-	-	98
S-308L.16N[17]	A5.4/ ASME SFA5.4 E308L-16	Z3221 ES308L-16	ISO 3581-A-E 19 9 L R	99
	A5.4/ ASME SFA5.4 E308L-17	Z3221 ES308L-17	ISO 3581 E 19 9 L R	
S-308Mo.16	A5.4/ ASME SFA5.4 E308Mo-16	Z3221 ES308Mo-16	ISO 3581-A-E 20 10 3	101
S-308LT.16	A5.4/ ASME SFA5.4 E308L-16	Z3221 ES308L-16	ISO 3581-A-E 19 9 L R	102
S-309.16N	A5.4/ ASME SFA5.4 E309-16	Z3221 ES309-16	ISO 3581-A-E 23 12 R	103
S-309L.16[17]	AWS A5.4/ ASME SFA5.4 E309L-16	Z3221 ES309L-16	ISO 3581-A-E 23 12 L R	104
	AWS A5.4/ ASME SFA5.4 E309L-17	Z3221 ES309L-17	ISO 3581-A-E 23 12 L R	
S-309Mo.16	A5.4/ ASME SFA5.4 E309Mo-16	Z3221 ES309Mo-16	ISO 3581-A-E 23 12 2 R	106
S-309MoL.16	A5.4/ ASME SFA5.4 E309LMo-16	Z3221 ES309LMo-16	ISO 3581-A-E 23 12 2 L R	107
S-310.15	A5.4/ ASME SFA5.4 E310-15	Z3221 ES310-15	ISO 3581-A-E 25 20 B	108
S-310.16	A5.4/ ASME SFA5.4 E310-16	Z3221 ES310-16	ISO 3581-A-E 25 20 R	109
S-312.16	A5.4/ ASME SFA5.4 E312-16	Z3221 ES312-16	ISO 3581-A-E 29 9 R	110
S-316.16N	A5.4/ ASME SFA5.4 E316-16	Z3221 ES316-16	ISO 3581-A-E 19 12 3 R	111
S-316L.16N[17]	A5.4/ ASME SFA5.4 E316L-16	Z3221 ES316L-16	ISO 3581-A-E 19 12 3 L R	112
	A5.4/ ASME SFA5.4 E316L-17	Z3221 ES316L-17	ISO 3581-A-E 19 12 3 L R	
S-316LT.16	A5.4/ ASME SFA5.4 E316L-16	Z3221 ES316L-16	ISO 3581-A-E 19 12 3 L R	114



S-317.16	A5.4/ ASME SFA5.4 E317-16	Z3221 ES317-16	-	115
S-347.16	A5.4/ ASME SFA5.4 E347-16	Z3221 ES347-16	ISO 3581-A-E 19 9 Nb R	116
S-2209.16	A5.4/ ASME SFA5.4 E2209-16	Z3221 ES2209-16	ISO 3581-A-E 22 9 3 N L	117
S-2594.16	A5.4/ ASME SFA5.4 E2594-16	-	ISO 3581-A-E 25 9 4 N L	118

## Cast iron

Product	AWS	JIS	EN	Page
S-NCl	A5.15/ ASME SFA5.15 ENi-Cl	Z3252 DFCNi	ISO 1071 - E C Ni-Cl 1	119
S-NFC	A5.15/ ASME SFA5.15 ENiFe-Cl	Z3252 DFCNiFe	ISO 1071 - E C NiFe-Cl 1	120
S-FCF	A5.15/ ASME SFA5.15 ES <sub>t</sub>	Z3252 DFCFe	ISO 1071 - E Z 1	121

## SAW [Wire/Flux Combination]

Product	AWS	JIS	EN	Page
S-777MX × H-14	A5.17/ ASME SFA5.17 F7A0-EH14	Z3183 S502-H	ISO 14174 S A AR 1 / 14171 S4	124
S-777MXT × H-14	A5.17/ ASME SFA5.17 F7A0-EH14	-	ISO 14174 S A AR 1 / 14171 S4	126
(M-12K)	A5.17/ ASME SFA5.17 F7A(P)Z-EM12K	-	ISO 14174 S A AR 1 / 14171 S2Si	
S-777MXT × A-2	A5.23/ ASME SFA5.23 F8PZ-EA2-A2	-	ISO 14174 S A AR 1 / 14171 S2Mo	128
(B-2)	A5.23/ ASME SFA5.23 F8PZ-EB2-B2	-	ISO 14174 S A AR 1 / 14171 S2CrMo1	
S-777MXH × H-14	A5.17/ ASME SFA5.17 F7A(P)Z-EH14	Z3183 S502-H	ISO 14174 S A AB 1 / 14171 S4	130
S-777MXH × A-3	A5.23/ ASME SFA5.23 F8A4-EA3-A3	Z3183 S584-H	ISO 14174 S A AB 1 / 14171 S4Mo	132
S-727 × L-8(L-12)	A5.17/ ASME SFA5.17 F7A2-EL8(EL12)	Z3183 S502-H	ISO 14174 S A AB 1 / 14171 S1	134
S-707 × L-8	A5.17/ ASME SFA5.17 F7A4-EL8	Z3183 S502-H	ISO 14174 S A AB 1 / 14171 S1	136
S-737 × H-14	A5.17/ ASME SFA5.17 F7A(P)4-EH14	Z3183 S502-H	ISO 14174 S A AB 1 / 14171 S4	138
S-717 × M-12K	A5.17/ ASME SFA5.17 F7A(P)6-EM12K	Z3183 S502-H	ISO 14174 S A AB 1 / 14171 S2Si	140
S-707T × H-14	A5.17/ ASME SFA5.17 F7A(P)6-EH14	Z3183 S502-H	ISO 14174 S A AB 1 / 14171 S4	142
S-707TP × H-14	A5.17/ ASME SFA5.17 F7A(P)6-EH14	Z3183 S502-H	ISO 14174 S A AB 1 / 14171 S4	144
S-787TB × H-14	A5.17/ ASME SFA5.17 F7A(P)8-EH14	Z3352 S A FB 1	ISO 14174 S A FB 1 / 14171 S4	146
Superflux55ULT × H-14	A5.17/ ASME SFA5.17 F7A(P)8-EH14	Z3183 S502-H	ISO 14174 S A FB 1 / 14171 S4	148
Superflux787 × H-12K	A5.17/ ASME SFA5.17 F7A(P)8-EH12K	Z3183 S502-H	ISO 14174 S A FB 1 / 14171 S3Si	150
Superflux787 × H-14	A5.17/ ASME SFA5.17 F7A(P)8-EH14	Z3183 S502-H	ISO 14174 S A FB 1 / 14171 S4	152
S-787TT × H-12K	A5.17/ ASME SFA5.17 F7A(P)8-EH12K	-	ISO 14174 S A AB 1 / 14171 S3Si	154
(H-14)	A5.17/ ASME SFA5.17 F7A(P)8-EH14	Z3183 S502-H	ISO 14174 S A AB 1 / 14171 S4	

# Index by Products

Superflux55LP × H-14	A5.17/ ASME SFA5.17 F7A(P)β-EH14	Z3183 S502-H	ISO 14174 S A AB 1 / 14171 S4	156
Superflux800T × M-12K	A5.17/ ASME SFA5.17 F7Aβ-EM12K	-	ISO 14174 S A AB 1 / 14171 S2Si	158
(A-2)	A5.23/ ASME SFA5.23 F8A4-EA2-A3	-	ISO 14174 S A AB 1 / 14171 S2Mo	
S-800WT × M-12K	A5.17/ ASME SFA5.17 F7Aβ-EM12K	-	ISO 14174 S A FB 1 / 14171 S2Si	160
Superflux600 × H-14	A5.17/ ASME SFA5.17 F7A(P)β-EH14	Z3183 S502-H	ISO 14174 S A AB 1 / 14171 S4	162
(A-3)	A5.23/ ASME SFA5.23 F8A(P)β-EA3-G	Z3183 S584-H	ISO 14174 S A AB 1 / 14171 S4Mo	
S-800MX × A-G	A5.23/ ASME SFA5.23 F8Aβ-EG-G	Z3183 S502-H	ISO 14174 S A AR 1 / 14171 S4	164
(A-3)	A5.23/ ASME SFA5.23 F8AZ-EA3-G	Z3183 S582-H	ISO 14174 S A AR 1 / 14171 S4Mo	
S-800P × M-12K	A5.17/ ASME SFA 5.17 F7A2-EM12K	Z3183 S502-H	ISO 14174 S A AB 1 / 14171 S2Si	166
(H-14)	A5.17/ ASME SFA 5.17 F7A(P)β-EH14	Z3183 S502-H	ISO 14174 S A AB 1 / 14171 S4	
S-800P × A-G	A5.23/ ASME SFA5.23 F8A4-EG-G	Z3183 S582-H	ISO 14174 S A AB 1 / 14171 S4	168
(A-3)	A5.23/ ASME SFA5.23 F8A4(P2)-EA3-G	Z3183 S584-H	ISO 14174 S A AB 1 / 14171 S4Mo	
S-800CM × B-2	A5.23/ ASME SFA5.23 F8P2-EB2-B2	-	ISO 14174 S A FB 1 / 14171 S2CrMo1	170
S-800SP × M-12K	A5.17/ ASME SFA5.17 F7A4-EM12K	Z3183 S502-H	ISO 14174 S A AB 1 / 14171 S2Si	172
(A-2)	A5.23/ ASME SFA5.23 F9TA4G-A2/F8A2-EA2-G	Z3183 S582-H	ISO 14174 S A AB 1 / 14171 S2Mo	
S-900SP × M-12K	A5.17/ ASME SFA5.17 F7A4(P2)-EM12K	Z3183 S502-H	ISO 14174 S A CS 1 / 14171 S2Si	174
(A-2)	A5.23/ ASME SFA5.23 F9A2-EA2-G	Z3183 S582-H	ISO 14174 S A CS 1 / 14171 S2Mo	
S-460Y × H-14	A5.23/ ASME SFA5.23 F8Aβ-EH14-G	Z3183 S584-H	ISO 14174 S A FB 1 / 14171 S4	176
S-100 × F-3	A5.23/ ASME SFA5.23 F9A(P)β-EF3-F3	-	ISO 14174 S A FB 1 / 14171 S3Ni1Mo	178
(M-4)	A5.23/ ASME SFA5.23 F11A(P)β-EG-M4	-	ISO 14174 S A FB 1 / 14171	
S-705EF × H-14	-	-	ISO 14174 S A CG-11 / 14171 S4	180
S-705HF × H-14	-	-	ISO 14174 S A CG-11 / 14171 S4	182
S-400HF × SC-414S,	-	-	ISO 14174 S A AB 3	184
SC-423S, SC-420S, SC-420SG				

## Stainless steel

Product	AWS	JIS	EN	Page
Superflux300S × YS-308(L)	-	Z3324 FSS-B1/YS308(L)	ISO 14174 S A AB 2	185
Superflux300S × YS-309(L)	-	Z3324 FSS-B1/YS309(L)	ISO 14174 S A AB 2	187
Superflux300S × YS-316(L)	-	Z3324 FSS-B1/YS316(L)	ISO 14174 S A AB 2	189
Superflux209 × YS-2209	-	-	ISO 14174 S A AF 2	191
S-300EM × Flux for ESW	-	-	ISO 14174 SA AF2	192

## GMAW [Solid Wire & Stainless MIG Wire]

Mild steel & 490MPa high tensile steels				
Product	AWS	JIS	EN	Page
SM-70	A5.18/ ASME SFA5.18 ER70S-6	Z3312 YGW12	ISO 14341-A G 42 2 C 3Si1 ISO 14341-A G 42 4 M 3Si1	194
SM-70EN	A5.18/ ASME SFA5.18 ER70S-6	Z3312 YGW12	ISO 14341-A G 42 2 C 4Si1 ISO 14341-A G 46 4 M 4Si1	196
SM-70G	A5.18/ ASME SFA5.18 ER70S-G	Z3312 YGW11	ISO 14341-A G3Si1	198
SM-70S	A5.18/ ASME SFA5.18 ER70S-3	Z3312 YGW16	ISO 14341-A G2Si	200
SM-70GS	A5.18/ ASME SFA5.18 ER70S-G	Z3312 YGW15	ISO 14341-A G2Si	202

High tensile steels				
Product	AWS	JIS	EN	Page
SM-1N	A5.28/ ASME SFA5.28 ER80S-Ni1	-	-	204
SM-55H	-	Z3312 YGW18	ISO 14341-B S18	206
SM-80G	A5.28/ ASME SFA5.28 ER80S-G	Z3312 G 59J A 1 U C 3M1T	ISO 14341-B S3M1T	208
SM-100	A5.28/ ASME SFA5.28 ER100S-G	-	-	210
SM-110	A5.28/ ASME SFA5.28 ER110S-G	-	-	212
SM-80CM	A5.28/ ASME SFA5.28 ER80S-G	Z3317 YG1CM-A	ISO 14341-B S2M3	214

MIG Wire for Stainless steels				
Product	AWS	JIS	EN	Page
SM-307Si	-	-	ISO 14343-A G 18 8 Mn	216
SM-308	A5.9/ ASME SFA5.9 ER308	Z3321 YS308	ISO 14343-A G 19 9	218
SM-308L	A5.9/ ASME SFA5.9 ER308L	Z3321 YS308L	ISO 14343-A G 19 9L	220
SM-308LSi	A5.9/ ASME SFA5.9 ER308LSi	Z3321 YS308LSi	ISO 14343-A G 19 9L Si	222
SM-309	A5.9/ ASME SFA5.9 ER309	Z3321 YS309	ISO 14343-A G 23 12	224
SM-309L	A5.9/ ASME SFA5.9 ER309L	Z3321 YS309L	ISO 14343-A G 23 12L	226
SM-309LSi	A5.9/ ASME SFA5.9 ER309LSi	Z3321 YS309LSi	ISO 14343-A G 23 12L Si	228
SM-309MoL	A5.9/ ASME SFA5.9 ER309LMo	Z3321 YS309LMo	ISO 14343-A G 23 12 2L	230
SM-310	A5.9/ ASME SFA5.9 ER310	Z3321 YS310	ISO 14343-A G 25 20	232
SM-312	A5.9/ ASME SFA5.9 ER312	Z3321 YS312	ISO 14343-A G 25 20	234
SM-316	A5.9/ ASME SFA5.9 ER316	Z3321 YS316	ISO 14343-A G 19 12 3	236

# Index by Products

SM-316L	A5.9/ ASME SFA5.9 ER316L	Z3321 YS316L	ISO 14343-A G 19 12 3L	238
SM-316LSi	A5.9/ ASME SFA5.9 ER316LSi	Z3321 YS316LSi	ISO 14343-A G 19 12 3L Si	240
SM-347	A5.9/ ASME SFA5.9 ER347	Z3321 YS347	ISO 14343-A G 19 9 Nb	242
SM-2209	A5.9/ ASME SFA5.9 ER2209	Z3321 YS2209	ISO 14343-A G 22 9 3N L	244
SM-410	A5.9/ ASME SFA5.9 ER410	Z3321 YS410	ISO 14343-A G 13	246
SM-430LNb	-	Z3321 YS430LNb	ISO 14343-A G 18LNb	248

## GTAW [TIG Rod]

Mild steel & 490MPa high tensile steels				
Product	AWS	JIS	EN	Page
ST-50G	A5.18/ ASME SFA5.18 ER70S-G	Z3316 YGT50	ISO 636-A-W3Si1	252
ST-50.6	A5.18/ ASME SFA5.18 ER70S-6	Z3316 YGT50	ISO 636-A-W3Si1	253
ST-50.3	A5.18/ ASME SFA5.18 ER70S-3	-	ISO 636-A-W2Si	254
ST-72	A5.18/ ASME SFA5.18 ER70S-2	Z3316 YGT50	-	255
ST-1N	A5.28/ ASME SFA5.28 ER80S-Ni1	-	-	256
ST-80CM	A5.28/ ASME SFA5.28 ER80S-G	Z3317 YG1CM-A Z3316 YGT1CM	ISO 14341-B S2M3	257

Stainless steels				
Product	AWS	JIS	EN	Page
ST-308	A5.9/ ASME SFA5.9 ER308	Z3321 YS308	ISO 14343-A W 19 9	259
ST-308L	A5.9/ ASME SFA5.9 ER308L	Z3321 YS308L	ISO 14343-A W 19 9L	260
ST-309	A5.9/ ASME SFA5.9 ER309	Z3321 YS309	ISO 14343-A W 23 12	261
ST-309L	A5.9/ ASME SFA5.9 ER309L	Z3321 YS309L	ISO 14343-A W 23 12L	262
ST-309MoL	A5.9/ ASME SFA5.9 ER309LMo	Z3321 YS309LMo	ISO 14343-A W 23 12 2L	263
ST-310	A5.9/ ASME SFA5.9 ER310	Z3321 YS310	ISO 14343-A W 25 20	264
ST-312	A5.9/ ASME SFA5.9 ER312	Z3321 YS312	ISO 14343-A W 29 9	265
ST-316	A5.9/ ASME SFA5.9 ER316	Z3321 YS316	ISO 14343-A W 19 12 3	266
ST-316L	A5.9/ ASME SFA5.9 ER316L	Z3321 YS316L	ISO 14343-A W 19 12 3L	267
ST-347	A5.9/ ASME SFA5.9 ER347	Z3321 YS347	ISO 14343-A W 19 9 Nb	268
SMT-2594	A5.9/ ASME SFA5.9 ER2594	-	ISO 14343-A G 25 9 4 NL	269
ST-2209	A5.9/ ASME SFA5.9 ER2209	Z3321 YS2209	ISO 14343-A W 22 9 3N L	271

SMT-904L	A5.9/ ASME SFA5.9 ER385	Z3321 YS385	ISO 14343-A G(W) 20 25 5 Cu L	272
ST-410	A5.9/ ASME SFA5.9 ER410	Z3321 YS410	ISO 14343-A W 13	274
SM-90B3 / ST-90B3	A5.28/ ASME SFA5.28 ER90S-B3	-	-	275
ST-91B9	A5.28/ ASME SFA5.28 ER90S-B9	-	ISO 21952-A W CrMo91	276
ST-92B9	A5.28/ ASME SFA5.28 ER90S-G	-	-	277

## FCAW [Flux Cored Wire]

### Mild steel & 490MPa high tensile steels

Product	AWS	JIS	EN	Page
SF-71	A5.36/ ASME SFA5.36 E71T1-C1A0-CS1	Z3313 T49J 0 T1-1 C A-U H10	ISO 17632-A-T 42 0 P C 1	280
SF-71LF	A5.36/ ASME SFA5.36 E71T1-C1A0-CS1	Z3313 T49J 0 T1-1 C A-U H10	-	282
Supercored 71	A5.36/ ASME SFA5.36 E71T1-C1A0-CS1	Z3313 T49 2 T1-1 C A H10	ISO 17632-A-T 42 2 P C 1	284
SC-71LH	A5.36/ ASME SFA5.36 E71T1-C1A2-CS1	Z3313 T49 3 T1-1 C A-U H5	ISO 17632-A-T 42 2 P C 1 H5	286
Supercored 71H	A5.36/ ASME SFA5.36 E71T1-C1A4-CS1	Z3313 T49 4 T1-1 C A H5	ISO 17632-A T42 4 P C 1 H5	288
SC-71HJ	A5.36/ ASME SFA5.36 E71T1-C1A4-CS1	Z3313 T49 4 T1-1 C A	ISO 17632-A T42 4 P C 1 H10	290
Supercored 71MAG	A5.36/ ASME SFA5.36 E71T1-M21A2-CS1	Z3313 T49 3 T1-1 M A-U H10	ISO 17632-A-T 42 3 P M 1	292
SC-71LHM Cored	A5.36/ ASME SFA5.36 E71T1-M21A2-CS1	Z3313 T49 3 T1-1 M A-U H5	ISO 17632-A-T 46 3 P M 1 H5	294
SF-71MC	A5.36/ ASME SFA5.36 E71T1-C1A2-CS2	-	ISO 17632-A-T 46 3 P M 1	296
	E71T1-M21A2-CS2		ISO 17632-A-T 46 2 P C 1	
SC-71MJ	A5.36/ ASME SFA5.36 E71T1-M21A4-CS1	Z3313 T49 4 T1-1 M A-U H5	ISO 17632-A T46 4 P M 1 H5	298
SF-70MX	A5.36/ ASME SFA5.36 E70T1-C1A0-CS1	Z3313 T49J 0 T15-0 C A-U H10	ISO 17632-A-T 42 0 R C 3	300
SC-70H Cored	A5.36/ ASME SFA5.36 E70T1-C1A2-CS1	Z3313 T49 3 T 15-0 C A H10	ISO 17632-A-T 42 2 R C 3	302
Supercored 70MXH	A5.36/ ASME SFA5.36 E70T1-C1A2-CS1	Z3313 T49J 2 T15-0 C A-U H5	ISO 17632-A-T 42 2 R C 3 H5	304
SC-70T Cored	A5.36/ ASME SFA5.36 E70T15-C1A0-CS1	Z3313 T49 2 T15-1 CA	ISO 17632-A-T 42 2 M C 1	306
	E70T15-M21A2-CS1	Z3313 T49 3 T15-1 MA	ISO 17632-A-T 46 2 M M 1 H5	
SC-70Z Cored	A5.36M/ ASME SFA5.36M E490T15-C1A0-G	-	ISO 17632-A-T 46 Z M M/C 3	308
	E490T15-M21A0-G			
Supercored 70NS	A5.36/ ASME SFA5.36 E70T15-M21A2-CS1	Z3313 T49 3 T15-0 M A H5	ISO 17632-A-T T 42 3 M M 3 H5	310
Supercored 70B	A5.36/ ASME SFA5.36 E71T5-M21A4-CS1 H4	Z3313 T49 4 T5-1 M A-U H5	ISO 17632-A-T42 4 B M 3 H5	312
Supercored 70SB	A5.36/ ASME SFA5.36 E71T5-C1A2-CS1 H4	Z3313 T49 4 T5-1 M A-U H5	ISO 17632-A-T 42 3 B C 2 H5	314
SC-EG2 Cored	A5.26/ASME SFA5.26 EG70T-2C	Z3319 YFEG-22C	-	316
SC-EG3	A5.26/ASME SFA5.26 EG82T-NM2	-	-	317

# Index by Products

## High tensile steels

Product	AWS	JIS	EN	Page
SC-55 Cored	A5.36/ ASME SFA5.36 E81T1-C1A0-G	Z3313 T55 2 T1-1 C A-U H10	-	318
SC-55F Cored	A5.36/ ASME SFA5.36 E80T1-C1A0-G	Z3313 T55 2 T15-0 C A-N1-U H10	-	320
Supercored 81	A5.36/ ASME SFA5.36 E81T1-C1A2-Ni1	Z3313 T55 3 T1-1 C A-N2-U H10	ISO 17632-A-T 46 2 1Ni P C 1	322
SF-80MX	A5.36/ ASME SFA5.36 E80T1-C1A2-G	Z3313 T55 2 T15-0 C A-N2 H10	ISO 17632-A-T 46 2 1Ni R C 3	324
SC-80M	A5.36/ ASME SFA5.36 E80T15-M21A4-G	-	ISO 17632-A T 46 4 M M 3 H5	326
SC-90M	A5.36/ ASME SFA5.36 E90T15-M21A6-G	-	ISO 18276-A T 55 2 Z Z M M 1 H5	328
SC-91	A5.36M/ ASME SFA5.36M E621T1-C1A0-G	Z3313 T57 2 T1-1 C A-N1 H10	ISO 17632-A T50 2 1Ni P C 1	330
SC-90	A5.36M/ ASME SFA5.36M E620T1-C1A0-G	Z3313 T62 2 T15-0 C A- H10	ISO 17632-A-T50 2 R C 3 H10	332
SC-91LP	A5.36/ ASME SFA5.36 E91T1-M21A4-G	-	ISO 17632-A-T50 4 1Ni P M 1 H5	334
SC-91P	A5.36M/ ASME SFA5.36M E621T1-M21A0-G	-	ISO 18276-A-T55 0 Z P M 1	335
SC-91K2 Cored	A5.36/ ASME SFA5.36 E81T1-C1A4-K2	Z3313 T57 4 T1-1 C A-N3 H10	ISO 17632-A T50 4 1.5Ni P C 1	336
Supercored 110	A5.36/ ASME SFA5.36 E111T1-C1A4-G H4	-	-	338
SC-110M Cored	A5.36/ ASME SFA5.36 E110T15-M21A6-G	-	ISO 18276-A-T 69 4 Mn2NiMo M M 3	340

## Weather proof steels

Product	AWS	JIS	EN	Page
SF-70W	A5.36/ ASME SFA5.36 E71T1-C1A0-G(W)	Z3320 YFA-50W	-	342
SF-80W	A5.36/ ASME SFA5.36 E81T1-C1A2-W2	Z3320 YFA-58W	-	344
SC-81WM	A5.36/ ASME SFA5.36 E81T1-M21A2-W2	-	-	346

## Low-temperature service steels

Product	AWS	JIS	EN	Page
SC-71SR	A5.36/ ASME SFA5.36 E71T1-C1A6-CS2 H4 E71T1-C1P6-CS2 H4	Z3313 T49 4 T1-1 C AP H5	ISO 17632-A T42 4 P C 1 H5	348
SC-71MSR	A5.36/ ASME SFA5.36 E71T1-M21A5-CS2 E71T1-M21P5-CS2	-	ISO 17632-A T46 4 P M 1 H5	350
SC-70ML	A5.36/ ASME SFA5.36 E70T15-M21A4-CS1	Z3313 T49 4 T15-1 M A-U H5	ISO 17632-A-T46 4 M M 2 H5	352
SC-80MR	A5.36/ ASME SFA5.36 E80T15-M21A8-G	-	ISO 17632-A T 46 6 1.5Ni M M H5	354

SC-81M	A5.36/ ASME SFA5.36 E81T1-M21A4-Ni1 H4	-	-	356
Supercored 81MAG	A5.36/ ASME SFA5.36 E81T1-M21A8-Ni1 H4 E81T1-M21P5-Ni1 H4	-	ISO 17632-A T46 6 1Ni P M 2 H5	358
Supercored 81-K2	A5.36/ ASME SFA5.36 E81T1-C1A8-K2 H4	Z3313 T55 6 T1-1 C A-N3 H5	ISO 17632-A T46 6 1.5Ni P C 1 H5	360
SC-460	A5.36/ ASME SFA5.36 E81T1-C1A6-K2	Z3313 T55 6 T1-1 C A-N3 H5	ISO 17632-A T46 6 1.5Ni P C 1 H5	362
SC-81LT	A5.36/ ASME SFA5.36 E81T1-C1A6-K2	Z3313 T55 6 T1-1 C A-N3 H5	ISO 17632-A T46 6 1.5Ni P C 1 H5	364
SC-81Ni2	A5.36/ ASME SFA5.36 E81T1-C1A8-Ni2	Z3313 T55 6 T1-1 C A-N5 H5	ISO 17632-A T46 6 2Ni P C 1 H5	366
SC-81Ni2M	A5.36/ ASME SFA5.36 E81T1-M21A8-Ni2	Z3313 T55 6 T1-1 M A-N5 H5	ISO 17632-A T46 6 2Ni P M 2 H5	368
Supercored 81-K2MAG	A5.36/ ASME SFA5.36 E81T1-M21A8-K2	Z3313 T55 6 T1-1 M A-N3 H5	ISO 17632-A T46 6 1.5Ni P M 2 H5	370
SC-80K2	A5.36/ ASME SFA5.36 E80T1-C1A8-K2 H4	Z3313 T55 6 T15-0 C A-N3 H5	ISO 17632-A-T 46 6 1.5Ni R C 3 H5	372

### Heat-resistant, Low alloy steels

Product	AWS	JIS	EN	Page
SC-81B2	A5.36/ ASME SFA5.36 E81T1-C1PZ-B2	-	ISO 17632-A-T CrMo1 P C 2	374
SC-91B3	A5.36/ ASME SFA5.36E91T1-C1PZ-B3	-	ISO 17632-A-T CrMo2 P C 2	375
SC-91B9	A5.36/ ASME SFA5.36 E91T1-C1PZ-B91 H4 E91T1-M21PZ-B91 H4	-	-	376
SC-80D2	A5.36/ ASME SFA5.36 E80T15-M21A0-G	Z3318 YFM-G	ISO 17632-A-T 46 0 MnMo M M 3	377
Supercored 1CM	A5.36/ ASME SFA5.36 E80T15-M21PZ-G(B2)	Z3318 YF1CM-G	ISO 17634-A-T CrMo1 M M 3	379

### Self-shielded

Product	AWS	JIS	EN	Page
Supershield 11	A5.36/ ASME SFA5.36 E71T11-AZ-CS3	Z3313 T49 T14-1 N A	ISO 17632-A-T 42 Z Z Z N 1	381
Supershield 71GS	A5.36/ ASME SFA5.36 E70TGS	Z3313 T49 T14-1 N S	ISO 17632-A-T 42 Z Z V N 1	382
Supershield 4	A5.36/ ASME SFA5.36 E70T4-AZ-CS3	-	ISO 17632-A-T 42 Z Z W N 3	383
Supershield EG-72T	A5.26/ ASME SFA5.26 EG72T-1	-	-	384
Supershield EG-82T	A5.26/ ASME SFA5.26 EG82T-G	-	-	385

### Stainless steels

Product	AWS	JIS	EN	Page
SW-410 Cored	A5.22/ ASME SFA5.22 E410T1-1/-4	Z3323 TS410-FB1	-	386

# Index by Products

SW-307NS Cored	-	-	ISO 17633-A-T 18 8 Mn M M	388
SW-308L Cored	A5.22/ ASME SFA5.22 E308LT1-1/-4	Z3323 TS308L-FB1	ISO 17633-A-T 19 9 L P M/C 2	389
SW-308LT	A5.22/ ASME SFA5.22 E308LT1-1/-4	Z3323 TS308L-FB1	ISO 17633-A-T 19 9 L P M/C 2	391
SW-309L Cored	A5.22/ ASME SFA5.22 E309LT1-1/-4	Z3323 TS309L-FB1	ISO 17633-A-T 23 12 L P M/C 2	393
SW-309LNS Cored	A5.9/ ASME SFA5.9 EC309L	Z3323 TS309L-MA0	ISO 17633-A-T 23 12 L M M	395
SW-309MoL Cored	A5.22/ ASME SFA5.22 E309LMoT1-1/-4	Z3323 TS309LMo-FB1	ISO 17633-A-T 23 12 2 L P M/C 2	396
SW-316L Cored	A5.22/ ASME SFA5.22 E316LT1-1/-4	Z3323 TS316L-FB1	ISO 17633-A-T 19 12 3 L P M/C 2	398
SW-316LT	A5.22/ ASME SFA5.22 E316LT1-1/-4	Z3323 TS316L-FB1	ISO 17633-A-T 19 12 3 L P M/C 2	400
SW-317L Cored	A5.22/ ASME SFA5.22 E317LT1-1/-4	Z3323 TS317L-FB1	-	402
SW-347 Cored	A5.22/ ASME SFA5.22 E347T1-1/-4	Z3323 TS347-FB1	ISO 17633-A-T 19 9 Nb P M/C 2	404
SW-308HBF	A5.22/ ASME SFA5.22 E308HT1-1/-4	-	-	406
SW-309HBF	A5.22/ ASME SFA5.22 E309HT1-1/-4	-	-	407
SW-316HBF	A5.22/ ASME SFA5.22 E316HT1-1/-4	-	-	408
SW-410NiMo Cored	A5.22/ ASME SFA5.22 E410NiMoT1-1/-4	Z3323 TS410NiMo-FB1	ISO 17633-A-T 13 4 P M/C 2	410
SW-2209 Cored	A5.22/ ASME SFA5.22 E2209T1-1/-4	Z3323 TS2209-FB1	ISO 17633-A-T 22 9 3 N L M/C 2	412
Supercored 308L	A5.22/ ASME SFA5.22 E308LT0-1/-4	Z3323 TS308L-FB0	ISO 17633-A-T 19 9 L R M/C 3	414
Supercored 309L	A5.22/ ASME SFA5.22 E309LT0-1/-4	Z3323 TS309L-FB0	ISO 17633-A-T 23 12 L R M/C 3	416
Supercored 309MoL	A5.22/ ASME SFA5.22 E309LMoT0-1/-4	Z3323 TS309LMo-FB0	ISO 17633-A-T 23 12 2 L R M/C 3	418
Supercored 316L	A5.22/ ASME SFA5.22 E316LT0-1/-4	Z3323 TS316L-FB0	ISO 17633-A-T 19 12 3 L R M/C 3	420
SF-409Ti	A5.9/ ASME SFA5.9 EC409	Z3323 TS409-MA0	-	422
SF-430	A5.9/ ASME SFA5.9 EC430	Z3323 TS430-MA0	-	423
SF-430Nb	-	Z3323 TS430Nb-MA0	12072 G Z 17 L Nb	424
SF-436	-	-	-	425
SC-439Ti Cored	-	-	-	426

## Hardfacing application

Product	AWS	JIS	EN	Page
Supershield CrC	-	-	-	427
Supershield CrCW	-	-	-	429
Supershield CrCH	-	-	-	431



Supershield CrCNb5	-	-	-	432
Supershield CrCNb	-	-	-	433
Supershield CrCMo	-	-	-	435
Supershield CrCV1	-	-	-	436
Supershield CrCB	-	-	-	437
Supershield AP-O	-	-	-	438
Supershield 16Mn-O	-	-	-	440
Supershield 309L-O	-	-	-	442
SC-BU Cored	-	-	-	443
Supershield 430-O	-	-	-	445
Supershield 410NiMo-O	-	-	-	446
SC-410NiMoS	-	-	-	447
SC-414S	-	-	-	448
SC-420S	-	-	-	449
SC-420SG	-	-	-	450
SC-423S	-	-	-	451
SC-430S	-	-	-	452
SC-30S	-	-	-	453
SC-45S	-	-	-	454
SC-55S	-	-	-	455
SC-A4S	A5.23/ ASME SFA5.23 F8P2 ECA4-A4	-	-	456
SC-42H	-	-	-	457
SC-250H	-	Z3326 YF2A-C-250	-	458
SC-350H	-	Z3326 YF2A-C-350	-	459
SC-450H	-	Z3326 YF2A-C-450	-	460
SC-600H	-	Z3326 YF3B-C-600	-	461
SC-600HM	-	-	-	462
SC-700H	-	Z3326 YF3B-C-700	-	463

# Index by Products

## Non-ferrous metal Welding Consumables

Nickel Based Alloys				
Product	AWS	JIS	EN	Page
SR-133	A5.11/ ASME SFA5.11 ENiCrFe-2	Z3224 DNiCrFe-2	ISO 14172 Ni 6092	466
SR-182	A5.11/ ASME SFA5.11 ENiCrFe-3	Z3224 DNiCrFe-	ISO 14172 Ni 6182	467
SR-134	A5.11/ ASME SFA5.11 ENiCrFe-4	Z3225 D9Ni-1	-	468
SR-08	A5.11/ ASME SFA5.11 ENiMo-8	-	-	469
SR-625	A5.11/ ASME SFA5.11 ENiCrMo-3	Z3224 DNiCrMo-3	ISO 14172 Ni 6625(NiCr22Mo9Nb)	470
Superflux300 x SA-625	-	-	-	471
SMT-625	A5.14/ ASME SFA5.14 ERNiCrMo-3	Z3334 SNI6625(NiCr22Mo9Nb)	ISO 18274 Ni 6625(NiCr22Mo9Nb)	472
SW-625	A5.34/ ASME SFA5.34 ENiCrMo3T1-4	-	ISO 12153 T Ni 6625 P M/C 2	474
SW-82 Cored	A5.34/ ASME SFA5.34 ENiCr3T1-1/-4	-	ISO 12153 T Ni 6082 P M/C 2	475
SW-182 Cored	A5.34/ ASME SFA5.34 ENiCrFe3T1-1/-4	-	ISO 12153 T Ni 6182 P M/C 2	476
SMT-08	A5.14/ ASME SFA5.14 ERNiMo-8	Z3334 SNI1008(NiMo19WCr)	-	477
SMT-825	A5.14/ ASME SFA5.14 ERNiFeCr-1	Z3334 SNI8065(NiFe30Cr21Mo3)	ISO 18274 S Ni 8065	478
SM-455 / ST-455	A5.14/ASME SFA5.14 ERNiCrMo-7	Z3334 SNI6455(NiCr16Mo16Ti)	-	479
SMT-22	A5.14/ ASME SFA5.14 ERNiCrMo-10	Z3324 S Ni6022(NiCr21Mo13Fe4W3)	ISO 18274 S Ni 6022	480
SM-82 / ST-82	A5.14/ ASME SFA5.14 ERNiCr-3	Z3334 SNI6082(NiCr20Mn3Nb)	ISO 18274 S Ni 6082	481
SM-276 / ST-276	A5.14/ ASME SFA5.14 ERNiCrMo-4	Z3334 SNI6276(NiCr15Mo16Fe6W4)	ISO 18274 S Ni 6276	482
SM-400 / ST-400	A5.14/ ASME SFA5.14 ERNiCu-7	Z3334 SNI4060(NiCu30Mn3Ti)	ISO 18274 S Ni 4060	483
SM-718 / ST-718	A5.14/ ASME SFA5.14 ERNiFeCr-2	Z3334 SNI7718(NiCr19Fe19Nb5Mo3)	ISO 18274 S Ni 7718	484
SM-60 / ST-60	A5.14/ ASME SFA5.14 ERNi-1	Z3334 SNI2061(NiTi3)	ISO 18274 S Ni 2061	485
SMT-7030	A5.7/ ASME SFA5.7 ERCuNi	Z3341 YCuNi-3	-	486
SM-9010 / ST-9010	-	Z3341 YCuNi-1	-	487
Superflux300 x SA-82	-	-	-	488
S-Ni2 x SA-08	-	-	-	489
SW-625 Cored	A5.34/ ASME SFA5.34 ENiCrMo3T1-1/-4	-	ISO 12153 T Ni 6625 P M/C 2	490

# SMAW

## Stick Electrodes



# S-4301.I

Type : Ilmenite

## Conformances

AWS A5.1/ ASME SFA5.1 E6019  
 JIS Z3211 E4319  
 EN ISO 2560-A E35 2 RA 1 2  
 KR 3  
 ABS 3

LR 3  
 BV 3  
 DNV 3  
 GL 3  
 NK KMW3

## Applications

- General fabrication
- Shipbuilding

## Features

- Suitable for butt and fillet welding of thin and medium-thick plates (up to 20mm)
- Good crack resistance, pitting resistance
- Good X-ray performance

## Welding Position



1G 2F 3G 4G  
 (PA) (PB) (PF) (PE)

## Current

AC or DC ±

## Redrying Conditions

70~100°C (158~212°F) X 0.5~1hr

## Diameter / Packaging

Diameter	Length	Standard		Vacuum				P.V.C	
		packet	carton	packet	carton	packet	carton	packet	carton
mm (in)	mm (in)	5kg(11lbs)	20kg(44lbs)	1.5kg(3.3lbs)	15kg(3.3lbs)	5kg(11lbs)	20kg(44lbs)	5kg(11lbs)	20kg(44lbs)
2.6 (3/32)	350 (14)		√						
3.2 (1/8)	350 (14)		√						
4.0 (5/32)	400 (16)		√						
	450 (18)								
4.5 (11/64)	400 (16)		√						
	450 (18)								
5.0 (3/16)	400 (16)		√						
	450 (18)								
6.0 (15/64)	450 (18)		√						

### Typical Chemical Composition of All-Weld Metal (%)

C	Si	Mn	P	S
0.05	0.10	0.37	0.021	0.014

### Typical Mechanical Properties of All-Weld Metal

Condition	YS MPa(lbs/in <sup>2</sup> )	TS MPa(lbs/in <sup>2</sup> )	EL (%)	Temp °C(°F)	CVN-Impact Value J (ft-lbs)
AW	382 (55,500)	437 (63,500)	31.2	0 (32) -20 (-4)	88 (65) 56 (42)

### Typical Operating Procedures

Diameter mm (in)	2.6 (3/32)	3.2 (1/8)	4.0 (5/32)	4.5 (11/64)	5.0 (3/16)	6.0 (15/64)
Length mm (in)	350 (14)	350 (14)	400 (16) 450 (18)	400 (16)	400 (16) 450 (18)	450 (18)
F & HF	50-85A	80-130A	120-180A	145-200A	170-250A	240-310A
V-up, OH	45-70A	60-110A	110-150A	120-180A	130-200A	-

SMAW

SAW

GMAW

GTAW

FCAW

Non-FERROUS

APPENDIX

# S-4303.V

Type : Lime-Titania

## Conformances

JIS	Z3211 E4303
EN	ISO 2560-A E38 2 RA 1 2
KR	3
ABS	3
LR	3
BV	3
DNV	3
GL	3
NK	KMW3

## Applications

- General fabrication
- Shipbuilding

## Features

- Suitable for butt and fillet welding of thin plates
- Good at vertical down
- Good mechanical properties

## Welding Position



1G 2F 3G 4G  
(PA) (PB) (PF) (PE)

## Current

AC or DC ±

## Redrying Conditions

70~100°C (158~212°F) X 0.5~1hr

## Diameter / Packaging

Diameter	Length	Standard	
		packet	carton
2.6 (3/32)	350 (14)	5kg(11lbs)	20kg(44lbs)
3.2 (1/8)	350 (14)	✓	✓
4.0 (5/32)	400 (16)	✓	✓
5.0 (3/16)	400 (16)	✓	✓
6.0 (15/64)	450 (18)	✓	✓

## Typical Chemical Composition of All-Weld Metal(%)

C	Si	Mn	P	S
0.06	0.15	0.47	0.021	0.012

## Typical Mechanical Properties of All-Weld Metal

Condition	YS MPa(lbs/in <sup>2</sup> )	TS MPa(lbs/in <sup>2</sup> )	EL (%)	Temp °C(°F)	CVN-Impact Value J (ft.lbs)
AW	433 (62,800)	470 (68,100)	33.6	0 (32) -20 (-4)	110 (81) 72 (53)

## Typical Operating Procedures

Diameter mm (in)	2.6 (3/32)	3.2 (1/8)	4.0 (5/32)	5.0 (3/16)	6.0 (15/64)
Length mm (in)	350 (14)	350 (14)	400 (16)	400 (16)	450 (18)
F & HF	65~100A	100~140A	140~190A	200~260A	250~330A
V-up, OH	50~90A	80~130A	110~170A	140~210A	-

# S-4303.T

Type : Lime-Titania

## Conformances

JIS Z3211 E4303

EN ISO 2560-A E38 0 RA 1 2

## Applications

- General fabrication
- Automotive
- Machinery

## Features

- Suitable for butt and fillet welding of thin plates
- Good striking properties and high welding efficiency
- Suitable for tack welding
- Good mechanical properties

## Welding Position



1G (PA) 2F (PB) 3G (PF) 4G (PE)

## Current

AC or DC ±

## Redrying Conditions

70~100°C (158~212°F) X 0.5~1hr

## Diameter / Packaging

Diameter mm (in)	Length mm (in)	Standard	
		packet 5kg(11lbs)	carton 20kg(44lbs)
2.6 (3/32)	350 (14)	✓	
3.2 (1/8)	350 (14)	✓	
4.0 (5/32)	400 (16)	✓	
5.0 (3/16)	400 (16)	✓	
6.0 (15/64)	450 (18)	✓	

## Typical Chemical Composition of All-Weld Metal (%)

C	Si	Mn	P	S
0.06	0.16	0.48	0.019	0.014

## Typical Mechanical Properties of All-Weld Metal

Condition	YS MPa(lbs/in <sup>2</sup> )	TS MPa(lbs/in <sup>2</sup> )	EL (%)	Temp °C(°F)	CVN-Impact Value J (ft-lbs)
AW	436 (63,300)	489 (71,000)	28.9	0 (32)	98 (73)

## Typical Operating Procedures

Diameter mm (in)	2.6 (3/32)	3.2 (1/8)	4.0 (5/32)	5.0 (3/16)	6.0 (15/64)
Length mm (in)	350 (14)	350 (14)	400 (16)	400 (16)	450 (18)
F & HF	65~100A	100~140A	140~190A	200~250A	250~330A
V-up, OH	50~90A	80~130A	110~170A	140~210A	-

SMW

SAW

GMW

GTW

FCW

Non-FERROUS

APPENDIX

# S-6010.D

Type : Cellulosic

## Conformances

AWS A5.1/ ASME SFA5.1 E6010  
 JIS Z3211 E4310  
 EN ISO 2560-A E38 0 C 2 1  
 KR 2  
 ABS 2  
 LR 2  
 BV 2  
 DNV 2  
 GL 2  
 NK KMW2  
 CWB CSA W48 E4310

## Applications

- Pipe line
- General fabrication

## Features

- Standard in the pipe welding industry
- Deep penetration
- High ductility (root pass)

## Welding Position



1G 2F 3G 4G  
 (PA) (PB) (PF-PG) (PE)

## Current

DC +

## Redrying Conditions

70~100°C (158~212°F) X 0.5~1hr

## Diameter / Packaging

Diameter mm (in)	Length mm (in)	Standard	
		packet 5kg(11lbs)	carton 20kg(44lbs)
2.6 (3/32)	350 (14)	√	
3.2 (1/8)	350 (14)	√	
4.0 (5/32)	400 (16)	√	
5.0 (3/16)	400 (16)	√	

## Typical Chemical Composition of All-Weld Metal (%)

C	Si	Mn	P	S
0.10	0.17	0.42	0.015	0.017

## Typical Mechanical Properties of All-Weld Metal

Condition	YS MPa(lbs/in <sup>2</sup> )	TS MPa(lbs/in <sup>2</sup> )	EL (%)	Temp °C(°F)	CVN-Impact Value J (ft.lbs)
AW	447 (64,900)	517 (75,000)	32.3	-30 (-22)	62 (46)

## Typical Operating Procedures

Diameter mm (in)	2.6 (3/32)	3.2 (1/8)	4.0 (5/32)	5.0 (3/16)
Length mm (in)	300 (12)	350 (14)	350 (14)	350 (14)
F & HF	50~75A	75~125A	90~165A	140~220A
V-up, OH	50~75A	75~125A	90~165A	140~220A



# S-6011.D

Type : Cellulosic

## Conformances

AWS	A5.1/ ASME SFA5.1 E6011
JIS	Z3211 E4311
EN	ISO 2560-A E38 0 C 1 1
KR	2
ABS	2
LR	2
BV	2
DNV	2
GL	2
NK	KMW2

## Applications

- Pipe line
- General fabrication
- Shipbuilding

## Features

- Standard in the pipe welding industry
- Deep penetration
- High ductility (root pass)
- AC and DC welding

## Welding Position



1G 2F 3G 4G  
(PA) (PB) (PF-PG) (PE)

## Current

AC or DC +

## Redrying Conditions

70~100°C (158~212°F) X 0.5~1hr

## Diameter / Packaging

Diameter	Length	Standard	
		packet	carton
mm (in)	mm (in)	5kg(11lbs)	20kg(44lbs)
2.6 (3/32)	350 (14)	✓	
3.2 (1/8)	350 (14)	✓	
4.0 (5/32)	400 (16)	✓	
5.0 (3/16)	400 (16)	✓	

## Typical Chemical Composition of All-Weld Metal (%)

C	Si	Mn	P	S
0.11	0.16	0.51	0.015	0.012

## Typical Mechanical Properties of All-Weld Metal

Condition	YS MPa(lbs/in <sup>2</sup> )	TS MPa(lbs/in <sup>2</sup> )	EL (%)	Temp °C(°F)	CVN-Impact Value J (ft.-lbs)
AW	468 (68,000)	558 (81,000)	29.7	-30 (-22)	51 (38)

## Typical Operating Procedures

Diameter mm (in)	2.6 (3/32)	3.2 (1/8)	4.0 (5/32)	5.0 (3/16)
Length mm (in)	300 (12)	350 (14)	350 (14)	350 (14)
F & HF	50~75A	75~125A	90~165A	140~220A
V-up, OH	50~75A	75~125A	90~165A	140~220A

SWAW

SAW

GMWAW

GTAW

FCAW

Non-FERROUS

APPENDIX

# S-6013.LF

Type : Rutile

## Conformances

AWS A5.1/ ASME SFA5.1 E6013  
 JIS Z3211 E4313  
 EN ISO 2560-A E38 0 R 1 2  
 KR 2  
 ABS 2  
 LR 2

BV 2  
 DNV 2  
 GL 2  
 NK KMW2  
 NAKS

## Applications

- General fabrication

## Features

- Suitable for butt and fillet welding of thin plates
- Good restriking
- Good bead appearance
- Easy to remove slag
- Smooth arc and low fume
- AC welding with low ocv

## Welding Position



1G 2F 3G 4G  
 (PA) (PB) (PF) (PE)

## Current

AC or DC ±

## Redrying Conditions

70~100°C (158~212°F) X 0.5~1hr

## Diameter / Packaging

Diameter	Length	Standard		Vacuum				P.V.C	
		packet	carton	packet	carton	packet	carton	packet	carton
mm (in)	mm (in)	5kg(11lbs)	20kg(44lbs)	1.5kg(3.3lbs)	15kg(3.3lbs)	5kg(11lbs)	20kg(44lbs)	5kg(11lbs)	20kg(44lbs)
2.6 (3/32)	350 (14)		✓						
3.2 (1/8)	350 (14)		✓						
4.0 (5/32)	400 (16)		✓						
	450 (18)								
5.0 (3/16)	400 (16)		✓						
	450 (18)								
6.0 (15/64)	450 (18)		✓						

### Typical Chemical Composition of All-Weld Metal (%)

C	Si	Mn	P	S
0.05	0.23	0.35	0.022	0.017

### Typical Mechanical Properties of All-Weld Metal

Condition	YS MPa(lbs/in <sup>2</sup> )	TS MPa(lbs/in <sup>2</sup> )	EL (%)	Temp °C(°F)	CVN-Impact Value J (ft-lbs)
AW	439 (63,700)	488 (70,900)	26.8	0 (32)	67 (50)

### Typical Operating Procedures

Diameter mm (in)	2.6 (3/32)	3.2 (1/8)	4.0 (5/32)	5.0 (3/16)	6.0 (15/64)
Length mm (in)	350 (14)	350 (14)	400 (16) 450 (18)	400 (16) 450 (18)	450 (18)
F & HF	50-95A	80-130A	120-180A	160-230A	220-300A
V-up, OH	45-90A	60-120A	100-160A	120-220A	-

SMAW

SAW

GMAW

GTAW

FCAW

Non-FERROUS

APPENDIX

# S-6013.V

Type : Rutile-Cellulosic

## Conformances

AWS A5.1/ ASME SFA5.1 E6013  
 JIS Z3211 E4313  
 EN ISO 2560-A E38 0 RC 1 1  
 KR 2  
 ABS 2  
 LR 2  
 NK KMW2  
 CWB CSA W48 E4313  
 TÜV EN ISO 2560-A - E38 0 RC 1 1

## Applications

- General fabrication

## Features

- Suitable for butt and fillet welding of thin plates
- Good at vertical down
- Good restriking
- Good bead appearance
- Easy to remove slag

## Welding Position

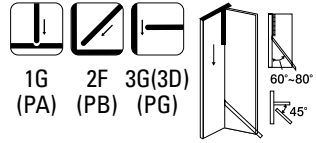

## Current

AC or DC ±

## Redrying Conditions

70~100°C (158~212°F) X 0.5~1hr

## Diameter / Packaging

Diameter mm (in)	Length mm (in)	Standard	
		packet 5kg(11lbs)	carton 20kg(44lbs)
2.6 (3/32)	350 (14)	✓	
3.2 (1/8)	350 (14)	✓	
4.0 (5/32)	400 (16)	✓	
5.0 (3/16)	400 (16)	✓	

## Typical Chemical Composition of All-Weld Metal (%)

C	Si	Mn	P	S
0.09	0.32	0.48	0.017	0.012

## Typical Mechanical Properties of All-Weld Metal

Condition	YS MPa(lbs/in <sup>2</sup> )	TS MPa(lbs/in <sup>2</sup> )	EL (%)	Temp °C(°F)	CVN-Impact Value J (ft.lbs)
AW	460 (66,700)	550 (79,800)	27.5	0 (32)	65 (48)

## Typical Operating Procedures

Diameter mm (in)	2.6 (3/32)	3.2 (1/8)	4.0 (5/32)	5.0 (3/16)
Length mm (in)	350 (14)	350 (14)	400 (16)	400 (16)
F & HF	60~100A	100~140A	140~190A	190~240A
V-up, OH	45~90A	60~120A	100~160A	120~220A

# S-6027.LF

Type : High recovery Rutile

## Conformances

AWS A5.1/ ASME SFA5.1 E6027  
 JIS Z3211 E4327  
 EN ISO 2560-A E38 0 R 1 4  
 KR 3  
 ABS 3

LR 3,3G  
 BV 3  
 DNV 3  
 GL 3  
 NK KMW3

## Applications

- General fabrication

## Features

- High efficient fillet welding
- Low fume
- Good welding performance in manual and gravity welding

## Welding Position



1G 2F  
 (PA) (PB)

## Current

AC or DC +

## Redrying Conditions

70~100°C (158~212°F) X 0.5~1hr

## Diameter / Packaging

Diameter	Length	Standard		Vacuum				P.V.C	
		packet	carton	packet	carton	packet	carton	packet	carton
		5kg(11lbs)	20kg(44lbs)	1.5kg(3.3lbs)	15kg(3.3lbs)	5kg(11lbs)	20kg(44lbs)	5kg(11lbs)	20kg(44lbs)
4.0 (5/32)	550 (22)		✓						
4.5 (11/64)	700 (28)		✓						
5.0 (3/16)	700 (28)		✓						
5.5 (7/32)	700 (28)		✓						
6.0 (15/64)	700 (28)		✓						
6.4 (1/4)	700 (28)		✓						
7.0 (9/32)	700 (28)		✓						

SMW

SAW

GMAW

GTAW

FCAW

Non-FERROUS

APPENDIX

### Typical Chemical Composition of All-Weld Metal (%)

C	Si	Mn	P	S
0.07	0.32	0.76	0.023	0.013

### Typical Mechanical Properties of All-Weld Metal

Condition	YS MPa(lbs/in <sup>2</sup> )	TS MPa(lbs/in <sup>2</sup> )	EL (%)	Temp °C(°F)	CVN-Impact Value J (ft-lbs)
AW	448 (65,100)	499 (72,500)	32.0	-30 (-22)	47 (35)

### Typical Operating Procedures

Diameter mm (in)	4.0 (5/32)	4.5 (11/64)	5.0 (3/16)	5.5 (7/32)	6.0 (15/64)	6.4 (1/4)	7.0 (9/32)
Length mm (in)	550 (22)	550 (22) 700 (28)	700 (28)	700 (28)	700 (28)	700 (28)	700 (28)
F	140~180	170~210	180~230	210~250	240~290	260~310	280~330
GW	150~180	160~200	180~240	210~260	230~290	250~310	280~330

# S-7014.F

Type : High recovery Rutile

## Conformances

AWS A5.1/ ASME SFA5.1 E7014  
 EN ISO 2560-A E42 0 R 1 2  
 KR 2, 2Y  
 ABS 2Y  
 LR 2, 2Y  
 BV 2, 2Y  
 DNV 2  
 GL 2Y  
 NK KMW52

## Applications

- General fabrication

## Features

- High welding speed
- Easy horizontal fillet and groove welding

## Welding Position



1G 2F 3G 4G  
 (PA) (PB) (PF) (PE)

## Current

AC or DC ±

## Redrying Conditions

70~100°C (158~212°F) X 0.5~1hr

## Diameter / Packaging

Diameter mm (in)	Length mm (in)	Standard	
		packet 5kg(11lbs)	carton 20kg(44lbs)
3.2 (1/8)	350 (14)	✓	
4.0 (5/32)	400 (16)	✓	
5.0 (3/16)	400 (16)	✓	
6.0 (15/64)	450 (18)	✓	

## Typical Chemical Composition of All-Weld Metal (%)

C	Si	Mn	P	S
0.07	0.30	0.66	0.022	0.015

## Typical Mechanical Properties of All-Weld Metal

Condition	YS MPa(lbs/in <sup>2</sup> )	TS MPa(lbs/in <sup>2</sup> )	EL (%)	Temp °C(°F)	CVN-Impact Value J (ft.-lbs)
AW	449 (65,200)	510 (74,100)	30.9	0 (32)	83 (61)

## Typical Operating Procedures

Diameter mm (in)	3.2 (1/8)	4.0 (5/32)	5.0 (3/16)	6.0 (15/64)
Length mm (in)	400 (16)	400 (16)	400 (16)	450 (18)
F	95~140	140~200	180~250	240~310

SMAW

SAW

GMAW

GTAW

FCAW

Non-FERROUS

APPENDIX

# S-7024.F

Type : High recovery Rutile

## Conformances

AWS A5.1/ ASME SFA5.1 E7024  
 JIS Z3211 E4924  
 EN ISO 2560-A E42 0 RR 7 4  
 ABS 2

LR 2, 2Y, 2YG  
 DNV 2 (25 t)  
 NK KMW2, KMW52  
 CWB CSA W48 E4924

## Applications

- Heavy steel fabrication
- Shipbuilding

## Features

- Highly efficient fillet welding
- High welding speed
- Good bead appearance
- Easy to remove slag

## Welding Position

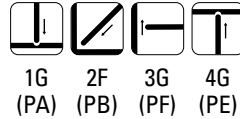

## Current

AC or DC ±

## Redrying Conditions

70~100°C (158~212°F) X 0.5~1hr

## Diameter / Packaging

Diameter	Length	Standard		Vacuum				P.V.C	
		packet	carton	packet	carton	packet	carton	packet	carton
mm (in)	mm (in)	5kg(11lbs)	20kg(44lbs)	1.5kg(3.3lbs)	15kg(3.3lbs)	5kg(11lbs)	20kg(44lbs)	5kg(11lbs)	20kg(44lbs)
3.2 (1/8)	400 (16)		✓						
4.0 (5/32)	450 (18)		✓						
4.5 (11/64)	450 (18)		✓						
	700 (28)								
5.0 (3/16)	450 (18)		✓						
	700 (28)								
6.0 (15/64)	450 (18)		✓						
	700 (28)								



### Typical Chemical Composition of All-Weld Metal (%)

C	Si	Mn	P	S
0.08	0.42	0.82	0.022	0.014

### Typical Mechanical Properties of All-Weld Metal

Condition	YS MPa(lbs/in <sup>2</sup> )	TS MPa(lbs/in <sup>2</sup> )	EL (%)	Temp °C(°F)	CVN-Impact Value J (ft-lbs)
AW	513 (74,400)	561 (81,400)	23.4	0 (32)	61 (45)

### Typical Operating Procedures

Diameter mm (in)	3.2 (1/8)	4.0 (5/32)	4.5 (11/64)	5.0 (3/16)	6.0 (15/64)
Length mm (in)	400 (16)	450 (18)	450 (18) 700 (28)	450 (18) 700 (28)	450 (18) 700 (28)
F	100~150	140~200	180~230	200~250	260~300

SMAW

SAW

GMAW

GTAW

FCAW

Non-FERROUS

APPENDIX

# S-7016.0

Type : Basic

## Conformances

AWS A5.1/ ASME SFA5.1 E7016  
 JIS Z3211 E4316  
 EN ISO 2560-A E42 2 B 1 2  
 KR 3H10, 3YH10  
 ABS 3H10, 3Y  
 LR 3, 3YH15  
 DNV 3YH10  
 NK KMW53HH  
 NAKS

## Applications

- Pipe line

## Features

- Suitable for one side welding of pipe
- Stable arc
- Relatively low current

## Welding Position



1G 2F 3G 4G  
 (PA) (PB) (PF) (PE)

## Current

AC or DC +

## Redrying Conditions

300~350°C (572~662°F) X  
 0.5~1hr

## Diameter / Packaging

Diameter mm (in)	Length mm (in)	Standard	
		packet 5kg(11lbs)	carton 20kg(44lbs)
2.6 (3/32)	350 (14)	✓	
3.2 (1/8)	350 (14)	✓	
4.0 (5/32)	400 (16)	✓	
5.0 (3/16)	400 (16)	✓	

## Typical Chemical Composition of All-Weld Metal (%)

C	Si	Mn	P	S
0.07	0.45	1.10	0.015	0.007

Condition	YS MPa(lbs/in <sup>2</sup> )	TS MPa(lbs/in <sup>2</sup> )	EL (%)	Temp °C(°F)	CVN-Impact Value J (ft.-lbs)
AW	511 (74,200)	597 (86,700)	31.2	-30 (-22)	82 (61)

## Typical Operating Procedures

Diameter mm (in)	2.6 (3/32)	3.2 (1/8)	4.0 (5/32)	5.0 (3/16)
Length mm (in)	350 (14)	400 (16)	400 (16)	400 (16)
F	60~90	90~130	130~190	180~240
FV-up, OH	50~80	80~120	110~180	150~210
Root pass	30~65	60~110	90~150	130~180

# S-7016.M

Type : Basic

## Conformances

AWS A5.1/ ASME SFA5.1 E7016  
 JIS Z3211 E4316  
 EN ISO 2560-A E42 2 B 1 2  
 KR 3H10, 3YH10  
 ABS 3H10, 3Y  
 NK KMW53HH

## Applications

- Heavy steel fabrication
- Shipbuilding
- Pressure vessels

## Features

- Suitable for butt and fillet welding of heavy structure
- Good X-ray performance
- Good mechanical properties

## Welding Position



1G 2F 3G 4G  
 (PA) (PB) (PF) (PE)

## Current

AC or DC +

## Redrying Conditions

300~350°C (572~662°F) X  
 0.5~1hr

## Diameter / Packaging

Diameter mm (in)	Length mm (in)	Standard	
		packet 5kg(11lbs)	carton 20kg(44lbs)
2.6 (3/32)	350 (14)	✓	
3.2 (1/8)	350 (14)	✓	
4.0 (5/32)	400 (16)	✓	
5.0 (3/16)	400 (16)	✓	
6.0 (15/64)	450 (18)	✓	

## Typical Chemical Composition of All-Weld Metal (%)

C	Si	Mn	P	S
0.08	0.64	1.18	0.018	0.009

## Typical Mechanical Properties of All-Weld Metal

Condition	YS MPa(lbs/in <sup>2</sup> )	TS MPa(lbs/in <sup>2</sup> )	EL (%)	Temp °C(°F)	CVN-Impact Value J (ft.-lbs)
AW	539 (78,300)	617 (89,600)	26.5	-20 (-4)	73 (54)

## Typical Operating Procedures

Diameter mm (in)	2.6 (3/32)	3.2 (1/8)	4.0 (5/32)	5.0 (3/16)	6.0 (15/64)
Length mm (in)	350 (14)	350 (14)	400 (16)	400 (16)	450 (18)
F	55~85	90~140	140~190	190~250	250~320
V-up, OH	50~80	80~130	110~170	160~210	-

SMW

SAW

GMW

GTAW

FCAW

Non-FERROUS

APPENDIX

# S-7016.H

Type : Basic

## Conformances

AWS A5.1/ ASME SFA5.1 E7016  
 JIS Z3211 E4916  
 EN ISO 2560-A E42 2 B 1 2  
 KR 3H10, 3YH10  
 ABS 3H10, 3Y  
 LR 3, 3YH15  
 BV 3YHH  
 DNV 3YH10  
 GL 3YH10  
 NK KMW53HH  
 RS 3Y H10  
 CWB CSA W48 E4916

## Applications

- Heavy steel fabrication
- Shipbuilding
- Pressure vessels

## Features

- Suitable for butt and fillet welding of heavy structure
- Good crack resistance and X-ray performance
- Good mechanical properties

## Welding Position



1G 2F 3G 4G  
 (PA) (PB) (PF) (PE)

## Current

AC or DC +

## Redrying Conditions

300~350°C (572~662°F) X  
 0.5~1hr

## Diameter / Packaging

Diameter mm (in)	Length mm (in)	Standard	
		packet 5kg(11lbs)	carton 20kg(44lbs)
2.6 (3/32)	350 (14)		✓
3.2 (1/8)	350 (14)		✓
4.0 (5/32)	400 (16)		✓
5.0 (3/16)	400 (16)		✓
6.0 (15/64)	450 (18)		✓

## Typical Chemical Composition of All-Weld Metal (%)

C	Si	Mn	P	S
0.08	0.62	1.22	0.017	0.011

## Typical Mechanical Properties of All-Weld Metal

Condition	YS MPa(lbs/in <sup>2</sup> )	TS MPa(lbs/in <sup>2</sup> )	EL (%)	Temp °C(°F)	CVN-Impact Value J (ft.lbs)
AW	560 (81,300)	620 (90,700)	28.5	-30 (-22)	80 (59)

## Typical Operating Procedures

Diameter mm (in)	2.6 (3/32)	3.2 (1/8)	4.0 (5/32)	5.0 (3/16)	6.0 (15/64)
Length mm (in)	350 (14)	350 (14)	400 (16)	400 (16)	450 (18)
F	55-85	90-130	130-180	180-240	250-310
V-up, OH	50-80	80-120	110-170	150-200	-

# S-7016.HR

Type : Basic

## Conformances

AWS A5.1/ ASME SFA5.1 E7016 H4R

JIS Z3211 E4916 H5

EN ISO 2560-A E42 3 B 1 2 H5

## Applications

- Heavy steel fabrication
- Shipbuilding
- Pressure vessels

## Features

- Extra low hydrogen electrode
- Good mechanical properties
- Vacuum sealed package available (HDM ≤ 4ml/100g)

## Welding Position



1G 2F 3G 4G  
(PA) (PB) (PF) (PE)

## Current

AC or DC +

## Redrying Conditions

300~350°C (572~662°F) X

0.5~1hr

## Diameter / Packaging

Diameter	Length	Standard		Vacuum				P.V.C	
		packet	carton	packet	carton	packet	carton	packet	carton
mm (in)	mm (in)	5kg(11lbs)	20kg(44lbs)	1.5kg(3.3lbs)	15kg(3.3lbs)	5kg(11lbs)	20kg(44lbs)	5kg(11lbs)	20kg(44lbs)
2.6 (3/32)	350 (14)	✓		✓		✓		✓	
3.2 (1/8)	350 (14)	✓		✓		✓		✓	
4.0 (5/32)	400 (16)	✓		✓		✓		✓	
5.0 (3/16)	400 (16)	✓		✓		✓		✓	

SMW

SAW

GMW

GTAW

FCW

Non-FERROUS

APPENDIX

**Typical Chemical Composition of All-Weld Metal (%)**

C	Si	Mn	P	S
0.064	0.56	1.00	0.012	0.005

**Typical Mechanical Properties of All-Weld Metal**

Condition	YS MPa(lbs/in <sup>2</sup> )	TS MPa(lbs/in <sup>2</sup> )	EL (%)	Temp °C(°F)	CVN-Impact Value J (ft-lbs)
AW	493 (71,500)	561 (81,400)	30.4	-30 (-22)	173 (128)

**Typical Operating Procedures**

Diameter mm (in)	2.6 (3/32)	3.2 (1/8)	4.0 (5/32)	5.0 (3/16)
Length mm (in)	350 (14)	350 (14)	400 (16) 450 (18)	400 (16) 450 (18)
F &HF	50-95A	90-140A	130-180A	180-240A
V-up, OH	50-95A	90-130A	120-160A	150-200A

# S-7016.LF

Type : Basic

## Conformances

AWS	A5.1/ ASME SFA5.1 E7016
JIS	Z3211 E4916
EN	ISO 2560-A E42 3 B 1 2
KR	3H10, 3Y H10
ABS	3H10, 3Y
LR	3, 3YH15
BV	3, 3YHH
DNV	3YH10
GL	3YH10
NK	KMW53HH

## Applications

- Heavy steel fabrication
- Shipbuilding
- Pressure vessels

## Features

- Suitable for butt and fillet welding of heavy structure
- Good crack resistance and X-ray performance
- Good mechanical properties
- Low fume

## Typical Chemical Composition of All-Weld Metal (%)

C	Si	Mn	P	S
0.08	0.62	1.29	0.016	0.011

## Typical Mechanical Properties of All-Weld Metal

Condition	YS MPa(lbs/in <sup>2</sup> )	TS MPa(lbs/in <sup>2</sup> )	EL (%)	Temp °C(°F)	CVN-Impact Value J (ft.-lbs)
AW	550 (79,900)	605 (87,800)	29.0	-30 (-22)	75 (56)

## Typical Operating Procedures

Diameter mm (in)	2.6 (3/32)	3.2 (1/8)	4.0 (5/32)	5.0 (3/16)	6.0 (15/64)
Length mm (in)	350 (14)	350 (14)	400 (16)	400 (16)	450 (18)
F	55-85	90-130	130-180	180-240	250-310
V-up, OH	50-80	80-130	110-170	150-200	-

## Welding Position



1G 2F 3G 4G  
(PA) (PB) (PF) (PE)

## Current

AC or DC +

## Redrying Conditions

300~350°C (572~662°F) X  
0.5~1hr

## Diameter / Packaging

Diameter mm (in)	Length mm (in)	Standard	
		packet 5kg(11lbs)	carton 20kg(44lbs)
2.6 (3/32)	350 (14)	✓	
3.2 (1/8)	350 (14)	✓	
4.0 (5/32)	400 (16)	✓	
5.0 (3/16)	400 (16)	✓	
6.0 (15/64)	450 (18)	✓	

SMAW

SAW

GMAW

GTAW

FCAW

Non-FERROUS

APPENDIX

# S-7016.G

Type : Basic

## Conformances

AWS A5.1/ ASME SFA5.1 E7016

JIS Z3211 E4916

EN ISO 2560-A E42 3 B 1 2

## Applications

- Heavy steel fabrication
- Shipbuilding
- Pressure vessels

## Features

- Suitable for butt and fillet welding of heavy structure
- Good crack resistance and X-ray performance
- Good mechanical properties

## Welding Position



1G 2F 3G 4G  
(PA) (PB) (PF) (PE)

## Current

AC or DC +

## Redrying Conditions

300~350°C (572~662°F) X

0.5~1hr

## Diameter / Packaging

Diameter mm (in)	Length mm (in)	Standard	
		packet 5kg(11lbs)	carton 20kg(44lbs)
2.6 (3/32)	350 (14)		✓
3.2 (1/8)	350 (14)		✓
4.0 (5/32)	400 (16)		✓
5.0 (3/16)	400 (16)		✓
6.0 (15/64)	450 (18)		✓

## Typical Chemical Composition of All-Weld Metal (%)

C	Si	Mn	P	S
0.08	0.66	1.40	0.017	0.011

## Typical Mechanical Properties of All-Weld Metal

Condition	YS MPa(lbs/in <sup>2</sup> )	TS MPa(lbs/in <sup>2</sup> )	EL (%)	Temp °C(°F)	CVN-Impact Value J (ft.lbs)
AW	560 (81,300)	641 (93,100)	30.4	-30 (-22)	68 (50)

## Typical Operating Procedures

Diameter mm (in)	2.6 (3/32)	3.2 (1/8)	4.0 (5/32)	5.0 (3/16)	6.0 (15/64)
Length mm (in)	350 (14)	350 (14)	400 (16)	400 (16)	450 (18)
F	55-90	90-130	130-180	180-240	250-310
V-up, OH	50-80	85-120	110-170	150-200	-



# S-7018.G

Type : Basic

## Conformances

AWS A5.1/ ASME SFA5.1 E7018  
 JIS Z3211 E4918  
 EN ISO 2560-A E42 3 B 1 2  
 KR 3H10, 3Y H10  
 ABS 3H10, 3Y  
 LR 3, 3YH15  
 BV 3YHH  
 DNV 3YH10  
 GL 3YH10  
 NK KMW53HH  
 NAKS

## Applications

- Heavy steel fabrication
- Shipbuilding
- Pressure vessels

## Features

- Suitable for butt and fillet welding of heavy structure
- Good crack resistance and X-ray performance
- Good mechanical properties
- Iron powder and low hydrogen type electrode (high efficiency)

## Typical Chemical Composition of All-Weld Metal (%)

C	Si	Mn	P	S
0.06	0.50	1.20	0.017	0.011

Condition	YS MPa(lbs/in <sup>2</sup> )	TS MPa(lbs/in <sup>2</sup> )	EL (%)	Temp °C(°F)	CVN-Impact Value J (ft.-lbs)
AW	504 (73,200)	572 (83,100)	29.8	-30 (-22)	111 (82)

## Typical Operating Procedures

Diameter mm (in)	2.6 (3/32)	3.2 (1/8)	4.0 (5/32)	5.0 (3/16)	5.5 (7/32)	6.0 (15/64)
Length mm (in)	350 (14)	350 (14)	400 (16)	400 (16)	450 (18)	450 (18)
	-	400 (16)	450 (18)	450 (18)	450 (18)	450 (18)
F	60-90	90-140	130-190	180-240	220-260	250-300
V-up, OH	50-80	80-120	120-170	150-200	-	-

## Welding Position



1G 2F 3G 4G  
 (PA) (PB) (PF) (PE)

## Current

AC or DC +

## Redrying Conditions

300~350°C (572~662°F) X 0.5~1hr

## Diameter / Packaging

Diameter mm (in)	Length mm (in)	Standard / P.V.C	
		packet 5kg(11lbs)	carton 20kg(44lbs)
2.6 (3/32)	350 (14)	✓	
3.2 (1/8)	350 (14)	✓	
4.0 (5/32)	400 (16)	✓	
5.0 (3/16)	400 (16)	✓	
5.5 (7/32)	450 (18)	✓	
6.0 (15/64)	450 (18)	✓	

SMAW

SAW

GM/AW

GTAW

FCAW

Non-FERROUS

APPENDIX

# S-7018.GH

Type : Basic

## Conformances

AWS A5.1/ ASME SFA5.1 E7018  
 JIS Z3211 E4918 H5  
 EN ISO 2560-A E42 3 B 3 2 H5

CWB CSA W48 E4918

## Applications

- Heavy steel fabrication
- Shipbuilding
- Pressure vessels

## Features

- Low hydrogen electrode
- Iron powder and low hydrogen type electrode (high efficiency)
- Good mechanical properties
- Vacuum sealed package available (HDM ≤ 5ml/100g)

## Welding Position

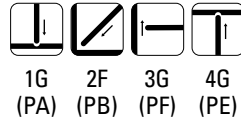

## Current

AC or DC +

## Redrying Conditions

300~350°C (572~662°F) X  
 0.5~1hr

## Diameter / Packaging

Diameter	Length	Standard		Vacuum				P.V.C	
		packet	carton	packet	carton	packet	carton	packet	carton
mm (in)	mm (in)	5kg(11lbs)	20kg(44lbs)	1.5kg(3.3lbs)	15kg(3.3lbs)	5kg(11lbs)	20kg(44lbs)	5kg(11lbs)	20kg(44lbs)
2.6 (3/32)	350 (14)	✓		✓		✓		✓	
3.2 (1/8)	350 (14)	✓		✓		✓		✓	
4.0 (5/32)	400 (16)	✓		✓		✓		✓	
5.0 (3/16)	400 (16)	✓		✓		✓		✓	
6.0 (15/64)	450 (18)	✓		✓		✓		✓	

**Typical Chemical Composition of All-Weld Metal (%)**

C	Si	Mn	P	S
0.07	0.42	1.21	0.018	0.006

**Typical Mechanical Properties of All-Weld Metal**

Condition	YS MPa(lbs/in <sup>2</sup> )	TS MPa(lbs/in <sup>2</sup> )	EL (%)	Temp °C(°F)	CVN-Impact Value J (ft-lbs)
AW	488 (70,800)	566 (82,100)	27.4	-30 (-22)	126 (93)

**Typical Operating Procedures**

Diameter mm (in)	2.6 (3/32)	3.2 (1/8)	4.0 (5/32)	5.0 (3/16)	6.0 (15/64)
Length mm (in)	350 (14) -	350 (14) 400 (16)	400 (16) 450 (18)	400 (16) 450 (18)	450 (18)
F	60-90	90-140	130-190	180-240	250-300
V-up, OH	50-80	80-120	120-170	150-200	-

SMAW

SAW

GMAW

GTAW

FCAW

Non-FERROUS

APPENDIX

# S-7028.F

Type : High recovery Basic

## Conformances

AWS A5.1/ ASME SFA5.1 E7028  
JIS Z3211 E4928  
EN ISO 2560-A E42 2 B 7 4  
KR 3Y  
ABS 3, 3Y

LR 3, 3Y, 3YG  
BV 3, 3Y  
DNV 3 (25 t)  
GL 3Y  
NK KMW3, KMW53

## Applications

- Heavy steel fabrication

## Features

- Heavy iron powder type electrode
- High deposition rate
- Easy to remove slag

## Welding Position



1G 2F  
(PA) (PB)

## Current

AC or DC +

## Redrying Conditions

300~350°C (572~662°F) X  
0.5~1hr

## Diameter / Packaging

Diameter	Length	Standard		Vacuum				P.V.C	
		packet	carton	packet	carton	packet	carton	packet	carton
4.0 (5/32)	550 (22)		√						
4.5 (11/64)	550 (22)		√						
	700 (28)								
5.0 (3/16)	700 (28)		√						
5.5 (7/32)	700 (28)		√						
6.0 (15/64)	700 (28)		√						
	6.4 (1/4)		√						
7.0 (9/32)	700 (28)		√						

### Typical Chemical Composition of All-Weld Metal (%)

C	Si	Mn	P	S
0.07	0.29	1.08	0.027	0.015

### Typical Mechanical Properties of All-Weld Metal

Condition	YS MPa(lbs/in <sup>2</sup> )	TS MPa(lbs/in <sup>2</sup> )	EL (%)	Temp °C(°F)	CVN-Impact Value J (ft-lbs)
AW	478 (69,400)	546 (79,300)	32.0	-20 (-4)	63 (47)

### Typical Operating Procedures

Diameter mm (in)	4.0 (5/32)	4.5 (11/64)	5.0 (3/16)	5.5 (7/32)	6.0 (15/64)	6.4 (1/4)	7.0 (9/32)
Length mm (in)	550 (22)	550 (22) 700 (28)	700 (28)	700 (28)	700 (28)	700 (28)	700 (28)
F	150-220	170-220	190-250	220-280	260-320	270-340	330-360

SMAW

SAW

GMAW

GTAW

FCAW

Non-FERROUS

APPENDIX

# S-7048.V

Type : Basic

## Conformances

AWS A5.1/ ASME SFA5.1 E7048  
 JIS Z3211 E4948  
 EN ISO 2560-A E42 3 B 3 5  
 KR 3H10, 3YH10  
 ABS 3H10, 3Y  
 LR 3, 3YH15  
 BV 3, 3YHH  
 DNV 3YH10  
 GL 3YH10  
 NK KMW53HH

## Applications

- Heavy steel fabrication
- Automotive
- Machinery

## Features

- Suitable for tack welding
- Good at vertical down
- Good restriking
- Good bead appearance
- Easy to remove slag

## Welding Position

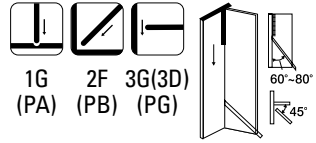

## Current

AC or DC +

## Redrying Conditions

300~350°C (572~662°F) X  
 0.5~1hr

## Diameter / Packaging

Diameter mm (in)	Length mm (in)	Standard	
		packet 5kg(11lbs)	carton 20kg(44lbs)
2.6 (3/32)	350 (14)		✓
3.2 (1/8)	350 (14)		✓
4.0 (5/32)	400 (16)		✓
5.0 (3/16)	400 (16)		✓

## Typical Chemical Composition of All-Weld Metal (%)

C	Si	Mn	P	S
0.06	0.54	1.05	0.011	0.009

## Typical Mechanical Properties of All-Weld Metal

Condition	YS MPa(lbs/in <sup>2</sup> )	TS MPa(lbs/in <sup>2</sup> )	EL (%)	Temp °C(°F)	CVN-Impact Value J (ft.-lbs)
AW	473 (68,700)	564 (81,900)	30.8	-30 (-22)	68 (50)

## Typical Operating Procedures

Diameter mm (in)	3.2 (1/8)	4.0 (5/32)	4.5 (11/64)	5.0 (3/16)
Length mm (in)	400 (16)	450 (18)	450 (18)	450 (18)
F, V-down	100~160	140~210	180~240	220~270

# S-8016.G

Type : Basic

## Conformances

AWS A5.5/ ASME SFA5.5 E8016-G  
 JIS Z3211 E5516  
 EN ISO 2560-A E46 3 1Ni B 1 2  
 ABS AWS A5.5 E8016-G

## Applications

- Heavy steel fabrication
- Shipbuilding
- Offshore structure

## Features

- Good bead appearance
- Good crack resistance
- Good X-ray performance
- Good mechanical properties

## Welding Position



1G 2F 3G 4G  
 (PA) (PB) (PF) (PE)

## Current

AC or DC +

## Redrying Conditions

300~350°C (572~662°F) X  
 0.5~1hr

## Diameter / Packaging

Diameter mm (in)	Length mm (in)	Standard	
		packet 5kg(11lbs)	carton 20kg(44lbs)
2.6 (3/32)	350 (14)	✓	
3.2 (1/8)	350 (14)	✓	
4.0 (5/32)	400 (16)	✓	
5.0 (3/16)	400 (16)	✓	
6.0 (15/64)	450 (18)	✓	

## Typical Chemical Composition of All-Weld Metal (%)

C	Si	Mn	P	S	Ni
0.08	0.34	1.44	0.011	0.009	0.94

## Typical Mechanical Properties of All-Weld Metal

Condition	YS MPa(lbs/in <sup>2</sup> )	TS MPa(lbs/in <sup>2</sup> )	EL (%)	Temp °C(°F)	CVN-Impact Value J (ft.-lbs)
AW	519 (75,400)	613 (89,000)	28.8	-20 (-4) -30 (-22)	160 (119) 141 (104)

## Typical Operating Procedures

Diameter mm (in)	2.6 (3/32)	3.2 (1/8)	4.0 (5/32)	5.0 (3/16)	6.0 (15/64)
Length mm (in)	350 (14)	350 (14)	400 (16)	400 (16)	450 (18)
F	55~90	90~130	130~180	180~240	250~310
V-up, OH	50~80	85~120	110~170	150~200	-

SMW

SAW

GMAW

GTAW

FCAW

Non-FERROUS

APPENDIX

# S-8018.G

Type : Basic

## Conformances

AWS A5.5/ ASME SFA5.5 E8018-G

JIS Z3211 E5518

EN ISO 2560-A E46 2 1Ni B 3 2

## Applications

- Heavy steel fabrication
- Shipbuilding
- Offshore structure

## Features

- Good bead appearance
- Good crack resistance
- Good X-ray performance
- Good mechanical properties
- Iron powder and low hydrogen type electrode (high efficiency)

## Welding Position



1G 2F 3G 4G  
(PA) (PB) (PF) (PE)

## Current

AC or DC +

## Redrying Conditions

300~350°C (572~662°F) X

0.5~1hr

## Diameter / Packaging

Diameter mm (in)	Length mm (in)	Standard	
		packet 5kg(11lbs)	carton 20kg(44lbs)
2.6 (3/32)	350 (14)		✓
3.2 (1/8)	350 (14)		✓
4.0 (5/32)	400 (16)		✓
5.0 (3/16)	400 (16)		✓
6.0 (15/64)	450 (18)		✓

## Typical Chemical Composition of All-Weld Metal (%)

C	Si	Mn	P	S	Ni
0.07	0.61	1.29	0.016	0.012	0.83

## Typical Mechanical Properties of All-Weld Metal

Condition	YS MPa(lbs/in <sup>2</sup> )	TS MPa(lbs/in <sup>2</sup> )	EL (%)	Temp °C(°F)	CVN-Impact Value J (ft.lbs)
AW	542 (78,700)	622 (90,300)	30.2	0 (32) -20 (-4)	147 (109) 103 (76)

## Typical Operating Procedures

Diameter mm (in)	2.6 (3/32)	3.2 (1/8)	4.0 (5/32)	5.0 (3/16)	6.0 (15/64)
Length mm (in)	350 (14)	350 (14)	400 (16)	400 (16)	450 (18)
F	60-90	90-140	130-190	180-240	250-300
V-up, OH	50-80	80-120	120-170	150-200	-



# S-9016.G

Type : Basic

## Conformances

AWS A5.5/ ASME SFA5.5 E9016-G  
 JIS Z3211 E5716  
 EN ISO 2560-A E50 2 B 1 2  
 ABS AWS A5.5 E9016-G

## Applications

- Heavy steel fabrication
- Shipbuilding
- Offshore structure

## Features

- Good bead appearance
- Good crack resistance
- Good X-ray performance
- Good mechanical properties

## Welding Position



1G 2F 3G 4G  
 (PA) (PB) (PF) (PE)

## Current

AC or DC +

## Redrying Conditions

300~350°C (572~662°F) X  
 0.5~1hr

## Diameter / Packaging

Diameter mm (in)	Length mm (in)	Standard	
		packet 5kg(11lbs)	carton 20kg(44lbs)
2.6 (3/32)	350 (14)		✓
3.2 (1/8)	350 (14)		✓
4.0 (5/32)	400 (16)		✓
5.0 (3/16)	400 (16)		✓
6.0 (15/64)	450 (18)		✓

## Typical Chemical Composition of All-Weld Metal (%)

C	Si	Mn	P	S	Ni	Mo
0.06	0.52	1.09	0.016	0.010	0.56	0.23

## Typical Mechanical Properties of All-Weld Metal

Condition	YS MPa(lbs/in <sup>2</sup> )	TS MPa(lbs/in <sup>2</sup> )	EL (%)	Temp °C(°F)	CVN-Impact Value J (ft.-lbs)
AW	570 (82,800)	655 (95,100)	27.2	0 (32) -20 (-4)	125 (93) 78 (58)

## Typical Operating Procedures

Diameter mm (in)	2.6 (3/32)	3.2 (1/8)	4.0 (5/32)	5.0 (3/16)	6.0 (15/64)
Length mm (in)	350 (14)	350 (14)	400 (16)	400 (16)	450 (18)
F	55~90	90~130	130~180	180~240	250~310
V-up, OH	50~80	85~120	110~170	150~200	-

SWAW

SAW

GMAW

GTAW

FCAW

Non-FERROUS

APPENDIX

# S-10016.G

Type : Basic

## Conformances

AWS A5.5/ ASME SFA5.5 E10016-G  
 JIS Z3211 E6916-N4CM1 U  
 EN 757 E55 0 B 1 2  
 ABS AWS A5.5 E10016-G

## Applications

- Heavy steel fabrication
- Pressure vessels
- Power plant

## Features

- Good crack resistance
- Good X-ray performance
- Good mechanical properties

## Welding Position



1G 2F 3G 4G  
 (PA) (PB) (PF) (PE)

## Current

AC or DC +

## Redrying Conditions

300~350°C (572~662°F) X  
 0.5~1hr

## Diameter / Packaging

Diameter mm (in)	Length mm (in)	Standard	
		packet 5kg(11lbs)	carton 20kg(44lbs)
2.6 (3/32)	350 (14)		✓
3.2 (1/8)	350 (14)		✓
4.0 (5/32)	400 (16)		✓
5.0 (3/16)	400 (16)		✓
6.0 (15/64)	450 (18)		✓

## Typical Chemical Composition of All-Weld Metal (%)

C	Si	Mn	P	S	Ni	Mo
0.07	0.69	1.41	0.013	0.012	1.49	0.12

## Typical Mechanical Properties of All-Weld Metal

Condition	YS MPa(lbs/in <sup>2</sup> )	TS MPa(lbs/in <sup>2</sup> )	EL (%)	Temp °C(°F)	CVN-Impact Value J (ft.lbs)
AW	710 (103,130)	762 (110,680)	24.0	0 (32)	110 (81)

## Typical Operating Procedures

Diameter mm (in)	2.6 (3/32)	3.2 (1/8)	4.0 (5/32)	5.0 (3/16)	6.0 (15/64)
Length mm (in)	350 (14)	350 (14)	400 (16)	400 (16)	450 (18)
F	55~90	90~130	130~180	170~240	250~310
V-up, OH	50~80	85~120	110~170	150~200	-

# S-11016.G

Type : Basic

## Conformances

AWS A5.5/ ASME SFA5.5 E11016-G  
 EN 757 E62 2 Mn2NiMo B 1 2  
 ABS AWS A5.5 E11016-G

## Applications

- Heavy steel fabrication
- Pressure vessels
- Power plant

## Features

- Good crack resistance
- Good mechanical properties

## Welding Position



1G 2F 3G 4G  
 (PA) (PB) (PF) (PE)

## Current

AC or DC +

## Redrying Conditions

300~350°C (572~662°F) X  
 0.5~1hr

## Diameter / Packaging

Diameter mm (in)	Length mm (in)	Standard	
		packet 5kg(11lbs)	carton 20kg(44lbs)
2.6 (3/32)	350 (14)		✓
3.2 (1/8)	350 (14)		✓
4.0 (5/32)	400 (16)		✓
5.0 (3/16)	400 (16)		✓
6.0 (15/64)	450 (18)		✓

## Typical Chemical Composition of All-Weld Metal (%)

C	Si	Mn	P	S	Cr	Ni	Mo
0.07	0.45	1.56	0.017	0.013	0.20	2.25	0.40

## Typical Mechanical Properties of All-Weld Metal

Condition	YS MPa(lbs/in <sup>2</sup> )	TS MPa(lbs/in <sup>2</sup> )	EL (%)	Temp °C(°F)	CVN-Impact Value J (ft.-lbs)
AW	760 (110,300)	790 (114,600)	24.0	-20 (-4)	130 (96)

## Typical Operating Procedures

Diameter mm (in)	2.6 (3/32)	3.2 (1/8)	4.0 (5/32)	5.0 (3/16)	6.0 (15/64)
Length mm (in)	350 (14)	350 (14)	400 (16)	400 (16)	450 (18)
F	60~90	90~130	130~180	180~240	250~310
V-up, OH	50~80	85~120	110~170	150~200	-

SWAW

SAW

GMAW

GTAW

FCAW

Non-FERROUS

APPENDIX

# S-9018.M

Type : Basic

## Conformances

AWS A5.5/ ASME SFA5.5 E9018-M

EN 757 E50 4 B 4 2

ABS AWS A5.5 E9018-M

## Applications

- Heavy steel fabrication
- Pressure vessels

## Features

- Good crack resistance
- Good X-ray performance
- Good impact value at -50°C
- Iron powder and low hydrogen type electrode (high efficiency)

## Welding Position



1G 2F 3G 4G  
(PA) (PB) (PF) (PE)

## Current

AC or DC +

## Redrying Conditions

300~350°C (572~662°F) X

0.5~1hr

## Diameter / Packaging

Diameter mm (in)	Length mm (in)	Standard	
		packet 5kg(11lbs)	carton 20kg(44lbs)
2.6 (3/32)	350 (14)		✓
3.2 (1/8)	350 (14)		✓
4.0 (5/32)	400 (16)		✓
5.0 (3/16)	400 (16)		✓
6.0 (15/64)	450 (18)		✓

## Typical Chemical Composition of All-Weld Metal (%)

C	Si	Mn	P	S	Ni	Mo
0.05	0.46	1.21	0.017	0.011	1.47	0.22

## Typical Mechanical Properties of All-Weld Metal

Condition	YS MPa(lbs/in <sup>2</sup> )	TS MPa(lbs/in <sup>2</sup> )	EL (%)	Temp °C(°F)	CVN-Impact Value J (ft.lbs)
AW	585 (85,000)	646 (93,800)	27.6	-50 (-58)	89 (66)

## Typical Operating Procedures

Diameter mm (in)	2.6 (3/32)	3.2 (1/8)	4.0 (5/32)	5.0 (3/16)	6.0 (15/64)
Length mm (in)	350 (14)	350 (14)	400 (16)	400 (16)	450 (18)
F	70~100	90~140	130~190	180~240	250~300
V-up, OH	60~80	80~120	120~170	150~200	-

# S-11018.M

Type : Basic

## Conformances

AWS A5.5/ ASME SFA5.5 E11018-M

EN 757 E62 4 B 4 2

ABS AWS A5.5 E11018-M

## Applications

- Low alloy high tensile steels

## Features

- Iron powder and low hydrogen type electrode (high efficiency)
- Good crack resistance
- Good X-ray performance
- Good impact value at -50°C

## Welding Position



1G 2F 3G 4G  
(PA) (PB) (PF) (PE)

## Current

AC or DC +

## Redrying Conditions

300~350°C (572~662°F) X

0.5~1hr

## Diameter / Packaging

Diameter mm (in)	Length mm (in)	Standard	
		packet 5kg(11lbs)	carton 20kg(44lbs)
2.6 (3/32)	350 (14)		✓
3.2 (1/8)	350 (14)		✓
4.0 (5/32)	400 (16)		✓
5.0 (3/16)	400 (16)		✓
6.0 (15/64)	450 (18)		✓

## Typical Chemical Composition of All-Weld Metal (%)

C	Si	Mn	P	S	Cr	Ni	Mo
0.07	0.48	1.62	0.023	0.012	0.21	2.04	0.35

## Typical Mechanical Properties of All-Weld Metal

Condition	YS MPa(lbs/in <sup>2</sup> )	TS MPa(lbs/in <sup>2</sup> )	EL (%)	Temp °C(°F)	CVN-Impact Value J (ft.-lbs)
AW	722 (104,900)	796 (115,600)	21.6	-50 (-58)	50 (37)

## Typical Operating Procedures

Diameter mm (in)	2.6 (3/32)	3.2 (1/8)	4.0 (5/32)	5.0 (3/16)	6.0 (15/64)
Length mm (in)	350 (14)	350 (14)	400 (16)	400 (16)	450 (18)
F	55~90	90~130	130~190	190~240	250~300
V-up, OH	50~80	80~120	120~170	150~200	-

SMAW

SAW

GMAW

GTAW

FCAW

Non-FERROUS

APPENDIX

# S-7018.W

Type : Basic

## Conformances

AWS A5.5/ ASME SFA5.5 E7018-W1

JIS Z3214 DA5026G

EN ISO 2560-A E42 2 B 3 2

## Applications

- High tensile weathering steel

## Features

- Suitable for off- and on-shore construction
- High resistance to corrosion caused by seawater or combinations of oil, gas and seawater
- Contains Cu, Ni and Cr (All-weld metal)

## Welding Position



1G 2F 3G 4G  
(PA) (PB) (PF) (PE)

## Current

AC or DC +

## Redrying Conditions

300~350°C (572~662°F) X

0.5~1hr

## Diameter / Packaging

Diameter mm (in)	Length mm (in)	Standard	
		packet 5kg(11lbs)	carton 20kg(44lbs)
2.6 (3/32)	350 (14)		✓
3.2 (1/8)	350 (14)		✓
4.0 (5/32)	400 (16)		✓
5.0 (3/16)	400 (16)		✓
6.0 (15/64)	450 (18)		✓

## Typical Chemical Composition of All-Weld Metal (%)

C	Si	Mn	P	S	Cr	Ni	Cu
0.05	0.56	0.62	0.015	0.013	0.24	0.23	0.37

## Typical Mechanical Properties of All-Weld Metal

Condition	YS MPa(lbs/in <sup>2</sup> )	TS MPa(lbs/in <sup>2</sup> )	EL (%)	Temp °C(°F)	CVN-Impact Value J (ft.lbs)
AW	505 (73,300)	573 (83,200)	31.3	-20 (-4)	100 (74)

## Typical Operating Procedures

Diameter mm (in)	2.6 (3/32)	3.2 (1/8)	4.0 (5/32)	5.0 (3/16)	6.0 (15/64)
Length mm (in)	350 (14)	350 (14)	400 (16)	400 (16)	450 (18)
F	60~90	90~140	130~190	180~240	250~300
V-up, OH	50~80	80~120	120~170	150~200	-

# S-8018.W

Type : Basic

## Conformances

AWS A5.5/ ASME SFA5.5 E8018-W2

JIS Z3214 DA5826W

EN ISO 2560-A E50 2 B 3 2

## Applications

- High tensile weathering steel

## Features

- Suitable for off- and on-shore construction
- High resistance to corrosion caused by seawater or combinations of oil, gas and seawater
- Contains Cu, Ni and Cr (All-weld metal)

## Welding Position



1G (PA) 2F (PB) 3G (PF) 4G (PE)

## Current

AC or DC +

## Redrying Conditions

300~350°C (572~662°F) X

0.5~1hr

## Diameter / Packaging

Diameter mm (in)	Length mm (in)	Standard	
		packet 5kg(11lbs)	carton 20kg(44lbs)
2.6 (3/32)	350 (14)	✓	
3.2 (1/8)	350 (14)	✓	
4.0 (5/32)	400 (16)	✓	
5.0 (3/16)	400 (16)	✓	
6.0 (15/64)	450 (18)	✓	

## Typical Chemical Composition of All-Weld Metal (%)

C	Si	Mn	P	S	Cr	Ni	Cu
0.06	0.54	0.95	0.014	0.011	0.56	0.57	0.38

## Typical Mechanical Properties of All-Weld Metal

Condition	YS MPa(lbs/in <sup>2</sup> )	TS MPa(lbs/in <sup>2</sup> )	EL (%)	Temp °C(°F)	CVN-Impact Value J (ft-lbs)
AW	604 (87,700)	648 (94,100)	27.4	-20 (-4)	117 (87)

## Typical Operating Procedures

Diameter mm (in)	2.6 (3/32)	3.2 (1/8)	4.0 (5/32)	5.0 (3/16)	6.0 (15/64)
Length mm (in)	350 (14)	350 (14)	400 (16)	400 (16)	450 (18)
F	60~90	90~140	130~190	180~240	250~300
V-up, OH	50~80	80~120	120~170	150~200	-

SWAW

SAW

GMAW

GTAW

FCAW

Non-FERROUS

APPENDIX

# S-7018.1

Type : Basic

## Conformances

AWS A5.1/ ASME SFA5.1 E7018-1  
 JIS Z3211 E4918  
 EN ISO 2560-A E42 4 B 3 2  
 ABS 3H10, 3Y  
 BV 3Y HH  
 LR 3, 3Y H15  
 DNV 3Y H10  
 GL 3Y H10  
 RINA 3Y H10

## Applications

- Heavy steel fabrication
- Low temperature strength steel
- Offshore structure

## Features

- Suitable for butt and fillet welding of thin and medium-thick plates (up to 20mm)
- Iron powder and low hydrogen type electrode (high efficiency)
- Good impact value at -45°C

## Welding Position



1G 2F 3G 4G  
 (PA) (PB) (PF) (PE)

## Current

AC or DC +

## Redrying Conditions

300~350°C (572~662°F) X  
 0.5~1hr

## Diameter / Packaging

Diameter mm (in)	Length mm (in)	Standard / P.V.C	
		packet 5kg(11lbs)	carton 20kg(44lbs)
2.6 (3/32)	350 (14)		✓
3.2 (1/8)	350 (14)		✓
4.0 (5/32)	400 (16)		✓
5.0 (3/16)	400 (16)		✓
6.0 (15/64)	450 (18)		✓

## Typical Chemical Composition of All-Weld Metal (%)

C	Si	Mn	P	S
0.06	0.25	1.25	0.017	0.012

## Typical Mechanical Properties of All-Weld Metal

Condition	YS MPa(lbs/in <sup>2</sup> )	TS MPa(lbs/in <sup>2</sup> )	EL (%)	Temp °C(°F)	CVN-Impact Value J (ft.lbs)
AW	480 (69,700)	550 (79,800)	30.2	-45 (-49)	94 (70)

## Typical Operating Procedures

Diameter mm (in)	2.6 (3/32)	3.2 (1/8)	4.0 (5/32)	5.0 (3/16)	6.0 (15/64)
Length mm (in)	350 (14)	350 (14)	400 (16)	400 (16)	450 (18)
F	60~90	90~140	130~190	180~240	250~300
V-up, OH	50~80	80~120	120~170	150~200	-



# S-7018.1H

Type : Basic

## Conformances

AWS A5.1/ ASME SFA5.1 E7018-1 H4R  
 JIS Z3211 E4918 H5  
 EN ISO 2560-A E42 4 B 3 2 H5  
 ABS 4Y H5  
 LR 4Y H5

BV 4Y HHH  
 DNV 4YH5  
 GL 4YH5  
 CWB CSA W48 E4918-1

## Applications

- Heavy steel fabrication
- Low temperature strength steel
- Offshore structure

## Features

- Extra low hydrogen electrode
- Good impact value at -45°C
- Vacuum sealed package available (HDM ≤ 4ml/100g)

## Welding Position



1G 2F 3G 4G  
 (PA) (PB) (PF) (PE)

## Current

AC or DC +

## Redrying Conditions

300~350°C (572~662°F) X  
 0.5~1hr

## Diameter / Packaging

Diameter	Length	Standard		Vacuum				P.V.C	
		packet	carton	packet	carton	packet	carton	packet	carton
mm (in)	mm (in)	5kg(11lbs)	20kg(44lbs)	1.5kg(3.3lbs)	15kg(3.3lbs)	5kg(11lbs)	20kg(44lbs)	5kg(11lbs)	20kg(44lbs)
2.6 (3/32)	350 (14)	✓		✓		✓		✓	
3.2 (1/8)	350 (14)	✓		✓		✓		✓	
4.0 (5/32)	400 (16)	✓		✓		✓		✓	
5.0 (3/16)	400 (16)	✓		✓		✓		✓	

SMAW

SAW

GMAW

GTAW

FCAW

Non-FERROUS

APPENDIX

**Typical Chemical Composition of All-Weld Metal (%)**

C	Si	Mn	P	S
0.06	0.25	1.35	0.014	0.005

**Typical Mechanical Properties of All-Weld Metal**

Condition	YS MPa(lbs/in <sup>2</sup> )	TS MPa(lbs/in <sup>2</sup> )	EL (%)	Temp °C(°F)	CVN-Impact Value J (ft-lbs)
AW	493 (71,500)	566 (82,100)	30.8	-45 (-49)	152 (112)

**Typical Operating Procedures**

Diameter mm (in)	2.6 (3/32)	3.2 (1/8)	4.0 (5/32)	5.0 (3/16)
Length mm (in)	350 (14)	400 (16)	450 (18)	450 (18)
F	60-90	90-140	130-190	180-240
V-up, OH	50-80	80-120	120-170	150-200

# S-76LTH

Type : Basic

## Conformances

AWS A5.5/ ASME SFA5.5 E7016-G  
 JIS Z3211 E4916-N1 AP L  
 EN ISO 2560-A E42 6 Z B H5

ABS 5Y, 5Y400 H5  
 DNV 5Y40H5  
 NV4-4L

## Applications

- Low temperature strength steel
- Offshore structure
- LPG, LNG storage tank

## Features

- Low hydrogen electrode (HDM ≤ 5ml/100g)
- Good impact value at -60°C
- CTOD properties at -40°C (-40°F) temperature

## Welding Position

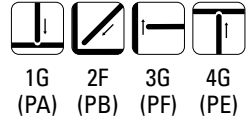

## Current

AC or DC +

## Redrying Conditions

300~350°C (572~662°F) X  
 0.5~1hr

## Diameter / Packaging

Diameter mm (in)	Length mm (in)	Standard		Vacuum				P.V.C	
		packet 5kg(11lbs)	carton 20kg(44lbs)	packet 1.5kg(3.3lbs)	carton 15kg(3.3lbs)	packet 5kg(11lbs)	carton 20kg(44lbs)	packet 5kg(11lbs)	carton 20kg(44lbs)
2.6 (3/32)	350 (14)	✓		✓		✓		✓	
3.2 (1/8)	350 (14)	✓		✓		✓		✓	
4.0 (5/32)	400 (16)	✓		✓		✓		✓	
5.0 (3/16)	400 (16)	✓		✓		✓		✓	

SMW

SAW

GMW

GTAW

FCW

Non-FERROUS

APPENDIX

### Typical Chemical Composition of All-Weld Metal (%)

C	Si	Mn	P	S	Ni	Ti	B
0.08	0.35	1.35	0.013	0.004	0.45	0.018	0.0015

### Typical Mechanical Properties of All-Weld Metal

Condition	YS MPa(lbs/in <sup>2</sup> )	TS MPa(lbs/in <sup>2</sup> )	EL (%)	Temp °C(°F)	CVN-Impact Value J (ft-lbs)
AW	540 (78,400)	590 (85,600)	30.0	-46 (-51) -60 (-76)	190 (137) 100 (72)

### Typical Operating Procedures

Diameter mm (in)	2.6 (3/32)	3.2 (1/8)	4.0 (5/32)	5.0 (3/16)
Length mm (in)	350 (14)	400 (16)	450 (18)	450 (18)
F	60~90	90~140	130~190	180~240
V-up, OH	50~80	80~120	120~170	150~200

# S-78LTH

Type : Basic

## Conformances

AWS A5.5/ ASME SFA5.5 E7018-G

EN ISO 2560-A E46 5 1Ni B 3 2 H5

## Applications

- Low temperature strength steel
- Offshore structure
- LPG, LNG storage tank

## Features

- Low-Hydrogen electrode
- Iron powder and low hydrogen type electrode (high efficiency)
- Good impact value at -60°C
- Vacuum sealed package available (HDM ≤ 5ml/100g)

## Welding Position



1G (PA) 2F (PB) 3G (PF) 4G (PE)

## Current

AC or DC +

## Redrying Conditions

350~400°C (662~752°F) X 1hr

## Diameter / Packaging

Diameter	Length	Standard		Vacuum				P.V.C	
		packet	carton	packet	carton	packet	carton	packet	carton
mm (in)	mm (in)	5kg(11lbs)	20kg(44lbs)	1.5kg(3.3lbs)	15kg(3.3lbs)	5kg(11lbs)	20kg(44lbs)	5kg(11lbs)	20kg(44lbs)
2.6 (3/32)	350 (14)	✓		✓		✓		✓	
3.2 (1/8)	350 (14)	✓		✓		✓		✓	
4.0 (5/32)	400 (16)	✓		✓		✓		✓	
5.0 (3/16)	400 (16)	✓		✓		✓		✓	

SAW

SAW

GMAW

GTAW

FCAW

Non-FERROUS

APPENDIX

### Typical Chemical Composition of All-Weld Metal (%)

C	Si	Mn	P	S	Ni	Ti	B
0.06	0.23	1.25	0.015	0.004	0.73	0.023	0.003

### Typical Mechanical Properties of All-Weld Metal

Condition	YS MPa(lbs/in <sup>2</sup> )	TS MPa(lbs/in <sup>2</sup> )	EL (%)	Temp °C(°F)	CVN-Impact Value J (ft-lbs)
AW	525 (76,100)	600 (87,000)	32	-45 (-51) -60 (-76)	165 (121) 113 (83)

### Typical Operating Procedures

Diameter mm (in)	2.6 (3/32)	3.2 (1/8)	4.0 (5/32)	5.0 (3/16)
Length mm (in)	350 (14)	400 (16)	450 (18)	450 (18)
F	60~90	90~140	130~190	180~240
V-up, OH	50~80	80~120	120~170	150~200

# S-7016.LS

Type : Basic

## Conformances

AWS A5.5/ ASME SFA5.5 E7016-G H4R  
 JIS Z3211 E4916-N1 AP L  
 EN ISO 2560-A E46 6 1Ni B 1 2  
 KR 3H10, 3YH10 (-60°C ≥34 J)  
 ABS 3H10, 3Y (-60°C ≥34 J)

LR 5Y40H15  
 BV 3, 3YHH (-60°C ≥34 J)  
 DNV 5YH10

## Applications

- Low temperature strength steel
- Offshore structure
- LPG, LNG storage tank

## Features

- Extra low hydrogen electrode
- Good impact value at -60°C
- CTOD properties at -10°C (14°F) temperature
- Vacuum sealed package available (HDM ≤ 4ml/100g)

## Welding Position



1G 2F 3G 4G  
 (PA) (PB) (PF) (PE)

## Current

AC or DC +

## Redrying Conditions

300~350°C (572~662°F) X  
 0.5~1hr

## Diameter / Packaging

Diameter	Length	Standard		Vacuum				P.V.C	
		packet	carton	packet	carton	packet	carton	packet	carton
mm (in)	mm (in)	5kg(11lbs)	20kg(44lbs)	1.5kg(3.3lbs)	15kg(3.3lbs)	5kg(11lbs)	20kg(44lbs)	5kg(11lbs)	20kg(44lbs)
2.6 (3/32)	350 (14)	✓		✓		✓		✓	
3.2 (1/8)	350 (14)	✓		✓		✓		✓	
4.0 (5/32)	400 (16)	✓		✓		✓		✓	
5.0 (3/16)	400 (16)	✓		✓		✓		✓	

SWAW

SAW

GMAW

GTAW

FCAW

Non-FERROUS

APPENDIX

### Typical Chemical Composition of All-Weld Metal (%)

C	Si	Mn	P	S	Ni
0.06	0.30	0.98	0.013	0.008	0.80

### Typical Mechanical Properties of All-Weld Metal

Condition	YS MPa(lbs/in <sup>2</sup> )	TS MPa(lbs/in <sup>2</sup> )	EL (%)	Temp °C(°F)	CVN-Impact Value J (ft-lbs)
AW	538 (78,100)	589 (85,500)	30.0	-45 (-49) -60 (-76)	95 (70) 73 (54)

### Typical Operating Procedures

Diameter mm (in)	2.6 (3/32)	3.2 (1/8)	4.0 (5/32)	5.0 (3/16)	6.0 (15/64)
Length mm (in)	350 (14)	350 (14)	400 (16)	400 (16)	450 (18)
F	55-85	90-130	130-180	180-240	250-310
V-up, OH	50-80	80-115	110-170	150-200	-



# S-8016.C1

Type : Basic

## Conformances

AWS A5.5/ ASME SFA5.5 E8016-C1

JIS Z3211 E5516-N5 AP L

EN ISO 2560-A E46 5 2Ni B 1 2

## Applications

- Low temperature strength steel (2.5% Ni)
- Offshore structure

## Features

- Good impact value at -60°C

## Welding Position



1G (PA) 2F (PB) 3G (PF) 4G (PE)

## Current

AC or DC +

## Redrying Conditions

300~350°C (572~662°F) X

0.5~1hr

## Diameter / Packaging

Diameter mm (in)	Length mm (in)	Standard	
		packet 5kg(11lbs)	carton 20kg(44lbs)
2.6 (3/32)	350 (14)	✓	
3.2 (1/8)	350 (14)	✓	
4.0 (5/32)	400 (16)	✓	
5.0 (3/16)	400 (16)	✓	
6.0 (15/64)	450 (18)	✓	

## Typical Chemical Composition of All-Weld Metal (%)

C	Si	Mn	P	S	Ni
0.06	0.52	1.03	0.012	0.006	2.38

## Typical Mechanical Properties of All-Weld Metal

Condition	YS MPa(lbs/in <sup>2</sup> )	TS MPa(lbs/in <sup>2</sup> )	EL (%)	Temp °C(°F)	CVN-Impact Value J (ft.-lbs)	Heat Treatment
AW	515 (74,800)	592 (86,000)	32.0	-60 (-76)	116 (86)	605 (1121°F) X 1hr. S.R

## Typical Operating Procedures

Diameter mm (in)	2.6 (3/32)	3.2 (1/8)	4.0 (5/32)	5.0 (3/16)	6.0 (15/64)
Length mm (in)	350 (14)	350 (14)	400 (16)	400 (16)	450 (18)
F	55~90	90~130	130~190	190~240	250~300
V-up, OH	50~80	80~120	120~170	-	-

SMAW

SAW

GMAW

GTAW

FCAW

Non-FERROUS

APPENDIX

# S-8016.C2

Type : Basic

## Conformances

AWS A5.5/ ASME SFA5.5 E8016-C2

JIS Z3211 E5516-N7 AP L

EN ISO 2560-A E46 6 3Ni B 1 2

## Applications

- Low temperature strength steel (3.5% Ni)
- Offshore structure

## Features

- Good impact value at -60~-75°C

## Welding Position



1G 2F 3G 4G  
(PA) (PB) (PF) (PE)

## Current

AC or DC +

## Redrying Conditions

300~350°C (572~662°F) X

0.5~1hr

## Diameter / Packaging

Diameter mm (in)	Length mm (in)	Standard	
		packet 5kg(11lbs)	carton 20kg(44lbs)
2.6 (3/32)	350 (14)		✓
3.2 (1/8)	350 (14)		✓
4.0 (5/32)	400 (16)		✓
5.0 (3/16)	400 (16)		✓
6.0 (15/64)	450 (18)		✓

## Typical Chemical Composition of All-Weld Metal (%)

C	Si	Mn	P	S	Ni
0.06	0.50	0.90	0.011	0.006	3.20

## Typical Mechanical Properties of All-Weld Metal

Condition	YS MPa(lbs/in <sup>2</sup> )	TS MPa(lbs/in <sup>2</sup> )	EL (%)	Temp °C(°F)	CVN-Impact Value J (ft.-lbs)	Heat Treatment
AW	530 (77,000)	630 (91,000)	30.0	-75 (-103)	60 (44)	605 (1121°F) X 1hr. S.R

## Typical Operating Procedures

Diameter mm (in)	2.6 (3/32)	3.2 (1/8)	4.0 (5/32)	5.0 (3/16)	6.0 (15/64)
Length mm (in)	350 (14)	350 (14)	400 (16)	400 (16)	450 (18)
F	55-90	90-130	130-190	190-240	250-300
V-up, OH	50-80	80-120	120-170	-	-

# S-8016.C3

Type : Basic

## Conformances

AWS A5.5/ ASME SFA5.5 E8016-C3

JIS Z3211 E5516-N2

EN ISO 2560-A E46 4 1Ni B 1 2

## Applications

- Low temperature strength steel (1% Ni)
- Offshore structure

## Features

- Good impact value at -40°C

## Welding Position



1G (PA) 2F (PB) 3G (PF) 4G (PE)

## Current

AC or DC +

## Redrying Conditions

300~350°C (572~662°F) X

0.5~1hr

## Diameter / Packaging

Diameter mm (in)	Length mm (in)	Standard	
		packet 5kg(11lbs)	carton 20kg(44lbs)
2.6 (3/32)	350 (14)		✓
3.2 (1/8)	350 (14)		✓
4.0 (5/32)	400 (16)		✓
5.0 (3/16)	400 (16)		✓
6.0 (15/64)	450 (18)		✓

## Typical Chemical Composition of All-Weld Metal (%)

C	Si	Mn	P	S	Ni
0.06	0.54	1.12	0.015	0.006	0.96

## Typical Mechanical Properties of All-Weld Metal

Condition	YS MPa(lbs/in <sup>2</sup> )	TS MPa(lbs/in <sup>2</sup> )	EL (%)	Temp °C(°F)	CVN-Impact Value J (ft.-lbs)
AW	540 (78,400)	620 (90,000)	26.0	-40 (-40)	80 (59)

## Typical Operating Procedures

Diameter mm (in)	2.6 (3/32)	3.2 (1/8)	4.0 (5/32)	5.0 (3/16)	6.0 (15/64)
Length mm (in)	350 (14)	350 (14)	400 (16)	400 (16)	450 (18)
F	55~90	90~130	130~190	190~240	250~300
V-up, OH	50~80	80~120	120~170	-	-

SMAW

SAW

GMAW

GTAW

FCAW

Non-FERROUS

APPENDIX

# S-8018.C1

Type : Basic

## Conformances

AWS A5.5/ ASME SFA5.5 E8018-C1

JIS Z3211 E5518-N5 AP L

EN ISO 2560-A E46 5 1Ni B 3 2

## Applications

- Low temperature strength steel (2.5% Ni)
- Offshore structure

## Features

- Good impact value at -60°C
- Iron powder and low hydrogen type electrode (high efficiency)

## Welding Position



1G 2F 3G 4G  
(PA) (PB) (PF) (PE)

## Current

AC or DC +

## Redrying Conditions

300~350°C (572~662°F) X

0.5~1hr

## Diameter / Packaging

Diameter mm (in)	Length mm (in)	Standard	
		packet 5kg(11lbs)	carton 20kg(44lbs)
2.6 (3/32)	350 (14)		✓
3.2 (1/8)	350 (14)		✓
4.0 (5/32)	400 (16)		✓
5.0 (3/16)	400 (16)		✓
6.0 (15/64)	450 (18)		✓

## Typical Chemical Composition of All-Weld Metal (%)

C	Si	Mn	P	S	Ni
0.08	0.66	0.70	0.011	0.009	2.40

## Typical Mechanical Properties of All-Weld Metal

Condition	YS MPa(lbs/in <sup>2</sup> )	TS MPa(lbs/in <sup>2</sup> )	EL (%)	Temp °C(°F)	CVN-Impact Value J (ft.-lbs)	Heat Treatment
AW	518 (75,200)	593 (86,100)	30.2	-60 (-76)	78 (58)	605 (1121°F) X 1hr. S.R

## Typical Operating Procedures

Diameter mm (in)	3.2 (1/8)	4.0 (5/32)	5.0 (3/16)	6.0 (15/64)
Length mm (in)	350 (14)	400 (16)	400 (16)	450 (18)
F	90~130	130~180	190~240	250~300
V-up, OH	80~120	120~170	-	-

# S-8018.C3

Type : Basic

## Conformances

AWS A5.5/ ASME SFA5.5 E8018-C3

JIS Z3211 E5518-N2

EN ISO 2560-A E46 4 1Ni B 3 2

## Applications

- Low temperature strength steel (1% Ni)
- Offshore structure

## Features

- Good impact value at -40°C
- Iron powder and low hydrogen type electrode (high efficiency)

## Welding Position



1G (PA) 2F (PB) 3G (PF) 4G (PE)

## Current

AC or DC +

## Redrying Conditions

300~350°C (572~662°F) X

0.5~1hr

## Diameter / Packaging

Diameter mm (in)	Length mm (in)	Standard	
		packet 5kg(11lbs)	carton 20kg(44lbs)
2.6 (3/32)	350 (14)		✓
3.2 (1/8)	350 (14)		✓
4.0 (5/32)	400 (16)		✓
5.0 (3/16)	400 (16)		✓
6.0 (15/64)	450 (18)		✓

## Typical Chemical Composition of All-Weld Metal (%)

C	Si	Mn	P	S	Ni
0.07	0.59	1.00	0.020	0.009	0.94

## Typical Mechanical Properties of All-Weld Metal

Condition	YS MPa(lbs/in <sup>2</sup> )	TS MPa(lbs/in <sup>2</sup> )	EL (%)	Temp °C(°F)	CVN-Impact Value J (ft.-lbs)
AW	540 (78,400)	619 (89,900)	30.8	-40 (-40)	76 (56)

## Typical Operating Procedures

Diameter mm (in)	2.6 (3/32)	3.2 (1/8)	4.0 (5/32)	5.0 (3/16)	6.0 (15/64)
Length mm (in)	350 (14)	350 (14)	400 (16)	400 (16)	450 (18)
F	55~90	90~130	130~190	190~240	250~300
V-up, OH	50~80	80~120	120~170	-	-

SMAW

SAW

GMAW

GTAW

FCAW

Non-FERROUS

APPENDIX

# S-7010.A1

Type : Cellulesic

## Conformances

AWS A5.5/ ASME SFA5.5 E7010-A1  
 EN ISO 2560-A - E42 0 Mo C 1 5  
 ABS AWS A5.5 E7010-A1  
 LR 2Y

## Applications

- Low alloy steel (0.5% Mo)
- Pipe line

## Features

- Good X-ray performance
- Good mechanical properties

## Welding Position



5G Up/Down  
(PF-PG)

## Current

DC ±

## Redrying Conditions

70~100°C (158~212°F) X 0.5~1hr

## Diameter / Packaging

Diameter mm (in)	Length mm (in)	Standard	
		packet 5kg(11lbs)	carton 20kg(44lbs)
2.6 (3/32)	350 (14)		✓
3.2 (1/8)	350 (14)		✓
4.0 (5/32)	400 (16)		✓
5.0 (3/16)	400 (16)		✓

## Typical Chemical Composition of All-Weld Metal (%)

C	Si	Mn	P	S	Mo
0.09	0.12	0.32	0.015	0.015	0.61

## Typical Mechanical Properties of All-Weld Metal

YS MPa(lbs/in <sup>2</sup> )	TS MPa(lbs/in <sup>2</sup> )	EL (%)	Heat Treatment
552 (80,000)	575 (83,400)	28.4	620°C(1148°F) X 1hr. S.R

## Typical Operating Procedures

Diameter mm (in)	2.6 (3/32)	3.2 (1/8)	4.0 (5/32)	5.0 (3/16)
Length mm (in)	300 (12)	350 (14)	350 (14)	350 (14)
F & HF	55~80A	80~120A	120~160A	160~210A
V-up, OH	50~70A	70~110A	110~150A	-

# S-7016.A1

Type : Basic

## Conformances

AWS A5.5/ ASME SFA5.5 E7016-A1

JIS Z3223 E4916-1M3

EN 1599 - E Mo B 1 2

## Applications

- Low alloy steel (0.5% Mo)
- Pressure vessels

## Features

- Good mechanical properties
- Good bead appearance

## Welding Position



1G 2F 3G 4G  
(PA) (PB) (PF) (PE)

## Current

AC, DC ±

## Redrying Conditions

300~350°C (572~662°F) X

0.5~1hr

## Diameter / Packaging

Diameter mm (in)	Length mm (in)	Standard	
		packet 5kg(11lbs)	carton 20kg(44lbs)
2.6 (3/32)	350 (14)	✓	
3.2 (1/8)	350 (14)	✓	
4.0 (5/32)	400 (16)	✓	
5.0 (3/16)	400 (16)	✓	
6.0 (15/64)	450 (18)	✓	

## Typical Chemical Composition of All-Weld Metal (%)

C	Si	Mn	P	S	Mo
0.07	0.50	0.80	0.012	0.008	0.60

## Typical Mechanical Properties of All-Weld Metal

YS MPa(lbs/in <sup>2</sup> )	TS MPa(lbs/in <sup>2</sup> )	EL (%)	Heat Treatment
560 (81,000)	650 (94,000)	28.0	620°C(1148°F) X 1hr. S.R

## Typical Operating Procedures

Diameter mm (in)	2.6 (3/32)	3.2 (1/8)	4.0 (5/32)	5.0 (3/16)	6.0 (15/64)
Length mm (in)	350 (14)	350 (14)	400 (16)	400 (16)	450 (18)
F & HF	55-90A	90-130A	130-190A	190-240A	250-300A
V-up, OH	50-80A	80-120A	120-170A	-	-

SMAW

SAW

GMAW

GTAW

FCAW

Non-FERROUS

APPENDIX

# S-7018.A1

Type : Basic

## Conformances

AWS A5.5/ ASME SFA5.5 E7018-A1

JIS Z3223 E4918-1M3

EN 1599 - E Mo B 3 2

## Applications

- Low alloy steel (0.5% Mo)
- Pressure vessels

## Features

- Good mechanical properties
- Good bead appearance
- Iron powder type electrode (high efficiency)

## Welding Position



1G 2F 3G 4G  
(PA) (PB) (PF) (PE)

## Current

AC, DC ±

## Redrying Conditions

300~350°C (572~662°F) X

0.5~1hr

## Diameter / Packaging

Diameter mm (in)	Length mm (in)	Standard	
		packet 5kg(11lbs)	carton 20kg(44lbs)
2.6 (3/32)	350 (14)		✓
3.2 (1/8)	350 (14)		✓
4.0 (5/32)	400 (16)		✓
5.0 (3/16)	400 (16)		✓
6.0 (15/64)	450 (18)		✓

## Typical Chemical Composition of All-Weld Metal (%)

C	Si	Mn	P	S	Mo
0.07	0.77	0.88	0.018	0.010	0.52

## Typical Mechanical Properties of All-Weld Metal

YS MPa(lbs/in <sup>2</sup> )	TS MPa(lbs/in <sup>2</sup> )	EL (%)	Heat Treatment
477 (69,300)	617 (89,600)	32.8	620°C(1148°F) X 1hr. S.R

## Typical Operating Procedures

Diameter mm (in)	2.6 (3/32)	3.2 (1/8)	4.0 (5/32)	5.0 (3/16)	6.0 (15/64)
Length mm (in)	350 (14)	350 (14)	400 (16)	400 (16)	450 (18)
F & HF	55~90A	90~130A	130~190A	190~240A	250~300A
V-up, OH	50~80A	80~120A	120~170A	-	-



# S-8016.B1

Type : Basic

## Conformances

AWS A5.5/ ASME SFA5.5 E8016-B1

EN 1599 - E CrMo0.5 B 1 2

## Applications

- Low alloy steel (0.5%Cr-0.5%Mo)
- Pressure vessels
- Power plant

## Features

- Good crack resistance

## Welding Position



1G 2F 3G 4G  
(PA) (PB) (PF) (PE)

## Current

AC, DC ±

## Redrying Conditions

300~350°C (572~662°F) X

0.5~1hr

## Diameter / Packaging

Diameter mm (in)	Length mm (in)	Standard	
		packet 5kg(11lbs)	carton 20kg(44lbs)
2.6 (3/32)	350 (14)	✓	
3.2 (1/8)	350 (14)	✓	
4.0 (5/32)	400 (16)	✓	
5.0 (3/16)	400 (16)	✓	
6.0 (15/64)	450 (18)	✓	

## Typical Chemical Composition of All-Weld Metal (%)

C	Si	Mn	P	S	Cr	Mo
0.05	0.57	0.85	0.012	0.005	0.51	0.51

## Typical Mechanical Properties of All-Weld Metal

YS MPa(lbs/in <sup>2</sup> )	TS MPa(lbs/in <sup>2</sup> )	EL (%)	Heat Treatment
505 (73,300)	589 (85,500)	31.0	690°C(1274°F) X 1hr. S.R

## Typical Operating Procedures

Diameter mm (in)	2.6 (3/32)	3.2 (1/8)	4.0 (5/32)	5.0 (3/16)	6.0 (15/64)
Length mm (in)	350 (14)	350 (14)	400 (16)	400 (16)	450 (18)
F & HF	55-90A	90-130A	130-190A	190-240A	250-300A
V-up, OH	50-80A	80-120A	120-170A	-	-

SWAW

SAW

GMWAW

GTAW

FCAW

Non-FERROUS

APPENDIX

# S-8016.B2

Type : Basic

## Conformances

AWS A5.5/ ASME SFA5.5 E8016-B2  
 JIS Z3223 E5516-1CM  
 EN 1599 - E CrMo1 B 1 2  
 ABS A5.5 E8016-B2

## Applications

- Low alloy steel (1.25%Cr-0.5%Mo)
- Pressure vessels
- Power plant

## Features

- Maximum service temperature at 550°C (1022°F)
- Good mechanical properties
- Good creep resistance

## Welding Position



1G 2F 3G 4G  
 (PA) (PB) (PF) (PE)

## Current

AC, DC ±

## Redrying Conditions

300~350°C (572~662°F) X  
 0.5~1hr

## Diameter / Packaging

Diameter	Length	Standard	
		packet	carton
mm (in)	mm (in)	5kg(11lbs)	20kg(44lbs)
2.6 (3/32)	350 (14)		✓
3.2 (1/8)	350 (14)		✓
4.0 (5/32)	400 (16)		✓
5.0 (3/16)	400 (16)		✓
6.0 (15/64)	450 (18)		✓

## Typical Chemical Composition of All-Weld Metal (%)

C	Si	Mn	P	S	Cr	Mo
0.07	0.51	0.66	0.012	0.008	1.22	0.54

## Typical Mechanical Properties of All-Weld Metal

YS MPa(lbs/in <sup>2</sup> )	TS MPa(lbs/in <sup>2</sup> )	EL (%)	Heat Treatment
537 (78,000)	622 (90,300)	29.8	690°C(1274°F) X 1hr. S.R

## Typical Operating Procedures

Diameter mm (in)	2.6 (3/32)	3.2 (1/8)	4.0 (5/32)	5.0 (3/16)	6.0 (15/64)
Length mm (in)	350 (14)	350 (14)	400 (16)	400 (16)	450 (18)
F & HF	55~90A	90~130A	130~190A	190~240A	250~300A
V-up, OH	50~80A	80~120A	120~170A	-	-

# S-8018.B2

Type : Basic

## Conformances

AWS A5.5/ ASME SFA5.5 E8018-B2  
 JIS Z3223 E5518-1CM  
 EN 1599 - E CrMo1 B 3 2  
 ABS A5.5 E8018-B2

## Applications

- Low alloy steel (1.25%Cr-0.5%Mo)

## Features

- Iron powder and low hydrogen type electrode (high efficiency)
- Good mechanical properties
- Good creep resistance

## Welding Position



1G 2F 3G 4G  
 (PA) (PB) (PF) (PE)

## Current

AC, DC ±

## Redrying Conditions

300~350°C (572~662°F) X  
 0.5~1hr

## Diameter / Packaging

Diameter mm (in)	Length mm (in)	Standard	
		packet 5kg(11lbs)	carton 20kg(44lbs)
2.6 (3/32)	350 (14)		✓
3.2 (1/8)	350 (14)		✓
4.0 (5/32)	400 (16)		✓
5.0 (3/16)	400 (16)		✓
6.0 (15/64)	450 (18)		✓

## Typical Chemical Composition of All-Weld Metal (%)

C	Si	Mn	P	S	Cr	Mo
0.08	0.32	0.75	0.012	0.005	1.20	0.50

## Typical Mechanical Properties of All-Weld Metal

YS MPa(lbs/in <sup>2</sup> )	TS MPa(lbs/in <sup>2</sup> )	EL (%)	Heat Treatment
563 (82,000)	641 (93,000)	27.6	690°C(1274°F) X 1hr. S.R

## Typical Operating Procedures

Diameter mm (in)	2.6 (3/32)	3.2 (1/8)	4.0 (5/32)	5.0 (3/16)	6.0 (15/64)
Length mm (in)	350 (14)	350 (14)	400 (16)	400 (16)	450 (18)
F & HF	55-90A	90-130A	130-190A	190-240A	250-300A
V-up, OH	50-80A	80-120A	120-170A	-	-

SWAW

SAW

GMAW

GTAW

FCAW

Non-FERROUS

APPENDIX

# S-8018.B2R

Type : Basic

## Conformances

AWS A5.5/ ASME SFA5.5 E8018-B2

JIS Z3223 E5518-1CM

EN 1599 - ECrMo1 B 3 2 H5

## Applications

- Low alloy steel (1.25%Cr-0.5%Mo)

## Features

- Relevant elements P, Sn, As and Sb controlled (X-Factor  $\leq 15$ ppm)
- Low-Hydrogen electrode (HDM  $\leq 5$ ml/100g)
- Iron powder type electrode (high efficiency)
- Good impact value at low temperature

## Welding Position



1G 2F 3G 4G  
(PA) (PB) (PF) (PE)

## Current

AC, DC  $\pm$

## Redrying Conditions

300~350°C (572~662°F) X

0.5~1hr

## Diameter / Packaging

Diameter	Length	Standard		Vacuum				P.V.C	
		packet	carton	packet	carton	packet	carton	packet	carton
mm (in)	mm (in)	5kg(11lbs)	20kg(44lbs)	1.5kg(3.3lbs)	15kg(3.3lbs)	5kg(11lbs)	20kg(44lbs)	5kg(11lbs)	20kg(44lbs)
2.6 (3/32)	350 (14)			✓		✓		✓	
3.2 (1/8)	350 (14)			✓		✓		✓	
4.0 (5/32)	400 (16)			✓		✓		✓	
5.0 (3/16)	400 (16)			✓		✓		✓	

### Typical Chemical Composition of All-Weld Metal (%)

C	Si	Mn	P	S	Cr	Mo	Sn	As	Sb	X-factor(ppm)
0.069	0.57	0.82	0.007	0.010	1.32	0.58	0.0050	0.0020	0.0010	10.4

X-factor =  $(10P + 5Sb + 4Sn + As)/100 \leq 15$  (ppm)

### Typical Mechanical Properties of All-Weld Metal

YS MPa(lbs/in <sup>2</sup> )	TS MPa(lbs/in <sup>2</sup> )	EL (%)	Temp °C(°F)	CVN-Impact Value J (ft.lbs)	Heat Treatment
608 (88,200)	684 (99,200)	25.4	0 (32) -20 (-4)	144 (106) 62 (46)	690°C(1274°F) X 1hr. S.R
606 (87,900)	661 (95,900)	27.2	0 (32) -20 (-4)	143 (106) 91 (67)	690°C(1274°F) X 2hr. S.R

### Typical Operating Procedures

Diameter mm (in)	2.6 (3/32)	3.2 (1/8)	4.0 (5/32)	5.0 (3/16)
Length mm (in)	350 (14)	350 (14)	400 (16)	400 (16)
F & HF	55-90A	90-130A	130-190A	190-240A
V-up, OH	50-80A	80-120A	120-180A	-

# S-9016.B3

Type : Basic

## Conformances

AWS A5.5/ ASME SFA5.5 E9016-B3

JIS Z3223 E6216-2C1M

EN 1599 - ECrMo2 B 1 2

## Applications

- Low alloy steel (2.25%Cr-1%Mo)
- Pressure vessels
- Power plant

## Features

- Maximum service temperature at 600°C (1112°F)
- Good mechanical properties
- Good creep resistance

## Welding Position



1G 2F 3G 4G  
(PA) (PB) (PF) (PE)

## Current

AC, DC ±

## Redrying Conditions

300~350°C (572~662°F) X

0.5~1hr

## Diameter / Packaging

Diameter	Length	Standard	
		packet	carton
mm (in)	mm (in)	5kg(11lbs)	20kg(44lbs)
2.6 (3/32)	350 (14)		✓
3.2 (1/8)	350 (14)		✓
4.0 (5/32)	400 (16)		✓
5.0 (3/16)	400 (16)		✓
6.0 (15/64)	450 (18)		✓

## Typical Chemical Composition of All-Weld Metal (%)

C	Si	Mn	P	S	Cr	Mo
0.07	0.57	0.82	0.022	0.012	2.32	1.07

## Typical Mechanical Properties of All-Weld Metal

YS MPa(lbs/in <sup>2</sup> )	TS MPa(lbs/in <sup>2</sup> )	EL (%)	Heat Treatment
554 (80,500)	663 (96,300)	25.6	690°C(1274°F) X 1hr. S.R

## Typical Operating Procedures

Diameter mm (in)	2.6 (3/32)	3.2 (1/8)	4.0 (5/32)	5.0 (3/16)	6.0 (15/64)
Length mm (in)	350 (14)	350 (14)	400 (16)	400 (16)	450 (18)
F & HF	55~90A	90~130A	130~190A	190~240A	250~300A
V-up, OH	50~80A	80~120A	120~170A	-	-

# S-9018.B3

Type : Basic

## Conformances

AWS	A5.5/ ASME SFA5.5 E9018-B3
JIS	Z3223 E6218-2C1M
EN	1599 - ECrMo2 B 3 2
KR	AWS A5.5 E9018-B3
ABS	AWS A5.5 E9018-B3
LR	AWS A5.5 E9018-B3
DNV	H10

## Applications

- Low alloy steel (2.25%Cr-1%Mo)

## Features

- Maximum service temperature at 600°C (1112°F)
- Good mechanical properties
- Good creep resistance
- Iron powder low hydrogen type electrode (high efficiency)

## Welding Position



1G 2F 3G 4G  
(PA) (PB) (PF) (PE)

## Current

AC, DC ±

## Redrying Conditions

300~350°C (572~662°F) X  
0.5~1hr

## Diameter / Packaging

Diameter mm (in)	Length mm (in)	Standard	
		packet 5kg(11lbs)	carton 20kg(44lbs)
2.6 (3/32)	350 (14)		✓
3.2 (1/8)	350 (14)		✓
4.0 (5/32)	400 (16)		✓
5.0 (3/16)	400 (16)		✓
6.0 (15/64)	450 (18)		✓

## Typical Chemical Composition of All-Weld Metal (%)

C	Si	Mn	P	S	Cr	Mo
0.08	0.64	0.83	0.020	0.011	2.11	1.0

## Typical Mechanical Properties of All-Weld Metal

YS MPa(lbs/in <sup>2</sup> )	TS MPa(lbs/in <sup>2</sup> )	EL (%)	Heat Treatment
570 (82,800)	677 (98,300)	24.2	690°C(1274°F) X 1hr. S.R

## Typical Operating Procedures

Diameter mm (in)	2.6 (3/32)	3.2 (1/8)	4.0 (5/32)	5.0 (3/16)	6.0 (15/64)
Length mm (in)	350 (14)	350 (14)	400 (16)	400 (16)	450 (18)
F & HF	55-90A	90-130A	130-190A	190-240A	250-300A
V-up, OH	50-80A	80-120A	120-170A	-	-

SWAW

SAW

GMWAW

GTAW

FCAW

Non-FERROUS

APPENDIX

# S-9018.B3R

Type : Basic

## Conformances

AWS A5.5/ ASME SFA5.5 E9018-B3

JIS Z3223 E6218-2C1M

EN 1599 - ECrMo2 B 3 2 H5

## Applications

- Low alloy steel (2.25%Cr-1%Mo)

## Features

- Relevant elements P, Sn, As and Sb controlled (X-Factor  $\leq 15$ ppm)
- Low-Hydrogen electrode (HDM  $\leq 5$ ml/100g)
- Iron powder type electrode (high efficiency)
- Good impact value at low temperature

## Welding Position



1G 2F 3G 4G  
(PA) (PB) (PF) (PE)

## Current

AC, DC  $\pm$

## Redrying Conditions

300~350°C (572~662°F) X

0.5~1hr

## Diameter / Packaging

Diameter	Length	Standard		Vacuum				P.V.C	
		packet	carton	packet	carton	packet	carton	packet	carton
mm (in)	mm (in)	5kg(11lbs)	20kg(44lbs)	1.5kg(3.3lbs)	15kg(3.3lbs)	5kg(11lbs)	20kg(44lbs)	5kg(11lbs)	20kg(44lbs)
2.6 (3/32)	350 (14)			✓		✓		✓	
3.2 (1/8)	350 (14)			✓		✓		✓	
4.0 (5/32)	400 (16)			✓		✓		✓	
5.0 (3/16)	400 (16)			✓		✓		✓	



### Typical Chemical Composition of All-Weld Metal (%)

C	Si	Mn	P	S	Cr	Mo	Sn	As	Sb	X-factor(ppm)
0.072	0.62	0.79	0.009	0.010	2.22	0.97	0.0060	0.0020	0.0070	13.1

$$X\text{-factor} = (10P + 5Sb + 4Sn + As)/100 \leq 15 \text{ (ppm)}$$

### Typical Mechanical Properties of All-Weld Metal

YS MPa(lbs/in <sup>2</sup> )	TS MPa(lbs/in <sup>2</sup> )	EL (%)	Temp °C(°F)	CVN-Impact Value J (ft.lbs)	Heat Treatment
632 (91,700)	721 (104,600)	23.8	0 (32) -20 (-4)	121 (89) 81 (60)	690°C(1274°F) X 1hr. S.R
606 (87,900)	703 (102,000)	25.2	0 (32) -20 (-4)	132 (97) 105 (77)	690°C(1274°F) X 2hr. S.R

### Typical Operating Procedures

Diameter mm (in)	2.6 (3/32)	3.2 (1/8)	4.0 (5/32)	5.0 (3/16)
Length mm (in)	350 (14)	350 (14)	400 (16)	400 (16)
F & HF	55-90A	90-130A	130-190A	190-240A
V-up, OH	50-80A	80-120A	120-180A	-

# S-8016.B5

Type : Basic

## Conformances

AWS A5.5/ ASME SFA5.5 E8016-B5

EN 1599 - ECrMo5 B 1 2

## Applications

- Low alloy steel (0.5%Cr-1%Mo)

## Features

- Good mechanical properties

## Welding Position



1G 2F 3G 4G  
(PA) (PB) (PF) (PE)

## Current

AC, DC ±

## Redrying Conditions

300~350°C (572~662°F) X

0.5~1hr

## Diameter / Packaging

Diameter mm (in)	Length mm (in)	Standard	
		packet 5kg(11lbs)	carton 20kg(44lbs)
2.6 (3/32)	350 (14)		✓
3.2 (1/8)	350 (14)		✓
4.0 (5/32)	400 (16)		✓
5.0 (3/16)	400 (16)		✓
6.0 (15/64)	450 (18)		✓

## Typical Chemical Composition of All-Weld Metal (%)

C	Si	Mn	P	S	Cr	Mo
0.10	0.48	0.59	0.019	0.009	0.51	1.0

## Typical Mechanical Properties of All-Weld Metal

YS MPa(lbs/in <sup>2</sup> )	TS MPa(lbs/in <sup>2</sup> )	EL (%)	Heat Treatment
555 (80,600)	663 (96,300)	27.8	690°C(1274°F) X 1hr. S.R

## Typical Operating Procedures

Diameter mm (in)	2.6 (3/32)	3.2 (1/8)	4.0 (5/32)	5.0 (3/16)	6.0 (15/64)
Length mm (in)	350 (14)	350 (14)	400 (16)	400 (16)	450 (18)
F & HF	55~90A	90~130A	130~190A	190~240A	250~300A
V-up, OH	50~80A	80~120A	120~170A	-	-

# S-8016.B6

Type : Basic

## Conformances

AWS A5.5/ ASME SFA5.5 E8016-B6

JIS Z3223 DT2516

EN 1599 - ECrMo5 B 1 2

## Applications

- Low alloy steel (5%Cr-0.5%Mo)

## Features

- Low hydrogen type electrode
- Good creep resistance at high temperature
- Good crack resistance

## Welding Position



1G 2F 3G 4G  
(PA) (PB) (PF) (PE)

## Current

AC, DC ±

## Redrying Conditions

300~350°C (572~662°F) X

0.5~1hr

## Diameter / Packaging

Diameter	Length	Standard		Vacuum				P.V.C	
		packet	carton	packet	carton	packet	carton	packet	carton
mm (in)	mm (in)	5kg(11lbs)	20kg(44lbs)	1.5kg(3.3lbs)	15kg(3.3lbs)	5kg(11lbs)	20kg(44lbs)	5kg(11lbs)	20kg(44lbs)
2.6 (3/32)	350 (14)	✓		✓		✓		✓	
3.2 (1/8)	350 (14)	✓		✓		✓		✓	
4.0 (5/32)	350 (14)	✓		✓		✓		✓	
	400 (16)	✓		✓		✓		✓	
5.0 (3/16)	400 (16)	✓		✓		✓		✓	

SMW

SAW

GMW

GTAW

FCW

Non-FERROUS

APPENDIX

### Typical Chemical Composition of All-Weld Metal (%)

C	Si	Mn	P	S	Cr	Ni	Mo
0.06	0.57	0.85	0.005	0.004	5.45	0.02	0.51

### Typical Mechanical Properties of All-Weld Metal

YS MPa(lbs/in <sup>2</sup> )	TS MPa(lbs/in <sup>2</sup> )	EL (%)	Temp °C(°F)	CVN-Impact Value J (ft-lbs)	Heat Treatment
570 (82,700)	670 (97,200)	22	0 (32)	136 (100)	740°C(1364°F) X 1hr. S.R

### Typical Operating Procedures

Diameter mm (in)	2.6 (3/32)	3.2 (1/8)	4.0 (5/32)	5.0 (3/16)
Length mm (in)	350 (14)	350 (14)	400 (16)	400 (16)
F	50-90	80-120	120-160	160-210
V-up, OH	50-80	70-110	90-130	-

# S-9015.B9

Type : Basic

## Conformances

AWS A5.5/ ASME SFA5.5 E9015-B9

JIS Z3223 E6215-9C1MV

EN 1599 - ECrMo91 B 4 2 H5

## Applications

- Heat resistant steel (9%Cr-1%Mo)

## Features

- Good creep resistance at high temperature
- Maximum service temperature at 650°C (1202°F)
- Low-Hydrogen electrode (HDM ≤5ml/100g)
- Good performance with DCEP

## Welding Position



1G 2F 3G 4G  
(PA) (PB) (PF) (PE)

## Current

DC ±

## Redrying Conditions

300~350°C (572~662°F) X

0.5~1hr

## Diameter / Packaging

Diameter	Length	Standard		Vacuum				P.V.C	
		packet	carton	packet	carton	packet	carton	packet	carton
mm (in)	mm (in)	5kg(11lbs)	20kg(44lbs)	1.5kg(3.3lbs)	15kg(3.3lbs)	5kg(11lbs)	20kg(44lbs)	5kg(11lbs)	20kg(44lbs)
2.6 (3/32)	350 (14)	√		√		√		√	
3.2 (1/8)	350 (14)	√		√		√		√	
4.0 (5/32)	350 (14)	√		√		√		√	
	400 (16)	√		√		√		√	
5.0 (3/16)	400 (16)	√		√		√		√	

SMW

SAW

GMW

GTAW

FCW

Non-FERROUS

APPENDIX

### Typical Chemical Composition of All-Weld Metal (%)

C	Si	Mn	P	S	Cr	Ni	Mo	V	Nb	N
0.10	0.24	0.90	0.008	0.006	9.25	0.50	0.99	0.25	0.023	0.043

### Typical Mechanical Properties of All-Weld Metal

YS MPa(lbs/in <sup>2</sup> )	TS MPa(lbs/in <sup>2</sup> )	EL (%)	Temp °C(°F)	CVN-Impact Value J (ft.-lbs)	Heat Treatment
604 (87,600)	746 (108,200)	22.2	20 (68)	71 (52)	760°C(1400°F) X 2hr. S.R
684 (99,200)	733 (106,300)	25.2	20 (68)	85 (63)	760°C(1400°F) X 4hr. S.R

### Typical Operating Procedures

Diameter mm (in)	2.6 (3/32)	3.2 (1/8)	4.0 (5/32)		5.0 (3/16)
Length mm (in)	350 (14)	350 (14)	350 (14)	400 (16)	400 (16)
F & HF	55~90A	90~130A	130~190A	130~190A	190~240A
V-up, OH	50~80A	80~120A	120~180A	120~180A	-

# S-9016.B9

Type : Basic

## Conformances

AWS A5.5/ ASME SFA5.5 E9016-B9 H4

JIS Z3223 E6216-9C1MV

EN 1599 - ECrMo91 B 3 2 H5

## Applications

- Heat resistant steel (9%Cr-1%Mo)

## Features

- Good creep resistance at high temperature
- Maximum service temperature at 650°C (1202°F)
- Low-Hydrogen electrode (HDM ≤5ml/100g)

## Welding Position



1G 2F 3G 4G  
(PA) (PB) (PF) (PE)

## Current

AC, DC ±

## Redrying Conditions

300~350°C (572~662°F) X

0.5~1hr

## Diameter / Packaging

Diameter	Length	Standard		Vacuum				P.V.C	
		packet	carton	packet	carton	packet	carton	packet	carton
mm (in)	mm (in)	5kg(11lbs)	20kg(44lbs)	1.5kg(3.3lbs)	15kg(3.3lbs)	5kg(11lbs)	20kg(44lbs)	5kg(11lbs)	20kg(44lbs)
2.6 (3/32)	350 (14)	√		√		√		√	
3.2 (1/8)	350 (14)	√		√		√		√	
4.0 (5/32)	350 (14)	√		√		√		√	
	400 (16)	√		√		√		√	
5.0 (3/16)	400 (16)	√		√		√		√	

SWAW

SAW

GMWAW

GTAW

FCAW

Non-FERROUS

APPENDIX

### Typical Chemical Composition of All-Weld Metal (%)

C	Si	Mn	P	S	Cr	Ni	Mo	V	Nb	N
0.10	0.24	1.00	0.009	0.006	9.07	0.45	1.00	0.22	0.036	0.035

### Typical Mechanical Properties of All-Weld Metal

YS MPa(lbs/in <sup>2</sup> )	TS MPa(lbs/in <sup>2</sup> )	EL (%)	Temp °C(°F)	CVN-Impact Value J (ft-lbs)	Heat Treatment
660 (95,700)	762 (110,500)	24.8	20 (68)	71 (52)	760°C(1400°F) X 2hr. S.R

### Typical Operating Procedures

Diameter mm (in)	2.6 (3/32)	3.2 (1/8)	4.0 (5/32)		5.0 (3/16)
Length mm (in)	350 (14)	350 (14)	350 (14)	400 (16)	400 (16)
F & HF	80-110A	110-150A	150-200A	150-200A	190-240A
V-up, OH	70-100A	100-140A	140-200A	140-200A	-



# S-9015(6).B92

Type : Basic

## Conformances

AWS A5.5/ ASME SFA5.5 E9015(6)-G  
(E9015(6)-B9 mod.)

## Applications

- Heat resistant steel (9%Cr-1%Mo-1.5%W)

## Features

- Designed to weld equivalent 'type 92' 9CrMoW steels
- Low-Hydrogen electrode (HDM  $\leq$ 5ml/100g)
- Maximum service temperature at 650°C (1202°F)
- Good creep resistance at high temperature
- S-9015.B92 (DC $\pm$  only)

## Welding Position

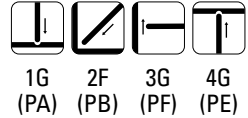

## Current

AC, DC  $\pm$

## Redrying Conditions

300~350°C (572~662°F) X  
0.5~1hr

## Diameter / Packaging

Diameter	Length	Standard		Vacuum				P.V.C	
		packet	carton	packet	carton	packet	carton	packet	carton
2.6 (3/32)	350 (14)		√		√		√		√
3.2 (1/8)	350 (14)		√		√		√		√
4.0 (5/32)	350 (14)		√		√		√		√
	400 (16)		√		√		√		√
5.0 (3/16)	400 (16)		√		√		√		√

SMW

SAW

GMW

GTAW

FCW

Non-FERROUS

APPENDIX

### Typical Chemical Composition of All-Weld Metal (%)

C	Si	Mn	P	S	Cr	Ni	Mo	V	Nb	N	W
0.08	0.24	0.60	0.006	0.004	9.18	0.45	0.40	0.25	0.050	0.045	1.45

### Typical Mechanical Properties of All-Weld Metal

YS MPa(lbs/in <sup>2</sup> )	TS MPa(lbs/in <sup>2</sup> )	EL (%)	Temp °C(°F)	CVN-Impact Value J (ft-lbs)	Heat Treatment
670 (97,200)	779 (113,000)	20.2	20 (68)	23 (17)	760°C(1400°F) X 2hr. S.R

### Typical Operating Procedures

Diameter mm (in)	2.6 (3/32)	3.2 (1/8)	4.0 (5/32)		5.0 (3/16)
Length mm (in)	350 (14)	350 (14)	350 (14)	400 (16)	400 (16)
F & HF	55-90A	90-130A	130-190A	130-190A	190-240A
V-up, OH	50-80A	80-120A	120-180A	120-180A	-

# S-240A.R

Type : Rutile

## Conformances

JIS Z3251 DF2A-250-R

## Applications

- Hardfacing of rollers, gears, crane wheels and abrasive parts

## Features

- Light abrasive resistance, impact resistance
- Good cutting properties
- Stable arc
- Easy to remove slag
- Low spatter
- Good bead appearance

## Welding Position



1G 2F 3G  
(PA) (PB) (PF)

## Current

AC or DC ±

## Redrying Conditions

100°C (212°F) X 1 hr

## Diameter / Packaging

Diameter mm (in)	Length mm (in)	Standard	
		packet 5kg(11lbs)	carton 20kg(44lbs)
2.6 (3/32)	350 (14)	✓	
3.2 (1/8)	350 (14)	✓	
4.0 (5/32)	400 (16)	✓	
5.0 (3/16)	400 (16)	✓	
6.0 (15/64)	450 (18)	✓	

## Typical Chemical Composition of All-Weld Metal (%)

C	Si	Mn	P	S	Cr
0.10	0.37	0.49	0.017	0.009	0.89

## Typical Mechanical Properties of All-Weld Metal

Preheat & Interpass Temp.°C(°F)	Postheat	Heat Treatment	Hardness (HB)
150 (302)	-	-	240
-	-	650°C(1202°F) Tempering	200
-	-	900°C(1652°F), O.Q	330

## Typical Operating Procedures

Diameter mm (in)	2.6 (3/32)	3.2 (1/8)	4.0 (5/32)	5.0 (3/16)	6.0 (15/64)
Length mm (in)	350 (14)	350 (14)	400 (16)	400 (16)	450 (18)
F & HF	50-85A	80-130A	130-180A	180-240A	210-280A
V-up, OH	45-70A	70-120A	120-160A	-	-

SWAW

SAW

GMAW

GTAW

FCAW

Non-FERROUS

APPENDIX

# S-350A.R

Type : Rutile

## Conformances

JIS Z3251 DF2A-350-R

## Applications

- Hardfacing of rollers, gears, crane wheels and abrasive parts

## Features

- Medium abrasive resistance, impact resistance
- Machining / Quenching possible
- Easy to remove slag
- Good bead appearance

## Welding Position



1G 2F 3G  
(PA) (PB) (PF)

## Current

AC or DC ±

## Redrying Conditions

100°C (212°F) X 1hr

## Diameter / Packaging

Diameter	Length	Standard	
		packet	carton
2.6 (3/32)	350 (14)	5kg(11lbs)	20kg(44lbs)
3.2 (1/8)	350 (14)	✓	✓
4.0 (5/32)	400 (16)	✓	✓
5.0 (3/16)	400 (16)	✓	✓
6.0 (15/64)	450 (18)	✓	✓

## Typical Chemical Composition of All-Weld Metal (%)

C	Si	Mn	P	S	Cr
0.10	0.50	1.00	0.010	0.007	2.40

## Typical Mechanical Properties of All-Weld Metal

Preheat & Interpass Temp. °C(°F)	Postheat	Heat Treatment	Hardness (HB)
150 (302)	-	-	370
-	-	650°C(1202°F) Tempering	280
-	-	850°C(1562°F), O.Q	430

## Typical Operating Procedures

Diameter mm (in)	2.6 (3/32)	3.2 (1/8)	4.0 (5/32)	5.0 (3/16)	6.0 (15/64)
Length mm (in)	350 (14)	350 (14)	400 (16)	400 (16)	450 (18)
F & HF	55~90A	90~140A	140~190A	190~240A	220~300A
V-up, OH	50~80A	80~130A	110~160A	-	-

# S-260A.B

Type : Basic

## Conformances

JIS Z3251 DF2A-300-B

## Applications

- Hardfacing of rollers, gears, crane wheels and abrasive parts

## Features

- Light abrasive resistance, impact resistance
- Good cutting properties
- Easy to remove slag
- Low spatter
- Good bead appearance

## Welding Position



1G 2F 3G  
(PA) (PB) (PF)

## Current

AC or DC ±

## Redrying Conditions

350°C (662°F) X 1hr

## Diameter / Packaging

Diameter mm (in)	Length mm (in)	Standard	
		packet 5kg(11lbs)	carton 20kg(44lbs)
2.6 (3/32)	350 (14)	✓	
3.2 (1/8)	350 (14)	✓	
4.0 (5/32)	400 (16)	✓	
5.0 (3/16)	400 (16)	✓	
6.0 (15/64)	450 (18)	✓	

## Typical Chemical Composition of All-Weld Metal (%)

C	Si	Mn	P	S	Cr
0.15	0.68	2.15	0.015	0.007	0.05

## Typical Mechanical Properties of All-Weld Metal

Preheat & Interpass Temp.°C(°F)	Postheat	Heat Treatment	Hardness (HB)
150 (302)	-	-	260
-	-	650°C(1202°F) Tempering	240
-	-	900°C(1652°F), O.Q	380

## Typical Operating Procedures

Diameter mm (in)	2.6 (3/32)	3.2 (1/8)	4.0 (5/32)	5.0 (3/16)	6.0 (15/64)
Length mm (in)	350 (14)	350 (14)	400 (16)	400 (16)	450 (18)
F & HF	55-90A	90-140A	140-190A	190-240A	220-300A
V-up, OH	50-80A	80-130A	110-160A	-	-

SWAW

SAW

GMWAW

GTAW

FCAW

Non-FERROUS

APPENDIX

# S-350B.B

Type : Basic

## Conformances

JIS Z3251 DF2A-400-B

## Applications

- Hardfacing of rollers, gears, crane wheels and abrasive parts

## Features

- Medium abrasive resistance, impact resistance
- Machining possible
- Low spatter
- Good bead appearance
- Hardness increased by quenching after machining

## Welding Position



1G 2F 3G  
(PA) (PB) (PF)

## Current

AC or DC ±

## Redrying Conditions

350°C (662°F) X 1hr

## Diameter / Packaging

Diameter	Length	Standard	
		packet	carton
mm (in)	mm (in)	5kg(11lbs)	20kg(44lbs)
2.6 (3/32)	350 (14)	√	
3.2 (1/8)	350 (14)	√	
4.0 (5/32)	400 (16)	√	
5.0 (3/16)	400 (16)	√	
6.0 (15/64)	450 (18)	√	

## Typical Chemical Composition of All-Weld Metal (%)

C	Si	Mn	P	S	Cr
0.26	0.82	1.44	0.015	0.009	1.88

## Typical Mechanical Properties of All-Weld Metal

Preheat & Interpass Temp. °C(°F)	Postheat	Heat Treatment	Hardness (HB)
150 (302)	-	-	390
-	-	650°C(1202°F) Tempering	280
-	-	850°C(1562°F), O.Q	470

## Typical Operating Procedures

Diameter mm (in)	2.6 (3/32)	3.2 (1/8)	4.0 (5/32)	5.0 (3/16)	6.0 (15/64)
Length mm (in)	350 (14)	350 (14)	400 (16)	400 (16)	450 (18)
F & HF	55~90A	90~140A	140~190A	190~240A	220~300A
V-up, OH	50~80A	80~130A	110~160A	-	-

# S-450B.B

Type : Basic

## Conformances

JIS Z3251 DF2A-450-B

## Applications

- Hardfacing of rollers, gears, crane wheels and abrasive parts

## Features

- Mixed metal structure of austenite and martensite
- Under-lay with low hydrogen type carbon steel electrode
- Preheat at more than 150°C(302°F)

## Welding Position



1G 2F 3G  
(PA) (PB) (PF)

## Current

AC or DC ±

## Redrying Conditions

350°C (662°F) X 1hr

## Diameter / Packaging

Diameter mm (in)	Length mm (in)	Standard	
		packet 5kg(11lbs)	carton 20kg(44lbs)
2.6 (3/32)	350 (14)	✓	
3.2 (1/8)	350 (14)	✓	
4.0 (5/32)	400 (16)	✓	
5.0 (3/16)	400 (16)	✓	
6.0 (15/64)	450 (18)	✓	

## Typical Chemical Composition of All-Weld Metal (%)

C	Si	Mn	P	S	Cr	Mo
0.30	1.06	0.56	0.019	0.01	1.64	0.63

## Typical Mechanical Properties of All-Weld Metal

Preheat & Interpass Temp.°C(°F)	Postheat	Heat Treatment	Hardness (HB)
150 (302)	-	-	420
300 (572)	-	-	380
-	-	650°C(1202°F) 6hr.F.C	410
-	-	625°C(1157°F) 6hr.F.C	330

## Typical Operating Procedures

Diameter mm (in)	2.6 (3/32)	3.2 (1/8)	4.0 (5/32)	5.0 (3/16)	6.0 (15/64)
Length mm (in)	350 (14)	350 (14)	400 (16)	400 (16)	450 (18)
F & HF	55-90A	90-140A	140-190A	190-240A	220-300A
V-up, OH	50-80A	80-130A	110-160A	-	-

SWAW

SAW

GMWAW

GTAW

FCAW

Non-FERROUS

APPENDIX

# S-500B.B

Type : Basic

## Conformances

JIS Z3251 DF2B-500-B

## Applications

- Hardfacing of rollers, gears, crane wheels and abrasive parts

## Features

- Under-lay with low hydrogen type carbon steel electrode
- Preheat at more than 150°C(302°F)
- Machining difficult

## Welding Position



1G 2F  
(PA) (PB)

## Current

AC or DC ±

## Redrying Conditions

350°C (662°F) X 1hr

## Diameter / Packaging

Diameter mm (in)	Length mm (in)	Standard	
		packet 5kg(11lbs)	carton 20kg(44lbs)
2.6 (3/32)	350 (14)	✓	
3.2 (1/8)	350 (14)	✓	
4.0 (5/32)	400 (16)	✓	
5.0 (3/16)	400 (16)	✓	
6.0 (15/64)	450 (18)	✓	

## Typical Chemical Composition of All-Weld Metal (%)

C	Si	Mn	P	S	Cr	Mo
0.41	0.75	1.73	0.018	0.007	1.60	0.86

## Typical Mechanical Properties of All-Weld Metal

Preheat & Interpass Temp.°C(°F)	Postheat	Heat Treatment	Hardness (HB)
150 (302)	-	-	520
300 (572)	-	-	480

## Typical Operating Procedures

Diameter mm (in)	2.6 (3/32)	3.2 (1/8)	4.0 (5/32)	5.0 (3/16)	6.0 (15/64)
Length mm (in)	350 (14)	350 (14)	400 (16)	400 (16)	450 (18)
F & HF	55-90A	90-140A	140-190A	190-240A	220-300A



# S-600B.B

Type : Basic

## Conformances

JIS Z3251 DF2B-600-B

## Applications

- Hardfacing of rollers, gears, crane wheels and abrasive parts

## Features

- Under-lay with low hydrogen type carbon steel electrode
- Preheat at more than 150°C(302°F)
- Suitable for soil abrasion
- Martensite structure (All-weld metal)

## Welding Position



1G 2F  
(PA) (PB)

## Current

AC or DC ±

## Redrying Conditions

350°C (662°F) X 1hr

## Diameter / Packaging

Diameter mm (in)	Length mm (in)	Standard	
		packet 5kg(11lbs)	carton 20kg(44lbs)
2.6 (3/32)	350 (14)	✓	
3.2 (1/8)	350 (14)	✓	
4.0 (5/32)	400 (16)	✓	
5.0 (3/16)	400 (16)	✓	
6.0 (15/64)	450 (18)	✓	

## Typical Chemical Composition of All-Weld Metal (%)

C	Si	Mn	P	S	Cr	Mo
0.52	1.10	1.61	0.022	0.009	3.90	1.34

## Typical Mechanical Properties of All-Weld Metal

Preheat & Interpass Temp.°C(°F)	Postheat	Heat Treatment	Hardness (HB)
150 (302)	-	-	540
300 (572)	-	-	500
600 (1112)	-	-	450

## Typical Operating Procedures

Diameter mm (in)	2.6 (3/32)	3.2 (1/8)	4.0 (5/32)	5.0 (3/16)	6.0 (15/64)
Length mm (in)	350 (14)	350 (14)	400 (16)	400 (16)	450 (18)
F & HF	55-90A	90-140A	140-190A	190-240A	220-300A

SMW

SAW

GMW

GTAW

FCW

Non-FERROUS

APPENDIX

# S-700B.B

Type : Basic

## Conformances

JIS Z3251 DF3C-600-B

## Applications

- Hardfacing of rollers, gears, crane wheels and abrasive parts

## Features

- Preheat at more than 150°C(302°F)
- Postheat at about 600°C(1112°F), if possible
- Martensite structure (All-weld metal)
- Machining impossible (As welded)
- Mostly suitable for soil abrasion

## Welding Position



1G 2F  
(PA) (PB)

## Current

AC or DC ±

## Redrying Conditions

350°C (662°F) X 1hr

## Diameter / Packaging

Diameter mm (in)	Length mm (in)	Standard	
		packet 5kg(11lbs)	carton 20kg(44lbs)
2.6 (3/32)	350 (14)	✓	
3.2 (1/8)	350 (14)	✓	
4.0 (5/32)	400 (16)	✓	
5.0 (3/16)	400 (16)	✓	
6.0 (15/64)	450 (18)	✓	

## Typical Chemical Composition of All-Weld Metal (%)

C	Si	Mn	P	S	Cr	Mo
0.56	1.26	1.67	0.029	0.011	4.06	1.84

## Typical Mechanical Properties of All-Weld Metal

Preheat & Interpass Temp.°C(°F)	Postheat	Heat Treatment	Hardness (HB)
150 (302)	-	-	610
300 (572)	-	-	580

## Typical Operating Procedures

Diameter mm (in)	2.6 (3/32)	3.2 (1/8)	4.0 (5/32)	5.0 (3/16)	6.0 (15/64)
Length mm (in)	350 (14)	350 (14)	400 (16)	400 (16)	450 (18)
F & HF	55-90A	90-140A	140-190A	190-240A	220-300A

# S-711

Type : Basic

## Conformances

JIS Z3251 DFCrA-600-BR

## Applications

- Mills to crush clinker in cement industry
- Screws in oil industry

## Features

- Good wear resistance
- Austenite structure containing Cr-Carbide
- Machining impossible (As welded)
- Preheat at more than 150°C(302°F)

## Welding Position



1G 2F  
(PA) (PB)

## Current

AC or DC ±

## Redrying Conditions

350°C (662°F) X 1hr

## Diameter / Packaging

Diameter mm (in)	Length mm (in)	Standard	
		packet 5kg(11lbs)	carton 20kg(44lbs)
2.6 (3/32)	350 (14)		
3.2 (1/8)	350 (14)	✓	
4.0 (5/32)	400 (16)	✓	
5.0 (3/16)	400 (16)	✓	
6.0 (15/64)	450 (18)		

## Typical Chemical Composition of All-Weld Metal (%)

C	Si	Mn	P	S	Cr
3.47	0.90	1.11	0.018	0.014	33.87

## Typical Mechanical Properties of All-Weld Metal

Preheat & Interpass Temp. °C(°F)	Postheat	Heat Treatment	Hardness (HB)
≥300 (572)	-	-	610

## Typical Operating Procedures

Diameter mm (in)	3.2 (1/8)	4.0 (5/32)	5.0 (3/16)
Length mm (in)	350 (14)	400 (16)	400 (16)
F & HF	90~140A	140~190A	190~240A

SMW

SAW

GMW

GTAW

FCAW

Non-FERROUS

APPENDIX

# S-13MN.B

Type : Basic

## Conformances

JIS Z3251 DFMA-250-B

## Applications

- Light impact abrasion, crusher hammers, jaws, rolls and buckets

## Features

- High impact resistance
- Good resistance to abrasion
- Mostly suitable for soil abrasion
- Cutting properties impossible
- Easy to remove slag

## Welding Position



1G 2F  
(PA) (PB)

## Current

AC or DC ±

## Redrying Conditions

350°C (662°F) X 1hr

## Diameter / Packaging

Diameter mm (in)	Length mm (in)	Standard	
		packet 5kg(11lbs)	carton 20kg(44lbs)
2.6 (3/32)	350 (14)		
3.2 (1/8)	350 (14)	✓	
4.0 (5/32)	400 (16)	✓	
5.0 (3/16)	400 (16)	✓	
6.0 (15/64)	450 (18)	✓	

## Typical Chemical Composition of All-Weld Metal (%)

C	Si	Mn	P	S	Cr	Mo
0.38	0.06	14.5	0.030	0.003	1.16	1.57

## Typical Mechanical Properties of All-Weld Metal

Preheat & Interpass Temp. °C(°F)	Postheat	Heat Treatment	Hardness (HB)
RT	-	-	220
	-	After work hardening	480

## Typical Operating Procedures

Diameter mm (in)	3.2 (1/8)	4.0 (5/32)	5.0 (3/16)	6.0 (15/64)
Length mm (in)	350 (14)	400 (16)	400 (16)	450 (18)
F & HF	90~140A	140~190A	190~240A	220~300A

# S-308.16N

Type : Rutile

## Conformances

AWS A5.4/ ASME SFA5.4 E308-16  
 JIS Z3221 ES308-16  
 EN ISO 3581-A-E 19 9 R  
 KR RD308  
 ABS AWS A5.4 E308-16  
 DNV 308

## Applications

- Stainless steel (18%Cr-8%Ni)

## Features

- Good resistance to corrosion and oxidizing environments
- Easy to remove slag
- Low spatter
- Good bead appearance

## Welding Position



1G 2F 3G 4G  
 (PA) (PB) (PF) (PE)

## Current

AC or DC ±

## Redrying Conditions

350°C (662°F) X 1hr

## Diameter / Packaging

Diameter	Length	P.V.C	
		packet	carton
mm (in)	mm (in)	2.5kg(5.5lbs)	10kg(22lbs)
2.6 (3/32)	350 (14)	✓	
3.2 (1/8)	350 (14)	✓	
4.0 (5/32)	400 (16)	✓	
5.0 (3/16)	400 (16)	✓	
6.0 (15/64)	450 (18)	✓	

## Typical Chemical Composition of All-Weld Metal (%)

C	Si	Mn	P	S	Cr	Ni
0.03	0.66	0.87	0.026	0.014	19.2	10.2

## Typical Mechanical Properties of All-Weld Metal

TS MPa(lbs/in <sup>2</sup> )	EL (%)
562 (81,600)	47.8

## Typical Operating Procedures

Diameter mm (in)	2.0 (5/64)	2.6 (3/32)	3.2 (1/8)	4.0 (5/32)	5.0 (3/16)
Length mm (in)	300 (12)	300 (12)	350 (14)	350 (14)	350 (14)
F & HF	25-55A	50-85A	70-115A	95-145A	135-180A
V-up, OH	20-50A	45-80A	65-110A	85-135A	-

SMW

SAW

GMW

GTAW

FCW

Non-FERROUS

APPENDIX

# S-308H.16

Type : Rutile

## Conformances

AWS A5.4/ ASME SFA5.4 E308H-16

## Applications

- Stainless steel (ASTM 304H, 304)

## Features

- Good creep resistance
- Service temperature up to 700°C(1292°F)
- Easy to remove slag
- Low spatter
- Good bead appearance

## Welding Position



1G (PA) 2F (PB) 3G (PF) 4G (PE)

## Current

AC or DC ±

## Redrying Conditions

350°C (662°F) X 1 hr

## Diameter / Packaging

Diameter	Length	P.V.C	
		packet	carton
mm (in)	mm (in)	2.5kg(5.5lbs)	10kg(22lbs)
2.6 (3/32)	350 (14)	✓	
3.2 (1/8)	350 (14)	✓	
4.0 (5/32)	400 (16)	✓	
5.0 (3/16)	400 (16)	✓	
6.0 (15/64)	450 (18)	✓	

## Typical Chemical Composition of All-Weld Metal (%)

C	Si	Mn	P	S	Cr	Ni
0.05	0.65	0.90	0.03	0.02	18.9	9.9

## Typical Mechanical Properties of All-Weld Metal

TS MPa(lbs/in <sup>2</sup> )	EL (%)
590 (85,500)	40.0

## Typical Operating Procedures

Diameter mm (in)	2.0 (5/64)	2.6 (3/32)	3.2 (1/8)	4.0 (5/32)	5.0 (3/16)
Length mm (in)	300 (12)	300 (12)	350 (14)	350 (14)	350 (14)
F & HF	25~55A	50~85A	70~115A	95~145A	135~180A
V-up, OH	20~50A	45~80A	65~110A	85~135A	-

# S-308L.16N[17]

Type : Rutile, Rutile-acid



## Conformances

AWS A5.4/ ASME SFA5.4 E308L-16  
 JIS Z3221 ES308L-16 / EN ISO 3581-A-E 19 9 L R  
 EN ISO 3581-A-E 19 9 L R  
 AWS A5.4 / ASME SFA5.4 E308L-17  
 JIS Z3221 ES308L-17 / EN ISO 3581 E 19 9 L R  
 KR RD308L  
 ABS AWS A5.4 E308L-16  
 AWS A5.4 E308L-17  
 LR 304L

DNV 308L  
 NK KD308L  
 BV 308L  
 CWB CSA W48 E308L-16  
 TÜV EN ISO 3581-A - E 19 9 L R  
 CE  
 DB DIN EN ISO 3581-A-E 199 L R  
 CCS 304L

## Applications

- Stainless steel (low carbon 18%Cr-8%Ni)

## Features

- Good resistance to corrosion and oxidizing environments
- Easy to remove slag
- Good bead appearance
- High moisture resistance (17 type)

## Welding Position



1G 2F 3G 4G  
 (PA) (PB) (PF) (PE)

## Current

AC or DC ±

## Redrying Conditions

350°C (662°F) X 1hr

## Diameter / Packaging

Diameter	Length	Standard		Vacuum				P.V.C	
		packet	carton	packet	carton	packet	carton	packet	carton
mm (in)	mm (in)	5kg(11lbs)	20kg(44lbs)	1.5kg(3.3lbs)	15kg(3.3lbs)	5kg(11lbs)	20kg(44lbs)	2.5kg(11lbs)	10kg(22lbs)
2.0 (5/64)	300 (12)								✓
2.6 (3/32)	300 (12)								✓
3.2 (1/8)	350 (14)								✓
4.0 (5/32)	350 (14)								✓
5.0 (3/16)	350 (14)								✓

SMAW

SAW

GMAW

GTAW

FCAW

Non-FERROUS

APPENDIX

### Typical Chemical Composition of All-Weld Metal (%)

Product name	C	Si	Mn	P	S	Cr	Ni
S-308L.16N	0.02	0.67	0.87	0.028	0.018	19.2	10.0
S-308L.17	0.02	0.63	0.98	0.028	0.017	19.0	9.9

### Typical Mechanical Properties of All-Weld Metal

Product name	TS MPa(lbs/in <sup>2</sup> )	EL (%)
S-308L.16N	561 (81,500)	44.0
S-308L.17	570 (82,800)	49.0

### Typical Operating Procedures

Diameter mm (in)	2.0 (5/64)	2.6 (3/32)	3.2 (1/8)	4.0 (5/32)	5.0 (3/16)
Length mm (in)	300 (12)	300 (12)	350 (14)	350 (14)	350 (14)
F & HF	25~55A	50~85A	70~115A	95~145A	135~180A
V-up, OH	20~50A	45~80A	65~110A	85~135A	-



# S-308Mo.16

Type : Rutile

## Conformances

AWS A5.4/ ASME SFA5.4 E308Mo-16

JIS Z3221 ES308Mo-16

EN ISO 3581-A-E 20 10 3

## Applications

- Stainless steel (ASTM CF8M)

## Features

- Easy to remove slag
- Smooth welding
- Low spatter

## Welding Position



1G (PA) 2F (PB) 3G (PF) 4G (PE)

## Current

AC or DC ±

## Redrying Conditions

350°C (662°F) X 1hr

## Diameter / Packaging

Diameter	Length	P.V.C	
		packet	carton
mm (in)	mm (in)	2.5kg(5.5lbs)	10kg(22lbs)
2.6 (3/32)	350 (14)	✓	
3.2 (1/8)	350 (14)	✓	
4.0 (5/32)	400 (16)	✓	
5.0 (3/16)	400 (16)	✓	
6.0 (15/64)	450 (18)	✓	

## Typical Chemical Composition of All-Weld Metal (%)

C	Si	Mn	P	S	Cr	Ni	Mo
0.03	0.65	0.77	0.032	0.017	18.5	9.7	2.3

## Typical Mechanical Properties of All-Weld Metal

TS MPa(lbs/in <sup>2</sup> )	EL (%)
621 (90,200)	42.3

## Typical Operating Procedures

Diameter mm (in)	2.0 (5/64)	2.6 (3/32)	3.2 (1/8)	4.0 (5/32)	5.0 (3/16)
Length mm (in)	300 (12)	300 (12)	350 (14)	350 (14)	350 (14)
F & HF	25-55A	50-85A	70-115A	95-145A	135-180A
V-up, OH	20-50A	45-80A	65-110A	85-135A	-

SMW

SAW

GMW

GTAW

FCAW

Non-FERROUS

APPENDIX

# S-308LT.16

Type : Basic

## Conformances

AWS A5.4/ ASME SFA5.4 E308L-16  
 JIS Z3221 ES308L-16  
 EN ISO 3581-A-E 19 9 L R  
 ABS AWS A5.4 E308L-16 (-196°C)

## Applications

- Stainless steel (308L)
- LPG, LNG storage tank

## Features

- Good impact value up to -196°C
- Easy to remove slag
- Low spatter

## Welding Position



1G 2F 3G 4G  
 (PA) (PB) (PF) (PE)

## Current

AC or DC ±

## Redrying Conditions

350°C (662°F) X 1hr

## Diameter / Packaging

Diameter mm (in)	Length mm (in)	P.V.C	
		packet 2.5kg(5.5lbs)	carton 10kg(22lbs)
2.6 (3/32)	350 (14)	✓	
3.2 (1/8)	350 (14)	✓	
4.0 (5/32)	400 (16)	✓	
5.0 (3/16)	400 (16)	✓	
6.0 (15/64)	450 (18)	✓	

## Typical Chemical Composition of All-Weld Metal (%)

C	Si	Mn	P	S	Cr	Ni
0.035	0.77	1.74	0.023	0.012	19.2	9.9

## Typical Mechanical Properties of All-Weld Metal

TS MPa(lbs/in <sup>2</sup> )	EL (%)	Temp °C(°F)	CVN-Impact Value J (ft.-lbs)
576 (83,500)	49.8	-196 (-321)	36 (27)

## Typical Operating Procedures

Diameter mm (in)	2.0 (5/64)	2.6 (3/32)	3.2 (1/8)	4.0 (5/32)	5.0 (3/16)
Length mm (in)	300 (12)	300 (12)	350 (14)	350 (14)	350 (14)
F & HF	25~55A	50~85A	70~115A	95~145A	135~180A
V-up, OH	20~50A	45~80A	65~110A	85~135A	-

# S-309.16N

Type : Rutile

## Conformances

AWS A5.4/ ASME SFA5.4 E309-16  
 JIS Z3221 ES309-16  
 EN ISO 3581-A-E 23 12 R  
 KR RD309  
 ABS AWS A5.4 E309-16  
 DNV 309  
 LR SS/CMn

## Applications

- Welding of dissimilar steels

## Features

- Good resistance to heat and corrosion
- Easy to remove slag
- Low spatter

## Welding Position



1G 2F 3G 4G  
 (PA) (PB) (PF) (PE)

## Current

AC or DC ±

## Redrying Conditions

350°C (662°F) X 1hr

## Diameter / Packaging

Diameter	Length	P.V.C	
		packet	carton
mm (in)	mm (in)	2.5kg(5.5lbs)	10kg(22lbs)
2.6 (3/32)	350 (14)	✓	
3.2 (1/8)	350 (14)	✓	
4.0 (5/32)	400 (16)	✓	
5.0 (3/16)	400 (16)	✓	
6.0 (15/64)	450 (18)	✓	

## Typical Chemical Composition of All-Weld Metal (%)

C	Si	Mn	P	S	Cr	Ni
0.03	0.79	1.10	0.025	0.016	23.4	12.5

## Typical Mechanical Properties of All-Weld Metal

TS MPa(lbs/in <sup>2</sup> )	EL (%)
579 (84,100)	38.6

## Typical Operating Procedures

Diameter mm (in)	2.0 (5/64)	2.6 (3/32)	3.2 (1/8)	4.0 (5/32)	5.0 (3/16)
Length mm (in)	300 (12)	300 (12)	350 (14)	350 (14)	350 (14)
F & HF	25-55A	50-85A	70-115A	95-145A	135-180A
V-up, OH	20-50A	45-80A	65-110A	85-135A	-

SMW

SAW

GMW

GTAW

FCAW

Non-FERROUS

APPENDIX

# S-309L.16[17]

Type : Rutile, Rutile-acid



## Conformances

AWS A5.4/ ASME SFA5.4 E309L-16  
 JIS Z3221 ES309L-16 / EN ISO 3581-A-E 23 12 L R  
 AWS A5.4/ ASME SFA5.4 E309L-17  
 JIS Z3221 ES309L-17 / EN ISO 3581-A-E 23 12 L R  
 KR RD309L  
 ABS AWS A5.4 E309L-16  
 AWS A5.4 E309L-17  
 LR SS/CMn  
 BV UP

DNV 309L  
 NK KD309L  
 GL 4332  
 CWB CSA W48 E309L-16  
 TÜV EN ISO 3581-A - E 23 12 L R  
 CE  
 DB DIN EN ISO 3581-A-E 23 12 L R  
 CCS 309L

## Applications

- Welding of dissimilar steels
- Buffer layer for build-up

## Features

- Good resistance to heat and corrosion
- Good crack resistance
- Easy to remove slag
- High moisture resistance (17 type)

## Welding Position



1G 2F 3G 4G  
 (PA) (PB) (PF) (PE)

## Current

AC or DC ±

## Redrying Conditions

350°C (662°F) X 1hr

## Diameter / Packaging

Diameter	Length	Standard		Vacuum				P.V.C	
		packet	carton	packet	carton	packet	carton	packet	carton
mm (in)	mm (in)	5kg(11lbs)	20kg(44lbs)	1.5kg(3.3lbs)	15kg(3.3lbs)	5kg(11lbs)	20kg(44lbs)	2.5kg(11lbs)	10kg(22lbs)
2.0 (5/64)	300 (12)								✓
2.6 (3/32)	300 (12)								✓
3.2 (1/8)	350 (14)								✓
4.0 (5/32)	350 (14)								✓
5.0 (3/16)	350 (14)								✓

### Typical Chemical Composition of All-Weld Metal (%)

Product name	C	Si	Mn	P	S	Cr	Ni
S-309L.16	0.02	0.76	1.21	0.028	0.018	22.9	12.7
S-309L.17	0.02	0.63	1.15	0.028	0.017	23.1	12.8

### Typical Mechanical Properties of All-Weld Metal

Product name	TS MPa(lbs/in <sup>2</sup> )	EL (%)
S-309L.16N	563 (81,800)	43.0
S-309L.17	570 (82,800)	43.0

### Typical Operating Procedures

Diameter mm (in)	2.0 (5/64)	2.6 (3/32)	3.2 (1/8)	4.0 (5/32)	5.0 (3/16)
Length mm (in)	300 (12)	300 (12)	350 (14)	350 (14)	350 (14)
F & HF	25-55A	50-85A	70-115A	95-145A	135-180A
V-up, OH	20-50A	45-80A	65-110A	85-135A	-

SMAW

SAW

GMAW

GTAW

FCAW

Non-FERROUS

APPENDIX

# S-309Mo.16

Type : Rutile

## Conformances

AWS A5.4/ ASME SFA5.4 E309Mo-16  
 JIS Z3221 ES309Mo-16  
 EN ISO 3581-A-E 23 12 2 R  
 ABS AWS A5.4 E309Mo-16

## Applications

- Welding of dissimilar steels (root pass)

## Features

- Good resistance to heat and crack
- Easy to remove slag
- Good bead appearance

## Welding Position



1G 2F 3G 4G  
 (PA) (PB) (PF) (PE)

## Current

AC or DC ±

## Redrying Conditions

350°C (662°F) X 1hr

## Diameter / Packaging

Diameter mm (in)	Length mm (in)	P.V.C	
		packet 2.5kg(5.5lbs)	carton 10kg(22lbs)
2.6 (3/32)	350 (14)	✓	
3.2 (1/8)	350 (14)	✓	
4.0 (5/32)	400 (16)	✓	
5.0 (3/16)	400 (16)	✓	
6.0 (15/64)	450 (18)	✓	

## Typical Chemical Composition of All-Weld Metal (%)

C	Si	Mn	P	S	Cr	Ni	Mo
0.03	0.77	1.21	0.026	0.015	23.3	12.6	2.4

## Typical Mechanical Properties of All-Weld Metal

TS MPa(lbs/in <sup>2</sup> )	EL (%)
662 (96,100)	35.7

## Typical Operating Procedures

Diameter mm (in)	2.0 (5/64)	2.6 (3/32)	3.2 (1/8)	4.0 (5/32)	5.0 (3/16)
Length mm (in)	300 (12)	300 (12)	350 (14)	350 (14)	350 (14)
F & HF	25~55A	50~85A	70~115A	95~145A	135~180A
V-up, OH	20~50A	45~80A	65~110A	85~135A	-

# S-309MoL.16

Type : Rutile



## Conformances

AWS A5.4/ ASME SFA5.4 E309LMO-16  
 JIS Z3221 ES309LMO-16  
 EN ISO 3581-A-E 23 12 2 L R  
 DNV 309MoL (-20°C)  
 TÜV EN ISO 3581-A - E 23 12 2 L R  
 CE  
 DB EN ISO 3581-A-E 23 12 2 L R

## Applications

- Welding of dissimilar steels
- Welding of low carbon 22%Cr-12%Ni-2.5%Mo stainless steel

## Features

- Good resistance to heat and crack
- Easy to remove slag
- Good bead appearance

## Welding Position



1G 2F 3G 4G  
 (PA) (PB) (PF) (PE)

## Current

AC or DC ±

## Redrying Conditions

350°C (662°F) X 1hr

## Diameter / Packaging

Diameter	Length	P.V.C	
		packet	carton
2.6 (3/32)	350 (14)	2.5kg(5.5lbs)	10kg(22lbs)
3.2 (1/8)	350 (14)	✓	✓
4.0 (5/32)	400 (16)	✓	✓
5.0 (3/16)	400 (16)	✓	✓
6.0 (15/64)	450 (18)	✓	✓

## Typical Chemical Composition of All-Weld Metal (%)

C	Si	Mn	P	S	Cr	Ni	Mo
0.02	0.72	1.30	0.027	0.013	23.3	12.7	2.4

## Typical Mechanical Properties of All-Weld Metal

TS MPa(lbs/in <sup>2</sup> )	EL (%)
690 (99,000)	33.8

## Typical Operating Procedures

Diameter mm (in)	2.0 (5/64)	2.6 (3/32)	3.2 (1/8)	4.0 (5/32)	5.0 (3/16)
Length mm (in)	300 (12)	300 (12)	350 (14)	350 (14)	350 (14)
F & HF	25-55A	50-85A	70-115A	95-145A	135-180A
V-up, OH	20-50A	45-80A	65-110A	85-135A	-

SMAW

SAW

GMAW

GTAW

FCAW

Non-FERROUS

APPENDIX

# S-310.15

Type : Basic(Lime)

## Conformances

AWS A5.4/ ASME SFA5.4 E310-15

JIS Z3221 ES310-15

EN ISO 3581-A-E 25 20 B

## Applications

- Welding of 13%Cr or clad part of 18%Cr-8%Ni steel

## Features

- Basic type electrode
- Good mechanical properties
- Martensite structure (All-weld metal)

## Welding Position



1G 2F 3G 4G  
(PA) (PB) (PF) (PE)

## Current

DC ±

## Redrying Conditions

350°C (662°F) X 1hr

## Diameter / Packaging

Diameter	Length	P.V.C	
		packet	carton
mm (in)	mm (in)	2.5kg(5.5lbs)	10kg(22lbs)
2.6 (3/32)	350 (14)	✓	
3.2 (1/8)	350 (14)	✓	
4.0 (5/32)	400 (16)	✓	
5.0 (3/16)	400 (16)	✓	
6.0 (15/64)	450 (18)	✓	

## Typical Chemical Composition of All-Weld Metal (%)

C	Si	Mn	P	S	Cr	Ni
0.10	0.60	1.90	0.018	0.013	26.5	20.6

## Typical Mechanical Properties of All-Weld Metal

TS MPa(lbs/in <sup>2</sup> )	EL (%)
610 (88,400)	35.0

## Typical Operating Procedures

Diameter mm (in)	2.0 (5/64)	2.6 (3/32)	3.2 (1/8)	4.0 (5/32)	5.0 (3/16)
Length mm (in)	300 (12)	300 (12)	350 (14)	350 (14)	350 (14)
F & HF	25~55A	50~85A	70~115A	95~145A	135~180A
V-up, OH	20~50A	45~80A	65~110A	85~135A	-



# S-310.16

Type : Rutile

## Conformances

AWS A5.4/ ASME SFA5.4 E310-16

JIS Z3221 ES310-16

EN ISO 3581-A-E 25 20 R

## Applications

- Stainless steel (25%Cr-20%Ni)

## Features

- Good heat resistance
- Good mechanical properties
- Martensite structure (All-weld metal)
- Easy to remove slag

## Welding Position



1G (PA) 2F (PB) 3G (PF) 4G (PE)

## Current

AC or DC ±

## Redrying Conditions

350°C (662°F) X 1hr

## Diameter / Packaging

Diameter	Length	P.V.C	
		packet	carton
mm (in)	mm (in)	2.5kg(5.5lbs)	10kg(22lbs)
2.6 (3/32)	350 (14)	✓	
3.2 (1/8)	350 (14)	✓	
4.0 (5/32)	400 (16)	✓	
5.0 (3/16)	400 (16)	✓	
6.0 (15/64)	450 (18)	✓	

## Typical Chemical Composition of All-Weld Metal (%)

C	Si	Mn	P	S	Cr	Ni
0.10	0.60	1.90	0.018	0.013	26.5	20.6

## Typical Mechanical Properties of All-Weld Metal

TS MPa(lbs/in <sup>2</sup> )	EL (%)
610 (88,400)	35.0

## Typical Operating Procedures

Diameter mm (in)	2.0 (5/64)	2.6 (3/32)	3.2 (1/8)	4.0 (5/32)	5.0 (3/16)
Length mm (in)	300 (12)	300 (12)	350 (14)	350 (14)	350 (14)
F & HF	25-55A	50-85A	70-115A	95-145A	135-180A
V-up, OH	20-50A	45-80A	65-110A	85-135A	-

SMW

SAW

GMW

GTAW

FCW

Non-FERROUS

APPENDIX

# S-312.16

Type : Basic

## Conformances

AWS A5.4/ ASME SFA5.4 E312-16

JIS Z3221 ES312-16

EN ISO 3581-A-E 299 R

## Applications

- Welding of dissimilar steels
- Buffer layer for build-up

## Features

- Good crack resistance
- Excellent buffer effect against stress
- Easy to remove slag

## Welding Position



1G 2F 3G 4G  
(PA) (PB) (PF) (PE)

## Current

AC or DC ±

## Redrying Conditions

350°C (662°F) X 1hr

## Diameter / Packaging

Diameter	Length	P.V.C	
		packet	carton
mm (in)	mm (in)	2.5kg(5.5lbs)	10kg(22lbs)
2.6 (3/32)	350 (14)	✓	
3.2 (1/8)	350 (14)	✓	
4.0 (5/32)	400 (16)	✓	
5.0 (3/16)	400 (16)	✓	
6.0 (15/64)	450 (18)	✓	

## Typical Chemical Composition of All-Weld Metal (%)

C	Si	Mn	P	S	Cr	Ni
0.11	0.49	1.41	0.021	0.013	29.5	9.5

## Typical Mechanical Properties of All-Weld Metal

TS MPa(lbs/in <sup>2</sup> )	EL (%)
803 (116,600)	22.0

## Typical Operating Procedures

Diameter mm (in)	2.0 (5/64)	2.6 (3/32)	3.2 (1/8)	4.0 (5/32)	5.0 (3/16)
Length mm (in)	300 (12)	300 (12)	350 (14)	350 (14)	350 (14)
F & HF	25~55A	50~85A	70~115A	95~145A	135~180A
V-up, OH	20~50A	45~80A	65~110A	85~135A	-

# S-316.16N

Type : Rutile

## Conformances

AWS A5.4/ ASME SFA5.4 E316-16  
 JIS Z3221 ES316-16  
 EN ISO 3581-A-E 19 12 3 R  
 KR RD316  
 ABS AWS A5.4 E316-16  
 BV UP (E316-16, -20°C)  
 DNV 316

## Applications

- Stainless steel (18%Cr-12%Ni-2%Mo)

## Features

- Good resistance to corrosion and oxidizing environments
- Good heat resistance
- asy to remove slag
- Low spatter

## Welding Position



1G 2F 3G 4G  
 (PA) (PB) (PF) (PE)

## Current

AC or DC ±

## Redrying Conditions

350°C (662°F) X 1hr

## Diameter / Packaging

Diameter	Length	P.V.C	
		packet	carton
mm (in)	mm (in)	2.5kg(5.5lbs)	10kg(22lbs)
2.6 (3/32)	350 (14)	✓	
3.2 (1/8)	350 (14)	✓	
4.0 (5/32)	400 (16)	✓	
5.0 (3/16)	400 (16)	✓	
6.0 (15/64)	450 (18)	✓	

## Typical Chemical Composition of All-Weld Metal (%)

C	Si	Mn	P	S	Cr	Ni	Mo
0.03	0.77	0.9	0.03	0.029	18.7	12.3	2.5

## Typical Mechanical Properties of All-Weld Metal

TS MPa(lbs/in <sup>2</sup> )	EL (%)
572 (83,100)	40.8

## Typical Operating Procedures

Diameter mm (in)	2.0 (5/64)	2.6 (3/32)	3.2 (1/8)	4.0 (5/32)	5.0 (3/16)
Length mm (in)	300 (12)	300 (12)	350 (14)	350 (14)	350 (14)
F & HF	25-55A	50-85A	70-115A	95-145A	135-180A
V-up, OH	20-50A	45-80A	65-110A	85-135A	-

SMW

SAW

GMW

GTAW

FCAW

Non-FERROUS

APPENDIX

# S-316L.16N[17]

Type : Rutile, Rutile-acid



## Conformances

AWS A5.4/ ASME SFA5.4 E316L-16

JIS Z3221 ES316L-16 / EN ISO 3581-A-E 19 12 3 L R

AWS A5.4/ ASME SFA5.4 E316L-17

JIS Z3221 ES316L-17 / EN ISO 3581-A-E 19 12 3 L R

KR RD316L

ABS AWS A5.4 E316L-16

AWS A5.4 E316L-17

LR 316L

BV UP (E316L-16, -20°C)

DNV 316L

NK KD316L

CWB CSA W48 E316L-16

TÜV EN ISO 3581-A - E 19 12 3 L R

CE

DB EN ISO 3581-A-E 19 12 3 L R

CCS 316L

## Applications

- Stainless steel (low carbon 18%Cr-12%Ni-2%Mo)

## Features

- Good resistance to corrosion and oxidizing environments
- Good heat resistance
- Easy to remove slag
- High moisture resistance (17 type)

## Welding Position



1G 2F 3G 4G  
(PA) (PB) (PF) (PE)

## Current

AC or DC ±

## Redrying Conditions

350°C (662°F) X 1hr

## Diameter / Packaging

Diameter	Length	Standard		Vacuum				P.V.C	
		packet	carton	packet	carton	packet	carton	packet	carton
mm (in)	mm (in)	5kg(11lbs)	20kg(44lbs)	1.5kg(3.3lbs)	15kg(3.3lbs)	5kg(11lbs)	20kg(44lbs)	2.5kg(11lbs)	10kg(22lbs)
2.0 (5/64)	300 (12)								✓
2.6 (3/32)	300 (12)								✓
3.2 (1/8)	350 (14)								✓
4.0 (5/32)	350 (14)								✓
5.0 (3/16)	350 (14)								✓

### Typical Chemical Composition of All-Weld Metal (%)

Product name	C	Si	Mn	Cr	Ni	Mo
S-316L.16N	0.02	0.75	1.10	18.5	12.7	2.5
S-316L.17	0.02	0.73	1.33	23.1	12.8	2.5

### Typical Mechanical Properties of All-Weld Metal

Product name	TS MPa(lbs/in <sup>2</sup> )	EL (%)
S-316L.16N	557 (80,900)	45.2
S-316L.17	560 (81,300)	48.0

### Typical Operating Procedures

Diameter mm (in)	2.0 (5/64)	2.6 (3/32)	3.2 (1/8)	4.0 (5/32)	5.0 (3/16)
Length mm (in)	300 (12)	300 (12)	350 (14)	350 (14)	350 (14)
F & HF	25-55A	50-85A	70-115A	95-145A	135-180A
V-up, OH	20-50A	45-80A	65-110A	85-135A	-

SMAW

SAW

GMAW

GTAW

FCAW

Non-FERROUS

APPENDIX

# S-316LT.16

Type : Basic

## Conformances

AWS A5.4/ ASME SFA5.4 E316L-16  
 JIS Z3221 ES316L-16  
 EN ISO 3581-A-E 19 12 3 L R  
 ABS AWS A5.4 E316L-16 (-196°C)

## Applications

- Stainless steel (18%Cr-12%Ni-2%Mo)
- LPG, LNG storage tank

## Features

- Good impact value up to -196°C
- Good resistance to inter-crystalline corrosion
- Easy to remove slag
- Low spatter

## Welding Position



1G 2F 3G 4G  
 (PA) (PB) (PF) (PE)

## Current

AC or DC ±

## Redrying Conditions

350°C (662°F) X 1hr

## Diameter / Packaging

Diameter mm (in)	Length mm (in)	P.V.C	
		packet 2.5kg(5.5lbs)	carton 10kg(22lbs)
2.6 (3/32)	350 (14)	✓	
3.2 (1/8)	350 (14)	✓	
4.0 (5/32)	400 (16)	✓	
5.0 (3/16)	400 (16)	✓	
6.0 (15/64)	450 (18)	✓	

## Typical Chemical Composition of All-Weld Metal (%)

C	Si	Mn	P	S	Cr	Ni	Mo
0.035	0.55	1.59	0.021	0.016	18.5	13.5	2.5

## Typical Mechanical Properties of All-Weld Metal

TS MPa(lbs/in <sup>2</sup> )	EL (%)	Temp °C(°F)	CVN-Impact Value J (ft.-lbs)
538 (78,000)	34.4	-196 (-321)	36 (27)

## Typical Operating Procedures

Diameter mm (in)	2.0 (5/64)	2.6 (3/32)	3.2 (1/8)	4.0 (5/32)	5.0 (3/16)
Length mm (in)	300 (12)	300 (12)	350 (14)	350 (14)	350 (14)
F & HF	25~55A	50~85A	70~115A	95~145A	135~180A
V-up, OH	20~50A	45~80A	65~110A	85~135A	-

# S-317.16

Type : Rutile

## Conformances

AWS A5.4/ ASME SFA5.4 E317-16

JIS Z3221 ES317-16

## Applications

- Stainless steel (317L)

## Features

- Good resistance to nitroxide and sulfide
- Good heat resistance
- Easy to remove slag

## Welding Position



1G 2F 3G 4G  
(PA) (PB) (PF) (PE)

## Current

AC or DC ±

## Redrying Conditions

350°C (662°F) X 1hr

## Diameter / Packaging

Diameter	Length	P.V.C	
		packet	carton
mm (in)	mm (in)	2.5kg(5.5lbs)	10kg(22lbs)
2.6 (3/32)	350 (14)	✓	
3.2 (1/8)	350 (14)	✓	
4.0 (5/32)	400 (16)	✓	
5.0 (3/16)	400 (16)	✓	
6.0 (15/64)	450 (18)	✓	

## Typical Chemical Composition of All-Weld Metal (%)

C	Si	Mn	P	S	Cr	Ni	Mo
0.02	0.63	1.05	0.029	0.018	18.3	12.6	3.2

## Typical Mechanical Properties of All-Weld Metal

TS MPa(lbs/in <sup>2</sup> )	EL (%)
558 (85,400)	38.4

## Typical Operating Procedures

Diameter mm (in)	2.0 (5/64)	2.6 (3/32)	3.2 (1/8)	4.0 (5/32)	5.0 (3/16)
Length mm (in)	300 (12)	300 (12)	350 (14)	350 (14)	350 (14)
F & HF	25-55A	50-85A	70-115A	95-145A	135-180A
V-up, OH	20-50A	45-80A	65-110A	85-135A	-

SMW

SAW

GMW

GTAW

FCAW

Non-FERROUS

APPENDIX

# S-347.16

Type : Rutile

## Conformances

AWS A5.4/ ASME SFA5.4 E347-16

JIS Z3221 ES347-16

EN ISO 3581-A-E 199 Nb R

## Applications

- Stainless steel (321, 347)

## Features

- Contains stabilizing element(Nb)
- High temperature strength
- Suitable for welding of boiler and gas turbine
- Easy to remove slag

## Welding Position



1G 2F 3G 4G  
(PA) (PB) (PF) (PE)

## Current

AC or DC ±

## Redrying Conditions

350°C (662°F) X 1hr

## Diameter / Packaging

Diameter mm (in)	Length mm (in)	P.V.C	
		packet 2.5kg(5.5lbs)	carton 10kg(22lbs)
2.6 (3/32)	350 (14)	✓	
3.2 (1/8)	350 (14)	✓	
4.0 (5/32)	400 (16)	✓	
5.0 (3/16)	400 (16)	✓	
6.0 (15/64)	450 (18)	✓	

## Typical Chemical Composition of All-Weld Metal (%)

C	Si	Mn	P	S	Cr	Ni	Nb
0.02	0.75	0.82	0.027	0.014	18.5	9.8	0.35

## Typical Mechanical Properties of All-Weld Metal

TS MPa(lbs/in <sup>2</sup> )	EL (%)
603 (87,600)	42.4

## Typical Operating Procedures

Diameter mm (in)	2.0 (5/64)	2.6 (3/32)	3.2 (1/8)	4.0 (5/32)	5.0 (3/16)
Length mm (in)	300 (12)	300 (12)	350 (14)	350 (14)	350 (14)
F & HF	25~55A	50~85A	70~115A	95~145A	135~180A
V-up, OH	20~50A	45~80A	65~110A	85~135A	-



# S-2209.16

Type : Rutile

## Conformances

AWS A5.4/ ASME SFA5.4 E2209-16

JIS Z3221 ES2209-16

EN ISO 3581-A-E 22 9 3 N L

## Applications

- Welding of duplex stainless steel (SAF2205, UNS S31803)

## Features

- Ferritic/austenitic structure (All-weld metal)
- Service temperature up to 250°C
- High resistance to pitting, intergranular and stress corrosion
- PREN 35
- Easy to remove slag
- Good bead appearance

## Welding Position



1G (PA) 2F (PB) 3G (PF) 4G (PE)

## Current

AC or DC ±

## Redrying Conditions

350°C (662°F) X 1hr

## Diameter / Packaging

Diameter mm (in)	Length mm (in)	P.V.C	
		packet 2.5kg(5.5lbs)	carton 10kg(22lbs)
2.6 (3/32)	350 (14)	✓	
3.2 (1/8)	350 (14)	✓	
4.0 (5/32)	400 (16)	✓	
5.0 (3/16)	400 (16)	✓	
6.0 (15/64)	450 (18)	✓	

## Typical Chemical Composition of All-Weld Metal (%)

C	Si	Mn	Cr	Ni	Mo	N
0.029	0.78	1.03	23.1	9.2	3.1	0.12

## Typical Mechanical Properties of All-Weld Metal

TS MPa(lbs/in <sup>2</sup> )	EL (%)	Temp °C(°F)	CVN-Impact Value J (ft.lbs)
830 (120,400)	28.0	-20(-4) -50(-58)	50 (37) 45 (33)

## Typical Operating Procedures

Diameter mm (in)	2.0 (5/64)	2.6 (3/32)	3.2 (1/8)	4.0 (5/32)	5.0 (3/16)
Length mm (in)	300 (12)	300 (12)	350 (14)	350 (14)	350 (14)
F & HF	25-55A	50-85A	70-115A	95-145A	135-180A
V-up, OH	20-50A	45-80A	65-110A	85-135A	-

SMAW

SAW

GM/AMW

GTAW

FCAW

Non-FERROUS

APPENDIX

# S-2594.16

Type : Rutile

## Conformances

AWS A5.4/ ASME SFA5.4 E2594-16

EN ISO 3581-A-E 25 9 4 N L

## Applications

- Welding of super duplex stainless steel (UNS S32750, S32760)

## Features

- Service temperature up to 250°C
- High resistance to Pitting corrosion and embrittlement
- PREN 41
- Easy to remove slag
- Good bead appearance

## Welding Position



1G 2F  
(PA) (PB)

## Current

AC or DC ±

## Redrying Conditions

350°C (662°F) X 1hr

## Diameter / Packaging

Diameter mm (in)	Length mm (in)	P.V.C	
		packet 2.5kg(5.5lbs)	carton 10kg(22lbs)
2.6 (3/32)	350 (14)	✓	
3.2 (1/8)	350 (14)	✓	
4.0 (5/32)	400 (16)	✓	
5.0 (3/16)	400 (16)	✓	
6.0 (15/64)	450 (18)	✓	

## Typical Chemical Composition of All-Weld Metal (%)

C	Si	Mn	Cr	Ni	Mo	N
0.019	0.58	0.53	25.17	8.9	3.9	0.22

## Typical Mechanical Properties of All-Weld Metal

TS MPa(lbs/in <sup>2</sup> )	EL (%)	Temp °C(°F)	CVN-Impact Value J (ft.-lbs)
830 (120,400)	28.0	-20(-4) -50(-58)	35 (25) 30 (22)

## Typical Operating Procedures

Diameter mm (in)	2.0 (5/64)	2.6 (3/32)	3.2 (1/8)	4.0 (5/32)	5.0 (3/16)
Length mm (in)	300 (12)	300 (12)	350 (14)	350 (14)	350 (14)
F & HF	25~55A	50~85A	70~115A	95~145A	135~180A
V-up, OH	20~50A	45~80A	65~110A	85~135A	-

# S-NCI

Type : Basic

## Conformances

AWS A5.15/ ASME SFA5.15 ENi-CI

JIS Z3252 DFCNi

EN ISO 1071 - E C Ni-CI 1

## Applications

- Repairing and joining of cast iron

## Features

- Graphite coated electrode
- Preheat at 150°C (302°F)

## Welding Position



1G 2F  
(PA) (PB)

## Current

AC or DC ±

## Redrying Conditions

350°C (662°F) X 1 hr

## Diameter / Packaging

Diameter	Length	P.V.C	
		packet	carton
mm (in)	mm (in)	2.5kg(5.5lbs)	10kg(22lbs)
2.6 (3/32)	350 (14)		✓
3.2 (1/8)	350 (14)		✓
4.0 (5/32)	400 (16)		✓
5.0 (3/16)	400 (16)		✓
6.0 (15/64)	450 (18)		✓

## Typical Chemical Composition of All-Weld Metal (%)

C	Si	Mn	P	S	Fe	Ni
1.38	0.79	0.36	0.004	0.003	0.58	98.3

## Typical Mechanical Properties of All-Weld Metal

Hardness (HRB)
77.6

## Typical Operating Procedures

Diameter mm (in)	2.6 (3/32)	3.2 (1/8)	4.0 (5/32)
Length mm (in)	300 (12)	350 (14)	350 (14)
F	55-80	80-130	110-160

SWAW

SAW

GMAW

GTAW

FCAW

Non-FERROUS

APPENDIX

# S-NFC

Type : Basic

## Conformances

AWS A5.15/ ASME SFA5.15 ENiFe-CI

JIS Z3252 DFCNiFe

EN ISO 1071 - E C NiFe-CI 1

## Applications

- Welding of normal grades of cast iron

## Features

- Good crack resistance
- Preheat at 100~200°C (212~392°F)
- Easy to remove slag

## Welding Position



1G 2F  
(PA) (PB)

## Current

AC or DC ±

## Redrying Conditions

350°C (662°F) X 1hr

## Diameter / Packaging

Diameter	Length	P.V.C	
		packet	carton
mm (in)	mm (in)	2.5kg(5.5lbs)	10kg(22lbs)
2.6 (3/32)	350 (14)		✓
3.2 (1/8)	350 (14)		✓
4.0 (5/32)	400 (16)		✓
5.0 (3/16)	400 (16)		✓
6.0 (15/64)	450 (18)		✓

## Typical Chemical Composition of All-Weld Metal (%)

C	Si	Mn	P	S	Fe	Ni
1.17	0.80	1.2	0.010	0.003	54.0	Bal

## Typical Mechanical Properties of All-Weld Metal

Hardness (HRB)
90

## Typical Operating Procedures

Diameter mm (in)	3.2 (1/8)	4.0 (5/32)
Length mm (in)	350 (14)	350 (14)
F	80~130	110~160

# S-FCF

Type : Basic

## Conformances

AWS A5.15/ ASME SFA5.15 ESt

JIS Z3252 DFCFe

EN ISO 1071 - E Z 1

## Applications

- Repairing of cast iron

## Features

- Machining impossible (As welded)
- Easy to remove slag
- Preheat at 200~350°C (392~662°F)
- Stable arc and good bead appearance

## Welding Position



1G 2F  
(PA) (PB)

## Current

AC or DC ±

## Redrying Conditions

350°C (662°F) X 1hr

## Diameter / Packaging

Diameter	Length	P.V.C	
		packet	carton
mm (in)	mm (in)	2.5kg(5.5lbs)	10kg(22lbs)
2.6 (3/32)	350 (14)		✓
3.2 (1/8)	350 (14)		✓
4.0 (5/32)	400 (16)		✓
5.0 (3/16)	400 (16)		✓
6.0 (15/64)	450 (18)		✓

## Typical Chemical Composition of All-Weld Metal (%)

C	Si	Mn	P	S	Fe
2.47	0.41	0.45	0.024	0.024	99.6

## Typical Mechanical Properties of All-Weld Metal

Hardness (HRB)

450-510

## Typical Operating Procedures

Diameter mm (in)	2.6 (3/32)	3.2 (1/8)	4.0 (5/32)	5.0 (3/16)
Length mm (in)	300 (12)	350 (14)	350 (14)	400 (16)
F	55-80	80-130	110-160	150-200

SMAW

SAW

GMAW

GTAW

FCAW

Non-FERROUS

APPENDIX

# Note

---

# SAW

## Wire/Flux Combination



# S-777MX X H-14

Type : Neutral

## Conformances

AWS A5.17/ ASME SFA5.17 F7A0-EH14  
 JIS Z3183 S502-H  
 EN ISO 14174 S A AR 1 / EN ISO 14171 S4  
 KR 2M, 2YM  
 ABS 2M, 2YM

LR 2M, 2YM  
 BV A2M, A2YM  
 DNV IIYM  
 GL 2YM  
 NK KAW2M, KAW52M

## Applications

- LPG tanks
- Spiral pipes
- Agricultural implements

## Features

- Easy to remove slag
- High speed welding
- Horizontal and flat fillet welding
- Density : 1.0g/cm<sup>3</sup>

## Current

AC, DC +

## Basicity Index

0.5

## Packages (Flux)

Tin Can 20kg(44lbs)  
 PE Bag 20kg(44lbs)

## Flux Composition

Consumable	Chemical Composition, wt%		
	Al <sub>2</sub> O <sub>3</sub> + TiO <sub>2</sub>	SiO <sub>2</sub> + MnO	CaO + MgO
S-777MX	55	25	20

## Diameter / Packaging

Diameter mm (in)	Spool		Basket		Coil					Pac				
	20kg (44lbs)	25kg (55lbs)	100kg (220lbs)	25kg (55lbs)	100kg (220lbs)	200kg (440lbs)	250kg (551lbs)	300kg (661lbs)	500kg (1102lbs)	200kg (440lbs)	250kg (551lbs)	300kg (661lbs)	350kg (771lbs)	400kg (881lbs)
1.6 (1/16)	✓			✓							✓			✓
2.0 (5/64)	✓			✓	✓	✓	✓					✓		
2.4 (3/32)	✓	✓		✓	✓	✓								
3.2 (1/8)		✓		✓	✓	✓	✓	✓			✓	✓	✓	
4.0 (5/32)		✓		✓	✓	✓		✓	✓	✓	✓	✓	✓	✓
4.8 (3/16)	✓			✓	✓			✓	✓					
6.4 (1/4)				✓	✓									



**Typical Chemical Composition of All-Weld Metal(%)**

Wire	C	Si	Mn	P	S	BM	Th.(mm)
H-14	0.08	0.53	0.94	0.021	0.014	SS400	25

**Typical Mechanical Properties of All-Weld Metal**

Wire	YS MPa(lbs/in <sup>2</sup> )	TS MPa(lbs/in <sup>2</sup> )	EL (%)	Temp °C(°F)	CVN-Impact Value J (ft-lbs)	BM	Th.(mm)
H-14	560 (81,000)	620 (90,000)	27	-18 (0)	48 (35)	SS400	25
	-	530 (76,900)	-	-5 (23)	72 (53)	SM490	20

**Typical Welding Conditions**

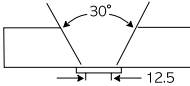
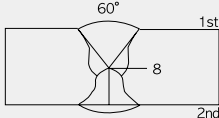
Wire	Dia. (mm)	Th. (mm)	Groove Design (mm)	Pass	Amp. (A)	Volt. (V)	Speed (cm/min)	Remarks
H-14	4.0	25		1~13	570	30	40	AWS A5.17
H-14	4.8	20			800 850	36 37	25 45	Both Single pass

SWAW

SAW

GMAW

GTAW

FCAW

Non-FERROUS

APPENDIX

# S-777MXT X H-14(M-12K)

Type : Neutral

## Conformances

AWS A5.17/ ASME SFA5.17 F7A0-EH14  
 AWS A5.17/ ASME SFA5.17 F7A(P)Z-EM12K  
 EN ISO 14174 S A AR 1 / EN ISO 14171 S4[S2Si]

## Applications

- LPG tanks
- Boiler(Fin tube)

## Features

- Easy to remove slag
- High speed welding
- Density : 1.0g/cm<sup>3</sup>

## Current

AC, DC +

## Basicity Index

0.5

## Packages (Flux)

Tin Can 20kg(44lbs)  
 PE Bag 20kg(44lbs)

## Flux Composition

Consumable	Chemical Composition, wt%		
	Al <sub>2</sub> O <sub>3</sub> + Fe <sub>2</sub> O <sub>3</sub>	TiO <sub>2</sub> + MnO	SiO <sub>2</sub> + CaO
S-777MXT	55	25	15

## Diameter / Packaging

- H-14 : ✓
- M-12K : ○

Diameter	Spool		Basket		Coil					Pac				
	20kg (44lbs)	25kg (55lbs)	100kg (220lbs)	25kg (55lbs)	100kg (220lbs)	200kg (440lbs)	250kg (551lbs)	300kg (661lbs)	500kg (1102lbs)	200kg (440lbs)	250kg (551lbs)	300kg (661lbs)	350kg (771lbs)	400kg (881lbs)
1.6 (1/16)	✓○			✓○							✓		○	✓
2.0 (5/64)	✓○			✓○	✓	✓	✓				○	✓	○	○
2.4 (3/32)	✓	✓○	○	✓○	✓○	✓								○
3.2 (1/8)		✓○	○	✓○	✓○	✓	✓	✓		○	✓	✓	✓	○
4.0 (5/32)		✓○	○	✓○	✓○	✓○		✓	✓○	✓○	✓○	✓○	✓	✓○
4.8 (3/16)	✓			✓○	✓○			✓○	✓○	○				
6.4 (1/4)				✓	✓									

**Typical Chemical Composition of All-Weld Metal(%)**

Wire	C	Si	Mn	P	S	BM	Th.(mm)
H-14	0.09	0.52	1.18	0.023	0.013	SS400	25
M-12K	0.06	0.52	0.73	0.024	0.016	SS400	25

**Typical Mechanical Properties of All-Weld Metal**

Wire	YS MPa(lbs/in <sup>2</sup> )	TS MPa(lbs/in <sup>2</sup> )	EL (%)	CVN-Impact Value J (ft-lbs)		BM	Th.(mm)
				0°C (32°F)	-18°C (0°F)		
H-14	550 (79,800)	600 (87,000)	29.8	65 (48)	41 (30)	SS400	25
M-12K	510 (74,000)	560 (81,200)	28.6	42 (31)	-	SS400	25

**Typical Welding Conditions**

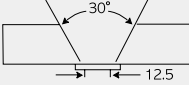
Wire	Dia. (mm)	Th. (mm)	Groove Design (mm)	Pass	Amp. (A)	Volt. (V)	Speed (cm/min)	Remarks
H-14 (M-12K)	4.0	25		1~13	570	30	40	AWS A5.17

SWAW

SAW

GM/AV

GTAW

FCAW

Non-FERROUS

APPENDIX

# S-777MXT X A-2(B-2)

Type : Neutral

## Conformances

AWS A5.23/ ASME SFA5.23 F8PZ-EA2-A2  
 AWS A5.23/ ASME SFA5.23 F8PZ-EB2-B2  
 EN ISO 14174 S A AR 1 / EN ISO 14171 S2Mo[S2CrMo1]

## Applications

- Heat resistant steels
- Fin-tube

## Features

- Easy to remove slag
- High speed welding
- Density : 1.0g/cm<sup>3</sup>

## Current

AC, DC +

## Basicity Index

0.5

## Packages (Flux)

Tin Can 20kg(44lbs)  
 PE Bag 20kg(44lbs)

## Flux Composition

Consumable	Chemical Composition, wt%		
	Al <sub>2</sub> O <sub>3</sub> + Fe <sub>2</sub> O <sub>3</sub>	TiO <sub>2</sub> + MnO	SiO <sub>2</sub> + CaO
S-777MXT	55	25	15

## Diameter / Packaging

- A-2 : ✓      • B-2 : ○

Diameter mm (in)	Spool		Basket		Coil					Pac				
	20kg (44lbs)	25kg (55lbs)	100kg (220lbs)	25kg (55lbs)	100kg (220lbs)	200kg (440lbs)	250kg (551lbs)	300kg (661lbs)	500kg (1102lbs)	200kg (440lbs)	250kg (551lbs)	300kg (661lbs)	350kg (771lbs)	400kg (881lbs)
1.6 (1/16)	✓													
2.0 (5/64)		✓		✓○	○							✓○	○	
2.4 (3/32)		✓○		✓○	○							○		
3.2 (1/8)		✓		✓○				✓				○		
4.0 (5/32)		✓		✓○	✓○	✓	✓		✓		✓	✓○	✓	✓

**Typical Chemical Composition of All-Weld Metal(%)**

Wire	C	Si	Mn	P	S	Cr	Mo	BM	Th.(mm)
A-2	0.05	0.68	0.75	0.020	0.010	-	0.46	SM570	25
B-2	0.05	0.68	0.75	0.020	0.010	1.06	0.44	A387-Gr11	25

**Typical Mechanical Properties of All-Weld Metal**

Wire	YS MPa(lbs/in <sup>2</sup> )	TS MPa(lbs/in <sup>2</sup> )	EL (%)	PWHT	Temp °C(°F)	CVN-Impact Value J (ft-lbs)	BM	Th.(mm)
A-2	580 (84,100)	640 (92,800)	28.0	As welded	-	-	SM570	25
B-2	630 (91,400)	720 (104,400)	20.8	As welded	0 (32)	32 (24)	A387-Gr.11	25
B-2	560 (81,200)	640 (92,800)	25.0	690°CX1hr	0 (32)	45 (33)	A387-Gr.11	25

**Typical Welding Conditions**

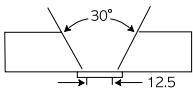
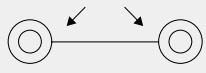
Wire	Dia. (mm)	Th. (mm)	Groove Design (mm)	Pass	Amp. (A)	Volt. (V)	Speed (cm/min)	Remarks
A-2 (B-2)	4.0	25		1-13	570	30	40	AWS A5.23
B-2	2.4	12		1	400	28	100	Fin tube of boiler

# S-777MXH X H-14

Type : Neutral

## Conformances

AWS A5.17/ ASME SFA5.17 F7A(P)2-EH14  
 JIS Z3183 S502-H  
 EN ISO 14174 S A AB 1 / EN ISO 14171 S4  
 KR 2T, 2YT, 3M, 3YM  
 ABS 2T, 2YT, 3M, 3YM  
 LR 3M, 3YM, 2T, 2YT

BV A2T, A2YT, A3M, A3YM  
 DNV I1YTH10, I1IYM H10  
 GL 2YT, 3YM  
 NK KAW3M, KAW53M  
 KAW2T, KAW52T  
 CWB CSA W48 F49A(P)3-EH14

## Applications

- LPG tanks
- General fabrication
- Structural fabrication

## Features

- Easy to remove slag
- High speed welding
- Horizontal and flat fillet welding
- Density : 1.2g/cm<sup>3</sup>

## Current

AC, DC +

## Basicity Index

0.9

## Packages (Flux)

Tin Can 20kg(44lbs)  
 PE Bag 20kg(44lbs)

## Flux Composition

Consumable	Chemical Composition, wt%		
	Al <sub>2</sub> O <sub>3</sub> + Fe <sub>2</sub> O <sub>3</sub>	MgO + MnO	SiO <sub>2</sub> + CaF <sub>2</sub>
S-777MXH	35	35	30

## Diameter / Packaging

Diameter mm (in)	Spool		Basket		Coil					Pac				
	20kg (44lbs)	25kg (55lbs)	100kg (220lbs)	25kg (55lbs)	100kg (220lbs)	200kg (440lbs)	250kg (551lbs)	300kg (661lbs)	500kg (1102lbs)	200kg (440lbs)	250kg (551lbs)	300kg (661lbs)	350kg (771lbs)	400kg (881lbs)
1.6 (1/16)	✓			✓							✓			✓
2.0 (5/64)	✓			✓	✓	✓	✓					✓		
2.4 (3/32)	✓	✓		✓	✓	✓								
3.2 (1/8)		✓		✓	✓	✓	✓	✓			✓	✓	✓	
4.0 (5/32)		✓		✓	✓	✓		✓	✓	✓	✓	✓	✓	✓
4.8 (3/16)	✓			✓	✓			✓	✓					
6.4 (1/4)				✓	✓									

**Typical Chemical Composition of All-Weld Metal(%)**

Wire	C	Si	Mn	P	S	BM	Th.(mm)
H-14	0.07	0.30	1.37	0.028	0.021	SS400	25
	0.12	0.30	1.43	0.024	0.012	SM490	20

**Typical Mechanical Properties of All-Weld Metal**

Wire	YS MPa(lbs/in <sup>2</sup> )	TS MPa(lbs/in <sup>2</sup> )	EL (%)	Temp °C(°F)	CVN-Impact Value J (ft.-lbs)	BM	Th.(mm)
H-14	520 (75,500)	570 (87,700)	30	-29 (-20)	120 (88)	SS400	25
	-	560 (81,300)	-	0 (32)	70 (52)	SM490	20

**Typical Welding Conditions**

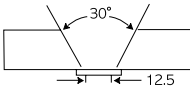
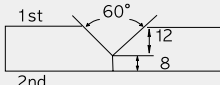
Wire	Dia. (mm)	Th. (mm)	Groove Design (mm)	Pass	Amp. (A)	Volt. (V)	Speed (cm/min)	Remarks
H-14	4.0	25		1-13	570	30	40	AWS A5.17
H-14	4.8	20		1st 2nd	800 850	34 36	25 25	Both Side Single-pass

SWAW

SAW

GM/AV

GTAW

FCAW

Non-FERROUS

APPENDIX

# S-777MXH X A-3

Type : Neutral

## Conformances

AWS A5.23/ ASME SFA5.23 F8A4-EA3-A3

JIS Z3183 S584-H

EN ISO 14174 S A AB 1 / EN ISO 14171 S4Mo

## Applications

- LPG tanks
- General fabrication
- Structural fabrication

## Features

- Easy to remove slag
- High speed welding
- Horizontal and flat fillet welding
- Density : 1.2g/cm<sup>3</sup>

## Current

AC, DC +

## Basicity Index

0.9

## Packages (Flux)

Tin Can 20kg(44lbs)

PE Bag 20kg(44lbs)

## Flux Composition

Consumable	Chemical Composition, wt%		
	Al <sub>2</sub> O <sub>3</sub> + Fe <sub>2</sub> O <sub>3</sub>	MgO + MnO	SiO <sub>2</sub> + CaF <sub>2</sub>
S-777MXH	35	35	30

## Diameter / Packaging

Diameter mm (in)	Spool		Basket		Coil					Pac				
	20kg (44lbs)	25kg (55lbs)	100kg (220lbs)	25kg (55lbs)	100kg (220lbs)	200kg (440lbs)	250kg (551lbs)	300kg (661lbs)	500kg (1102lbs)	200kg (440lbs)	250kg (551lbs)	300kg (661lbs)	350kg (771lbs)	400kg (881lbs)
1.6 (1/16)	✓													✓
2.0 (5/64)	✓			✓										
2.4 (3/32)				✓										
3.2 (1/8)				✓	✓			✓				✓		
4.0 (5/32)				✓	✓	✓		✓	✓		✓			
4.8 (3/16)				✓	✓			✓						



**Typical Chemical Composition of All-Weld Metal(%)**

Wire	C	Si	Mn	P	S	Mo	BM	Th.(mm)
A-3	0.04	0.28	1.30	0.025	0.015	0.50	SM570	25

**Typical Mechanical Properties of All-Weld Metal**

Wire	YS MPa(lbs/in <sup>2</sup> )	TS MPa(lbs/in <sup>2</sup> )	EL (%)	Temp °C(°F)	CVN-Impact Value J (ft-lbs)	BM	Th.(mm)
A-3	630 (91,500)	660 (95,900)	26	-40 (-40)	40 (30)	SM570	25
	-	640 (93,000)	-	-20 (-4)	70 (52)	API5Lx65	17.5

**Typical Welding Conditions**

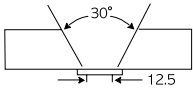
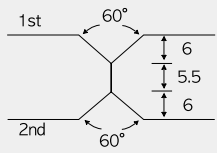
Wire	Dia. (mm)	Th. (mm)	Groove Design (mm)	Pass	Amp. (A)	Volt. (V)	Speed (cm/min)	Remarks
A-3	4.0	25		1~13	570	30	40	AWS A5.23
A-3	L(DC+):4.0	17.5		1st	(L)770 (T)640	32 40	110	Both Side Single-pass (tandem)
	T(AC):4.0			2nd	(L)1050 (T)750	32 42		

SWAW

SAW

GMAW

GTAW

FCAW

Non-FERROUS

APPENDIX

# S-727 X L-8(L-12)

Type : Active

## Conformances

AWS A5.17/ ASME SFA5.17 F7A2-EL8(EL12)  
 JIS Z3183 S502-H  
 EN ISO 14174 S A AB 1 / EN ISO 14171 S1  
 KR 2TM, 2YTM  
 ABS 2TM, 2YTM  
 2TM, 2YTM(Two-run tech : Max 5.0mm) (L-12)

LR 2TM, 2YTM  
 2YMH5 (L-12)  
 BV A2TM, A2YTM  
 DNV IYTM  
 GL 2YTM  
 NK KAW2TM, KAW52TM

## Applications

- Steel industry
- General fabrications

## Features

- Good resistance to porosity on rust, scales and primers
- Fillet welding of thin and medium plates
- Density : 1.2g/cm<sup>3</sup>

## Current

AC, DC +

## Basicity Index

1.1

## Packages (Flux)

Tin Can 20kg(44lbs)  
 PE Bag 20kg(44lbs)

## Flux Composition

Consumable	Chemical Composition, wt%			
	MgO + MnO	CaF <sub>2</sub> + CaO	Al <sub>2</sub> O <sub>3</sub> + SiO <sub>2</sub>	TiO <sub>2</sub> + FeO
S-727	20	10	50	15

## Diameter / Packaging

- L-8 : ✓
- L-12 : ○

Diameter	Spool		Basket		Coil					Pac				
	20kg (44lbs)	25kg (55lbs)	100kg (220lbs)	25kg (55lbs)	100kg (220lbs)	200kg (440lbs)	250kg (551lbs)	300kg (661lbs)	500kg (1102lbs)	200kg (440lbs)	250kg (551lbs)	300kg (661lbs)	350kg (771lbs)	400kg (881lbs)
1.6 (1/16)	✓													
2.0 (5/64)	✓	✓		○										
2.4 (3/32)				√○										
3.2 (1/8)				√○										
4.0 (5/32)				√○	✓									
4.8 (3/16)				✓	✓					✓	✓			
6.4 (1/4)										✓	✓			

**Typical Chemical Composition of All-Weld Metal(%)**

Wire	C	Si	Mn	P	S	BM	Th.(mm)
L-8	0.08	0.35	1.45	0.030	0.020	SS400	25

**Typical Mechanical Properties of All-Weld Metal**

Wire	YS MPa(lbs/in <sup>2</sup> )	TS MPa(lbs/in <sup>2</sup> )	EL (%)	Temp °C(°F)	CVN-Impact Value J (ft-lbs)	BM	Th.(mm)
L-8	480 (69,400)	560 (81,000)	30	-29 (-20)	50 (30)	SS400	25
	-	550 (79,900)	-	0 (32)	50 (30)	SM490A	28

**Typical Welding Conditions**

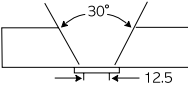
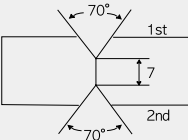
Wire	Dia. (mm)	Th. (mm)	Groove Design (mm)	Pass	Amp. (A)	Volt. (V)	Speed (cm/min)	Remarks
L-8	4.0	25		1~14	570	30	40	AWS A5.17
L-8	4.8	20		1st 2nd	880 970	34 35	28 33	Both side Single pass

SWAW

SAW

GMAW

GTAW

FCAW

Non-FERROUS

APPENDIX

# S-707 X L-8

Type : Active

## Conformances

AWS A5.17/ ASME SFA5.17 F7A4-EL8

JIS Z3183 S502-H

EN ISO 14174 S A AB 1 / EN ISO 14171 S1

KR 3TM, 3YTM

ABS 3TM, 3YTM

LR 3TM, 3YTM

BV A3TM, A3YTM

DNV IIIYTM

GL 3YTM

NK KAW3TM, KAW53TM

RS 3YTM

## Applications

- Shipbuilding

## Features

- Both side single-layer welding
- Low consumption of flux
- Density : 1.1g/cm<sup>3</sup>

## Current

AC, DC +

## Basicity Index

1.6

## Packages (Flux)

Tin Can 20kg(44lbs)

PE Bag 20kg(44lbs)

## Flux Composition

Consumable	Chemical Composition, wt%			
	SiO <sub>2</sub> + TiO <sub>2</sub>	CaO + MgO	Al <sub>2</sub> O <sub>3</sub> + MnO	CaF <sub>2</sub>
S-707	15	30	40	15

## Diameter / Packaging

Diameter	Spool		Basket		Coil					Pac				
	20kg (44lbs)	25kg (55lbs)	100kg (220lbs)	25kg (55lbs)	100kg (220lbs)	200kg (440lbs)	250kg (551lbs)	300kg (661lbs)	500kg (1102lbs)	200kg (440lbs)	250kg (551lbs)	300kg (661lbs)	350kg (771lbs)	400kg (881lbs)
1.6 (1/16)	✓													
2.0 (5/64)	✓	✓												
2.4 (3/32)				✓										
3.2 (1/8)				✓										
4.0 (5/32)				✓	✓									
4.8 (3/16)				✓	✓									
6.4 (1/4)								✓	✓					

**Typical Chemical Composition of All-Weld Metal(%)**

Wire	C	Si	Mn	P	S	BM	Th.(mm)
L-8	0.07	0.40	1.40	0.028	0.015	SS400	25
	0.08	0.32	1.29	0.015	0.014	AH36	25

**Typical Mechanical Properties of All-Weld Metal**

Wire	YS MPa(lbs/in <sup>2</sup> )	TS MPa(lbs/in <sup>2</sup> )	EL (%)	Temp °C(°F)	CVN-Impact Value J (ft.-lbs)	BM	Th.(mm)
L-8	490 (71,000)	560 (81,000)	31	-40 (-40)	70 (52)	SS400	25
	-	570 (82,800)	-	-20 (-4)	40 (30)	AH36	25

**Typical Welding Conditions**

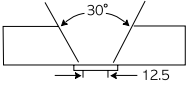
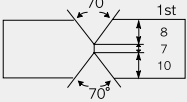
Wire	Dia. (mm)	Th. (mm)	Groove Design (mm)	Pass	Amp. (A)	Volt. (V)	Speed (cm/min)	Remarks
L-8	4.0	25		1-13	570	30	40	AWS A5.17
L-8	4.8	25		1st 2nd	950 1100	34 37	40 30	Both side Single pass

SWAW

SAW

GMAW

GTAW

FCAW

Non-FERROUS

APPENDIX

# S-737 X H-14

Type : Neutral

## Conformances

AWS A5.17/ ASME SFA5.17 F7A(P)4-EH14  
 JIS Z3183 S502-H  
 EN ISO 14174 S A AB 1 / EN ISO 14171 S4  
 KR 3M, 3YM

ABS 3M, 3YM  
 LR 3M, 3YM  
 DNV IIIYM  
 GL 3YM

## Applications

- Storage tanks
- Pressure vessels
- Shipbuilding

## Features

- Good performance and bead appearance
- Easy to remove slag
- Density : 1.1g/cm<sup>3</sup>

## Current

AC, DC +

## Basicity Index

1.6

## Packages (Flux)

Tin Can 20kg(44lbs)  
 PE Bag 20kg(44lbs)

## Flux Composition

Consumable	Chemical Composition, wt%			
	SiO <sub>2</sub> + TiO <sub>2</sub>	CaO + MgO	Al <sub>2</sub> O <sub>3</sub> + MnO	CaF <sub>2</sub>

## Diameter / Packaging

Diameter mm (in)	Spool	Basket			Coil					Pac				
	20kg (44lbs)	25kg (55lbs)	100kg (220lbs)	25kg (55lbs)	100kg (220lbs)	200kg (440lbs)	250kg (551lbs)	300kg (661lbs)	500kg (1102lbs)	200kg (440lbs)	250kg (551lbs)	300kg (661lbs)	350kg (771lbs)	400kg (881lbs)
1.6 (1/16)	✓			✓							✓			✓
2.0 (5/64)	✓			✓	✓	✓	✓					✓		
2.4 (3/32)	✓	✓		✓	✓	✓								
3.2 (1/8)		✓		✓	✓	✓	✓	✓			✓	✓	✓	
4.0 (5/32)		✓		✓	✓	✓		✓	✓	✓	✓	✓	✓	✓
4.8 (3/16)	✓			✓	✓			✓	✓					
6.4 (1/4)				✓	✓									

**Typical Chemical Composition of All-Weld Metal(%)**

Wire	C	Si	Mn	P	S	BM	Th.(mm)
H-14	0.08	0.31	1.60	0.025	0.019	SS400	25
	0.07	0.40	1.53	0.020	0.013	SM490	28

**Typical Mechanical Properties of All-Weld Metal**

Wire	YS MPa(lbs/in <sup>2</sup> )	TS MPa(lbs/in <sup>2</sup> )	EL (%)	Temp °C(°F)	CVN-Impact Value J (ft.-lbs)	BM	Th.(mm)
H-14	510 (74,000)	570 (82,800)	31	-40 (-40)	110 (81)	SS400	25
	-	540 (78,400)	-	-20 (-4)	60 (44)	SM490	28

**Typical Welding Conditions**

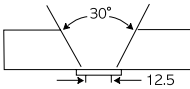
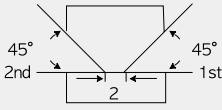
Wire	Dia. (mm)	Th. (mm)	Groove Design (mm)	Pass	Amp. (A)	Volt. (V)	Speed (cm/min)	Remarks
H-14	4.0	25		1-13	570	30	40	AW A5.17
H-14	3.2	28		1	450	28	35	1st
				2-4	500	26	50	
				5	450	28	35	Horizontal ML
				6-8	500	26	50	

SWAW

SAW

GM/AV

GTAW

FCAW

Non-FERROUS

APPENDIX

# S-717 X M-12K

Type : Neutral



## Conformances

AWS A5.17/ ASME SFA5.17 F7A(P)6-EM12K

JIS Z3183 S502-H

EN ISO 14174 S A AB 1 / EN ISO 14171 S2Si

KR 3M, 3YM

ABS 3M, 3YM

LR 3YM

BV A3, A3YM

DNV IIIYM

GL 3YM

NK KAW53M

RS 3YM

CWB CSA W48 F49A(P)5-EM12K

TÜV EN ISO 14174 - S A AB 1

EN ISO 14171-A - S2Si

CE

DB DIN EN 760-S A AB1

DIN EN ISO 14171-A-S2Si

## Applications

- Pressure vessels
- Windtower
- Structural steels

## Features

- Good performance with thick plates
- Good resistance to crack
- Density : 1.1g/cm<sup>3</sup>

## Current

AC, DC +

## Basicity Index

1.9

## Packages (Flux)

Tin Can 20kg(44lbs)

PE Bag 20kg(44lbs)

## Flux Composition

Consumable	Chemical Composition, wt%			
	SiO <sub>2</sub> + TiO <sub>2</sub>	Al <sub>2</sub> O <sub>3</sub> + MnO	CaO + MgO	CaF <sub>2</sub>
S-717	10	30	35	10

## Diameter / Packaging

Diameter mm (in)	Spool			Basket						Coil					Pac				
	20kg (44lbs)	25kg (55lbs)	100kg (220lbs)	25kg (55lbs)	100kg (220lbs)	200kg (440lbs)	250kg (551lbs)	300kg (661lbs)	500kg (1102lbs)	200kg (440lbs)	250kg (551lbs)	300kg (661lbs)	350kg (771lbs)	400kg (881lbs)					
1.6 (1/16)	✓			✓									✓						
2.0 (5/64)	✓			✓							✓		✓	✓					
2.4 (3/32)		✓	✓	✓	✓									✓					
3.2 (1/8)		✓	✓	✓	✓					✓				✓					
4.0 (5/32)		✓	✓	✓	✓	✓				✓	✓	✓		✓					
4.8 (3/16)				✓	✓				✓	✓	✓								



**Typical Chemical Composition of All-Weld Metal(%)**

Wire	C	Si	Mn	P	S	BM	Th.(mm)
M-12K	0.09	0.26	1.40	0.023	0.004	SS400	25
	0.08	0.54	1.47	0.025	0.018	BS4360-Gr,50D	44

**Typical Mechanical Properties of All-Weld Metal**

Wire	YS MPa(lbs/in <sup>2</sup> )	TS MPa(lbs/in <sup>2</sup> )	EL (%)	Temp °C(°F)	CVN-Impact Value J (ft-lbs)	BM	Th.(mm)
M-12K	555 (80,500)	614 (89,100)	29	-51 (-60)	60 (44)	SS400	25
	510 (74,000)	580 (84,200)	28	-20 (-4)	70 (52)	BS4360-Gr,50D	44

**Typical Welding Conditions**

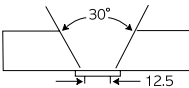
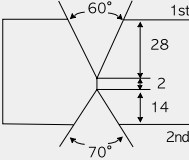
Wire	Dia. (mm)	Th. (mm)	Groove Design (mm)	Pass	Amp. (A)	Volt. (V)	Speed (cm/min)	Remarks
M-12K	4.0	25		1-13	570	30	40	AWS A5.17
M-12K	4.0	44		1	500	32	40	1st
				2-14	600	36	50	
				15 16-23	500 600	32 36	40 50	2nd
					Back Gouging			ML

SWAW

SAW

GM/AV

GTAW

FCAW

Non-FERROUS

APPENDIX

# S-707T X H-14

Type : Neutral



## Conformances

AWS A5.17/ ASME SFA5.17 F7A(P)6-EH14  
 JIS Z3183 S502-H  
 EN ISO 14174 S A AB 1 / EN ISO 14171 S4  
 KR 3T, 3YT, 4YM  
 ABS 4YM, 3T, 3YT  
 LR 4YM, 3T, 3YT

BV A4YM, A3T, A3YT  
 DNV IVYM, IIIYT  
 GL 4YM, 3YT  
 NK KAW53T, KAW54M  
 RS 3T, 3YT, 4Y40T, 4Y40M H10  
 CE

## Applications

- Shipbuilding

## Features

- Both side single-layer welding
- Low consumption of flux
- Density : 1.2g/cm<sup>3</sup>

## Current

AC, DC +

## Basicity Index

1.5

## Packages (Flux)

Tin Can 20kg(44lbs)  
 PE Bag 20kg(44lbs)

## Flux Composition

Consumable	Chemical Composition, wt%		
	SiO <sub>2</sub> + Al <sub>2</sub> O <sub>3</sub>	MgO + CaF <sub>2</sub> + CaO	MnO + FeO
S-707T	50	45	5

## Diameter / Packaging

Diameter mm (in)	Spool		Basket		Coil					Pac				
	20kg (44lbs)	25kg (55lbs)	100kg (220lbs)	25kg (55lbs)	100kg (220lbs)	200kg (440lbs)	250kg (551lbs)	300kg (661lbs)	500kg (1102lbs)	200kg (440lbs)	250kg (551lbs)	300kg (661lbs)	350kg (771lbs)	400kg (881lbs)
1.6 (1/16)	✓			✓							✓			✓
2.0 (5/64)	✓			✓	✓	✓	✓					✓		
2.4 (3/32)	✓	✓		✓	✓	✓								
3.2 (1/8)		✓		✓	✓	✓	✓	✓			✓	✓	✓	
4.0 (5/32)		✓		✓	✓	✓		✓	✓	✓	✓	✓	✓	✓
4.8 (3/16)	✓			✓	✓			✓	✓					
6.4 (1/4)				✓	✓									

**Typical Chemical Composition of All-Weld Metal(%)**

Wire	C	Si	Mn	P	S	BM	Th.(mm)
H-14	0.10	0.37	1.54	0.020	0.012	SS400	25
	0.14	0.41	1.43	0.018	0.008	EH36	20
	0.11	0.29	1.52	0.018	0.009	DH36	25

**Typical Mechanical Properties of All-Weld Metal**

Wire	YS MPa(lbs/in <sup>2</sup> )	TS MPa(lbs/in <sup>2</sup> )	EL (%)	Position of fracture	CVN-Impact Value J (ft·lbs)			BM	Th.(mm)
					0°C (32°F)	-20°C (-4°F)	-51°C (-60°F)		
H-14	570 (82,800)	605 (87,900)	28.0	-	-	-	80 (59)	SS400	25
	-	570 (82,800)	-	BM	-	50 (37)	-	EH36	20
	-	580 (84,200)	23.0	-	70 (52)	-	-	DH36	25

**Typical Welding Conditions**

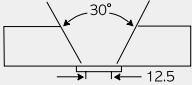
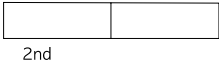
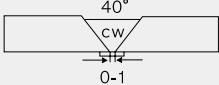
Wire	Dia. (mm)	Th. (mm)	Groove Design (mm)	Pass	Amp. (A)	Volt. (V)	Speed (cm/min)	Remarks
H-14	4.0	25		1-13	550	30	40	AWS A5.17
H-14	4.8	20		1st	L(DC+) 1100 T(AC) 700	37 42	100	Tandem
				2nd	L(DC+) 1200 T(AC) 700	37 42		
H-14	4.8	25		1	1150	35	20	FAB OSW (DC+)

# S-707TP X H-14

Type : Neutral

## Conformances

AWS A5.17/ ASME SFA5.17 F7A(P)6-EH14  
 JIS Z3183 S502-H  
 EN ISO 14174 S A AB 1 / EN ISO 14171 S4  
 KR 3M, 3YM  
 ABS 3M, 3YM

LR 3M, 3YM  
 BV A3M, A3YM  
 DNV IIIYM  
 GL 3YM  
 NK KAW3M, KAW53M

## Applications

- Shipbuilding
- Machinery
- Pressure vessels

## Features

- Good mechanical properties with multi-layer welding
- Good bead appearance in low speed welding with high currents
- Density : 1.2g/cm<sup>3</sup>

## Current

AC, DC +

## Basicity Index

1.8

## Packages (Flux)

Tin Can 20kg(44lbs)  
 PE Bag 20kg(44lbs)

## Flux Composition

Consumable	Chemical Composition, wt%			
	SiO <sub>2</sub> + TiO <sub>2</sub>	CaO + MgO	Al <sub>2</sub> O <sub>3</sub> + MnO	CaF <sub>2</sub>
S-707TP	20	35	30	15

## Diameter / Packaging

Diameter mm (in)	Spool			Basket						Coil				Pac				
	20kg (44lbs)	25kg (55lbs)	100kg (220lbs)	25kg (55lbs)	100kg (220lbs)	200kg (440lbs)	250kg (551lbs)	300kg (661lbs)	500kg (1102lbs)	200kg (440lbs)	250kg (551lbs)	300kg (661lbs)	350kg (771lbs)	400kg (881lbs)				
1.6 (1/16)	✓			✓							✓			✓				
2.0 (5/64)	✓			✓	✓	✓	✓					✓						
2.4 (3/32)	✓	✓		✓	✓	✓												
3.2 (1/8)		✓		✓	✓	✓	✓	✓			✓	✓	✓					
4.0 (5/32)		✓		✓	✓	✓		✓	✓	✓	✓	✓	✓	✓				
4.8 (3/16)	✓			✓	✓			✓	✓									
6.4 (1/4)				✓	✓													

**Typical Chemical Composition of All-Weld Metal(%)**

Wire	C	Si	Mn	P	S	BM	Th.(mm)
H-14	0.09	0.25	1.40	0.020	0.016	SS400	25
	0.11	0.29	1.60	0.022	0.014	EH36	32

**Typical Mechanical Properties of All-Weld Metal**

Wire	YS MPa(lbs/in <sup>2</sup> )	TS MPa(lbs/in <sup>2</sup> )	EL (%)	Temp °C(°F)	CVN-Impact Value J (ft.-lbs)	BM	Th.(mm)
H-14	510 (74,000)	570 (82,800)	28	-51 (-60)	80 (59)	SS400	25
	550 (76,800)	590 (85,700)	-	-40 (-40)	60 (44)	EH36	32

**Typical Welding Conditions**

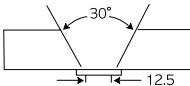
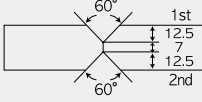
Wire	Dia. (mm)	Th. (mm)	Groove Design (mm)	Pass	Amp. (A)	Volt. (V)	Speed (cm/min)	Remarks
H-14	4.0	25		1-13	570	30	40	AWS A5.17
H-14	4.8	32		1	200	28	20	(FCAW)
				2	280	32	25	(FCAW)
				3	600	32	35	Both
				4-8	700	34	40	Multi-
				9~	800	36	40	pass

SWAW

SAW

GM/AV

GTAW

FCAW

Non-FERROUS

APPENDIX

# S-787TB X H-14

Type : Neutral



## Conformances

AWS A5.17/ ASME SFA5.17 F7A(P)8-EH14  
 JIS Z3352 S A FB 1  
 EN ISO 14174 S A FB 1 / EN ISO 14171 S4  
 KR 3T, 3YT, 4Y40M (-60°C ≥41 J)  
 ABS 3T, 3YT, 5Y400M  
 LR 3YT, 5Y40M  
 BV A5Y40M, A3T, A3YT

DNV VY40M H10, IIIYT (35t),  
 VYT (20t)  
 GL 6Y40M, 3YT  
 NK KAWL3TM, KAW54Y40M  
 CWB CSA W48 F49A(P)6-EH14  
 CE

## Applications

- Offshore structure
- Pressure vessels
- Cryogenic applications

## Features

- Good impact value at low temperature
- Good resistance to pockmark and porosity
- Density : 1.2g/cm<sup>3</sup>

## Current

AC, DC +

## Basicity Index

2.4

## Packages (Flux)

Tin Can 20kg(44lbs)  
 PE Bag 20kg(44lbs)

## Flux Composition

Consumable	Chemical Composition, wt%			
	SiO <sub>2</sub> + TiO <sub>2</sub>	CaO + MgO	Al <sub>2</sub> O <sub>3</sub> + MnO	CaF <sub>2</sub>
S-787TB	15	55	15	15

## Diameter / Packaging

Diameter mm (in)	Spool		Basket		Coil					Pac				
	20kg (44lbs)	25kg (55lbs)	100kg (220lbs)	25kg (55lbs)	100kg (220lbs)	200kg (440lbs)	250kg (551lbs)	300kg (661lbs)	500kg (1102lbs)	200kg (440lbs)	250kg (551lbs)	300kg (661lbs)	350kg (771lbs)	400kg (881lbs)
1.6 (1/16)	✓			✓							✓			✓
2.0 (5/64)	✓			✓	✓	✓	✓					✓		
2.4 (3/32)	✓	✓		✓	✓	✓								
3.2 (1/8)		✓		✓	✓	✓	✓	✓			✓	✓	✓	
4.0 (5/32)		✓		✓	✓	✓		✓	✓	✓	✓	✓	✓	✓
4.8 (3/16)	✓			✓	✓			✓	✓					
6.4 (1/4)				✓	✓									

**Typical Chemical Composition of All-Weld Metal(%)**

Wire	C	Si	Mn	P	S	Ti	B	BM	Th.(mm)
H-14	0.09	0.25	1.53	0.020	0.015	0.020	0.0020	SS400	25
	0.06	0.12	1.12	0.012	0.005	0.021	0.0024	API-2HGr.50	80

**Typical Mechanical Properties of All-Weld Metal**

Wire	YS MPa(lbs/in <sup>2</sup> )	TS MPa(lbs/in <sup>2</sup> )	EL (%)	Temp °C(°F)	CVN-Impact Value J (ft.-lbs)	BM	Th.(mm)
H-14	580 (84,200)	620 (90,000)	31	-62 (-80)	90 (66)	SS400	25
	470 (68,200)	550 (76,800)	34	-40 (-40)	90 (66)	API-2H Gr.50	80
				-62 (-80)	70 (52)		

**Typical Welding Conditions**

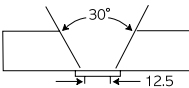
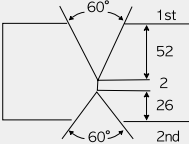
Wire	Dia. (mm)	Th. (mm)	Groove Design (mm)	Pass	Amp. (A)	Volt. (V)	Speed (cm/min)	Remarks
H-14	4.0	25		1-13	570	30	40	AWS A5.17
H-14	4.0	80		1	220	26	55	(FCAW)
				2	450	28	30	1st
				3-25	600	34	30	
				26	450	28	30	2nd
				27-36	600	34	30	Back Gouging

# Superflux55ULT X H-14

Type : Neutral



## Conformances

AWS A5.17/ ASME SFA5.17 F7A(P)8-EH14  
 JIS Z3183 S502-H  
 EN ISO 14174 S A FB 1 / EN ISO 14171 S4  
 KR 4Y40M H5 (-60°C ≥41 J)  
 ABS 5Y400MH5, 4YT  
 LR 4YT, 4Y40M H5  
 BV A5Y40M HHH, A4YT  
 DNV VY40MH5, IVYT / VYT (T:t≤20mm)

GL 6Y40H5M, 4YT  
 NK KAW54T, KAW54Y40MH5  
 (-60°C ≥41 J)  
 TÜV EN ISO 14174 - S A FB 1  
 EN ISO 14171-A - S4  
 RS 5YT, 4Y40T, 5Y40M H5  
 CE  
 DB DIN EN 760-S A FB1  
 DIN EN ISO 14171-A-S4

## Applications

- Offshore
- Shipbuilding
- Cryogenic applications

## Features

- Good impact value and CTOD at low temperature
- Low hydrogen content
- Tandem, multi-electrode applicable
- Density : 1.2g/cm<sup>3</sup>

## Current

AC, DC +

## Basicity Index

2.5

## Packages (Flux)

Tin Can 20kg(44lbs)  
 PE Bag 20kg(44lbs)

## Flux Composition

Consumable	Chemical Composition, wt%			
	SiO <sub>2</sub> + TiO <sub>2</sub>	CaO + MgO	Al <sub>2</sub> O <sub>3</sub> + MnO	CaF <sub>2</sub>
Superflux55ULT	20	40	20	15

## Diameter / Packaging

Diameter mm (in)	Spool			Basket						Coil				Pac				
	20kg (44lbs)	25kg (55lbs)	100kg (220lbs)	25kg (55lbs)	100kg (220lbs)	200kg (440lbs)	250kg (551lbs)	300kg (661lbs)	500kg (1102lbs)	200kg (440lbs)	250kg (551lbs)	300kg (661lbs)	350kg (771lbs)	400kg (881lbs)				
1.6 (1/16)	✓			✓							✓			✓				
2.0 (5/64)	✓			✓	✓	✓	✓					✓						
2.4 (3/32)	✓	✓		✓	✓	✓												
3.2 (1/8)		✓		✓	✓	✓	✓	✓				✓	✓	✓				
4.0 (5/32)		✓		✓	✓	✓		✓	✓	✓	✓	✓	✓	✓				
4.8 (3/16)	✓			✓	✓			✓	✓									
6.4 (1/4)				✓	✓													



Typical Chemical Composition of All-Weld Metal(%)

Wire	C	Si	Mn	P	S	Ti	B	BM	Th.(mm)
H-14	0.09	0.21	1.34	0.019	0.012	0.018	0.0015	SS400	25
	0.08	0.26	1.40	0.020	0.009	0.020	0.0018	EH36-TM	83

Typical Mechanical Properties of All-Weld Metal

Wire	YS MPa(lbs/in <sup>2</sup> )	TS MPa(lbs/in <sup>2</sup> )	EL (%)	Position of fracture	CVN-Impact Value J (ft.lbs)		BM	Th.(mm)
					-40°C (-40°F)	-62°C (-80°F)		
H-14	530 (76,900)	580 (84,200)	30	-	-	120 (88)	SS400	25
	510 (74,000)	570 (82,800)	32	-	150 (110)	110 (81)	EH36-TM	83

Typical Welding Conditions

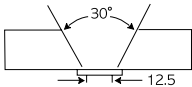
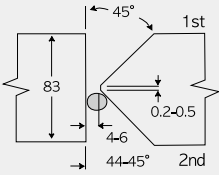
Wire	Dia. (mm)	Th. (mm)	Groove Design (mm)	Pass	Amp. (A)	Volt. (V)	Speed (cm/min)	Remarks			
H-14	4.0	25		1-13	570	30	40	AWS A5.17			
H-14	4.8	83		1	220	25	21	(FCAW)			
				2	270	30	25	(FCAW)			
				3	550	30	35	Both Side Multi-pass			
				4-27	650	34	40				
								Back Gouging			
				28	550	30	35				
29-51	650	34	40								

# Superflux787 X H-12K

Type : Neutral

## Conformances

AWS A5.17/ ASME SFA5.17 F7A(P)8-EH12K  
 JIS Z3183 S502-H  
 EN ISO 14174 S A FB 1 / EN ISO 14171 S3Si

## Applications

- Offshore
- Pressure vessels
- Pipeline

## Features

- Low hydrogen content
- Tandem, multi-electrode applicable
- Good impact value at low temperature after heat treatment
- Density : 1.2g/cm<sup>3</sup>

## Current

AC, DC +

## Basicity Index

2.5

## Packages (Flux)

Tin Can 20kg(44lbs)  
 PE Bag 20kg(44lbs)

## Flux Composition

Consumable	Chemical Composition, wt%		
	MgO + MnO	CaF <sub>2</sub> + CaO	Al <sub>2</sub> O <sub>3</sub> + SiO <sub>2</sub>
Superflux787	35	35	30

## Diameter / Packaging

Diameter	Spool		Basket		Coil					Pac				
	20kg (44lbs)	25kg (55lbs)	100kg (220lbs)	25kg (55lbs)	100kg (220lbs)	200kg (440lbs)	250kg (551lbs)	300kg (661lbs)	500kg (1102lbs)	200kg (440lbs)	250kg (551lbs)	300kg (661lbs)	350kg (771lbs)	400kg (881lbs)
1.6 (1/16)	✓													
2.4 (3/32)				✓										
3.2 (1/8)				✓	✓	✓								
4.0 (5/32)				✓	✓	✓		✓	✓		✓	✓	✓	✓

**Typical Chemical Composition of All-Weld Metal(%)**

Wire	C	Si	Mn	P	S	BM	Th.(mm)
H-12K	0.09	0.30	1.50	0.018	0.010	AH36	25

**Typical Mechanical Properties of All-Weld Metal**

Wire	YS MPa(lbs/in <sup>2</sup> )	TS MPa(lbs/in <sup>2</sup> )	EL (%)	PWHT condition	Temp °C(°F)	CVN-Impact Value J (ft.-lbs)	BM	Th.(mm)
H-12K	540 (78,400)	580 (84,200)	32.0	-	-62 (-80)	101 (75)	AH36	25
	450 (45,300)	520 (75,500)	33.0	620°C×1hr	-62 (-80)	110 (81)	AH36	25

**Typical Welding Conditions**

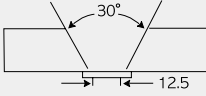
Wire	Dia. (mm)	Th. (mm)	Groove Design (mm)	Pass	Amp. (A)	Volt. (V)	Speed (cm/min)	Remarks
H-12K	4.0	25		1-13	570	30	40	AWS A5.17

SMW

SAW

GMAW

GTAW

FCAW

Non-FERROUS

APPENDIX

# Superflux787 X H-14

Type : Neutral

## Conformances

AWS A5.17/ ASME SFA5.17 F7A(P)8-EH14  
 JIS Z3183 S502-H  
 EN ISO 14174 S A FB 1 / EN ISO 14171 S4  
 KR 4YM  
 ABS 3M, 4YM  
 LR 3M, 4YM

BV A4YM  
 DNV IVYM  
 GL 4YM  
 NK KAW54M  
 CCS 4YM

## Applications

- Offshore
- Pressure vessels
- Pipeline

## Features

- Low hydrogen content
- Tandem, multi-electrode applicable
- Good impact value at low temperature after heat treatment
- Density : 1.2g/cm<sup>3</sup>

## Current

AC, DC +

## Basicity Index

2.5

## Packages (Flux)

Tin Can 20kg(44lbs)  
 PE Bag 20kg(44lbs)

## Flux Composition

Consumable	Chemical Composition, wt%		
	MgO + MnO	CaF <sub>2</sub> + CaO	Al <sub>2</sub> O <sub>3</sub> + SiO <sub>2</sub>
Superflux787	35	35	30

## Diameter / Packaging

Diameter mm (in)	Spool		Basket		Coil					Pac				
	20kg (44lbs)	25kg (55lbs)	100kg (220lbs)	25kg (55lbs)	100kg (220lbs)	200kg (440lbs)	250kg (551lbs)	300kg (661lbs)	500kg (1102lbs)	200kg (440lbs)	250kg (551lbs)	300kg (661lbs)	350kg (771lbs)	400kg (881lbs)
1.6 (1/16)	✓			✓							✓			✓
2.0 (5/64)	✓			✓	✓	✓	✓					✓		
2.4 (3/32)	✓	✓		✓	✓	✓								
3.2 (1/8)		✓		✓	✓	✓	✓	✓			✓	✓	✓	
4.0 (5/32)		✓		✓	✓	✓		✓	✓	✓	✓	✓	✓	✓
4.8 (3/16)	✓			✓	✓			✓	✓					
6.4 (1/4)				✓	✓									

**Typical Chemical Composition of All-Weld Metal(%)**

Wire	C	Si	Mn	P	S	BM	Th.(mm)
H-14	0.10	0.07	1.43	0.018	0.010	SS400	25
	0.06	0.13	1.37	0.016	0.007	SM490	39

**Typical Mechanical Properties of All-Weld Metal**

Wire	YS MPa(lbs/in <sup>2</sup> )	TS MPa(lbs/in <sup>2</sup> )	EL (%)	Temp °C(°F)	CVN-Impact Value J (ft-lbs)	BM	Th.(mm)
H-14	470 (68,200)	560 (81,300)	26	-62 (-80)	130 (96)	SS400	25
	-	550 (76,800)	-	-40 (-40)	80 (59)	SM490	39
	-	-	-	-62 (-80)	50 (37)		

**Typical Welding Conditions**

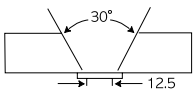
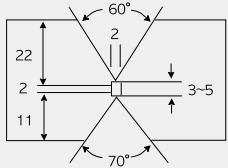
Wire	Dia. (mm)	Th. (mm)	Groove Design (mm)	Pass	Amp. (A)	Volt. (V)	Speed (cm/min)	Remarks
H-14	4.0	25		1-13	570	30	40	AWS A5.17
H-14	4.0	39		1	500	28	35	1st
				2-7	600	32	30	
				Back Gouging				8
9-13	600	32	30					

# S-787TT X H-12K(H-14)

Type : Neutral

## Conformances

AWS A5.17/ ASME SFA5.17 F7A(P)8-EH12K  
 AWS A5.17/ ASME SFA5.17 F7A(P)8-EH14  
 JIS Z3183 S502-H  
 EN ISO 14174 S A AB 1 / EN ISO 14171 S3Si[S4]

## Applications

- Shipbuilding
- Offshore
- Pipeline

## Features

- Single and multi electrode welding applicable
- Good impact value at low temperature
- Density : 1.2g/cm<sup>3</sup>

## Current

AC, DC +

## Basicity Index

2.4

## Packages (Flux)

Tin Can 20kg(44lbs)  
 PE Bag 20kg(44lbs)

## Flux Composition

Consumable	Chemical Composition, wt%			
	SiO <sub>2</sub> + TiO <sub>2</sub>	CaO + MgO	Al <sub>2</sub> O <sub>3</sub> + MnO	CaF <sub>2</sub>
S-787TT	20	50	15	15

## Diameter / Packaging

- H-12K : √      • H-14 : ○

Diameter	Spool		Basket		Coil					Pac				
	20kg (44lbs)	25kg (55lbs)	100kg (220lbs)	25kg (55lbs)	100kg (220lbs)	200kg (440lbs)	250kg (551lbs)	300kg (661lbs)	500kg (1102lbs)	200kg (440lbs)	250kg (551lbs)	300kg (661lbs)	350kg (771lbs)	400kg (881lbs)
1.6 (1/16)	√○			○							○			○
2.0 (5/64)	○			○	○	○	○					○		
2.4 (3/32)	○	○		√○	○	○								
3.2 (1/8)		○		√○	√○	√○	○				○	○	○	
4.0 (5/32)		○		√○	√○	√○		√○	√○	○	√○	√○	√○	√○
4.8 (3/16)	○			○	○			○	○					
6.4 (1/4)				○	○									

Typical Chemical Composition of All-Weld Metal(%)

Wire	C	Si	Mn	P	S	BM	Th.(mm)
H-12K	0.10	0.31	1.33	0.019	0.007	SS400	25
H-12K	0.09	0.28	1.46	0.013	0.016	API 2H Gr.50	25.4
H-14	0.10	0.11	1.41	0.019	0.005	SS400	25

Typical Mechanical Properties of All-Weld Metal

Wire	YS MPa(lbs/in <sup>2</sup> )	TS MPa(lbs/in <sup>2</sup> )	EL (%)	Position of fracture	CVN-Impact Value J (ft-lbs)		BM	Th.(mm)
					-50°C (-58°F)	-62°C (-80°F)		
H-12K	510 (74,000)	590 (85,600)	26	-	-	100 (74)	SS400	25
H-12K	-	560 (81,200)	-	BM	110 (81)	-	API 2H Gr.50	25.4
H-14	521 (75,600)	550 (79,800)	29	-	-	120 (89)	SS400	25

Typical Welding Conditions

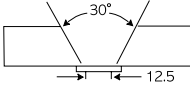
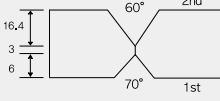
Wire	Dia. (mm)	Th. (mm)	Groove Design (mm)	Pass	Amp. (A)	Volt. (V)	Speed (cm/min)	Remarks
H-12K (H-14)	4.0	25		1~13	570	30	40	AWS A5.17
H-12K	L(DC+):4.0 T(AC):4.0	25.4		1st 1 2 2nd 3-4	(L)580 (T)500 (L)750 (T)550 (L)700 (T)550	32 32 34 32 34	60 50 60	Both Side Multi- pass

# Superflux55LP X H-14

Type : Neutral

## Conformances

AWS A5.17/ ASME SFA5.17 F7A(P)8-EH14  
 JIS Z3183 S502-H  
 EN ISO 14174 S A AB 1 / EN ISO 14171 S4  
 ABS 5Y400M H10

LR 4Y40M H10  
 BV A5Y40M HH  
 DNV VY40M H10  
 GL 6Y40M H10

## Applications

- Shipbuilding
- Offshore structure

## Features

- Good impact value and CTOD at low temperature
- Density : 1.2g/cm<sup>3</sup>

## Current

AC, DC +

## Basicity Index

2.5

## Packages (Flux)

Tin Can 20kg(44lbs)  
 PE Bag 20kg(44lbs)

## Flux Composition

Consumable	Chemical Composition, wt%			
	SiO <sub>2</sub> + TiO <sub>2</sub>	CaO + MgO	Al <sub>2</sub> O <sub>3</sub> + MnO	CaF <sub>2</sub>
Superflux55LP	20	45	20	10

## Diameter / Packaging

Diameter mm (in)	Spool			Basket						Coil				Pac				
	20kg (44lbs)	25kg (55lbs)	100kg (220lbs)	25kg (55lbs)	100kg (220lbs)	200kg (440lbs)	250kg (551lbs)	300kg (661lbs)	500kg (1102lbs)	200kg (440lbs)	250kg (551lbs)	300kg (661lbs)	350kg (771lbs)	400kg (881lbs)				
1.6 (1/16)	✓			✓							✓			✓				
2.0 (5/64)	✓			✓	✓	✓	✓					✓						
2.4 (3/32)	✓	✓		✓	✓	✓												
3.2 (1/8)		✓		✓	✓	✓	✓	✓			✓	✓	✓					
4.0 (5/32)		✓		✓	✓	✓		✓	✓	✓	✓	✓	✓	✓				
4.8 (3/16)	✓			✓	✓			✓	✓									
6.4 (1/4)				✓	✓													



**Typical Chemical Composition of All-Weld Metal(%)**

Wire	C	Si	Mn	P	S	Mo	BM	Th.(mm)
H-14	0.10	0.15	1.45	0.020	0.005	-	SS400	25

**Typical Mechanical Properties of All-Weld Metal**

Wire	YS MPa(lbs/in <sup>2</sup> )	TS MPa(lbs/in <sup>2</sup> )	EL (%)	Position of fracture	CVN-Impact Value J (ft·lbs)			BM	Th.(mm)
					-51°C (-60°F)	-55°C (-67°F)	-62°C (-80°F)		
H-14	495 (71,800)	560 (81,200)	29	-	-	-	150 (110)	SS400	25

**Typical Welding Conditions**

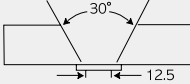
Wire	Dia. (mm)	Th. (mm)	Groove Design (mm)	Pass	Amp. (A)	Volt. (V)	Speed (cm/min)	Remarks
H-14	4.0	25		1-13	570	30	40	AWS A5.17

SWAW

SAW

GMAW

GTAW

FCAW

Non-FERROUS

APPENDIX

# Superflux800T X M-12K(A-2)

Type : Neutral



## Conformances

AWS A5.17 / ASME SFA5.17 F7A8-EM12K

AWS A5.23 / ASME SFA5.23 F8A4-EA2-A3

EN ISO 14174 S A AB 1 / EN ISO 14171 S2Si[S2Mo]

TÜV EN ISO 14174 - S A FB 1 / EN ISO 14171-A - S2Si

EN 756 - S2 Mo

CE

DB DIN EN 760-S A FB1

DIN EN ISO 14171-A-S2Si (M-12K)

DIN EN ISO 14171-A-S2Mo (A-2)

## Applications

- Windtower
- Power plant

## Features

- Good bead appearance
- Easy to remove slag
- Low consumption of flux
- Density : 1.1g/cm<sup>3</sup>

## Current

AC, DC +

## Basicity Index

2.4

## Packages (Flux)

Tin Can 20kg(44lbs)

PE Bag 20kg(44lbs)

## Flux Composition

Consumable	Chemical Composition, wt%			
	SiO <sub>2</sub> + TiO <sub>2</sub>	Al <sub>2</sub> O <sub>3</sub> + MnO	CaO + MgO	CaF <sub>2</sub>
Superflux800T	10	30	40	15

## Diameter / Packaging

- M-12K : √    • A-2 : ○

Diameter mm (in)	Spool		Basket		Coil					Pac				
	20kg (44lbs)	25kg (55lbs)	100kg (220lbs)	25kg (55lbs)	100kg (220lbs)	200kg (440lbs)	250kg (551lbs)	300kg (661lbs)	500kg (1102lbs)	200kg (440lbs)	250kg (551lbs)	300kg (661lbs)	350kg (771lbs)	400kg (881lbs)
1.6 (1/16)	√○			√									√	
2.0 (5/64)	√	○		√○							√	○	√	√
2.4 (3/32)		√○	√	√○	√									√
3.2 (1/8)		√○	√	√○	√			○		√				√
4.0 (5/32)		√○	√	√○	√○	√○	○		√○	√	√○	√○	○	√○
4.8 (3/16)				√	√			√	√	√				

Typical Chemical Composition of All-Weld Metal(%)

Wire	C	Si	Mn	P	S	Mo	BM	Th.(mm)
M-12K	0.09	0.35	1.40	0.023	0.006	-	SM490	25
A-2	0.09	0.24	1.48	0.020	0.006	0.43	SM570	25
M-12K	0.10	0.35	1.40	0.020	0.007	-	S355NL	45

Typical Mechanical Properties of All-Weld Metal

Wire	YS MPa(lbs/in <sup>2</sup> )	TS MPa(lbs/in <sup>2</sup> )	EL (%)	Position of fracture	CVN-Impact Value J (ft-lbs)			BM	Th. (mm)
					-40°C (-40°F)	-50°C (-58°F)	-60°C (-76°F)		
M-12K	530 (76,700)	570 (82,700)	29	-	-	-	100 (74)	SM490	25
A-2	630 (91,400)	660 (95,700)	24	-	70 (52)	-	-	SM570	25
M-12K	-	550 (79,800)	-	BM	-	60 (44)	-	S355NL	45

Typical Welding Conditions

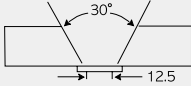
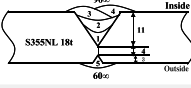
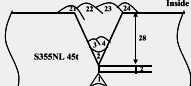
Wire	Dia. (mm)	Th. (mm)	Groove Design (mm)	Pass	Amp. (A)	Volt. (V)	Speed (cm/min)	Remarks
M-12K (A-2)	4.0	25		1-13	570	30	40	AWS A5.17/ A5.23
M-12K	4.0	18		In 1 2-4 Out 5	550 600 650	28 32 34	40 40 40	Both Side Multi- pass
M-12K	4.0	45		In 1 2-24 Out 25 26-27	600-650 650 650	30-32 30 32	40-45 40 35	Both Side Multi- pass Sealing : SM-70(1.2mm)

# S-800WT X M-12K

Type : Neutral



## Conformances

AWS A5.17/ ASME SFA5.17 F7A8-EM12K  
 EN ISO 14174 S A FB 1 / EN ISO 14171 S2Si  
 TÜV EN ISO 14174 - S A FB 1 / EN ISO 14171-A - S2Si

CE  
 CWB CSA W48 F49A(P)6-EM12K  
 DB DIN EN 760-S A FB1  
 DIN EN ISO 14171-A-S2Si

## Applications

- Windtower
- Power plant

## Features

- Good bead appearance
- Easy to remove slag
- Low consumption of flux
- Density : 1.1g/cm<sup>3</sup>

## Current

AC, DC +

## Basicity Index

2.7

## Packages (Flux)

Tin Can 20kg(44lbs)  
 PE Bag 20kg(44lbs)

## Flux Composition

Consumable	Chemical Composition, wt%			
	SiO <sub>2</sub> + TiO <sub>2</sub>	Al <sub>2</sub> O <sub>3</sub> + MnO	CaO + MgO	CaF <sub>2</sub>
S-800WT	10	30	40	15

## Diameter / Packaging

Diameter mm (in)	Spool	Basket			Coil					Pac				
	20kg (44lbs)	25kg (55lbs)	100kg (220lbs)	25kg (55lbs)	100kg (220lbs)	200kg (440lbs)	250kg (551lbs)	300kg (661lbs)	500kg (1102lbs)	200kg (440lbs)	250kg (551lbs)	300kg (661lbs)	350kg (771lbs)	400kg (881lbs)
1.6 (1/16)	✓			✓									✓	
2.0 (5/64)	✓			✓							✓		✓	✓
2.4 (3/32)		✓	✓	✓	✓									✓
3.2 (1/8)		✓	✓	✓	✓					✓				✓
4.0 (5/32)		✓	✓	✓	✓	✓				✓	✓	✓		✓
4.8 (3/16)				✓	✓			✓	✓	✓				

**Typical Chemical Composition of All-Weld Metal(%)**

Wire	C	Si	Mn	P	S	Ti	B	BM	Th.(mm)
M-12K	0.090	0.20	1.45	0.020	0.010	0.008	0.0020	SM490	25

**Typical Mechanical Properties of All-Weld Metal**

Wire	YS MPa(lbs/in <sup>2</sup> )	TS MPa(lbs/in <sup>2</sup> )	EL (%)	Position of fracture	Temp °C(°F)	CVN-Impact Value J (ft.-lbs)	BM	Th.(mm)
M-12K	520 (75,400)	570 (82,700)	32.0	-	-60 (-76)	130 (95)	SM490	25
	-	550 (79,800)		BM	-60 (-76)	100 (74)	S355NL	25

**Typical Welding Conditions**

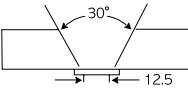
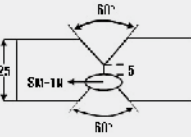
Wire	Dia. (mm)	Th. (mm)	Groove Design (mm)	Pass	Amp. (A)	Volt. (V)	Speed (cm/min)	Remarks
M-12K	4.0	25		1~13	570	30	40	AWS A5.17
M-12K	4.8	25		1	320	28	70	SM-1N
				1st	(L)750 (T)650	28 34	60 60	Both Side Single- pass
				2nd	(L)900 (T)650	32 38	65 65	(tandem)

# Superflux600 X H-14(A-3)

Type : Neutral

## Conformances

AWS A5.17/ ASME SFA5.17 F7A(P)6-EH14  
 JIS Z3183 S502-H  
 AWS A5.23/ ASME SFA5.23 F8A(P)4-EA3-G  
 JIS Z3183 S584-H  
 EN ISO 14174 S A AB 1 / EN ISO 14171 S4[S4Mo]

## Applications

- Structure fabrication (HSB500(SM490) and HSB600(SM570))

## Features

- Good bead appearance
- Easy to remove slag
- Good resistance to pockmarks and pits
- Density : 1.2g/cm<sup>3</sup>

## Current

AC, DC +

## Basicity Index

1.9

## Packages (Flux)

Tin Can 20kg(44lbs)  
 PE Bag 20kg(44lbs)

## Flux Composition

Consumable	Chemical Composition, wt%			
	SiO <sub>2</sub> + TiO <sub>2</sub>	CaO + MgO	Al <sub>2</sub> O <sub>3</sub> + MnO	CaF <sub>2</sub>
Superflux600	15	35	25	20

## Diameter / Packaging

- H-14 : ✓      • A-3 : ○

Diameter	Spool		Basket		Coil					Pac				
	20kg (44lbs)	25kg (55lbs)	100kg (220lbs)	25kg (55lbs)	100kg (220lbs)	200kg (440lbs)	250kg (551lbs)	300kg (661lbs)	500kg (1102lbs)	200kg (440lbs)	250kg (551lbs)	300kg (661lbs)	350kg (771lbs)	400kg (881lbs)
1.6 (1/16)	✓○			✓							✓		○	✓
2.0 (5/64)	✓○			✓○	✓	✓	✓					✓		
2.4 (3/32)	✓	✓		✓○	✓	✓								
3.2 (1/8)		✓		✓○	✓○	✓	✓	✓○			✓○	✓	✓	
4.0 (5/32)		✓		✓○	✓○	✓○		✓○	✓○	✓	✓○	✓	✓	✓
4.8 (3/16)	✓			✓○	✓○			✓○	✓					
6.4 (1/4)				✓	✓									

**Typical Chemical Composition of All-Weld Metal(%)**

Wire	C	Si	Mn	P	S	Mo	BM	Th.(mm)
H-14	0.08	0.20	1.50	0.020	0.006	-	SS400	25
A-3	0.07	0.21	1.45	0.018	0.006	0.45	SM570	25
A-3	0.05	0.28	1.50	0.017	0.003	0.42	HSB600	80

**Typical Mechanical Properties of All-Weld Metal**

Wire	YS MPa(lbs/in <sup>2</sup> )	TS MPa(lbs/in <sup>2</sup> )	EL (%)	Position of fracture	CVN-Impact Value J (ft.-lbs)			BM	Th. (mm)
					-20°C (-4°F)	-40°C (-40°F)	-51°C (-60°F)		
H-14	516 (74,800)	558 (80,900)	31	-	-	-	150 (111)	SS400	25
A-3	621 (90,100)	660 (95,700)	27	-	-	120 (89)	-	SM570	25
A-3	-	632 (91,700)	-	B.M.	100 (74)	-	-	HSB600	45

**Typical Welding Conditions**

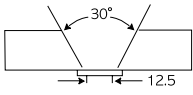
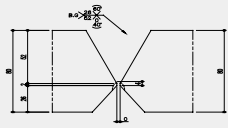
Wire	Dia. (mm)	Th. (mm)	Groove Design (mm)	Pass	Amp. (A)	Volt. (V)	Speed (cm/min)	Remarks
H-14 (A-3)	4.0	25		1-13	570	30	40	AWS A5.17/ A5.23
A-3	4.8	80		1 2-18 19-26	500 550-650 500-650	28 28-32 28-32	40 18-40 20-40	Both Side Multi- pass

SWAW

SAW

GMWAW

GTAW

FCAW

Non-FERROUS

APPENDIX

# S-800MX X A-G(A-3)

Type : Neutral

## Conformances

AWS A5.23/ ASME SFA5.23 F8A0-EG-G  
 JIS Z3183 S502-H  
 AWS A5.23/ ASME SFA5.23 F8AZ-EA3-G  
 JIS Z3183 S582-H  
 EN ISO 14174 S A AR 1 / EN ISO 14171 S4[S4Mo]

## Applications

- Structural fabrication

## Features

- Easy to remove slag
- Tandem welding applicable (H-beam)
- Density : 1.0g/cm<sup>3</sup>

## Current

AC, DC +

## Basicity Index

0.8

## Packages (Flux)

Tin Can 20kg(44lbs)  
 PE Bag 20kg(44lbs)

## Flux Composition

Consumable	Chemical Composition, wt%		
	SiO <sub>2</sub> + TiO <sub>2</sub>	CaO + MgO	Al <sub>2</sub> O <sub>3</sub> + MnO
S-800MX	40	20	35

## Diameter / Packaging

- A-G : ✓      • A-3 : ○

Diameter	Spool		Basket		Coil					Pac				
	20kg (44lbs)	25kg (55lbs)	100kg (220lbs)	25kg (55lbs)	100kg (220lbs)	200kg (440lbs)	250kg (551lbs)	300kg (661lbs)	500kg (1102lbs)	200kg (440lbs)	250kg (551lbs)	300kg (661lbs)	350kg (771lbs)	400kg (881lbs)
1.6 (1/16)	○												○	
2.0 (5/64)	○			○										
2.4 (3/32)				○										
3.2 (1/8)				○	○			○				○		
4.0 (5/32)				√○	○	○		○	○			○		
4.8 (3/16)				√○	√○			√○						



**Typical Chemical Composition of All-Weld Metal(%)**

Wire	C	Si	Mn	P	S	Mo	BM
A-G	0.09	0.40	1.20	0.025	0.010	-	SM520B
A-3	0.08	0.35	1.15	0.020	0.010	0.45	SM570

**Typical Mechanical Properties of All-Weld Metal**

Wire	YS MPa(lbs/in <sup>2</sup> )	TS MPa(lbs/in <sup>2</sup> )	EL (%)	CVN-Impact Value J (ft-lbs)		BM	Th.(mm)
				0°C (32°F)	-18°C (0°F)		
A-G	590 (85,600)	630 (91,400)	27	-	120 (89)	SM520B	25
A-3	650 (94,300)	690 (100,000)	25	80 (59)	-	SM570	25

**Typical Welding Conditions**

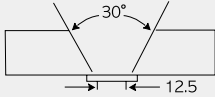
Wire	Dia. (mm)	Th. (mm)	Groove Design (mm)	Pass	Amp. (A)	Volt. (V)	Speed (cm/min)	Remarks
A-G (A-3)	4.0	25		1-13	570	30	40	AWS A5.23

SMW

SAW

GMW

GTAW

FCAW

Non-FERROUS

APPENDIX

# S-800P X M-12K(H-14)

Type : Neutral

## Conformances

AWS A5.17/ ASME SFA 5.17 F7A2-EM12K  
 JIS Z3183 S502-H  
 AWS A5.17/ ASME SFA 5.17 F7A(P)6-EH14  
 JIS Z3183 S502-H  
 EN ISO 14174 S A AB 1 / EN ISO 14171 S2Si[S4]

## Applications

- Structural fabrication
- Pipe line

## Features

- Easy to remove slag
- Tandem welding applicable (H-beam)
- Density : 1.2g/cm<sup>3</sup>

## Current

AC, DC +

## Basicity Index

1.9

## Packages (Flux)

Tin Can 20kg(44lbs)  
 PE Bag 20kg(44lbs)

## Flux Composition

Consumable	Chemical Composition, wt%		
	SiO <sub>2</sub> + TiO <sub>2</sub>	CaO + MgO	Al <sub>2</sub> O <sub>3</sub> + CaF <sub>2</sub>
S-800P	20	40	35

## Diameter / Packaging

- M-12K : √    • H-14 : ○

Diameter	Spool		Basket		Coil					Pac				
	20kg (44lbs)	25kg (55lbs)	100kg (220lbs)	25kg (55lbs)	100kg (220lbs)	200kg (440lbs)	250kg (551lbs)	300kg (661lbs)	500kg (1102lbs)	200kg (440lbs)	250kg (551lbs)	300kg (661lbs)	350kg (771lbs)	400kg (881lbs)
1.6 (1/16)	√○			√○							√○		√	○
2.0 (5/64)	√○			√○	○	○	○					○	√	√
2.4 (3/32)	○	√○	√	√○	√○	○								√
3.2 (1/8)		√○	√	√○	√○	○	○			√	○	○	○	√
4.0 (5/32)		√○	√	√○	√○	√○			○	√○	√○	√○	○	√○
4.8 (3/16)	○			√○	√○			√○	√○	√				
6.4 (1/4)				○	○									

**Typical Chemical Composition of All-Weld Metal(%)**

Wire	C	Si	Mn	P	S
M-12K	0.08	0.47	1.06	0.024	0.012
H-14	0.10	0.29	1.56	0.022	0.011

**Typical Mechanical Properties of All-Weld Metal**

Wire	YS MPa(lbs/in <sup>2</sup> )	TS MPa(lbs/in <sup>2</sup> )	EL (%)	CVN-Impact Value J (ft-lbs)	
				-30°C (-22°F)	-50°C (-58°F)
M-12K	460 (66,800)	540 (78,400)	32.0	80 (59)	-
H-14	490 (71,100)	570 (82,800)	30.0	120 (88)	80 (59)

**Typical Welding Conditions**

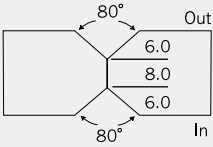
Wire	Dia. (mm)	Th. (mm)	Groove Design (mm)	Pass	Amp. (A)	Volt. (V)	Speed (cm/min)	Remarks
M-12K	4.8	20		1st	800	34	40	Both Side Single-pass
(H-14)				2nd	900	36	35	

# S-800P X A-G(A-3)

Type : Neutral

## Conformances

AWS A5.23/ ASME SFA5.23 F8A4-EG-G  
 JIS Z3183 S582-H  
 AWS A5.23/ ASME SFA5.23 F8A4(P2)-EA3-G  
 JIS Z3183 S584-H  
 EN ISO 14174 S A AB 1 / EN ISO 14171 S4[S4Mo]

## Applications

- Pipe line
- Structural fabrication

## Features

- Easy to remove slag
- Tandem welding applicable (H-beam)
- Density : 1.2g/cm<sup>3</sup>

## Current

AC, DC +

## Basicity Index

1.9

## Packages (Flux)

Tin Can 20kg(44lbs)  
 PE Bag 20kg(44lbs)

## Flux Composition

Consumable	Chemical Composition, wt%		
	SiO <sub>2</sub> + TiO <sub>2</sub>	CaO + MgO	Al <sub>2</sub> O <sub>3</sub> + CaF <sub>2</sub>
S-800P	20	40	35

## Diameter / Packaging

- A-G : ✓      • A-3 : ○

Diameter	Spool		Basket		Coil					Pac				
	20kg (44lbs)	25kg (55lbs)	100kg (220lbs)	25kg (55lbs)	100kg (220lbs)	200kg (440lbs)	250kg (551lbs)	300kg (661lbs)	500kg (1102lbs)	200kg (440lbs)	250kg (551lbs)	300kg (661lbs)	350kg (771lbs)	400kg (881lbs)
1.6 (1/16)	○												○	
2.0 (5/64)	○			○										
2.4 (3/32)				○										
3.2 (1/8)				○	○			○			○			
4.0 (5/32)				√○	○	○		○	○		○			
4.8 (3/16)				√○	√○			√○						

**Typical Chemical Composition of All-Weld Metal(%)**

Wire	C	Si	Mn	P	S	Mo
A-G	0.09	0.30	1.57	0.019	0.008	-
A-3	0.08	0.32	1.54	0.022	0.010	0.40

**Typical Mechanical Properties of All-Weld Metal**

Wire	YS MPa(lbs/in <sup>2</sup> )	TS MPa(lbs/in <sup>2</sup> )	EL (%)	CVN-Impact Value J (ft-lbs)	
				-20°C (-4°F)	-40°C (-40°F)
A-G	520 (75,500)	610 (88,500)	28.0	160 (118)	100 (74)
A-3	630 (91,500)	680 (98,700)	24.0	80 (59)	70 (52)

**Typical Welding Conditions**

Wire	Dia. (mm)	Th. (mm)	Groove Design (mm)	Pass	Amp. (A)	Volt. (V)	Speed (cm/min)	Remarks			
A-G	4.8	20		1st 1	600	30	40	Both Side Multi-pass			
				2-4	600-650	30-32	30-35				
				Back Gouging			5		650	30	40
				2nd 6	650	32	35				
A-3	L(DC+):4.0 T(AC):4.0	17.5		1st	(L)850 (T)650	34 40	120	Both Side Single-pass (tandem)			
				2nd	(L)1000 (T)650	34 40	120				

# S-800CM X B-2

Type : Neutral

## Conformances

AWS A5.23/ ASME SFA5.23 F8P2-EB2-B2  
EN ISO 14174 S A FB 1 / EN ISO 14171 S2CrMo1

## Applications

- Heat resistant steels
- Boiler

## Features

- Good resistance to porosity on rust, scales and primers
- Density : 1.0g/cm<sup>3</sup>

## Current

AC, DC +

## Basicity Index

3.2

## Packages (Flux)

Tin Can 20kg(44lbs)  
PE Bag 20kg(44lbs)

## Flux Composition

Consumable	Chemical Composition, wt%		
	Al <sub>2</sub> O <sub>3</sub> + Fe <sub>2</sub> O <sub>3</sub>	CaF <sub>2</sub> + MgO	SiO <sub>2</sub> + CaO
S-800CM	20	55	25

## Diameter / Packaging

Diameter mm (in)	Spool		Basket		Coil					Pac				
	20kg (44lbs)	25kg (55lbs)	100kg (220lbs)	25kg (55lbs)	100kg (220lbs)	200kg (440lbs)	250kg (551lbs)	300kg (661lbs)	500kg (1102lbs)	200kg (440lbs)	250kg (551lbs)	300kg (661lbs)	350kg (771lbs)	400kg (881lbs)
2.0 (5/64)				✓	✓							✓	✓	
2.4 (3/32)		✓		✓	✓							✓		
3.2 (1/8)				✓								✓		
4.0 (5/32)				✓	✓							✓		

**Typical Chemical Composition of All-Weld Metal(%)**

Wire	C	Si	Mn	P	S	Cr	Mo	BM	Th.(mm)
B-2	0.08	0.25	0.84	0.017	0.004	1.21	0.45	A387 Grade II	25

**Typical Mechanical Properties of All-Weld Metal**

Wire	YS MPa(lbs/in <sup>2</sup> )	TS MPa(lbs/in <sup>2</sup> )	EL (%)	Temp °C(°F)	CVN-Impact Value J (ft-lbs)	BM	Th.(mm)
B-2	610 (88,500)	665 (96,400)	25.6	-29 (-20)	40 (34)	A387 Grade II	25

**Typical Welding Conditions**

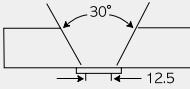
Wire	Dia. (mm)	Th. (mm)	Groove Design (mm)	Pass	Amp. (A)	Volt. (V)	Speed (cm/min)	Remarks
B-2	4.0	25		1-13	570	30	40	AWS A5.23

SMW

SAW

GMW

GTAW

FCAW

Non-FERROUS

APPENDIX

# S-800SP X M-12K(A-2)

Type : Neutral

## Conformances

AWS A5.17/ ASME SFA5.17 F7A4-EM12K  
 JIS Z3183 S502-H  
 AWS A5.23/ ASME SFA5.23 F9TA4G-A2 / F8A2-EA2-G  
 JIS Z3183 S582-H  
 EN ISO 14174 S A AB 1 / EN ISO 14171 S2Si[S2Mo]

## Applications

- Pipe line

## Features

- Good resistance to porosity on rust, scales and primers
- High speed welding (Spiral pipes)
- Density : 1.2g/cm<sup>3</sup>

## Current

AC, DC +

## Basicity Index

1.2

## Packages (Flux)

Tin Can 20kg(44lbs)  
 PE Bag 20kg(44lbs)

## Flux Composition

Consumable	Chemical Composition, wt%			
	SiO <sub>2</sub> + TiO <sub>2</sub>	CaO + MgO	Al <sub>2</sub> O <sub>3</sub> + MnO	CaF <sub>2</sub>
S-800SP	20	25	30	20

## Diameter / Packaging

- M-12K : √
- A-2 : ○

Diameter	Spool		Basket		Coil					Pac				
	20kg (44lbs)	25kg (55lbs)	100kg (220lbs)	25kg (55lbs)	100kg (220lbs)	200kg (440lbs)	250kg (551lbs)	300kg (661lbs)	500kg (1102lbs)	200kg (440lbs)	250kg (551lbs)	300kg (661lbs)	350kg (771lbs)	400kg (881lbs)
1.6 (1/16)	√○			√									√	
2.0 (5/64)	√	○		√○							√	○	√	√
2.4 (3/32)		√○	√	√○	√									√
3.2 (1/8)		√○	√	√○	√			○		√				√
4.0 (5/32)		√○	√	√○	√○	√○	○		√○	√	√○	√○	○	√○
4.8 (3/16)				√	√			√	√	√				



Typical Chemical Composition of All-Weld Metal(%)

Wire	C	Si	Mn	P	S	Mo	BM	Th.(mm)
M-12K	0.07	0.35	1.30	0.020	0.006	-	SS400	25
A-2	0.09	0.27	1.20	0.018	0.007	0.39	SM570	25
A-2	0.08	0.23	1.40	0.013	0.004	0.14	API 5L X65	11.1

Typical Mechanical Properties of All-Weld Metal

Wire	YS MPa(lbs/in <sup>2</sup> )	TS MPa(lbs/in <sup>2</sup> )	EL (%)	Position of fracture	CVN-Impact Value J (ft.lbs)			BM	Th. (mm)
					-20°C (-4°F)	-30°C (-22°F)	-40°C (-40°F)		
M-12K	505 (73,200)	587 (85,100)	28	-	-	-	70 (52)	SS400	25
A-2	580 (84,200)	654 (94,900)	26	-	-	80 (59)	-	SM570	25
A-2	-	590 (85,600)	-	BM	80 (59)	70 (52)	-	API 5L X65	11.1

Typical Welding Conditions

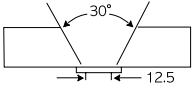
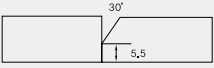
Wire	Dia. (mm)	Th. (mm)	Groove Design (mm)	Pass	Amp. (A)	Volt. (V)	Speed (cm/min)	Remarks
M-12K (A-2)	4.0	25		1~13	570	30	40	AWS A5.17/ A5.23
A-2	L(DC+):4.0 T(AC):4.0	11.1		In side 1st	(L)1050 (T)620	34 40	200	Both Side Single- pass (tandem)
				Out side 2nd	(L)1000 (T)660	34 40		

# S-900SP X M-12K(A-2)

Type : Neutral

## Conformances

AWS A5.17/ ASME SFA5.17 F7A4(P2)-EM12K  
 JIS Z3183 S502-H  
 AWS A5.23/ ASME SFA5.23 F9A2-EA2-G  
 JIS Z3183 S582-H  
 EN ISO 14174 S A CS 1 / EN ISO 14171 S2Si[S2Mo]

NAKS (S-900SPxA-2)

## Applications

- Pipe line

## Features

- Good resistance to porosity on rust, scales and primers
- High speed welding (Longitudinal pipes)
- Density : 1.2g/cm<sup>3</sup>

## Current

AC, DC +

## Basicity Index

1.5

## Packages (Flux)

Tin Can 20kg(44lbs)  
 PE Bag 20kg(44lbs)

## Flux Composition

Consumable	Chemical Composition, wt%			
	SiO <sub>2</sub> + TiO <sub>2</sub>	CaO + MgO	Al <sub>2</sub> O <sub>3</sub> + MnO	CaF <sub>2</sub>
S-900SP	15	50	25	10

## Diameter / Packaging

- M-12K : √
- A-2 : ○

Diameter	Spool		Basket		Coil					Pac				
	20kg (44lbs)	25kg (55lbs)	100kg (220lbs)	25kg (55lbs)	100kg (220lbs)	200kg (440lbs)	250kg (551lbs)	300kg (661lbs)	500kg (1102lbs)	200kg (440lbs)	250kg (551lbs)	300kg (661lbs)	350kg (771lbs)	400kg (881lbs)
1.6 (1/16)	√○			√									√	
2.0 (5/64)	√	○		√○							√	○	√	√
2.4 (3/32)		√○	√	√○	√									√
3.2 (1/8)		√○	√	√○	√			○		√				√
4.0 (5/32)		√○	√	√○	√○	√○	○		√○	√	√○	√○	○	√○
4.8 (3/16)				√	√			√	√	√				

**Typical Chemical Composition of All-Weld Metal(%)**

Wire	C	Si	Mn	P	S	Mo	BM	Th.(mm)
M-12K	0.09	0.35	1.55	0.024	0.004	-	SS400	25
A-2	0.11	0.26	1.51	0.019	0.006	0.39	SM570	25
A-2	0.08	0.23	1.54	0.013	0.004	0.15	API 5L X70	15.9

**Typical Mechanical Properties of All-Weld Metal**

Wire	YS MPa(lbs/in <sup>2</sup> )	TS MPa(lbs/in <sup>2</sup> )	EL (%)	Position of fracture	CVN-Impact Value J (ft.lbs)			BM	Th. (mm)
					-20°C (-4°F)	-30°C (-22°F)	-40°C (-40°F)		
M-12K	525 (76,100)	575 (83,400)	28	-	-	-	70 (52)	SS400	25
A-2	650 (94,300)	710 (103,000)	24	-	-	60 (44)	-	SM570	25
A-2	-	620 (89,900)	-	BM	60 (44)	-	-	API 5L X70	15.9

**Typical Welding Conditions**

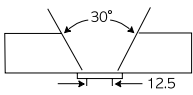
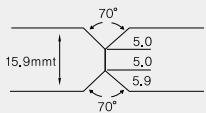
Wire	Dia. (mm)	Th. (mm)	Groove Design (mm)	Pass	Amp. (A)	Volt. (V)	Speed (cm/min)	Remarks
M-12K (A-2)	4.0	25		1~13	570	30	40	AWS A5.17/A5.23
A-2	L(DC+):4.0 T(AC):4.0	15.9		In side 1st Out side 2nd	(L)980 (T)800 (L)1000 (T)780	34 38 39 40	100 110	Both Side Single-pass (tandem)

# S-460Y X H-14

Type : Neutral

## Conformances

AWS A5.23/ ASME SFA5.23 F8A8-EH14-G

JIS Z3183 S584-H

EN ISO 14174 S A FB 1 / EN ISO 14171 S4

KR 5Y46MH5

ABS 5YQ460M H5

LR 5Y46 H5

BV A5Y46M HHH

DNV VY46M(H5)

GL 6Y46MH5

NK KAW5Y46MH5,  
KAW63Y47MH5  
(-20°C ≥53J)

## Applications

- Shipbuilding
- High strength steels (EH47)

## Features

- Good impact value at low temperature and high tensile strength
- Single and multi electrode welding applicable
- Density : 1.2g/cm<sup>3</sup>

## Current

AC, DC +

## Basicity Index

2.5

## Packages (Flux)

Tin Can 20kg(44lbs)

PE Bag 20kg(44lbs)

## Flux Composition

Consumable	Chemical Composition, wt%			
	SiO <sub>2</sub> + TiO <sub>2</sub>	CaO + MgO	Al <sub>2</sub> O <sub>3</sub> + MnO	CaF <sub>2</sub>
S-460Y	20	40	20	15

## Diameter / Packaging

Diameter mm (in)	Spool			Basket						Coil				Pac				
	20kg (44lbs)	25kg (55lbs)	100kg (220lbs)	25kg (55lbs)	100kg (220lbs)	200kg (440lbs)	250kg (551lbs)	300kg (661lbs)	500kg (1102lbs)	200kg (440lbs)	250kg (551lbs)	300kg (661lbs)	350kg (771lbs)	400kg (881lbs)				
1.6 (1/16)	✓			✓							✓			✓				
2.0 (5/64)	✓			✓	✓	✓	✓					✓						
2.4 (3/32)	✓	✓		✓	✓	✓												
3.2 (1/8)		✓		✓	✓	✓	✓	✓			✓	✓	✓					
4.0 (5/32)		✓		✓	✓	✓		✓	✓	✓	✓	✓	✓	✓				
4.8 (3/16)	✓			✓	✓			✓	✓									
6.4 (1/4)				✓	✓													

**Typical Chemical Composition of All-Weld Metal(%)**

Wire	C	Si	Mn	P	S	BM
H-14	0.10	0.28	1.50	0.020	0.005	SM570

**Typical Mechanical Properties of All-Weld Metal**

Wire	YS MPa(lbs/in <sup>2</sup> )	TS MPa(lbs/in <sup>2</sup> )	EL (%)	Temp °C(°F)	CVN-Impact Value J (ft-lbs)	BM	Th.(mm)
H-14	610 (88,500)	640 (92,800)	27.0	-60 (-76)	100 (74)	SM570	25

**Typical Welding Conditions**

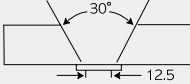
Wire	Dia. (mm)	Th. (mm)	Groove Design (mm)	Pass	Amp. (A)	Volt. (V)	Speed (cm/min)	Remarks
H-14	4.0	25		1-13	570	30	40	AWS A5.23

SMW

SAW

GMAW

GTAW

FCAW

Non-FERROUS

APPENDIX

# S-100 X F-3(M-4)

Type : Neutral

## Conformances

AWS A5.23/ ASME SFA5.23 F9A(P)8-EF3-F3  
AWS A5.23/ ASME SFA5.23 F11A(P)8-EG-M4  
EN ISO 14174 S A FB 1 / EN ISO 14171 S3Ni1Mo

## Applications

- Shipbuilding
- Offshore structure

## Features

- Good impact value at low temperature and high tensile strength
- Density : 1.1g/cm<sup>3</sup>

## Current

AC, DC +

## Basicity Index

3.0

## Packages (Flux)

Tin Can 20kg(44lbs)

PE Bag 20kg(44lbs)

## Flux Composition

Consumable	Chemical Composition, wt%			
	Al <sub>2</sub> O <sub>3</sub> + MnO	CaF <sub>2</sub>	CaO + MgO	SiO <sub>2</sub> + TiO <sub>2</sub>
S-100	20	25	40	15

**Typical Chemical Composition of All-Weld Metal(%)**

Wire	C	Si	Mn	P	S	Cr	Ni	Mo	BM	Th.(mm)
F-3	0.09	0.27	1.71	0.014	0.004	0.05	0.98	0.44	A516 Gr.70	25
M-4	0.08	0.28	1.55	0.015	0.008	0.48	2.26	0.47	A516 Gr.70	25

**Typical Mechanical Properties of All-Weld Metal**

Wire	YS MPa(lbs/in <sup>2</sup> )	TS MPa(lbs/in <sup>2</sup> )	EL (%)	PWHT condition	Temp °C(°F)	CVN-Impact Value J (ft.-lbs)	BM	Th.(mm)
F-3	660 (95,700)	709 (102,800)	25	As welded	-62 (-80)	46 (34)	A516 Gr.70	25
	641 (93,000)	698 (101,200)	28	620°C×1hr	-62 (-80)	38 (28)	A516 Gr.70	25
M-4	771 (111,800)	803 (116,500)	24	As welded	-62 (-80)	83 (61)	A516 Gr.70	25
	706 (102,400)	796 (115,400)	25	620°C×1hr	-62 (-80)	41 (30)	A516 Gr.70	25

**Typical Welding Conditions**

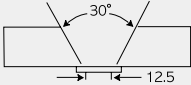
Wire	Dia. (mm)	Th. (mm)	Groove Design (mm)	Pass	Amp. (A)	Volt. (V)	Speed (cm/min)	Remarks
F-3 (M-4)	4.0	25		1~13	570	30	40	AWS A5.23

# S-705EF X H-14

## Conformances

EN ISO 14174 S A CG-I 1 / EN ISO 14171 S4  
 KR 2SMR, 2YSMR  
 2SR, 2YSR (Max. thick. 25mm)  
 ABS 2, 2Y  
 LR 2A, 2YA

BV A2M, A2YM  
 DNV I1YM (t≤22mm)  
 GL 2YM  
 NK KAW2, KAW52-SMP  
 KAW52SP

## Applications

- Shipbuilding (one-side welding)

## Features

- High deposition rate with high input use
- Suitable for one side welding of TMCP steel
- Density : 1.3g/cm<sup>3</sup>

## Current

AC, DC +

## Basicity Index

4.5

## Packages (Flux)

Tin Can 20kg(44lbs)  
 PE Bag 20kg(44lbs)

## Flux Composition

Consumable	Chemical Composition, wt%				
	SiO <sub>2</sub> + TiO <sub>2</sub>	Al <sub>2</sub> O <sub>3</sub> + MnO	MgO + CaO	CaF <sub>2</sub>	FeO
S-705EF	15	10	35	10	30

## Diameter / Packaging

Diameter mm (in)	Spool		Basket		Coil					Pac				
	20kg (44lbs)	25kg (55lbs)	100kg (220lbs)	25kg (55lbs)	100kg (220lbs)	200kg (440lbs)	250kg (551lbs)	300kg (661lbs)	500kg (1102lbs)	200kg (440lbs)	250kg (551lbs)	300kg (661lbs)	350kg (771lbs)	400kg (881lbs)
1.6 (1/16)	✓			✓							✓			✓
2.0 (5/64)	✓			✓	✓	✓	✓					✓		
2.4 (3/32)	✓	✓		✓	✓	✓								
3.2 (1/8)		✓		✓	✓	✓	✓	✓			✓	✓	✓	
4.0 (5/32)		✓		✓	✓	✓		✓	✓	✓	✓	✓	✓	✓
4.8 (3/16)	✓			✓	✓			✓	✓					
6.4 (1/4)				✓	✓									



**Typical Chemical Composition of All-Weld Metal(%)**

Wire	C	Si	Mn	P	S	Mo	BM	Th.(mm)
H-14	0.10	0.20	1.23	0.017	0.011	0.80	AH36	15
	0.10	0.21	1.29	0.014	0.010	0.90	AH36	20

**Typical Mechanical Properties of All-Weld Metal**

Wire	YS MPa(lbs/in <sup>2</sup> )	TS MPa(lbs/in <sup>2</sup> )	EL (%)	Temp °C(°F)	CVN-Impact Value J (ft.lbs)	BM	Th.(mm)
H-14	430 (62,400)	560 (81,300)	23	0 (32)	60 (44)	AH36	15
	400 (58,000)	550 (79,800)	23	0 (32)	60 (44)	AH36	20

**Typical Welding Conditions**

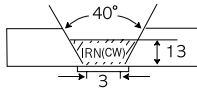
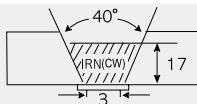
Wire	Dia. (mm)	Th. (mm)	Groove Design (mm)	Pass	Amp. (A)	Volt. (V)	Speed (cm/min)	Remarks
H-14	4.8	15		1	900	35	22	
H-14	4.8	20		1	1000	36	20	

SAW

SAW

GMW

GTAW

FCAW

Non-FERROUS

APPENDIX

# S-705HF X H-14

## Conformances

EN	ISO 14174 S A CG-I 1 / EN ISO 14171 S4
KR	3Y-SMR (Max. thick. 25mm) 3Y-SR
ABS	3Y
LR	3YA
BV	A3YM

DNV	IIIYM (t≤25mm)
GL	3YM, 3Y
NK	KAW53-SMP (Max. thick. 25mm) KAW53SP (Max. thick. 25mm)

## Applications

- Shipbuilding (one-side welding)

## Features

- High deposition rate with high input use
- Suitable for one side welding of TMCP steel
- Density : 1.3g/cm<sup>3</sup>

## Current

AC, DC +

## Basicity Index

4.2

## Packages (Flux)

Tin Can 20kg(44lbs)  
PE Bag 20kg(44lbs)

## Flux Composition

Consumable	Chemical Composition, wt%				
	SiO <sub>2</sub> + TiO <sub>2</sub>	Al <sub>2</sub> O <sub>3</sub> + MnO	MgO + CaO	CaF <sub>2</sub>	FeO
S-705HF	15	8	37	10	30

## Diameter / Packaging

Diameter mm (in)	Spool		Basket		Coil					Pac				
	20kg (44lbs)	25kg (55lbs)	100kg (220lbs)	25kg (55lbs)	100kg (220lbs)	200kg (440lbs)	250kg (551lbs)	300kg (661lbs)	500kg (1102lbs)	200kg (440lbs)	250kg (551lbs)	300kg (661lbs)	350kg (771lbs)	400kg (881lbs)
1.6 (1/16)	✓			✓							✓			✓
2.0 (5/64)	✓			✓	✓	✓	✓					✓		
2.4 (3/32)	✓	✓		✓	✓	✓								
3.2 (1/8)		✓		✓	✓	✓	✓	✓			✓	✓	✓	
4.0 (5/32)		✓		✓	✓	✓		✓	✓	✓	✓	✓	✓	✓
4.8 (3/16)	✓			✓	✓			✓	✓					
6.4 (1/4)				✓	✓									

**Typical Chemical Composition of All-Weld Metal(%)**

Wire	C	Si	Mn	P	S	Mo	Ti	B	BM	Th.(mm)
H-14	0.103	0.26	1.44	0.014	0.006	0.021	0.028	0.0045	EH36	25

**Typical Mechanical Properties of All-Weld Metal**

Wire	YS MPa(lbs/in <sup>2</sup> )	TS MPa(lbs/in <sup>2</sup> )	EL (%)	Temp °C(°F)	CVN-Impact Value J (ft-lbs)	BM	Th.(mm)
H-14	509 (73,800)	618 (89,600)	22.6	-20 (-4)	80 (59)	EH36	25

**Typical Welding Conditions**

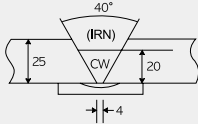
Wire	Dia. (mm)	Th. (mm)	Groove Design (mm)	Pass	Amp. (A)	Volt. (V)	Speed (cm/min)	Remarks
H-14	4.8	25		1	1000	36	16	

# S-400HF X SC-414S, SC-423S, SC-420S, SC-420SG

Type : Neutral

## Conformances

EN ISO 14174 S A AB 3

## Applications

- Cladding flux for hardfacing products

## Features

- Smooth and uniform bead appearance
- Good recovery of alloying element of the hardfacing wire
- Density : 1.1g/cm<sup>3</sup>

## Current

AC, DC +

## Basicity Index

## Packages (Flux)

Tin Can 20kg(44lbs)

PE Bag 20kg(44lbs)

## Flux Composition

Consumable	Chemical Composition, wt%			
	SiO <sub>2</sub> + TiO <sub>2</sub>	Al <sub>2</sub> O <sub>3</sub> + MnO	CaO + MgO	CaF <sub>2</sub>
S-400HF	15	25	35	20

## Typical Chemical Composition of All-Weld Metal(%)

Wire	C	Si	Mn	Cr	Ni	Mo	Nb	W	V
SC-414S	0.10	0.5	1.4	14.9	2.7	1.0	0.20	-	0.4
SC-423S	0.04	0.4	1.3	17.5	3.0	1.2	0.20	-	0.4
SC-420S	0.33	0.8	1.8	12.6	0.5	1.9	0.18	1.4	0.4
SC-420SG	0.29	0.7	1.5	13.9	0.2	-	0.17	-	-

## Hardness of All-Weld Metal

Wire	Dia.(mm)	Hardness (HRc)
SC-414S	2.4/3.2	43-47
SC-423S	3.2	-
SC-420S	3.2	52-56
SC-420SG	3.2	52-56

# Superflux300S X YS-308(L)

Type : Neutral

## Conformances

JIS Z3324 FSS-B1/YS308(L)

EN ISO 14174 S A AB 2

## Applications

- 18%Cr-8%Ni stainless steel

## Features

- Good resistance to crack and corrosion
- Easy to remove slag
- Good bead appearance
- Density : 1.2g/cm<sup>3</sup>

## Current

AC, DC +

## Basicity Index

2.0

## Packages (Flux)

Tin Can 20kg(44lbs)

PE Bag 20kg(44lbs)

## Flux Composition

Consumable	Chemical Composition, wt%			
	SiO <sub>2</sub> + TiO <sub>2</sub>	Al <sub>2</sub> O <sub>3</sub> + MnO	MgO + CaO	CaF <sub>2</sub>
300S	30	20	40	10

SMW

SAW

GMW

GTAW

FCAW

Non-FERROUS

APPENDIX

**Typical Chemical Composition of All-Weld Metal(%)**

Wire	C	Si	Mn	Cr	Ni
YS-308	0.05	0.92	1.30	20.3	9.7
YS-308L	0.03	0.90	1.30	20.3	9.8

**Typical Mechanical Properties of All-Weld Metal**

Wire	TS MPa(lbs/in <sup>2</sup> )	EL (%)	Temp °C(°F)	CVN-Impact Value J (ft-lbs)
YS-308	610 (88,500)	40	-20 (-4)	70 (52)
YS-308L	600 (87,000)	42	-196 (-321)	40 (30)

**Typical Welding Conditions**

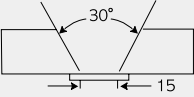
Wire	Dia. (mm)	Th. (mm)	Groove Design (mm)	Pass	Amp. (A)	Volt. (V)	Speed (cm/min)	Remarks
YS-308 YS-308L	4.0	20		1~10	550	32 30	50	JIS Z3324

# Superflux300S X YS-309(L)

Type : Neutral

## Conformances

JIS Z3324 FSS-B1/YS309(L)

EN ISO 14174 S A AB 2

## Applications

- 22%Cr-12%Ni stainless steel

## Features

- Good resistance to crack and corrosion
- Easy to remove slag
- Good bead appearance
- Density : 1.2g/cm<sup>3</sup>

## Current

AC, DC +

## Basicity Index

2.0

## Packages (Flux)

Tin Can 20kg(44lbs)

PE Bag 20kg(44lbs)

## Flux Composition

Consumable	Chemical Composition, wt%			
	SiO <sub>2</sub> + TiO <sub>2</sub>	Al <sub>2</sub> O <sub>3</sub> + MnO	MgO + CaO	CaF <sub>2</sub>
300S	30	20	40	10

SMW

SAW

GMW

GTAW

FCAW

Non-FERROUS

APPENDIX

**Typical Chemical Composition of All-Weld Metal(%)**

Wire	C	Si	Mn	Cr	Ni
YS-309	0.05	0.91	1.40	22.6	12.5
YS-309L	0.03	0.93	1.40	22.5	12.8

**Typical Mechanical Properties of All-Weld Metal**

Wire	TS MPa(lbs/in <sup>2</sup> )	EL (%)	Temp °C(°F)	CVN-Impact Value J (ft.-lbs)
YS-309	580 (84,200)	36	-20 (-4) -196 (-321)	70 (52) 40 (30)
YS-309L	570 (82,700)	38	-196 (-321)	40 (30)

**Typical Welding Conditions**

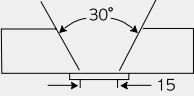
Wire	Dia. (mm)	Th. (mm)	Groove Design (mm)	Pass	Amp. (A)	Volt. (V)	Speed (cm/min)	Remarks
YS-309 YS-309L	4.0	20		1~10	550	32 30	50	JIS Z3324



# Superflux300S X YS-316(L)

Type : Neutral

## Conformances

JIS Z3324 FSS-B1/YS316(L)

EN ISO 14174 S A AB 2

ABS AWS A5.9 ER316L(Wire)  
(-60°C ≥ 34 J)

BV UP (KV -60°C ≥ 27 J)  
(YS-316L)

## Applications

- 18%Cr-12%Ni-2%Mo stainless steel

## Features

- Good resistance to crack and corrosion
- Easy to remove slag
- Good bead appearance
- Density : 1.2g/cm<sup>3</sup>

## Current

AC, DC +

## Basicity Index

2.0

## Packages (Flux)

Tin Can 20kg(44lbs)

PE Bag 20kg(44lbs)

## Flux Composition

Consumable	Chemical Composition, wt%			
	SiO <sub>2</sub> + TiO <sub>2</sub>	Al <sub>2</sub> O <sub>3</sub> + MnO	MgO + CaO	CaF <sub>2</sub>
300S	30	20	40	10

SMW

SAW

GMW

GTAW

FCW

Non-FERROUS

APPENDIX

**Typical Chemical Composition of All-Weld Metal(%)**

Wire	C	Si	Mn	Cr	Ni	Mo
YS-316	0.05	0.90	1.40	19.3	12.2	2.1
YS-316L	0.03	0.90	1.40	19.2	12.1	2.1

**Typical Mechanical Properties of All-Weld Metal**

Wire	TS MPa(lbs/in <sup>2</sup> )	EL (%)	Temp °C(°F)	CVN-Impact Value J (ft-lbs)
YS-316	580 (84,200)	40	-20 (-4) -196 (-321)	80 (59) 40 (30)
YS-316L	550 (79,800)	38	-196 (-321)	40 (30)

**Typical Welding Conditions**

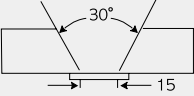
Wire	Dia. (mm)	Th. (mm)	Groove Design (mm)	Pass	Amp. (A)	Volt. (V)	Speed (cm/min)	Remarks
YS-316 YS-316L	4.0	20		1~10	550	32 30	50	JIS Z3324

# Superflux209 X YS-2209

## Conformances

EN ISO 14174 S A AF 2  
 DNV Duplex Stainless Steel

## Applications

- Offshore
- Petrochemical
- Chemical industry

## Features

- Approximate 50:50 microstructure of austenite with a ferrite matrix
- Density : 1.0g/cm<sup>3</sup>

## Current

AC, DC +

## Basicity Index

1.8

## Packages (Flux)

Tin Can 20kg(44lbs)  
 PE Bag 20kg(44lbs)

## Flux Composition

Consumable	Chemical Composition, wt%		
	SiO <sub>2</sub> + TiO <sub>2</sub>	Al <sub>2</sub> O <sub>3</sub>	CaF <sub>2</sub>
Superflux209	10	40	50

## Typical Chemical Composition of All-Weld Metal(%)

C	Si	Mn	P	S	Cr	Ni	Mo	Cu	N
0.02	0.49	1.28	0.017	0.003	22.8	8.15	2.99	0.20	0.20

## Typical Mechanical Properties of All-Weld Metal

TS MPa(lbs/in <sup>2</sup> )	EL (%)	Temp °C(°F)	CVN-Impact Value J (ft-lbs)
805 (116,800)	28	-46 (-50)	70 (52)

SMW

SAW

GMW

GTAW

FCW

Non-FERROUS

APPENDIX

# S-300EM X Flux for ESW

## Conformances

EN ISO 14174 SA AF2

## Applications

- Heat exchanger, pressure vessels

## Features

- Good resistance to crack and corrosion
- Easy to remove slag
- Good bead appearance
- Density : 1.2g/cm<sup>3</sup>

## Current

DC +

## Basicity Index

## Packages (Flux)

Tin Can 20kg(44lbs)

## Flux Composition

Consumable	Chemical Composition, wt%		
	SiO <sub>2</sub> + TiO <sub>2</sub>	Al <sub>2</sub> O <sub>3</sub> + MnO	CaF <sub>2</sub>
S-300EM	5	30	60

## Typical Chemical Composition of Strip Band(%)

Wire	C	Mn	Si	S	P	Cr	Ni	Mo	Nb	N
YSB-308L	0.01	1.7	0.3	0.001	0.015	20.3	10.4			0.044
YSB-309L	0.01	1.6	0.4	0.002	0.01	24.2	13.4	0.1		0.054
YSB-347	0.02	1.1	0.4	0.001	0.018	19.7	10.5	0.1	0.5	0.043
YSB-316L	0.01	1.8	0.4	0.001	0.016	18.1	12.6	2.9		0.047
YSB-309LMo	0.01	2	0.3	0.001	0.018	20.3	13.8	2.7		0.081
YSB-309LNb	0.02	2	0.3	0.011	0.018	21.2	12.0	0.1	0.6	0.049

## Typical Chemical Composition of All-Weld Metal(%)

Wire	C	Mn	Si	Cr	Ni	Mo	Nb	N	F.N
YSB-308L	0.02	1.45	0.55	19.3	10.9			0.054	8
YSB-309L	0.03	1.45	0.7	19.5	11			0.045	6
YSB-347	0.03	0.95	0.9	19.5	10.5			0.038	6
YSB-316L	0.03	1.5	0.63	18.5	12.5	2.5		0.045	7
YSB-309LMo	0.03	1.52	0.49	18.2	13.1	2.36	0.04	0.061	5
YSB-309LNb	0.03	1.36	0.37	18.9	10.4	0.05	0.48	0.024	5

# GMAW

## Solid Wire & Stainless Mig Wire



# SM-70

Mild Steel & 490 MPa high tensile steels



## Conformances

AWS A5.18 / ASME SFA5.18 ER70S-6  
 JIS Z3312 YGW12  
 EN ISO 14341-A G 42 2 C 3Si1 / 14341-A G 42 4 M 3Si1  
 KR 3SG, 3YSG(C)  
 ABS 3SA, 3YSA  
 LR 3YS, 3YM H15  
 TÜV EN ISO 14341-A - G42 2 C1 3Si1 / G42 4 M21 3Si1  
 DB DIN EN ISO 14341-A-G 42 2 C1 3Si1  
 DIN EN ISO 14341-A-G 42 4 M21 3Si1

BV SA3, SA3YM  
 DNV IIIYMS  
 GL 3YS  
 NK KSW53G(C)  
 CWB CSA W48 B-G 49A 3 C G6  
 NAKS  
 RS 3YSM  
 CE

## Applications

- General fabrication
- Steel Industry
- Automotive

## Features

- All position welding by short-circuiting type transfer
- Stable arc and low spatter
- Good bead appearance

## Welding Position



1G 2F 3G 4G  
 (PA) (PB) (PF-PG) (PE)

## Current

DC +

## Shielding Gas

100% CO<sub>2</sub>  
 Ar + 20~25% CO<sub>2</sub>

## Diameter / Packaging

Diameter	Spool			Pac		
	5kg (11lbs)	15kg (33lbs)	20kg (44lbs)	250kg (551lbs)	300kg (661lbs)	350kg (771lbs)
0.8 (0.033)	✓	✓	✓	✓	✓	✓
0.9 (0.035)	✓	✓	✓	✓	✓	✓
1.0 (0.040)	✓	✓	✓	✓	✓	✓
1.2 (0.045)	✓	✓	✓	✓	✓	✓
1.4 (0.052)	✓	✓	✓	✓	✓	✓
1.6 (1/16)	✓	✓	✓	✓	✓	✓

### Typical Chemical Composition of the Wire(%)

C	Si	Mn	P	S
0.07	0.83	1.48	0.011	0.015

### Typical Mechanical Properties of All-Weld Metal

	YS MPa(lbs/in <sup>2</sup> )	TS MPa(lbs/in <sup>2</sup> )	EL (%)	Temp °C(°F)	CVN-Impact Value J (ft.-lbs)
As welded with 100% CO <sub>2</sub>	460 (67,000)	555 (80,000)	29.3	-29 (-20)	85 (63)
As welded with 80% Ar + CO <sub>2</sub>	495 (72,000)	585 (85,000)	27.5	-29 (-20)	113 (83)
As welded with 90% Ar + CO <sub>2</sub>	495 (72,000)	590 (85,600)	26.4	-29 (-20)	101 (74)

### Typical Operating Procedures

Diameter, Polarity Shielding Gas	CTWD mm(in)	Wire Feed Speed m/min (in/min)	Voltage (volts)	Approx. Current (amps)	Melt-Off Rate kg/hr (lb/hr)
<b>1.2mm (0.045in), DC +</b>					
100% CO <sub>2</sub> Gas	20 (3/4)	5.8 (230)	18.5	150	2.9 (6.4)
		9.0 (350)	25	200	4.5 (9.9)
		14.5 (570)	31	280	7.3 (16.1)
Mixed Gas (Ar + CO <sub>2</sub> )	20 (3/4)	3.7 (145)	17.5	150	1.9 (4.2)
		6.2 (244)	24	200	3.1 (6.8)
		11.2 (440)	30	280	5.6 (12.3)
<b>1.4mm (0.052in), DC +</b>					
100% CO <sub>2</sub> Gas	20 (3/4)	8.8 (346)	29	250	6.1 (13.4)
		12.0 (472)	34	300	8.3 (18.3)
		14.6 (575)	36	340	10.1 (22.2)
Mixed Gas (Ar + CO <sub>2</sub> )	20 (3/4)	6.6 (260)	28	250	4.6 (10.1)
		8.7 (343)	32	300	6.0 (13.2)
		9.5 (374)	35	340	6.6 (14.5)
<b>1.6mm (1/16in), DC +</b>					
100% CO <sub>2</sub> Gas	20 (3/4)	8.6 (339)	34	320	7.8 (17.2)
		9.4 (370)	37	340	8.5 (18.7)
		11.7 (460)	43	390	10.6 (23.3)
Mixed Gas (Ar + CO <sub>2</sub> )	20 (3/4)	6.2 (244)	30	320	5.6 (12.3)
		6.6 (260)	34	340	6.0 (13.2)
		8.2 (322)	38	390	7.4 (16.3)

# SM-70EN

Mild Steel & 490 MPa high tensile steels



## Conformances

AWS A5.18/ ASME SFA5.18 ER70S-6  
 JIS Z3312 YGW12  
 EN ISO 14341-A G 42 2 C 4Si1  
 EN ISO 14341-A G 46 4 M 4Si1  
 TÜV EN ISO 14341-A - G42 2 C1 4Si1 / G46 4 M21 4Si1  
 DB DIN EN ISO 14341-A-G 42 2 C1 4Si1  
 DIN EN ISO 14341-A-G 46 4 M21 4Si1

CE  
 DNV IIIY40MS  
 GL 3Y40S

## Applications

- Structural fabrication
- Automotive
- Machinery
- Steel Industry

## Features

- All position welding by short-circuiting type transfer
- Mixed gas
- Good bead appearance and low spatter

## Welding Position

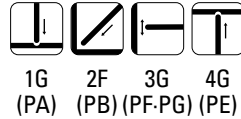

## Current

DC +

## Shielding Gas

Ar + 20~25% CO<sub>2</sub>

## Diameter / Packaging

Diameter mm (in)	Spool			Pac		
	5kg (11lbs)	15kg (33lbs)	20kg (44lbs)	250kg (551lbs)	300kg (661lbs)	350kg (771lbs)
0.8 (0.033)	✓	✓	✓	✓	✓	✓
0.9 (0.035)	✓	✓	✓	✓	✓	✓
1.0 (0.040)	✓	✓	✓	✓	✓	✓
1.2 (0.045)	✓	✓	✓	✓	✓	✓
1.4 (0.052)	✓	✓	✓	✓	✓	✓
1.6 (1/16)	✓	✓	✓	✓	✓	✓



**Typical Chemical Composition of the Wire(%)**

C	Si	Mn	P	S
0.08	0.95	1.7	0.012	0.015

**Typical Mechanical Properties of All-Weld Metal**

	YS MPa(lbs/in <sup>2</sup> )	TS MPa(lbs/in <sup>2</sup> )	EL (%)	Temp °C(°F)	CVN-Impact Value J (ft-lbs)
As welded with 80% Ar + CO <sub>2</sub>	477 (69,000)	540 (86,000)	28.5	-29 (-20)	101 (75)
As welded with 90% Ar + CO <sub>2</sub>	492 (71,300)	585 (85,000)	27.9	-29 (-20)	100 (74)

**Typical Operating Procedures**

Diameter, Polarity Shielding Gas	CTWD mm(in)	Wire Feed Speed m/min (in/min)	Voltage (volts)	Approx. Current (amps)	Melt-Off Rate kg/hr (lb/hr)
<b>1.2mm (0.045in), DC +</b>					
Mixed Gas (Ar + CO <sub>2</sub> )	20 (3/4)	3.7 (145)	17.5	150	1.9 (4.2)
		6.2 (244)	24	200	3.1 (6.8)
		11.2 (440)	30	280	5.6 (12.3)
<b>1.4mm (0.052in), DC +</b>					
Mixed Gas (Ar + CO <sub>2</sub> )	20 (3/4)	6.6 (260)	28	250	4.6 (10.1)
		8.7 (343)	32	300	6.0 (13.2)
		9.5 (374)	35	340	6.6 (14.5)
<b>1.6mm (1/16in), DC +</b>					
Mixed Gas (Ar + CO <sub>2</sub> )	20 (3/4)	6.2 (244)	30	320	5.6 (12.3)
		6.6 (260)	34	340	6.0 (13.2)
		8.2 (322)	38	390	7.4 (16.3)

SMW

SAW

GMW

GTAW

FCAW

Non-FERROUS

APPENDIX

# SM-70G

Mild Steel & 490 MPa high tensile steels

## Conformances

AWS A5.18/ ASME SFA5.18 ER70S-G  
 JIS Z3312 YGW11  
 EN ISO 14341-A G3Si1  
 KR 3SG, 3YSG, 3MG, 3YMG (C1)  
 ABS 3SA, 3YSA  
 LR 3YSH15

BV SA3, 3YM  
 DNV IIIYMS  
 GL 3YS  
 NK KSW53G, KAW53MG(C)  
 KSW3G, KSW53G(M2)  
 KAW3MG, KAW53MG(M2)

## Applications

- Structural fabrication
- Shipbuilding
- Transportation equipment
- Heavy equipment
- Bridge construction

## Features

- Good performance with high current
- High deposition rate
- Deep penetration

## Welding Position



1G 2F 3G 4G  
 (PA) (PB) (PF-PG) (PE)

## Current

DC +

## Shielding Gas

100% CO<sub>2</sub>  
 Ar + 20~25% CO<sub>2</sub>

## Diameter / Packaging

Diameter	Spool			Pac		
	5kg (11lbs)	15kg (33lbs)	20kg (44lbs)	250kg (551lbs)	300kg (661lbs)	350kg (771lbs)
0.8 (0.033)	√	√	√	√	√	√
0.9 (0.035)	√	√	√	√	√	√
1.0 (0.040)	√	√	√	√	√	√
1.2 (0.045)	√	√	√	√	√	√
1.4 (0.052)	√	√	√	√	√	√
1.6 (1/16)	√	√	√	√	√	√

**Typical Chemical Composition of the Wire(%)**

C	Si	Mn	P	S	Ti
0.05	0.82	1.5	0.011	0.010	0.18

**Typical Mechanical Properties of All-Weld Metal**

	YS MPa(lbs/in <sup>2</sup> )	TS MPa(lbs/in <sup>2</sup> )	EL (%)	Temp °C(°F)	CVN-Impact Value J (ft.-lbs)
As welded with 100% CO <sub>2</sub>	518 (75,000)	591 (86,000)	30.4	-29 (-20)	92 (68)
As welded with 80% Ar + CO <sub>2</sub>	534 (77,400)	600 (87,000)	28.6	-29 (-20)	102 (76)
As welded with 90% Ar + CO <sub>2</sub>	554 (80,300)	630 (91,400)	27.4	-29 (-20)	95 (70)

**Typical Operating Procedures**

Diameter, Polarity Shielding Gas	CTWD mm(in)	Wire Feed Speed m/min (in/min)	Voltage (volts)	Approx. Current (amps)	Melt-Off Rate kg/hr (lb/hr)
<b>1.2mm (0.045in), DC +</b>					
100% CO <sub>2</sub> Gas	20 (3/4)	14.5 (570)	31	280	7.3 (16.1)
		17.0 (670)	34	320	8.6 (19.0)
		21.0 (830)	37	350	10.6 (23.3)
Mixed Gas (Ar + CO <sub>2</sub> )	20 (3/4)	11.2 (440)	30	280	5.6 (12.3)
		12.8 (503)	33	320	6.5 (14.3)
		14.0 (551)	36	350	7.1 (15.7)
<b>1.4mm (0.052in), DC +</b>					
100% CO <sub>2</sub> Gas	20 (3/4)	12.0 (472)	34	300	8.3 (18.3)
		14.6 (575)	36	340	10.1 (22.2)
		15.8 (622)	39	360	11.0 (24.2)
Mixed Gas (Ar + CO <sub>2</sub> )	20 (3/4)	8.7 (343)	32	300	6.0 (13.2)
		9.5 (374)	34	340	6.6 (14.5)
		10.0 (394)	35	360	6.9 (15.3)
<b>1.6mm (1/16in), DC +</b>					
100% CO <sub>2</sub> Gas	20 (3/4)	9.4 (370)	37	340	8.5 (18.7)
		11.7 (460)	43	390	10.6 (23.3)
		12.2 (480)	44	400	11.1 (24.4)
Mixed Gas (Ar + CO <sub>2</sub> )	20 (3/4)	6.6 (260)	34	340	6.0 (13.2)
		8.2 (322)	38	390	7.4 (16.3)
		8.6 (339)	38	400	7.8 (17.2)

SMW

SAW

GMAW

GTAW

FCAW

Non-FERROUS

APPENDIX

# SM-70S

Mild Steel & 490 MPa high tensile steels

## Conformances

AWS A5.18/ ASME SFA5.18 ER70S-3

JIS Z3312 YGW16

EN ISO 14341-A G2Si

ABS 3SA, 3YSA

LR 3S, 3YSH15

## Applications

- Automotive
- Galvanized steel
- Machinery

## Features

- All position welding by short-circuiting type transfer
- Mixed gas
- Galvanized steel applicable
- Stable arc and low spatter
- Low slag
- Good bead appearance

## Welding Position



1G 2F 3G 4G  
(PA) (PB) (PF-PG) (PE)

## Current

DC +

## Shielding Gas

Ar + 20~25% CO<sub>2</sub>

## Diameter / Packaging

Diameter	Spool			Pac		
	5kg (11lbs)	15kg (33lbs)	20kg (44lbs)	250kg (551lbs)	300kg (661lbs)	350kg (771lbs)
0.8 (0.033)	✓	✓	✓	✓	✓	✓
0.9 (0.035)	✓	✓	✓	✓	✓	✓
1.0 (0.040)	✓	✓	✓	✓	✓	✓
1.2 (0.045)	✓	✓	✓	✓	✓	✓
1.4 (0.052)	✓	✓	✓	✓	✓	✓
1.6 (1/16)	✓	✓	✓	✓	✓	✓

### Typical Chemical Composition of the Wire(%)

C	Si	Mn	P	S
0.07	0.65	1.14	0.011	0.008

### Typical Mechanical Properties of All-Weld Metal

	YS MPa(lbs/in <sup>2</sup> )	TS MPa(lbs/in <sup>2</sup> )	EL (%)	Temp °C(°F)	CVN-Impact Value J (ft-lbs)
As welded with 80% Ar + CO <sub>2</sub>	455 (66,000)	533 (77,300)	31.2	-20 (-4)	168 (124)
As welded with 90% Ar + CO <sub>2</sub>	467 (67,700)	551 (79,800)	30.6	-20 (-4)	166 (123)

### Typical Operating Procedures

Diameter, Polarity Shielding Gas	CTWD mm(in)	Wire Feed Speed m/min (in/min)	Voltage (volts)	Approx. Current (amps)	Melt-Off Rate kg/hr (lb/hr)
<b>1.2mm (0.045in), DC +</b>					
Mixed Gas (Ar + CO <sub>2</sub> )	20 (3/4)	3.7 (145)	17.5	150	1.9 (4.2)
		6.2 (244)	24	200	3.1 (6.8)
		11.2 (440)	30	280	5.6 (12.3)
<b>1.4mm (0.052in), DC +</b>					
Mixed Gas (Ar + CO <sub>2</sub> )	20 (3/4)	6.6 (260)	28	250	4.6 (10.1)
		8.7 (343)	32	300	6.0 (13.2)
		9.5 (374)	35	340	6.6 (14.5)
<b>1.6mm (1/16in), DC +</b>					
Mixed Gas (Ar + CO <sub>2</sub> )	20 (3/4)	6.2 (244)	30	320	5.6 (12.3)
		6.6 (260)	34	340	6.0 (13.2)
		8.2 (322)	38	390	7.4 (16.3)

SMAW

SAW

GMAW

GTAW

FCAW

Non-FERROUS

APPENDIX

# SM-70GS

Mild Steel & 490 MPa high tensile steels

## Conformances

AWS A5.18/ ASME SFA5.18 ER70S-G

JIS Z3312 YGW15

EN ISO 14341-A G2Si

LR 3YSH15

## Applications

- Shipbuilding
- Structural fabrication
- Transportation equipment
- Heavy equipment

## Features

- Mixed gas
- Good performance high-current
- Good bead appearance
- Low slag

## Welding Position



1G 2F  
(PA) (PB)

## Current

DC +

## Shielding Gas

Ar + 20~25% CO<sub>2</sub>

## Diameter / Packaging

Diameter	Spool			Pac		
	5kg (11lbs)	15kg (33lbs)	20kg (44lbs)	250kg (551lbs)	300kg (661lbs)	350kg (771lbs)
0.8 (0.033)	✓	✓	✓	✓	✓	✓
0.9 (0.035)	✓	✓	✓	✓	✓	✓
1.0 (0.040)	✓	✓	✓	✓	✓	✓
1.2 (0.045)	✓	✓	✓	✓	✓	✓
1.4 (0.052)	✓	✓	✓	✓	✓	✓
1.6 (1/16)	✓	✓	✓	✓	✓	✓

**Typical Chemical Composition of the Wire(%)**

C	Si	Mn	P	S	Ti
0.06	0.62	1.21	0.013	0.007	0.10

**Typical Mechanical Properties of All-Weld Metal**

	YS MPa(lbs/in <sup>2</sup> )	TS MPa(lbs/in <sup>2</sup> )	EL (%)	Temp °C(°F)	CVN-Impact Value J (ft.-lbs)
As welded with 80% Ar + CO <sub>2</sub>	480 (69,600)	550 (79,700)	28.0	-20 (-4)	186 (128)
As welded with 90% Ar + CO <sub>2</sub>	515 (74,600)	556 (80,600)	27.4	-20 (-4)	173 (119)

**Typical Operating Procedures**

Diameter, Polarity Shielding Gas	CTWD mm(in)	Wire Feed Speed m/min (in/min)	Voltage (volts)	Approx. Current (amps)	Melt-Off Rate kg/hr (lb/hr)
<b>1.2mm (0.045in), DC +</b>					
Mixed Gas (Ar + CO <sub>2</sub> )	20 (3/4)	10.1 (397)	28	250	5.1 (11.2)
		11.2 (440)	30	280	5.6 (12.3)
		12.8 (503)	33	320	6.5 (14.3)
<b>1.4mm (0.052in), DC +</b>					
Mixed Gas (Ar + CO <sub>2</sub> )	20 (3/4)	8.7 (343)	32	300	6.0 (13.2)
		9.5 (374)	34	340	6.6 (14.5)
		10.0 (394)	35	360	6.9 (15.3)
<b>1.6mm (1/16in), DC +</b>					
Mixed Gas (Ar + CO <sub>2</sub> )	20 (3/4)	6.6 (260)	34	340	6.0 (13.2)
		8.2 (322)	38	390	7.4 (16.3)
		8.6 (339)	38	400	7.8 (17.2)

SMW

SAW

GMW

GTAW

FCAW

Non-FERROUS

APPENDIX

# SM-1N

High tensile steels

## Conformances

AWS A5.28/ ASME SFA5.28 ER80S-Ni1

ABS AWS A5.28 ER80S-Ni1(-50)

## Applications

- Structural fabrication
- Shipbuilding
- Rail road car
- Heavy equipment

## Features

- Good impact value at low temperature(1% Ni)
- Good performance to mechanical properties

## Welding Position



1G (PA) 2F (PB)

## Current

DC +

## Shielding Gas

Ar + 20~25% CO<sub>2</sub>

## Diameter / Packaging

Diameter mm (in)	Spool			Pac		
	5kg (11lbs)	15kg (33lbs)	20kg (44lbs)	250kg (551lbs)	300kg (661lbs)	350kg (771lbs)
0.8 (0.033)	√	√	√	√	√	√
0.9 (0.035)	√	√	√	√	√	√
1.0 (0.040)	√	√	√	√	√	√
1.2 (0.045)	√	√	√	√	√	√
1.4 (0.052)	√	√	√	√	√	√
1.6 (1/16)	√	√	√	√	√	√



### Typical Chemical Composition of the Wire(%)

C	Si	Mn	P	S	Ni	Cu
0.08	0.62	1.15	0.011	0.01	0.93	0.08

### Typical Mechanical Properties of All-Weld Metal

	YS MPa(lbs/in <sup>2</sup> )	TS MPa(lbs/in <sup>2</sup> )	EL (%)	Temp °C(°F)	CVN-Impact Value J (ft.-lbs)
As welded with 80% Ar + CO <sub>2</sub>	500 (72,500)	585 (84,900)	27.8	-45 -60	115 (85) 62 (45)

### Typical Operating Procedures

Diameter, Polarity Shielding Gas	CTWD mm(in)	Wire Feed Speed m/min (in/min)	Voltage (volts)	Approx. Current (amps)	Melt-Off Rate kg/hr (lb/hr)
<b>1.2mm (0.045in), DC +</b>					
Mixed Gas (Ar + CO <sub>2</sub> )	20 (3/4)	11.2 (440)	30	280	5.6 (12.3)
		12.8 (503)	33	320	6.5 (14.3)
		14.0 (551)	36	350	7.1 (15.7)
<b>1.4mm (0.052in), DC +</b>					
Mixed Gas (Ar + CO <sub>2</sub> )	20 (3/4)	8.7 (343)	32	300	6.0 (13.2)
		9.5 (374)	34	340	6.6 (14.5)
		10.0 (394)	35	360	6.9 (15.3)
<b>1.6mm (1/16in), DC +</b>					
Mixed Gas (Ar + CO <sub>2</sub> )	20 (3/4)	6.6 (260)	34	340	6.0 (13.2)
		8.2 (322)	38	390	7.4 (16.3)
		8.6 (339)	38	400	7.8 (17.2)

# SM-55H

High tensile steels

## Conformances

JIS Z3312 YGW18  
EN ISO 14341-B S18

## Applications

- High tensile welded structure
- Heavy equipment
- Structural fabrication

## Features

- Good performance with high-current
- CO<sub>2</sub> gas
- High efficiency
- Deep penetration

## Welding Position



1G 2F  
(PA) (PB)

## Current

DC +

## Shielding Gas

100% CO<sub>2</sub>

## Diameter / Packaging

Diameter	Spool			Pac		
	5kg (11lbs)	15kg (33lbs)	20kg (44lbs)	250kg (551lbs)	300kg (661lbs)	350kg (771lbs)
0.8 (0.033)	√	√	√	√	√	√
0.9 (0.035)	√	√	√	√	√	√
1.0 (0.040)	√	√	√	√	√	√
1.2 (0.045)	√	√	√	√	√	√
1.4 (0.052)	√	√	√	√	√	√
1.6 (1/16)	√	√	√	√	√	√

### Typical Chemical Composition of the Wire(%)

C	Si	Mn	P	S	Ti
0.07	0.89	1.95	0.013	0.007	0.18

### Typical Mechanical Properties of All-Weld Metal

	YS MPa(lbs/in <sup>2</sup> )	TS MPa(lbs/in <sup>2</sup> )	EL (%)	Temp °C(°F)	CVN-Impact Value J (ft.-lbs)
As welded with 100% CO <sub>2</sub>	550 (79,800)	630 (91,500)	28	0 (32)	110 (81)

### Typical Operating Procedures

Diameter, Polarity Shielding Gas	CTWD mm(in)	Wire Feed Speed m/min (in/min)	Voltage (volts)	Approx. Current (amps)	Melt-Off Rate kg/hr (lb/hr)
<b>1.2mm (0.045in), DC +</b>					
100% CO <sub>2</sub> Gas	20 (3/4)	14.5 (570)	31	280	7.3 (16.1)
		17.0 (670)	34	320	8.6 (19.0)
		21.0 (830)	37	350	10.6 (23.3)
<b>1.4mm (0.052in), DC +</b>					
100% CO <sub>2</sub> Gas	20 (3/4)	12.0 (472)	34	300	8.3 (18.3)
		14.6 (575)	36	340	10.1 (22.2)
		15.8 (622)	39	360	11.0 (24.2)
<b>1.6mm (1/16in), DC +</b>					
100% CO <sub>2</sub> Gas	20 (3/4)	9.4 (370)	37	340	8.5 (18.7)
		11.7 (460)	43	390	10.6 (23.3)
		12.2 (480)	44	400	11.1 (24.4)

# SM-80G

High tensile steels

## Conformances

AWS A5.28/ ASME SFA5.28 ER80S-G  
JIS Z3312 G 59J A 1 U C 3M1T  
EN ISO 14341-B S3M1T  
ABS AWS A5.28 ER80S-G (-20°C ≥47J)

## Applications

- High tensile welded structure
- Pressure vessels
- Machinery

## Features

- High deposition rate
- Special alloying elements added
- Stable arc with high current

## Welding Position



1G 2F  
(PA) (PB)

## Current

DC +

## Shielding Gas

100% CO<sub>2</sub>  
Ar + 20~25% CO<sub>2</sub>

## Diameter / Packaging

Diameter	Spool			Pac		
	5kg (11lbs)	15kg (33lbs)	20kg (44lbs)	250kg (551lbs)	300kg (661lbs)	350kg (771lbs)
0.8 (0.033)	✓	✓	✓	✓	✓	✓
0.9 (0.035)	✓	✓	✓	✓	✓	✓
1.0 (0.040)	✓	✓	✓	✓	✓	✓
1.2 (0.045)	✓	✓	✓	✓	✓	✓
1.4 (0.052)	✓	✓	✓	✓	✓	✓
1.6 (1/16)	✓	✓	✓	✓	✓	✓

### Typical Chemical Composition of the Wire(%)

C	Si	Mn	P	S	Mo	Ti
0.06	0.81	1.85	0.013	0.007	0.27	0.15

### Typical Mechanical Properties of All-Weld Metal

	YS MPa(lbs/in <sup>2</sup> )	TS MPa(lbs/in <sup>2</sup> )	EL (%)	Temp °C(°F)	CVN-Impact Value J (ft.-lbs)
As welded with 100% CO <sub>2</sub>	571 (77,100)	645 (93,500)	26.6	-20 (-4)	117 (86)
As welded with 80% Ar + CO <sub>2</sub>	651 (94,400)	715 (103,600)	25.6	-20 (-4)	72 (53)
As welded with 90% Ar + CO <sub>2</sub>	668 (96,800)	732 (106,140)	22.8	-20 (-4)	65 (48)

### Typical Operating Procedures

Diameter, Polarity Shielding Gas	CTWD mm(in)	Wire Feed Speed m/min (in/min)	Voltage (volts)	Approx. Current (amps)	Melt-Off Rate kg/hr (lb/hr)
<b>1.2mm (0.045in), DC +</b>					
100% CO <sub>2</sub> Gas	20 (3/4)	14.5 (570)	31	280	7.3 (16.1)
		17.0 (670)	34	320	8.6 (19.0)
		21.0 (830)	37	350	10.6 (23.3)
Mixed Gas (Ar + CO <sub>2</sub> )	20 (3/4)	11.2 (440)	30	280	5.6 (12.3)
		12.8 (503)	33	320	6.5 (14.3)
		14.0 (551)	36	350	7.1 (15.7)
<b>1.4mm (0.052in), DC +</b>					
100% CO <sub>2</sub> Gas	20 (3/4)	12.0 (472)	34	300	8.3 (18.3)
		14.6 (575)	36	340	10.1 (22.2)
		15.8 (622)	39	360	11.0 (24.2)
Mixed Gas (Ar + CO <sub>2</sub> )	20 (3/4)	8.7 (343)	32	300	6.0 (13.2)
		9.5 (374)	34	340	6.6 (14.5)
		10.0 (394)	35	360	6.9 (15.3)
<b>1.6mm (1/16in), DC +</b>					
100% CO <sub>2</sub> Gas	20 (3/4)	9.4 (370)	37	340	8.5 (18.7)
		11.7 (460)	43	390	10.6 (23.3)
		12.2 (480)	44	400	11.1 (24.4)
Mixed Gas (Ar + CO <sub>2</sub> )	20 (3/4)	6.6 (260)	34	340	6.0 (13.2)
		8.2 (322)	38	390	7.4 (16.3)
		8.6 (339)	38	400	7.8 (17.2)

# SM-100

High tensile steels

## Conformances

AWS A5.28/ ASME SFA5.28 ER100S-G

## Applications

- 0.3Cr-1.7Ni-0.25Mo-alloyed, High strength steel

## Features

- Good TS and impact value at low temperature
- Stable arc with high-current
- Low spatter

## Welding Position



1G 2F  
(PA) (PB)

## Current

DC +

## Shielding Gas

Ar + 20~25% CO<sub>2</sub>

## Diameter / Packaging

Diameter	Spool			Pac		
	5kg (11lbs)	15kg (33lbs)	20kg (44lbs)	250kg (551lbs)	300kg (661lbs)	350kg (771lbs)
0.8 (0.033)	√	√	√	√	√	√
0.9 (0.035)	√	√	√	√	√	√
1.0 (0.040)	√	√	√	√	√	√
1.2 (0.045)	√	√	√	√	√	√
1.4 (0.052)	√	√	√	√	√	√
1.6 (1/16)	√	√	√	√	√	√

### Typical Chemical Composition of the Wire(%)

C	Si	Mn	P	S	Cr	Ni	Mo
0.081	0.48	1.76	0.013	0.012	0.28	1.76	0.23

### Typical Mechanical Properties of All-Weld Metal

	YS MPa(lbs/in <sup>2</sup> )	TS MPa(lbs/in <sup>2</sup> )	EL (%)	Temp °C(°F)	CVN-Impact Value J (ft.-lbs)
As welded with 80% Ar + CO <sub>2</sub>	711 (103,100)	756 (109,600)	20.4	-20 (-4) -40 (-40)	114 (84) 83 (61)
As welded with 90% Ar + CO <sub>2</sub>	724 (105,000)	766 (111,100)	18.9	-20 (-4) -40 (-40)	106 (79) 78 (57)

### Typical Operating Procedures

Diameter, Polarity Shielding Gas	CTWD mm(in)	Wire Feed Speed m/min (in/min)	Voltage (volts)	Approx. Current (amps)	Melt-Off Rate kg/hr (lb/hr)
<b>1.2mm (0.045in), DC +</b>					
Mixed Gas (Ar + CO <sub>2</sub> )	20 (3/4)	11.2 (440)	30	280	5.6 (12.3)
		12.8 (503)	33	320	6.5 (14.3)
		14.0 (551)	36	350	7.1 (15.7)
<b>1.4mm (0.052in), DC +</b>					
Mixed Gas (Ar + CO <sub>2</sub> )	20 (3/4)	8.7 (343)	32	300	6.0 (13.2)
		9.5 (374)	34	340	6.6 (14.5)
		10.0 (394)	35	360	6.9 (15.3)
<b>1.6mm (1/16in), DC +</b>					
Mixed Gas (Ar + CO <sub>2</sub> )	20 (3/4)	6.6 (260)	34	340	6.0 (13.2)
		8.2 (322)	38	390	7.4 (16.3)
		8.6 (339)	38	400	7.8 (17.2)

SMAW

SAW

GMAW

GTAW

FCAW

Non-FERROUS

APPENDIX

# SM-110

High tensile steels

## Conformances

AWS A5.28/ ASME SFA5.28 ER110S-G

## Applications

- 0.3Cr-1.9Ni-0.5Mo-alloyed, High strength steel

## Features

- Good TS and impact value at low temperature
- Stable arc with high-current
- Low spatter

## Welding Position



1G 2F  
(PA) (PB)

## Current

DC +

## Shielding Gas

Ar + 20~25% CO<sub>2</sub>

## Diameter / Packaging

Diameter	Spool			Pac		
	5kg (11lbs)	15kg (33lbs)	20kg (44lbs)	250kg (551lbs)	300kg (661lbs)	350kg (771lbs)
0.8 (0.033)	√	√	√	√	√	√
0.9 (0.035)	√	√	√	√	√	√
1.0 (0.040)	√	√	√	√	√	√
1.2 (0.045)	√	√	√	√	√	√
1.4 (0.052)	√	√	√	√	√	√
1.6 (1/16)	√	√	√	√	√	√



### Typical Chemical Composition of the Wire(%)

C	Si	Mn	P	S	Cr	Ni	Mo
0.089	0.75	1.83	0.011	0.012	0.30	1.9	0.52

### Typical Mechanical Properties of All-Weld Metal

	YS MPa(lbs/in <sup>2</sup> )	TS MPa(lbs/in <sup>2</sup> )	EL (%)	Temp °C(°F)	CVN-Impact Value J (ft.-lbs)
As welded with 80% Ar + CO <sub>2</sub>	700 (103,000)	858 (124,400)	19.4	-40 (-40) 60 (-76)	82 (60) 69 (51)
As welded with 90% Ar + CO <sub>2</sub>	725 (105,100)	871 (126,300)	17.2	-40 (-40) 60 (-76)	71 (53) 60 (45)

### Typical Operating Procedures

Diameter, Polarity Shielding Gas	CTWD mm(in)	Wire Feed Speed m/min (in/min)	Voltage (volts)	Approx. Current (amps)	Melt-Off Rate kg/hr (lb/hr)
<b>1.2mm (0.045in), DC +</b>					
Mixed Gas (Ar + CO <sub>2</sub> )	20 (3/4)	11.2 (440)	30	280	5.6 (12.3)
		12.8 (503)	33	320	6.5 (14.3)
		14.0 (551)	36	350	7.1 (15.7)
<b>1.4mm (0.052in), DC +</b>					
Mixed Gas (Ar + CO <sub>2</sub> )	20 (3/4)	8.7 (343)	32	300	6.0 (13.2)
		9.5 (374)	34	340	6.6 (14.5)
		10.0 (394)	35	360	6.9 (15.3)
<b>1.6mm (1/16in), DC +</b>					
Mixed Gas (Ar + CO <sub>2</sub> )	20 (3/4)	6.6 (260)	34	340	6.0 (13.2)
		8.2 (322)	38	390	7.4 (16.3)
		8.6 (339)	38	400	7.8 (17.2)

SMAW

SAW

GMAW

GTAW

FCAW

Non-FERROUS

APPENDIX

# SM-80CM

Heat resistance – low alloy steel

## Conformances

AWS A5.28/ ASME SFA5.28 ER80S-G

JIS Z3317 YG1CM-A

EN ISO 14341-B S2M3

## Applications

- Structural fabrication
- Offshore structure
- Pressure vessels
- Machinery
- Chemical industry

## Features

- MIG welding for boiler steam pipe of Steam power generation and 1.0~1.25%Cr-0.5%Mo heat resisting steel using for refining oil & chemical industrial machine tool.
- Good TS and Impact value in a high temperature after heat treatment.

## Welding Position



1G 2F  
(PA) (PB)

## Current

DC +

## Shielding Gas

100% Ar  
Ar + 2% O<sub>2</sub>

## Diameter / Packaging

Diameter	Spool			Pac		
	5kg (11lbs)	15kg (33lbs)	20kg (44lbs)	250kg (551lbs)	300kg (661lbs)	350kg (771lbs)
0.8 (0.033)	✓	✓	✓	✓	✓	✓
0.9 (0.035)	✓	✓	✓	✓	✓	✓
1.0 (0.040)	✓	✓	✓	✓	✓	✓
1.2 (0.045)	✓	✓	✓	✓	✓	✓
1.4 (0.052)	✓	✓	✓	✓	✓	✓
1.6 (1/16)	✓	✓	✓	✓	✓	✓

**Typical Chemical Composition of the Wire(%)**

C	Si	Mn	Cr	Mo
0.09	0.67	1.02	1.19	0.45

**Typical Mechanical Properties of All-Weld Metal**

	YS MPa(lbs/in <sup>2</sup> )	EL (%)	Temp °C(°F)	CVN-Impact Value J (ft.-lbs)
As welded with 100% Ar	630 (91,500)	27	0 (32) -20 (-4)	140 (103) 120 (88)
As welded with Ar + 2% O <sub>2</sub>	680 (98,000)	23	0 (32) -20 (-4)	140 (103) 115 (85)

**Typical Operating Procedures**

Diameter, Polarity Shielding Gas	CTWD mm(in)	Wire Feed Speed m/min (in/min)	Voltage (volts)	Approx. Current (amps)	Melt-Off Rate kg/hr (lb/hr)
<b>1.2mm (0.045in), DC +</b>					
Ar + 2% O <sub>2</sub>	20 (3/4)	4.5 (177)	16	150	2.3 (5.1)
		7.7 (303)	22	200	3.9 (8.6)
		11.7 (460)	29	280	5.9 (13.0)
<b>1.4mm (0.052in), DC +</b>					
Ar + 2% O <sub>2</sub>	20 (3/4)	7.2 (283)	30	300	5.0 (11.0)
		8.6 (339)	32	340	6.0 (13.2)
		9.5 (374)	33	360	6.6 (14.5)
<b>1.6mm (1/16in), DC +</b>					
Ar + 2% O <sub>2</sub>	20 (3/4)	7.7 (303)	32	340	7.7 (15.4)
		10.2 (402)	36	390	9.3 (20.5)
		10.8 (425)	37	400	9.8 (21.6)

SMW

SAW

GMAW

GTAW

FCAW

Non-FERROUS

APPENDIX

# SM-307Si

STS 304 & high Mn steels

## Conformances

EN ISO 14343-A G 18 8 Mn

## Applications

- Structural fabrication
- Automotive
- Machinery

## Features

- Good resistance to crack and corrosion
- High efficiency

## Welding Position



1G 2F 3G 4G  
(PA) (PB) (PF-PG) (PE)

## Current

DC +

## Shielding Gas

Ar / Ar + O<sub>2</sub>

## Diameter / Packaging

Diameter	Spool			Pac		
	12.5kg (28lbs)	15kg (33 lbs)	20kg (44lbs)	150kg (330lbs)	200kg (440lbs)	250kg (551lbs)
mm (in)						
0.8 (0.033)	✓					
0.9 (0.035)	✓					
1.0 (0.040)	✓					
1.2 (0.045)	✓					
1.4 (0.052)						✓
1.6 (1/16)	✓					

**Typical Chemical Composition of the Wire(%)**

C	Si	Mn	Cr	Ni	Mo
0.08	0.87	7.17	19.6	9.3	0.12

**Typical Mechanical Properties of All-Weld Metal**

TS MPa(lbs/in <sup>2</sup> )	EL (%)	Temp °C(°F)	CVN-Impact Value J (ft.-lbs)	PWHT
610 (88,600)	42	0 (32) -20 (-4)	83 (63) 59 (43)	690°C × 1Hr

**Typical Operating Procedures**

Diameter, Polarity Shielding Gas	CTWD mm(in)	Wire Feed Speed m/min (in/min)	Voltage (volts)	Approx. Current (amps)	Melt-Off Rate kg/hr (lb/hr)
<b>1.0mm (0.040 in), DC +</b>					
100% Ar Gas	15~20 (0.59~0.78)	6.0 (236)	24	140	2.1 (4.6)
		7.1 (280)	24	160	2.5 (5.5)
		9.2 (362)	24	190	3.2 (7.1)
Mixed Gas (Ar + 2% O <sub>2</sub> )	15~20 (0.59~0.78)	5.2 (204)	26	160	1.8 (4.0)
		7.0 (276)	26	190	2.4 (5.3)
		8.3 (327)	26	220	2.9 (6.4)
<b>1.2mm (0.045 in), DC +</b>					
100% Ar Gas	15~20 (0.59~0.78)	9.2 (362)	27	190	4.6 (10.1)
		11.9 (469)	27	220	6.0 (13.2)
		15.5 (610)	27	260	7.8 (17.2)
Mixed Gas (Ar + 2% O <sub>2</sub> )	15~20 (0.59~0.78)	7.7 (303)	28	200	3.9 (8.6)
		8.6 (339)	28	230	4.3 (9.5)
		10.1 (398)	28	260	5.1 (11.2)

SMW

SAW

GMW

GTAW

FCAW

Non-FERROUS

APPENDIX

# SM-308

Stainless steel

## Conformances

AWS A5.9/ ASME SFA5.9 ER308

JIS Z3321 YS308

EN ISO 14343-A G 19 9

## Applications

- Structural fabrication
- Petrochemical
- Oil and textile industries
- Nuclear reactor

## Features

- Good resistance to crack and corrosion
- High efficiency

## Welding Position



1G 2F 3G 4G  
(PA) (PB) (PF-PG) (PE)

## Current

DC +

## Shielding Gas

Ar / Ar + O<sub>2</sub>

## Diameter / Packaging

Diameter	Spool			Pac			
	mm (in)	12.5kg (28lbs)	15kg (33 lbs)	20kg (44lbs)	150kg (330lbs)	200kg (440lbs)	250kg (551lbs)
0.8 (0.033)	✓						
0.9 (0.035)	✓						
1.0 (0.040)	✓						
1.2 (0.045)	✓					✓	
1.4 (0.052)							
1.6 (1/16)	✓						

### Typical Chemical Composition of the Wire(%)

C	Si	Mn	Cr	Ni
0.04	0.41	1.65	19.9	9.8

### Typical Mechanical Properties of All-Weld Metal

TS MPa(lbs/in <sup>2</sup> )	EL (%)	Temp °C(°F)	CVN-Impact Value J (ft-lbs)
590 (85,600)	40	0 (32) -20 (-4)	100 (74) 50 (37)

### Typical Operating Procedures

Diameter, Polarity Shielding Gas	CTWD mm(in)	Wire Feed Speed m/min (in/min)	Voltage (volts)	Approx. Current (amps)	Melt-Off Rate kg/hr (lb/hr)
<b>1.0mm (0.040 in), DC +</b>					
100% Ar Gas	15~20 (0.59~0.78)	6.0 (236)	24	140	2.1 (4.6)
		7.1 (280)	24	160	2.5 (5.5)
		9.2 (362)	24	190	3.2 (7.1)
Mixed Gas (Ar + 2% O <sub>2</sub> )	15~20 (0.59~0.78)	5.2 (204)	26	160	1.8 (4.0)
		7.0 (276)	26	190	2.4 (5.3)
		8.3 (327)	26	220	2.9 (6.4)
<b>1.2mm (0.045 in), DC +</b>					
100% Ar Gas	15~20 (0.59~0.78)	9.2 (362)	27	190	4.6 (10.1)
		11.9 (469)	27	220	6.0 (13.2)
		15.5 (610)	27	260	7.8 (17.2)
Mixed Gas (Ar + 2% O <sub>2</sub> )	15~20 (0.59~0.78)	7.7 (303)	28	200	3.9 (8.6)
		8.6 (339)	28	230	4.3 (9.5)
		10.1 (398)	28	260	5.1 (11.2)

# SM-308L

Low carbon 18%Cr-8%Ni steel

## Conformances

AWS A5.9/ ASME SFA5.9 ER308L

JIS Z3321 YS308L

EN ISO 14343-A G 19 9L

## Applications

- Structural fabrication
- Petrochemical
- Oil and textile industries
- Nuclear reactor

## Features

- Good resistance to crack and corrosion
- High efficiency

## Welding Position



1G 2F 3G 4G  
(PA) (PB) (PF-PG) (PE)

## Current

DC +

## Shielding Gas

Ar / Ar + O<sub>2</sub>

## Diameter / Packaging

Diameter	Spool			Pac		
	12.5kg (28lbs)	15kg (33 lbs)	20kg (44lbs)	150kg (330lbs)	200kg (440lbs)	250kg (551lbs)
mm (in)						
0.8 (0.033)	✓					
0.9 (0.035)	✓					
1.0 (0.040)	✓	✓				
1.2 (0.045)	✓	✓				
1.4 (0.052)						✓
1.6 (1/16)	✓					✓



**Typical Chemical Composition of the Wire(%)**

C	Si	Mn	Cr	Ni
0.02	0.35	1.60	19.9	10.1

**Typical Mechanical Properties of All-Weld Metal**

TS MPa(lbs/in <sup>2</sup> )	EL (%)	Temp °C(°F)	CVN-Impact Value J (ft.lbs)
560 (81,300)	42	0 (32) -20 (-4)	90 (66) 50 (37)

**Typical Operating Procedures**

Diameter, Polarity Shielding Gas	CTWD mm(in)	Wire Feed Speed m/min (in/min)	Voltage (volts)	Approx. Current (amps)	Melt-Off Rate kg/hr (lb/hr)
<b>1.0mm (0.040 in), DC +</b>					
100% Ar Gas	15~20 (0.59~0.78)	6.0 (236)	24	140	2.1 (4.6)
		7.1 (280)	24	160	2.5 (5.5)
		9.2 (362)	24	190	3.2 (7.1)
Mixed Gas (Ar + 2% O <sub>2</sub> )	15~20 (0.59~0.78)	5.2 (204)	26	160	1.8 (4.0)
		7.0 (276)	26	190	2.4 (5.3)
		8.3 (327)	26	220	2.9 (6.4)
<b>1.2mm (0.045 in), DC +</b>					
100% Ar Gas	15~20 (0.59~0.78)	9.2 (362)	27	190	4.6 (10.1)
		11.9 (469)	27	220	6.0 (13.2)
		15.5 (610)	27	260	7.8 (17.2)
Mixed Gas (Ar + 2% O <sub>2</sub> )	15~20 (0.59~0.78)	7.7 (303)	28	200	3.9 (8.6)
		8.6 (339)	28	230	4.3 (9.5)
		10.1 (398)	28	260	5.1 (11.2)

SWAW

SAW

GMAW

GTAW

FCAW

Non-FERROUS

APPENDIX

# SM-308LSi

Low carbon 18%Cr-8%Ni steel

## Conformances

AWS A5.9/ ASME SFA5.9 ER308LSi

JIS Z3321 YS308LSi

EN ISO 14343-A G 19 9L Si

## Applications

- Structural fabrication
- Petrochemical
- Oil and textile industries
- Nuclear reactor

## Features

- Good resistance to crack and corrosion
- High efficiency
- Good arc stability and bead wetting

## Welding Position



1G 2F 3G 4G  
(PA) (PB) (PF-PG) (PE)

## Current

DC +

## Shielding Gas

Ar / Ar + O<sub>2</sub>

## Diameter / Packaging

Diameter	Spool			Pac			
	mm (in)	12.5kg (28lbs)	15kg (33 lbs)	20kg (44lbs)	150kg (330lbs)	200kg (440lbs)	250kg (551lbs)
0.8 (0.033)	✓						
0.9 (0.035)	✓						
1.0 (0.040)	✓						
1.2 (0.045)	✓					✓	
1.4 (0.052)							
1.6 (1/16)	✓						

### Typical Chemical Composition of the Wire(%)

C	Si	Mn	Cr	Ni	Mo
0.027	0.79	1.96	20.78	10.02	0.1

### Typical Mechanical Properties of All-Weld Metal

TS MPa(lbs/in <sup>2</sup> )	EL (%)
610 (88,500)	40.4

### Typical Operating Procedures

Diameter, Polarity Shielding Gas	CTWD mm(in)	Wire Feed Speed m/min (in/min)	Voltage (volts)	Approx. Current (amps)	Melt-Off Rate kg/hr (lb/hr)
<b>1.0mm (0.040 in), DC +</b>					
100% Ar Gas	15~20 (0.59~0.78)	6.0 (236)	24	140	2.1 (4.6)
		7.1 (280)	24	160	2.5 (5.5)
		9.2 (362)	24	190	3.2 (7.1)
Mixed Gas (Ar + 2% O <sub>2</sub> )	15~20 (0.59~0.78)	5.2 (204)	26	160	1.8 (4.0)
		7.0 (276)	26	190	2.4 (5.3)
		8.3 (327)	26	220	2.9 (6.4)
<b>1.2mm (0.045 in), DC +</b>					
100% Ar Gas	15~20 (0.59~0.78)	9.2 (362)	27	190	4.6 (10.1)
		11.9 (469)	27	220	6.0 (13.2)
		15.5 (610)	27	260	7.8 (17.2)
Mixed Gas (Ar + 2% O <sub>2</sub> )	15~20 (0.59~0.78)	7.7 (303)	28	200	3.9 (8.6)
		8.6 (339)	28	230	4.3 (9.5)
		10.1 (398)	28	260	5.1 (11.2)

# SM-309

22%Cr-12%Ni steel, 18%Cr-8%Ni clad steel, STS-CrMo, STS-Carbon steel

## Conformances

AWS A5.9/ ASME SFA5.9 ER309

JIS Z3321 YS309

EN ISO 14343-A G 23 12

## Applications

- Structural fabrication
- Petrochemical
- Oil and textile industries
- Nuclear reactor

## Features

- Good resistance to crack and heat
- High efficiency

## Welding Position



1G 2F 3G 4G  
(PA) (PB) (PF-PG) (PE)

## Current

DC +

## Shielding Gas

Ar / Ar + O<sub>2</sub>

## Diameter / Packaging

Diameter mm (in)	Spool			Pac		
	12.5kg (28lbs)	15kg (33 lbs)	20kg (44lbs)	150kg (330lbs)	200kg (440lbs)	250kg (551lbs)
0.8 (0.033)	√					
0.9 (0.035)	√					
1.0 (0.040)	√		√		√	√
1.2 (0.045)	√				√	
1.4 (0.052)						
1.6 (1/16)	√					

### Typical Chemical Composition of the Wire(%)

C	Si	Mn	Cr	Ni
0.09	0.39	1.60	23.5	12.8

### Typical Mechanical Properties of All-Weld Metal

TS MPa(lbs/in <sup>2</sup> )	EL (%)
660 (95,700)	36

### Typical Operating Procedures

Diameter, Polarity Shielding Gas	CTWD mm(in)	Wire Feed Speed m/min (in/min)	Voltage (volts)	Approx. Current (amps)	Melt-Off Rate kg/hr (lb/hr)
<b>1.0mm (0.040 in), DC +</b>					
100% Ar Gas	15~20 (0.59~0.78)	6.0 (236)	24	140	2.1 (4.6)
		7.1 (280)	24	160	2.5 (5.5)
		9.2 (362)	24	190	3.2 (7.1)
Mixed Gas (Ar + 2% O <sub>2</sub> )	15~20 (0.59~0.78)	5.2 (204)	26	160	1.8 (4.0)
		7.0 (276)	26	190	2.4 (5.3)
		8.3 (327)	26	220	2.9 (6.4)
<b>1.2mm (0.045 in), DC +</b>					
100% Ar Gas	15~20 (0.59~0.78)	9.2 (362)	27	190	4.6 (10.1)
		11.9 (469)	27	220	6.0 (13.2)
		15.5 (610)	27	260	7.8 (17.2)
Mixed Gas (Ar + 2% O <sub>2</sub> )	15~20 (0.59~0.78)	7.7 (303)	28	200	3.9 (8.6)
		8.6 (339)	28	230	4.3 (9.5)
		10.1 (398)	28	260	5.1 (11.2)

SMAW

SAW

GMAW

GTAW

FCAW

Non-FERROUS

APPENDIX

# SM-309L

22%Cr-12%Ni steel, 18%Cr-8%Ni clad steel, STS-CrMo, STS-Carbon steel

## Conformances

AWS A5.9/ ASME SFA5.9 ER309L

JIS Z3321 YS309L

EN ISO 14343-A G 23 12L

## Applications

- Structural fabrication
- Petrochemical
- Oil and textile industries
- Nuclear reactor

## Features

- Good resistance to crack and heat
- High efficiency

## Welding Position



1G 2F 3G 4G  
(PA) (PB) (PF-PG) (PE)

## Current

DC +

## Shielding Gas

Ar / Ar + O<sub>2</sub>

## Diameter / Packaging

Diameter	Spool			Pac		
	5kg (11lbs)	12.5kg (28lbs)	15kg (33 lbs)	150kg (330lbs)	200kg (440lbs)	250kg (551lbs)
mm (in)						
0.8 (0.033)		√				
0.9 (0.035)		√				
1.0 (0.040)		√				
1.2 (0.045)	√	√		√		
1.4 (0.052)						
1.6 (1/16)		√				

### Typical Chemical Composition of the Wire(%)

C	Si	Mn	Cr	Ni
0.03	0.41	1.58	23.5	12.8

### Typical Mechanical Properties of All-Weld Metal

TS MPa(lbs/in <sup>2</sup> )	EL (%)
640 (92,900)	38

### Typical Operating Procedures

Diameter, Polarity Shielding Gas	CTWD mm(in)	Wire Feed Speed m/min (in/min)	Voltage (volts)	Approx. Current (amps)	Melt-Off Rate kg/hr (lb/hr)
<b>1.0mm (0.040 in), DC +</b>					
100% Ar Gas	15~20 (0.59~0.78)	6.0 (236)	24	140	2.1 (4.6)
		7.1 (280)	24	160	2.5 (5.5)
		9.2 (362)	24	190	3.2 (7.1)
Mixed Gas (Ar + 2% O <sub>2</sub> )	15~20 (0.59~0.78)	5.2 (204)	26	160	1.8 (4.0)
		7.0 (276)	26	190	2.4 (5.3)
		8.3 (327)	26	220	2.9 (6.4)
<b>1.2mm (0.045 in), DC +</b>					
100% Ar Gas	15~20 (0.59~0.78)	9.2 (362)	27	190	4.6 (10.1)
		11.9 (469)	27	220	6.0 (13.2)
		15.5 (610)	27	260	7.8 (17.2)
Mixed Gas (Ar + 2% O <sub>2</sub> )	15~20 (0.59~0.78)	7.7 (303)	28	200	3.9 (8.6)
		8.6 (339)	28	230	4.3 (9.5)
		10.1 (398)	28	260	5.1 (11.2)

# SM-309LSi

22%Cr-12%Ni steel, 18%Cr-8%Ni clad steel, STS-CrMo, STS-Carbon steel

## Conformances

AWS A5.9/ ASME SFA5.9 ER309LSi

JIS Z3321 YS309LSi

EN ISO 14343-A G 23 12L Si

## Applications

- Structural fabrication
- Petrochemical
- Oil and textile industries
- Nuclear reactor

## Features

- Good resistance to crack and corrosion
- High efficiency
- Good arc stability and bead wetting

## Welding Position



1G 2F 3G 4G  
(PA) (PB) (PF-PG) (PE)

## Current

DC +

## Shielding Gas

Ar / Ar + O<sub>2</sub>

## Diameter / Packaging

Diameter	Spool			Pac			
	mm (in)	12.5kg (28lbs)	15kg (33 lbs)	20kg (44lbs)	150kg (330lbs)	200kg (440lbs)	250kg (551lbs)
0.8 (0.033)	✓						
0.9 (0.035)	✓						
1.0 (0.040)	✓						
1.2 (0.045)	✓				✓		
1.4 (0.052)							
1.6 (1/16)	✓						



**Typical Chemical Composition of the Wire(%)**

C	Si	Mn	Cr	Ni	Mo
0.022	0.79	1.61	24.11	13.97	0.1

**Typical Mechanical Properties of All-Weld Metal**

TS MPa(lbs/in <sup>2</sup> )	EL (%)
571 (82,800)	40.2

**Typical Operating Procedures**

Diameter, Polarity Shielding Gas	CTWD mm(in)	Wire Feed Speed m/min (in/min)	Voltage (volts)	Approx. Current (amps)	Melt-Off Rate kg/hr (lb/hr)
<b>1.0mm (0.040 in), DC +</b>					
100% Ar Gas	15~20 (0.59~0.78)	6.0 (236)	24	140	2.1 (4.6)
		7.1 (280)	24	160	2.5 (5.5)
		9.2 (362)	24	190	3.2 (7.1)
Mixed Gas (Ar + 2% O <sub>2</sub> )	15~20 (0.59~0.78)	5.2 (204)	26	160	1.8 (4.0)
		7.0 (276)	26	190	2.4 (5.3)
		8.3 (327)	26	220	2.9 (6.4)
<b>1.2mm (0.045 in), DC +</b>					
100% Ar Gas	15~20 (0.59~0.78)	9.2 (362)	27	190	4.6 (10.1)
		11.9 (469)	27	220	6.0 (13.2)
		15.5 (610)	27	260	7.8 (17.2)
Mixed Gas (Ar + 2% O <sub>2</sub> )	15~20 (0.59~0.78)	7.7 (303)	28	200	3.9 (8.6)
		8.6 (339)	28	230	4.3 (9.5)
		10.1 (398)	28	260	5.1 (11.2)

SMW

SAW

GMW

GTAW

FCAW

Non-FERROUS

APPENDIX

# SM-309MoL

Dissimilar metals such as stainless steels and carbon steels

## Conformances

AWS A5.9/ ASME SFA5.9 ER309LMo

JIS Z3321 YS309LMo

EN ISO 14343-A G 23 12 2L

## Applications

- STS clad steel (316, 316L)

## Features

- Good resistance to crack and corrosion
- High efficiency
- Good arc stability and bead wetting

## Welding Position



1G 2F 3G 4G  
(PA) (PB) (PF-PG) (PE)

## Current

DC +

## Shielding Gas

Ar / Ar + O<sub>2</sub>

## Diameter / Packaging

Diameter	Spool			Pac		
	12.5kg (28lbs)	15kg (33 lbs)	20kg (44lbs)	150kg (330lbs)	200kg (440lbs)	250kg (551lbs)
mm (in)						
0.8 (0.033)	√					
0.9 (0.035)	√					
1.0 (0.040)	√					
1.2 (0.045)	√					
1.4 (0.052)						
1.6 (1/16)	√					

**Typical Chemical Composition of the Wire(%)**

C	Si	Mn	Cr	Ni	Mo
0.01	0.35	1.8	23.2	13.7	2.5

**Typical Mechanical Properties of All-Weld Metal**

TS MPa(lbs/in <sup>2</sup> )	EL (%)
660 (95,700)	34

**Typical Operating Procedures**

Diameter, Polarity Shielding Gas	CTWD mm(in)	Wire Feed Speed m/min (in/min)	Voltage (volts)	Approx. Current (amps)	Melt-Off Rate kg/hr (lb/hr)
<b>1.0mm (0.040 in), DC +</b>					
100% Ar Gas	15~20 (0.59~0.78)	6.0 (236)	24	140	2.1 (4.6)
		7.1 (280)	24	160	2.5 (5.5)
		9.2 (362)	24	190	3.2 (7.1)
Mixed Gas (Ar + 2% O <sub>2</sub> )	15~20 (0.59~0.78)	5.2 (204)	26	160	1.8 (4.0)
		7.0 (276)	26	190	2.4 (5.3)
		8.3 (327)	26	220	2.9 (6.4)
<b>1.2mm (0.045 in), DC +</b>					
100% Ar Gas	15~20 (0.59~0.78)	9.2 (362)	27	190	4.6 (10.1)
		11.9 (469)	27	220	6.0 (13.2)
		15.5 (610)	27	260	7.8 (17.2)
Mixed Gas (Ar + 2% O <sub>2</sub> )	15~20 (0.59~0.78)	7.7 (303)	28	200	3.9 (8.6)
		8.6 (339)	28	230	4.3 (9.5)
		10.1 (398)	28	260	5.1 (11.2)

SMW

SAW

GMW

GTAW

FCAW

Non-FERROUS

APPENDIX

# SM-310

25%Cr-20%Ni STS

## Conformances

AWS AWS A5.9/ ASME SFA5.9 ER310

JIS Z3321 YS310

EN ISO 14343-A G 25 20

## Applications

- STS clad steel

## Features

- Good resistance to crack and corrosion
- High efficiency
- Good arc stability and bead wetting

## Welding Position



1G 2F 3G 4G  
(PA) (PB) (PF-PG) (PE)

## Current

DC +

## Shielding Gas

Ar / Ar + O<sub>2</sub>

## Diameter / Packaging

Diameter	Spool			Pac		
	12.5kg (28lbs)	15kg (33 lbs)	20kg (44lbs)	150kg (330lbs)	200kg (440lbs)	250kg (551lbs)
mm (in)						
0.8 (0.033)	√					
0.9 (0.035)	√					
1.0 (0.040)	√					
1.2 (0.045)	√					
1.4 (0.052)						
1.6 (1/16)	√					

### Typical Chemical Composition of the Wire(%)

C	Si	Mn	Cr	Ni
0.09	0.35	1.90	26.8	20.9

### Typical Mechanical Properties of All-Weld Metal

TS MPa(lbs/in <sup>2</sup> )	EL (%)
610 (88,500)	40

### Typical Operating Procedures

Diameter, Polarity Shielding Gas	CTWD mm(in)	Wire Feed Speed m/min (in/min)	Voltage (volts)	Approx. Current (amps)	Melt-Off Rate kg/hr (lb/hr)
<b>1.0mm (0.040 in), DC +</b>					
100% Ar Gas	15~20 (0.59~0.78)	6.0 (236)	24	140	2.1 (4.6)
		7.1 (280)	24	160	2.5 (5.5)
		9.2 (362)	24	190	3.2 (7.1)
Mixed Gas (Ar + 2% O <sub>2</sub> )	15~20 (0.59~0.78)	5.2 (204)	26	160	1.8 (4.0)
		7.0 (276)	26	190	2.4 (5.3)
		8.3 (327)	26	220	2.9 (6.4)
<b>1.2mm (0.045 in), DC +</b>					
100% Ar Gas	15~20 (0.59~0.78)	9.2 (362)	27	190	4.6 (10.1)
		11.9 (469)	27	220	6.0 (13.2)
		15.5 (610)	27	260	7.8 (17.2)
Mixed Gas (Ar + 2% O <sub>2</sub> )	15~20 (0.59~0.78)	7.7 (303)	28	200	3.9 (8.6)
		8.6 (339)	28	230	4.3 (9.5)
		10.1 (398)	28	260	5.1 (11.2)

# SM-312

29%Cr-9%Ni STS, joining of dissimilar-metal

## Conformances

AWS A5.9/ ASME SFA5.9 ER312

JIS Z3321 YS312

EN ISO 14343-A G 25 20

## Applications

- Welding of dissimilar-metal STS to ferritic steel or special steel

## Features

- Good resistance to crack and corrosion
- High efficiency
- Good arc stability and bead wetting

## Welding Position



1G 2F 3G 4G  
(PA) (PB) (PF-PG) (PE)

## Current

DC +

## Shielding Gas

Ar / Ar + O<sub>2</sub>

## Diameter / Packaging

Diameter	Spool			Pac		
	12.5kg (28lbs)	15kg (33 lbs)	20kg (44lbs)	150kg (330lbs)	200kg (440lbs)	250kg (551lbs)
mm (in)						
0.8 (0.033)	√					
0.9 (0.035)	√					
1.0 (0.040)	√					
1.2 (0.045)	√					
1.4 (0.052)						
1.6 (1/16)	√					

### Typical Chemical Composition of the Wire(%)

C	Si	Mn	Cr	Ni
0.10	0.38	1.68	30.0	8.8

### Typical Mechanical Properties of All-Weld Metal

TS MPa(lbs/in <sup>2</sup> )	EL (%)
720 (104,400)	32

### Typical Operating Procedures

Diameter, Polarity Shielding Gas	CTWD mm(in)	Wire Feed Speed m/min (in/min)	Voltage (volts)	Approx. Current (amps)	Melt-Off Rate kg/hr (lb/hr)
<b>1.0mm (0.040 in), DC +</b>					
100% Ar Gas	15~20 (0.59~0.78)	6.0 (236)	24	140	2.1 (4.6)
		7.1 (280)	24	160	2.5 (5.5)
		9.2 (362)	24	190	3.2 (7.1)
Mixed Gas (Ar + 2% O <sub>2</sub> )	15~20 (0.59~0.78)	5.2 (204)	26	160	1.8 (4.0)
		7.0 (276)	26	190	2.4 (5.3)
		8.3 (327)	26	220	2.9 (6.4)
<b>1.2mm (0.045 in), DC +</b>					
100% Ar Gas	15~20 (0.59~0.78)	9.2 (362)	27	190	4.6 (10.1)
		11.9 (469)	27	220	6.0 (13.2)
		15.5 (610)	27	260	7.8 (17.2)
Mixed Gas (Ar + 2% O <sub>2</sub> )	15~20 (0.59~0.78)	7.7 (303)	28	200	3.9 (8.6)
		8.6 (339)	28	230	4.3 (9.5)
		10.1 (398)	28	260	5.1 (11.2)

SMAW

SAW

GMAW

GTAW

FCAW

Non-FERROUS

APPENDIX

# SM-316

18%Cr-12%Ni-2%Mo STS

## Conformances

AWS A5.9/ ASME SFA5.9 ER316

JIS Z3321 YS316

EN ISO 14343-A G 19 12 3

## Applications

- Structural fabrication
- Chemical industries
- Nuclear reactors

## Features

- Good resistance to crack and corrosion
- High efficiency
- Good arc stability and bead wetting

## Welding Position



1G 2F 3G 4G  
(PA) (PB) (PF-PG) (PE)

## Current

DC +

## Shielding Gas

Ar / Ar + O<sub>2</sub>

## Diameter / Packaging

Diameter	Spool			Pac		
	12.5kg (28lbs)	15kg (33 lbs)	20kg (44lbs)	150kg (330lbs)	200kg (440lbs)	250kg (551lbs)
mm (in)						
0.8 (0.033)	√					
0.9 (0.035)	√					
1.0 (0.040)	√					
1.2 (0.045)	√					
1.4 (0.052)						
1.6 (1/16)	√					



### Typical Chemical Composition of the Wire(%)

C	Si	Mn	Cr	Ni	Mo
0.06	0.40	1.71	19.4	12.6	2.5

### Typical Mechanical Properties of All-Weld Metal

TS MPa(lbs/in <sup>2</sup> )	EL (%)
580 (84,200)	39

### Typical Operating Procedures

Diameter, Polarity Shielding Gas	CTWD mm(in)	Wire Feed Speed m/min (in/min)	Voltage (volts)	Approx. Current (amps)	Melt-Off Rate kg/hr (lb/hr)
<b>1.0mm (0.040 in), DC +</b>					
100% Ar Gas	15~20 (0.59~0.78)	6.0 (236)	24	140	2.1 (4.6)
		7.1 (280)	24	160	2.5 (5.5)
		9.2 (362)	24	190	3.2 (7.1)
Mixed Gas (Ar + 2% O <sub>2</sub> )	15~20 (0.59~0.78)	5.2 (204)	26	160	1.8 (4.0)
		7.0 (276)	26	190	2.4 (5.3)
		8.3 (327)	26	220	2.9 (6.4)
<b>1.2mm (0.045 in), DC +</b>					
100% Ar Gas	15~20 (0.59~0.78)	9.2 (362)	27	190	4.6 (10.1)
		11.9 (469)	27	220	6.0 (13.2)
		15.5 (610)	27	260	7.8 (17.2)
Mixed Gas (Ar + 2% O <sub>2</sub> )	15~20 (0.59~0.78)	7.7 (303)	28	200	3.9 (8.6)
		8.6 (339)	28	230	4.3 (9.5)
		10.1 (398)	28	260	5.1 (11.2)

# SM-316L

Low carbon 18%Cr-12%Ni-2%Mo STS

## Conformances

AWS A5.9/ ASME SFA5.9 ER316L

JIS Z3321 YS316L

EN ISO 14343-A G 19 12 3L

## Applications

- Structural fabrication
- Chemical industries
- Nuclear reactors

## Features

- Good resistance to crack and corrosion
- High efficiency
- Good arc stability and bead wetting

## Welding Position



1G 2F 3G 4G  
(PA) (PB) (PF-PG) (PE)

## Current

DC +

## Shielding Gas

Ar / Ar + O<sub>2</sub>

## Diameter / Packaging

Diameter	Spool			Pac		
	12.5kg (28lbs)	15kg (33 lbs)	20kg (44lbs)	150kg (330lbs)	200kg (440lbs)	250kg (551lbs)
mm (in)						
0.8 (0.033)	√					
0.9 (0.035)	√					
1.0 (0.040)	√	√				
1.2 (0.045)	√	√				
1.4 (0.052)						
1.6 (1/16)	√					

### Typical Chemical Composition of the Wire(%)

C	Si	Mn	Cr	Ni	Mo
0.02	0.39	1.69	19.5	12.8	2.5

### Typical Mechanical Properties of All-Weld Metal

TS MPa(lbs/in <sup>2</sup> )	EL (%)
570 (82,700)	39

### Typical Operating Procedures

Diameter, Polarity Shielding Gas	CTWD mm(in)	Wire Feed Speed m/min (in/min)	Voltage (volts)	Approx. Current (amps)	Melt-Off Rate kg/hr (lb/hr)
<b>1.0mm (0.040 in), DC +</b>					
100% Ar Gas	15~20 (0.59~0.78)	6.0 (236)	24	140	2.1 (4.6)
		7.1 (280)	24	160	2.5 (5.5)
		9.2 (362)	24	190	3.2 (7.1)
Mixed Gas (Ar + 2% O <sub>2</sub> )	15~20 (0.59~0.78)	5.2 (204)	26	160	1.8 (4.0)
		7.0 (276)	26	190	2.4 (5.3)
		8.3 (327)	26	220	2.9 (6.4)
<b>1.2mm (0.045 in), DC +</b>					
100% Ar Gas	15~20 (0.59~0.78)	9.2 (362)	27	190	4.6 (10.1)
		11.9 (469)	27	220	6.0 (13.2)
		15.5 (610)	27	260	7.8 (17.2)
Mixed Gas (Ar + 2% O <sub>2</sub> )	15~20 (0.59~0.78)	7.7 (303)	28	200	3.9 (8.6)
		8.6 (339)	28	230	4.3 (9.5)
		10.1 (398)	28	260	5.1 (11.2)

# SM-316LSi

Low carbon 18%Cr-12%Ni-2%Mo STS

## Conformances

AWS A5.9/ ASME SFA5.9 ER316LSi

JIS Z3321 YS316LSi

EN ISO 14343-A G 19 12 3L Si

## Applications

- Structural fabrication
- Chemical industries
- Nuclear reactors

## Features

- Good crack sensitivity
- High Si content
- Good arc stability and bead wetting

## Welding Position



1G 2F 3G 4G  
(PA) (PB) (PF-PG) (PE)

## Current

DC +

## Shielding Gas

Ar / Ar + O<sub>2</sub>

## Diameter / Packaging

Diameter mm (in)	Spool			Pac		
	5kg (11lbs)	12.5kg (28lbs)	15kg (33 lbs)	150kg (330lbs)	200kg (440lbs)	250kg (551lbs)
0.8 (0.033)		√	√			
0.9 (0.035)		√				
1.0 (0.040)	√	√	√			
1.2 (0.045)		√				
1.4 (0.052)						
1.6 (1/16)		√				
2.0 (0.079)		√				

**Typical Chemical Composition of the Wire(%)**

C	Si	Mn	Cr	Ni	Mo
0.030	0.65	2.36	19.76	11.62	2.50

**Typical Mechanical Properties of All-Weld Metal**

TS MPa(lbs/in <sup>2</sup> )	EL (%)
597 (86,600)	37

**Typical Operating Procedures**

Diameter, Polarity Shielding Gas	CTWD mm(in)	Wire Feed Speed m/min (in/min)	Voltage (volts)	Approx. Current (amps)	Melt-Off Rate kg/hr (lb/hr)
<b>1.0mm (0.040 in), DC +</b>					
100% Ar Gas	15~20 (0.59~0.78)	6.0 (236)	24	140	2.1 (4.6)
		7.1 (280)	24	160	2.5 (5.5)
		9.2 (362)	24	190	3.2 (7.1)
Mixed Gas (Ar + 2% O <sub>2</sub> )	15~20 (0.59~0.78)	5.2 (204)	26	160	1.8 (4.0)
		7.0 (276)	26	190	2.4 (5.3)
		8.3 (327)	26	220	2.9 (6.4)
<b>1.2mm (0.045 in), DC +</b>					
100% Ar Gas	15~20 (0.59~0.78)	9.2 (362)	27	190	4.6 (10.1)
		11.9 (469)	27	220	6.0 (13.2)
		15.5 (610)	27	260	7.8 (17.2)
Mixed Gas (Ar + 2% O <sub>2</sub> )	15~20 (0.59~0.78)	7.7 (303)	28	200	3.9 (8.6)
		8.6 (339)	28	230	4.3 (9.5)
		10.1 (398)	28	260	5.1 (11.2)

SM/AW

SAW

GM/AW

GT/AW

FC/AW

Non-FERROUS

APPENDIX

# SM-347

18%Cr-8%Ni-Nb(STS 347) & 18%Cr-8%Ni-Ti(STS 321)

## Conformances

AWS A5.9/ ASME SFA5.9 ER347

JIS Z3321 YS347

EN ISO 14343-A G 19 9 Nb

## Applications

- Boiler
- Gas turbine

## Features

- Good resistant to crack
- Good resistance corrosion and heat(Nb contents)

## Welding Position



1G 2F 3G 4G  
(PA) (PB) (PF-PG) (PE)

## Current

DC +

## Shielding Gas

Ar / Ar + O<sub>2</sub>

## Diameter / Packaging

Diameter	Spool			Pac		
	12.5kg (28lbs)	15kg (33 lbs)	20kg (44lbs)	150kg (330lbs)	200kg (440lbs)	250kg (551lbs)
mm (in)						
0.8 (0.033)	√					
0.9 (0.035)	√					
1.0 (0.040)	√					
1.2 (0.045)	√					
1.4 (0.052)						
1.6 (1/16)	√					

### Typical Chemical Composition of the Wire(%)

C	Si	Mn	Cr	Ni	Nb
0.05	0.43	1.66	20.0	9.6	0.7

### Typical Mechanical Properties of All-Weld Metal

TS MPa(lbs/in <sup>2</sup> )	EL (%)
680 (98,600)	30

### Typical Operating Procedures

Diameter, Polarity Shielding Gas	CTWD mm(in)	Wire Feed Speed m/min (in/min)	Voltage (volts)	Approx. Current (amps)	Melt-Off Rate kg/hr (lb/hr)
<b>1.0mm (0.040 in), DC +</b>					
100% Ar Gas	15~20 (0.59~0.78)	6.0 (236)	24	140	2.1 (4.6)
		7.1 (280)	24	160	2.5 (5.5)
		9.2 (362)	24	190	3.2 (7.1)
Mixed Gas (Ar + 2% O <sub>2</sub> )	15~20 (0.59~0.78)	5.2 (204)	26	160	1.8 (4.0)
		7.0 (276)	26	190	2.4 (5.3)
		8.3 (327)	26	220	2.9 (6.4)
<b>1.2mm (0.045 in), DC +</b>					
100% Ar Gas	15~20 (0.59~0.78)	9.2 (362)	27	190	4.6 (10.1)
		11.9 (469)	27	220	6.0 (13.2)
		15.5 (610)	27	260	7.8 (17.2)
Mixed Gas (Ar + 2% O <sub>2</sub> )	15~20 (0.59~0.78)	7.7 (303)	28	200	3.9 (8.6)
		8.6 (339)	28	230	4.3 (9.5)
		10.1 (398)	28	260	5.1 (11.2)

# SM-2209

22%Cr-5%Ni-2%Mo-0.15%N STS

## Conformances

AWS A5.9/ ASME SFA5.9 ER2209

JIS Z3321 YS2209

EN ISO 14343-A G 22 9 3N L

## Applications

- Offshore
- Petrochemical

## Features

- Good resistance to corrosion
- High resistance to chloride stress corrosion cracking(CSCC)

## Welding Position



1G 2F 3G 4G  
(PA) (PB) (PF-PG) (PE)

## Current

DC +

## Shielding Gas

Ar / Ar + O<sub>2</sub>

## Diameter / Packaging

Diameter	Spool			Pac		
	12.5kg (28lbs)	15kg (33 lbs)	20kg (44lbs)	150kg (330lbs)	200kg (440lbs)	250kg (551lbs)
mm (in)						
0.8 (0.033)	√					
0.9 (0.035)	√					
1.0 (0.040)	√					
1.2 (0.045)	√					
1.4 (0.052)						
1.6 (1/16)	√					



### Typical Chemical Composition of the Wire(%)

C	Si	Mn	Cr	Ni	Mo
0.01	0.41	1.70	23.4	8.9	3.2

### Typical Mechanical Properties of All-Weld Metal

TS MPa(lbs/in <sup>2</sup> )	EL (%)	Temp °C(°F)	CVN-Impact Value J (ft.-lbs)	PREN
784 (113,700)	30	-20 (-4)	83 (61)	35

### Typical Operating Procedures

Diameter, Polarity Shielding Gas	CTWD mm(in)	Wire Feed Speed m/min (in/min)	Voltage (volts)	Approx. Current (amps)	Melt-Off Rate kg/hr (lb/hr)
<b>1.0mm (0.040 in), DC +</b>					
100% Ar Gas	15~20 (0.59~0.78)	6.0 (236)	24	140	2.1 (4.6)
		7.1 (280)	24	160	2.5 (5.5)
		9.2 (362)	24	190	3.2 (7.1)
Mixed Gas (Ar + 2% O <sub>2</sub> )	15~20 (0.59~0.78)	5.2 (204)	26	160	1.8 (4.0)
		7.0 (276)	26	190	2.4 (5.3)
		8.3 (327)	26	220	2.9 (6.4)
<b>1.2mm (0.045 in), DC +</b>					
100% Ar Gas	15~20 (0.59~0.78)	9.2 (362)	27	190	4.6 (10.1)
		11.9 (469)	27	220	6.0 (13.2)
		15.5 (610)	27	260	7.8 (17.2)
Mixed Gas (Ar + 2% O <sub>2</sub> )	15~20 (0.59~0.78)	7.7 (303)	28	200	3.9 (8.6)
		8.6 (339)	28	230	4.3 (9.5)
		10.1 (398)	28	260	5.1 (11.2)

# SM-410

13%Cr STS(STS 403, STS 410)

## Conformances

AWS A5.9/ ASME SFA5.9 ER410

JIS Z3321 YS410

EN ISO 14343-A G 13

## Applications

- Hardfacing application

## Features

- Good resistance to corrosion and abrasion
- Good anti-abrasive property

## Welding Position



1G 2F 3G 4G  
(PA) (PB) (PF-PG) (PE)

## Current

DC +

## Shielding Gas

Ar / Ar + O<sub>2</sub>

## Diameter / Packaging

Diameter	Spool			Pac		
	5kg (11lbs)	12.5kg (28lbs)	15kg (33 lbs)	150kg (330lbs)	200kg (440lbs)	250kg (551lbs)
0.8 (0.033)		√				
0.9 (0.035)		√				
1.0 (0.040)		√				
1.2 (0.045)	√	√		√		
1.4 (0.052)						
1.6 (1/16)		√				

### Typical Chemical Composition of the Wire(%)

C	Si	Mn	Cr	Ni
0.10	0.38	0.34	12.0	0.17

### Typical Mechanical Properties of All-Weld Metal

TS MPa(lbs/in <sup>2</sup> )	EL (%)
540 (78,300)	35

### Typical Operating Procedures

Diameter, Polarity Shielding Gas	CTWD mm(in)	Wire Feed Speed m/min (in/min)	Voltage (volts)	Approx. Current (amps)	Melt-Off Rate kg/hr (lb/hr)
<b>1.0mm (0.040 in), DC +</b>					
100% Ar Gas	15~20 (0.59~0.78)	6.0 (236)	24	140	2.1 (4.6)
		7.1 (280)	24	160	2.5 (5.5)
		9.2 (362)	24	190	3.2 (7.1)
Mixed Gas (Ar + 2% O <sub>2</sub> )	15~20 (0.59~0.78)	5.2 (204)	26	160	1.8 (4.0)
		7.0 (276)	26	190	2.4 (5.3)
		8.3 (327)	26	220	2.9 (6.4)
<b>1.2mm (0.045 in), DC +</b>					
100% Ar Gas	15~20 (0.59~0.78)	9.2 (362)	27	190	4.6 (10.1)
		11.9 (469)	27	220	6.0 (13.2)
		15.5 (610)	27	260	7.8 (17.2)
Mixed Gas (Ar + 2% O <sub>2</sub> )	15~20 (0.59~0.78)	7.7 (303)	28	200	3.9 (8.6)
		8.6 (339)	28	230	4.3 (9.5)
		10.1 (398)	28	260	5.1 (11.2)

# SM-430LNb

13%Cr STS(STS 403, STS 410)

## Conformances

EN ISO 14343-A G 18LNb

JIS Z3321 YS430LNb

## Applications

- Automotive (Exhaust pipe)

## Features

- Good bead appearance
- Soft stable arc and low spatter

## Welding Position



1G 2F 3G 4G  
(PA) (PB) (PF-PG) (PE)

## Current

DC +

## Shielding Gas

Ar / Ar + O<sub>2</sub>

## Diameter / Packaging

Diameter	Spool			Pac			
	mm (in)	12.5kg (28lbs)	15kg (33 lbs)	20kg (44lbs)	150kg (330lbs)	200kg (440lbs)	250kg (551lbs)
0.8 (0.033)	✓						
0.9 (0.035)	✓						
1.0 (0.040)	✓						
1.2 (0.045)	✓						
1.4 (0.052)							✓
1.6 (1/16)	✓						

**Typical Chemical Composition of the Wire(%)**

C	Si	Mn	Cr	Ni	Nb
0.01	0.41	0.33	18.4	0.27	0.45

**Typical Mechanical Properties of All-Weld Metal**

Dia (mm)	Amp (A)	Vol (V)	Cpm (cm/min)	Gas Flow (/min)	Shielding Gas
1.2	250	26	30	25	100% Ar or Ar + 2% O <sub>2</sub>
1.6	300	29	35		

**Typical Operating Procedures**

Diameter, Polarity Shielding Gas	CTWD mm(in)	Wire Feed Speed m/min (in/min)	Voltage (volts)	Approx. Current (amps)	Melt-Off Rate kg/hr (lb/hr)
<b>1.0mm (0.040 in), DC +</b>					
100% Ar Gas	15~20 (0.59~0.78)	6.0 (236)	24	140	2.1 (4.6)
		7.1 (280)	24	160	2.5 (5.5)
		9.2 (362)	24	190	3.2 (7.1)
Mixed Gas (Ar + 2% O <sub>2</sub> )	15~20 (0.59~0.78)	5.2 (204)	26	160	1.8 (4.0)
		7.0 (276)	26	190	2.4 (5.3)
		8.3 (327)	26	220	2.9 (6.4)
<b>1.2mm (0.045 in), DC +</b>					
100% Ar Gas	15~20 (0.59~0.78)	9.2 (362)	27	190	4.6 (10.1)
		11.9 (469)	27	220	6.0 (13.2)
		15.5 (610)	27	260	7.8 (17.2)
Mixed Gas (Ar + 2% O <sub>2</sub> )	15~20 (0.59~0.78)	7.7 (303)	28	200	3.9 (8.6)
		8.6 (339)	28	230	4.3 (9.5)
		10.1 (398)	28	260	5.1 (11.2)

SMW

SAW

GMW

GTAW

FCAW

Non-FERROUS

APPENDIX

# Note

---

# GTAW

## TIG Rod



# ST-50G

Mild Steel & 490 MPa high tensile steels

## Conformances

AWS	A5.18/ ASME SFA5.18 ER70S-G
JIS	Z3316 YGT50
EN	ISO 636-A-W3Si1
KR	3YSG
ABS	AWS A5.18 ER70S-G
LR	3, 3YH15
BV	UP(-20°C)
NK	IIIYM
DNV	3Y
GL	KSW53G
CCS	3YS

## Applications

- Pressure vessels
- Nuclear reactors
- Rail road car
- Shipbuilding
- Pipeline

## Features

- Good impact value at low temperature
- Good bead appearance
- Good performance

## Welding Position



1G 2F 3G 4G  
(PA) (PB) (PF-PG) (PE)

## Current

DC -

## Shielding Gas

Ar

## Diameter / Packaging

Diameter	PVC TUVE
mm (in)	5kg (11lbs)
1.2 (0.045)	✓
1.6 (1/16)	✓
2.0 (5/64)	✓
2.4 (3/32)	✓
3.2 (1/8)	✓

## Typical Chemical Composition of the Wire(%)

C	Si	Mn		
0.07	0.83	1.43		

## Typical Mechanical Properties of All-Weld Metal

	YS MPa(lbs/in <sup>2</sup> )	TS MPa(lbs/in <sup>2</sup> )	EL (%)	Temp °C(°F)	CVN-Impact Value J (ft-lbs)
As welded with 100% Ar	460 (66,700)	530 (76,900)	27	-20 (-4)	170 (125)



# ST-50.6

Mild Steel & 490 MPa high tensile steels



## Conformances

AWS A5.18/ ASME SFA5.18 ER70S-6  
 JIS Z3316 YGT50  
 EN ISO 636-A-W3Si1  
 TÜV ISO 636-A-W42 5 W3Si1  
 ABS AWS A5.18 ER70S-6(-30)  
 CWB CSA W48 B-G 49A 3 C G6  
 CE

## Applications

- Pressure vessels
- Nuclear reactors
- Rail road car
- Shipbuilding
- Pipeline

## Features

- Good impact value at low temperature
- Good bead appearance
- Good performance

## Welding Position



1G 2F 3G 4G  
 (PA) (PB) (PF-PG) (PE)

## Current

DC -

## Shielding Gas

Ar

## Diameter / Packaging

Diameter	PVC TUVE
mm (in)	5kg (11lbs)
1.2 (0.045)	✓
1.6 (1/16)	✓
2.0 (5/64)	✓
2.4 (3/32)	✓
3.2 (1/8)	✓

## Typical Chemical Composition of the Wire(%)

C	Si	Mn		
0.07	0.85	1.5		

## Typical Mechanical Properties of All-Weld Metal

	YS MPa(lbs/in <sup>2</sup> )	TS MPa(lbs/in <sup>2</sup> )	EL (%)	Temp °C(°F)	CVN-Impact Value J (ft-lbs)
As welded with 100% Ar	450 (65,300)	520 (75,500)	28	-20 (-4)	180 (132)

SWAW

SAW

GMAW

GTAW

FCAW

Non-FERROUS

APPENDIX

# ST-50.3

Mild Steel & 490 MPa high tensile steels

## Conformances

AWS A5.18/ ASME SFA5.18 ER70S-3

EN ISO 636-A-W2Si

ABS AWS A5.18 ER70S-3(-50)

## Welding Position



1G 2F 3G 4G  
(PA) (PB) (PF-PG) (PE)

## Current

DC -

## Shielding Gas

Ar

## Diameter / Packaging

Diameter	PVC TUVE
mm (in)	5kg (11lbs)
1.2 (0.045)	✓
1.6 (1/16)	✓
2.0 (5/64)	✓
2.4 (3/32)	✓
3.2 (1/8)	✓

## Applications

- Pressure vessels
- Nuclear reactors
- Rail road car
- Shipbuilding
- Pipeline

## Features

- Good impact value at low temperature
- Good bead appearance
- Good performance

## Typical Chemical Composition of the Wire(%)

C	Si	Mn		
0.07	0.65	1.15		

## Typical Mechanical Properties of All-Weld Metal

	YS MPa(lbs/in <sup>2</sup> )	TS MPa(lbs/in <sup>2</sup> )	EL (%)	Temp °C(°F)	CVN-Impact Value J (ft-lbs)
As welded with 100% Ar	495 (71,800)	565 (81,950)	26	-20 (-4)	170 (125)

# ST-72

Mild Steel & 490 MPa high tensile steels

## Conformances

AWS A5.18/ ASME SFA5.18 ER70S-2

JIS Z3316 YGT50

## Applications

- Pressure vessels
- Shipbuilding

## Features

- Good performance in all position
- One-side welding (tube)
- Ar 100% gas

## Welding Position



1G 2F 3G 4G  
(PA) (PB) (PF-PG) (PE)

## Current

DC -

## Shielding Gas

Ar

## Diameter / Packaging

Diameter	PVC TUVE
mm (in)	5kg (11lbs)
1.2 (0.045)	✓
1.6 (1/16)	✓
2.0 (5/64)	✓
2.4 (3/32)	✓
3.2 (1/8)	✓

## Typical Chemical Composition of the Wire(%)

C	Si	Mn	Ti	Zr	Al
0.05	0.52	1.15	0.07	0.05	0.06

## Typical Mechanical Properties of All-Weld Metal

	YS MPa(lbs/in <sup>2</sup> )	TS MPa(lbs/in <sup>2</sup> )	EL (%)	Temp °C(°F)	CVN-Impact Value J (ft-lbs)
As welded with 100% Ar	500 (72,500)	580 (84,200)	29	-30 (-22)	180 (132)

SMW

SAW

GMAW

GTAW

FCAW

Non-FERROUS

APPENDIX

# ST-1N

Mild Steel & 490 MPa high tensile steels

## Conformances

AWS A5.28/ ASME SFA5.28 ER80S-Ni1  
 ABS AWS A5.28 ER80S-Ni1(-50)  
 CWB AWS A5.28 ER80S-Ni1(-50 Degree)

## Applications

- Offshore
- Power plant
- Petrochemical
- Chemical industry

## Features

- Good impact value at low temperature (1% Ni)
- Back bead pipe applicable
- Good performance
- Meets NACE Standard

## Welding Position

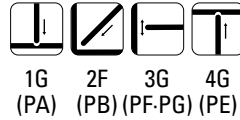

## Current

DC -

## Shielding Gas

Ar

## Diameter / Packaging

Diameter	PVC TUVE
mm (in)	5kg (11lbs)
1.2 (0.045)	✓
1.6 (1/16)	✓
2.0 (5/64)	✓
2.4 (3/32)	✓
3.2 (1/8)	✓

## Typical Chemical Composition of the Wire(%)

C	Si	Mn	P	S	Ni	Cu
0.088	0.62	1.15	0.011	0.010	0.93	0.08

## Typical Mechanical Properties of All-Weld Metal

	YS MPa(lbs/in <sup>2</sup> )	TS MPa(lbs/in <sup>2</sup> )	EL (%)	Temp °C(°F)	CVN-Impact Value J (ft.lbs)
As welded with 100% Ar	594 (86,000)	671 (97,300)	32.3	-45 (-49)	59 (43)
PWHT	568 (82,400)	645 (93,500)	34.0	-45 (-49)	108 (79)

# ST-80CM

Heat resistance – low alloy steel

## Conformances

AWS A5.28/ ASME SFA5.28 ER80S-G  
 JIS Z3317 YG1CM-A / JIS Z3316 YGT1CM  
 EN ISO 14341-B S2M3

## Applications

- Pressure vessels
- Offshore
- Machinery
- Chemical industry

## Features

- MIG welding for boiler steam pipe of steam power generation and 1.0~1.25%Cr-0.5%Mo heat resisting steel using for refining oil & chemical industrial machine tool.
- Excellent TS and impact value in a high temperature after heat treatment.

## Welding Position



1G 2F  
(PA) (PB)

## Current

DC +

## Shielding Gas

100% Ar  
 Ar + 2% O<sub>2</sub>

## Diameter / Packaging

Diameter	Spool			Pac		
	5kg (11lbs)	15kg (33lbs)	20kg (44lbs)	250kg (551lbs)	300kg (661lbs)	350kg (771lbs)
0.8 (0.033)	✓	✓	✓	✓	✓	✓
0.9 (0.035)	✓	✓	✓	✓	✓	✓
1.0 (0.040)	✓	✓	✓	✓	✓	✓
1.2 (0.045)	✓	✓	✓	✓	✓	✓
1.4 (0.052)	✓	✓	✓	✓	✓	✓
1.6 (1/16)	✓	✓	✓	✓	✓	✓

SMW

SAW

GMW

GTAW

FCW

Non-FERROUS

APPENDIX

**Typical Chemical Composition of the Wire(%)**

C	Si	Mn	Cr	Mo
0.09	0.67	1.02	1.19	0.45

**Typical Mechanical Properties of All-Weld Metal**

	YS MPa(lbs/in <sup>2</sup> )	EL (%)	Temp °C(°F)	CVN-Impact Value J (ft.lbs)	PWHT
As welded with 100% Ar	630 (91,500)	28	0 (32) -20 (-4)	290 (215) 280 (207)	690°C * 1Hr

**Typical Operating Procedures**

Diameter, Polarity Shielding Gas	CTWD mm(in)	Wire Feed Speed m/min (in/min)	Voltage (volts)	Approx. Current (amps)	Melt-Off Rate kg/hr (lb/hr)
<b>0.9mm (0.035in), DC +</b>					
100% CO <sub>2</sub> Gas	12 (1/2)	2.5 (100)	18	80	0.7 (1.6)
		3.8 (150)	19	120	1.1 (2.4)
		6.4 (250)	21	175	1.8 (4.0)
Mixed Gas (Ar+CO <sub>2</sub> )	19 (3/4)	8.9 (350)	23	195	2.7 (6.0)
		12.7 (500)	29	230	3.6 (8.0)
		15.2 (600)	30	275	4.4 (9.6)
<b>1.0mm (0.040in), DC +</b>					
100% CO <sub>2</sub> Gas	12 (1/2)	2.5 (100)	18	80	0.7 (1.6)
		3.8 (150)	19	120	1.1 (2.4)
		6.4 (250)	21	175	1.8 (4.0)
Mixed Gas (Ar+CO <sub>2</sub> )	19 (3/4)	8.9 (350)	23	195	2.7 (6.0)
		12.7 (500)	29	230	3.6 (8.0)
		15.2 (600)	30	275	4.4 (9.6)
<b>1.2mm (0.045in), DC +</b>					
100% CO <sub>2</sub> Gas	12 (1/2)	2.5 (100)	18	80	0.7 (1.6)
		3.8 (150)	19	120	1.1 (2.4)
		6.4 (250)	21	175	1.8 (4.0)
Mixed Gas (Ar+CO <sub>2</sub> )	19 (3/4)	8.9 (350)	23	195	2.7 (6.0)
		12.7 (500)	29	230	3.6 (8.0)
		15.2 (600)	30	275	4.4 (9.6)

# ST-308

Stainless steel

## Conformances

AWS A5.9/ ASME SFA5.9 ER308  
JIS Z3321 YS308  
EN ISO 14343-A W 19 9  
KR RY308G  
ABS AWS A5.9 ER308  
DNV 308

## Applications

- Structural fabrication
- Petrochemical
- Oil and textile industries
- Nuclear reactor

## Features

- Good resistance to crack and corrosion
- High efficiency

## Current

DC -

## Shielding Gas

Ar

## Diameter / Packaging

Diameter	
mm (in)	5kg*1000
1.0 (0.039)	
1.2 (0.045)	✓
1.6 (1/16)	✓
2.0 (5/64)	✓
2.4 (3/32)	✓
2.6 (0.10)	✓
3.2 (1/8)	✓

## Typical Chemical Composition of the Wire(%)

C	Si	Mn	Cr	Ni
0.05	0.38	1.75	19.8	10.1

## Typical Mechanical Properties of All-Weld Metal

TS MPa(lbs/in <sup>2</sup> )	EL (%)	Temp °C(°F)	CVN-Impact Value J (ft.-lbs)
610 (88,500)	40	0 (32)	130 (95)

SMW

SAW

GMW

GTAW

FCW

Non-FERROUS

APPENDIX

# ST-308L

Low carbon 18%Cr-8%Ni steel

## Conformances

AWS	A5.9/ ASME SFA5.9 ER308L
JIS	Z3321 YS308L
EN	ISO 14343-A W 19 9L
KR	RY308L (-196°C ≥29 J)
ABS	AWS A5.9 ER308L
LR	304L (-196°C)
BV	UP (KV -196°C)
DNV	308L (-196°C)
NK	KY308L
CCS	304L

## Applications

- Structural fabrication
- Petrochemical
- Oil and textile industries
- Nuclear reactor

## Features

- Good resistance to crack and corrosion
- High efficiency

## Current

DC -

## Shielding Gas

Ar

## Diameter / Packaging

Diameter	
mm (in)	5kg*1000
1.0 (0.039)	✓
1.2 (0.045)	✓
1.6 (1/16)	✓
2.0 (5/64)	✓
2.4 (3/32)	✓
2.6 (0.10)	✓
3.2 (1/8)	✓

## Typical Chemical Composition of the Wire(%)

C	Si	Mn	Cr	Ni
0.02	0.36	1.70	20.0	10.3

## Typical Mechanical Properties of All-Weld Metal

TS MPa(lbs/in <sup>2</sup> )	EL (%)	Temp °C(°F)	CVN-Impact Value J (ft-lbs)
600 (87,000)	41	0 (32)	110 (81)



# ST-309

22%Cr-12%Ni steel, 18%Cr-8%Ni clad steel, STS-CrMo, STS-Carbon steel

## Conformances

AWS A5.9/ ASME SFA5.9 ER309  
 JIS Z3321 YS309  
 EN ISO 14343-A W 23 12  
 ABS AWS A5.9 ER309

## Applications

- Structural fabrication
- Petrochemical
- Oil and textile industries
- Nuclear reactor

## Features

- Good resistance to crack and heat
- High efficiency

## Current

DC -

## Shielding Gas

Ar

## Diameter / Packaging

Diameter	
mm (in)	5kg*1000
1.0 (0.039)	
1.2 (0.045)	
1.6 (1/16)	✓
2.0 (5/64)	✓
2.4 (3/32)	✓
2.6 (0.10)	✓
3.2 (1/8)	✓

## Typical Chemical Composition of the Wire(%)

C	Si	Mn	Cr	Ni
0.07	0.38	1.88	24.4	12.8

## Typical Mechanical Properties of All-Weld Metal

TS MPa(lbs/in <sup>2</sup> )	EL (%)	Temp °C(°F)	CVN-Impact Value J (ft-lbs)
620 (90,000)	38	0 (32)	130 (96)

SMW

SAW

GMW

GTAW

FCW

Non-FERROUS

APPENDIX

# ST-309L

22%Cr-12%Ni steel, 18%Cr-8%Ni clad steel, STS-CrMo, STS-Carbon steel

## Conformances

AWS A5.9/ ASME SFA5.9 ER309L  
JIS Z3321 YS309L  
EN ISO 14343-A W 23 12L  
ABS AWS A5.9 ER309L  
LR SS/CMn  
BV 309L  
DNV 309L  
NK KY309L  
CCS 309L

## Applications

- Structural fabrication
- Petrochemical
- Oil and textile industries
- Nuclear reactor

## Features

- Good resistance to crack and heat
- High efficiency

## Current

DC -

## Shielding Gas

Ar

## Diameter / Packaging

Diameter	
mm (in)	5kg*1000
1.0 (0.039)	
1.2 (0.045)	✓
1.6 (1/16)	✓
2.0 (5/64)	✓
2.4 (3/32)	✓
2.6 (0.10)	✓
3.2 (1/8)	✓

## Typical Chemical Composition of the Wire(%)

C	Si	Mn	Cr	Ni
0.03	0.40	1.74	24.2	12.6

## Typical Mechanical Properties of All-Weld Metal

TS MPa(lbs/in <sup>2</sup> )	EL (%)	Temp °C(°F)	CVN-Impact Value J (ft-lbs)
600 (87,000)	38	0 (32)	150 (110)

# ST-309MoL

Dissimilar metals such as stainless steels and carbon steels

## Conformances

AWS A5.9/ ASME SFA5.9 ER309LMo

JIS Z3321 YS309LMo

EN ISO 14343-A W 23 12 2L

## Applications

- STS clad steel (316, 316L)

## Features

- Good resistance to corrosion and heat
- Good arc stability and bead wetting

## Current

DC -

## Shielding Gas

Ar

## Diameter / Packaging

Diameter	
mm (in)	5kg*1000
1.0 (0.039)	
1.2 (0.045)	
1.6 (1/16)	✓
2.0 (5/64)	✓
2.4 (3/32)	✓
2.6 (0.10)	✓
3.2 (1/8)	✓

## Typical Chemical Composition of the Wire(%)

C	Si	Mn	Cr	Ni	Mo
0.02	0.35	1.8	23.2	13.7	2.5

## Typical Mechanical Properties of All-Weld Metal

TS MPa(lbs/in <sup>2</sup> )	EL (%)
650 (94,200)	32

SMW

SAW

GMAW

GTAW

FCAW

Non-FERROUS

APPENDIX

# ST-310

25%Cr-20%Ni STS

## Conformances

AWS A5.9/ ASME SFA5.9 ER310

JIS Z3321 YS310

EN ISO 14343-A W 25 20

## Applications

- STS clad steel

## Features

- Good resistance to corrosion and heat
- Good arc stability and bead wetting

## Current

DC -

## Shielding Gas

Ar

## Diameter / Packaging

Diameter	
mm (in)	5kg*1000
1.0 (0.039)	
1.2 (0.045)	
1.6 (1/16)	✓
2.0 (5/64)	✓
2.4 (3/32)	✓
2.6 (0.10)	✓
3.2 (1/8)	✓

## Typical Chemical Composition of the Wire(%)

C	Si	Mn	Cr	Ni
0.09	0.35	1.90	26.8	20.9

## Typical Mechanical Properties of All-Weld Metal

TS MPa(lbs/in <sup>2</sup> )	EL (%)	Temp °C(°F)	CVN-Impact Value J (ft-lbs)
610 (88,500)	41	0 (32)	110 (81)

# ST-312

29%Cr-9%Ni STS, joining of dissimilar-metal

## Conformances

AWS A5.9/ ASME SFA5.9 ER312

JIS Z3321 YS312

EN ISO 14343-A W 29 9

## Applications

- Welding of dissimilar-metal STS to ferritic steel or special steel

## Features

- Good resistance to crack and corrosion
- High efficiency
- Good arc stability and bead wetting

## Current

DC -

## Shielding Gas

Ar

## Diameter / Packaging

Diameter	
mm (in)	5kg*1000
1.0 (0.039)	
1.2 (0.045)	
1.6 (1/16)	✓
2.0 (5/64)	✓
2.4 (3/32)	✓
2.6 (0.10)	✓
3.2 (1/8)	✓

## Typical Chemical Composition of the Wire(%)

C	Si	Mn	Cr	Ni
0.10	0.38	1.68	30.0	8.8

## Typical Mechanical Properties of All-Weld Metal

TS MPa(lbs/in <sup>2</sup> )	EL (%)
770 (111,600)	27

SMW

SAW

GMW

GTAW

FCW

Non-FERROUS

APPENDIX

# ST-316

18%Cr-12%Ni-2%Mo STS

## Conformances

AWS A5.9/ ASME SFA5.9 ER316  
JIS Z3321 YS316  
EN ISO 14343-A W 19 12 3  
ABS AWS A5.9 ER316

## Applications

- Structural fabrication
- Chemical industries
- Nuclear reactors

## Features

- Good resistance to crack and corrosion
- High efficiency
- Good arc stability and bead wetting

## Current

DC -

## Shielding Gas

Ar

## Diameter / Packaging

Diameter	
mm (in)	5kg*1000
1.0 (0.039)	
1.2 (0.045)	
1.6 (1/16)	✓
2.0 (5/64)	✓
2.4 (3/32)	✓
2.6 (0.10)	✓
3.2 (1/8)	✓

## Typical Chemical Composition of the Wire(%)

C	Si	Mn	Cr	Ni	Mo
0.05	0.41	1.82	18.9	12.5	2.5

## Typical Mechanical Properties of All-Weld Metal

TS MPa(lbs/in <sup>2</sup> )	EL (%)	Temp °C(°F)	CVN-Impact Value J (ft-lbs)
590 (85,600)	41	0 (32)	130 (95)

# ST-316L

Low carbon 18%Cr-12%Ni-2%Mo STS

## Conformances

AWS	A5.9/ ASME SFA5.9 ER316L
JIS	Z3321 YS316L
EN	ISO 14343-A W 19 12 3L
KR	RY316L (-196°C ≥29 J)
ABS	AWS A5.9 ER316L
LR	316L (-196°C)
BV	316L (KV -196°C)
DNV	316L (-196°C)
GL	4435
NK	KY316L
CCS	316L
CWB	AWS A5.9 ER316L

## Applications

- Structural fabrication
- Chemical industries
- Nuclear reactors

## Features

- Good resistance to crack and corrosion
- High efficiency
- Good arc stability and bead wetting

## Current

DC -

## Shielding Gas

Ar

## Diameter / Packaging

Diameter	
mm (in)	5kg*1000
1.0 (0.039)	✓
1.2 (0.045)	✓
1.6 (1/16)	✓
2.0 (5/64)	✓
2.4 (3/32)	✓
2.6 (0.10)	✓
3.2 (1/8)	✓

## Typical Chemical Composition of the Wire(%)

C	Si	Mn	Cr	Ni	Mo
0.02	0.38	1.85	18.8	12.4	2.5

## Typical Mechanical Properties of All-Weld Metal

TS MPa(lbs/in <sup>2</sup> )	EL (%)	Temp °C(°F)	CVN-Impact Value J (ft-lbs)
570 (82,700)	44	0 (32)	140 (103)

SMW

SAW

GMW

GTAW

FCW

Non-FERROUS

APPENDIX

# ST-347

18%Cr-8%Ni-Nb(STS 347) & 18%Cr-8%Ni-Ti(STS 321)

## Conformances

AWS A5.9/ ASME SFA5.9 ER347

JIS Z3321 YS347

EN ISO 14343-A W 199 Nb

## Applications

- Boiler
- Gas turbine

## Features

- Good resistance to crack
- Good resistance corrosion and heat(Nb contents)

## Current

DC -

## Shielding Gas

Ar

## Diameter / Packaging

Diameter	
mm (in)	5kg*1000
1.0 (0.039)	
1.2 (0.045)	
1.6 (1/16)	✓
2.0 (5/64)	✓
2.4 (3/32)	✓
2.6 (0.10)	✓
3.2 (1/8)	✓

## Typical Chemical Composition of the Wire(%)

C	Si	Mn	Cr	Ni	Nb
0.05	0.43	1.66	20.0	9.6	0.7

## Typical Mechanical Properties of All-Weld Metal

TS	EL
MPa(lbs/in <sup>2</sup> )	(%)
680 (98,600)	32



# SMT-2594

25%Cr-7%Ni-4.5%Mo-0.25%N Super Duplex STS

## Conformances

AWS A5.9/ ASME SFA5.9 ER2594

EN ISO 14343-A G 25 9 4 NL

ABS AWS A5.9 ER2594

## Applications

- Offshore & FPSO
- Chemical industries
- Petrochemical

## Features

- Good resistance to corrosion
- Superior pitting resistance

## Welding Position



1G 2F 3G 4G  
(PA) (PB) (PF-PG) (PE)

## Current

GMAW: DC + / GTAW: DC -

## Shielding Gas

Ar / Ar+ O<sub>2</sub>

## Diameter / Packaging

Diameter	Spool			Pac		
	12.5kg (28lbs)	15kg (33 lbs)	20kg (44lbs)	150kg (330lbs)	200kg (440lbs)	250kg (551lbs)
0.8 (0.033)	✓					
0.9 (0.035)	✓					
1.0 (0.040)	✓					
1.2 (0.045)	✓					
1.4 (0.052)						
1.6 (1/16)	✓					

Diameter	5kg*1000						
	1.0 (0.039)	1.2 (0.045)	1.6 (1/16)	2.0 (5/64)	2.4 (3/32)	2.6 (0.10)	3.2 (1/8)
mm (in)			✓	✓	✓	✓	✓

SMW

SAW

GMAW

GTAW

FCAW

Non-FERROUS

APPENDIX

### Typical Chemical Composition of the Wire(%)

C	Si	Mn	P	S	Cr	Ni	Mo	Cu	N
0.011	0.41	0.53	0.019	0.001	25.27	9.13	3.86	0.21	0.257

### Typical Mechanical Properties of All-Weld Metal

TS MPa(lbs/in <sup>2</sup> )	EL (%)	Temp °C(°F)	CVN-Impact Value J (ft.-lbs)	PREN
890 (129,000)	28.6	-50 (-58)	195 (144)	40

### Typical Operating Procedures

Diameter, Polarity Shielding Gas	CTWD mm(in)	Wire Feed Speed m/min (in/min)	Voltage (volts)	Approx. Current (amps)	Melt-Off Rate kg/hr (lb/hr)
<b>1.0mm (0.040 in), DC +</b>					
100% Ar Gas	15~20 (0.59~0.78)	6.0 (236)	24	140	2.1 (4.6)
		7.1 (280)	24	160	2.5 (5.5)
		9.2 (362)	24	190	3.2 (7.1)
Mixed Gas (Ar + 2% O <sub>2</sub> )	15~20 (0.59~0.78)	5.2 (204)	26	160	1.8 (4.0)
		7.0 (276)	26	190	2.4 (5.3)
		8.3 (327)	26	220	2.9 (6.4)
<b>1.2mm (0.045 in), DC +</b>					
100% Ar Gas	15~20 (0.59~0.78)	9.2 (362)	27	190	4.6 (10.1)
		11.9 (469)	27	220	6.0 (13.2)
		15.5 (610)	27	260	7.8 (17.2)
Mixed Gas (Ar + 2% O <sub>2</sub> )	15~20 (0.59~0.78)	7.7 (303)	28	200	3.9 (8.6)
		8.6 (339)	28	230	4.3 (9.5)
		10.1 (398)	28	260	5.1 (11.2)

# ST-2209

22%Cr-5%Ni-2%Mo-0.15%N STS

## Conformances

AWS A5.9/ ASME SFA5.9 ER2209  
JIS Z3321 YS2209  
EN ISO 14343-A W 22 9 3N L  
ABS AWS A5.9 ER2209(-50)  
LR S31803m  
DNV Duplex Stainless Steel

## Applications

- Offshore
- Petrochemical

## Features

- Good resistance to corrosion
- High resistance to chloride stress corrosion cracking(CSCC)

## Current

DC -

## Shielding Gas

Ar

## Diameter / Packaging

Diameter	
mm (in)	5kg*1000
1.0 (0.039)	
1.2 (0.045)	
1.6 (1/16)	✓
2.0 (5/64)	✓
2.4 (3/32)	✓
2.6 (0.10)	✓
3.2 (1/8)	✓

## Typical Chemical Composition of the Wire(%)

C	Si	Mn	Cr	Ni	Mo
0.01	0.41	1.70	23.4	8.9	3.2

## Typical Mechanical Properties of All-Weld Metal

TS MPa(lbs/in <sup>2</sup> )	EL (%)	Temp °C(°F)	CVN-Impact Value J (ft-lbs)	PREN
810 (116,700)	27	-20 (-4)	195 (144)	35

SMW

SAW

GMW

GTAW

FCW

Non-FERROUS

APPENDIX

# SMT-904L

20%Cr-25%Ni-4.5%Mo-1.5%Cu STS

## Conformances

AWS A5.9/ ASME SFA5.9 ER385

JIS Z3321 YS385

EN ISO 14343-A G(W) 20 25 5 Cu L

## Applications

- Offshore & FPSO
- Chemical industries
- Petrochemical

## Features

- Good resistance to corrosion
- Preferably keep heat input below 1.5KJ/mm

## Welding Position



1G 2F 3G 4G  
(PA) (PB) (PF-PG) (PE)

## Current

GMAW: DC + / GTAW: DC -

## Shielding Gas

Ar / Ar+ O<sub>2</sub>

## Diameter / Packaging

Diameter mm (in)	Spool			Pac		
	12.5kg (28lbs)	15kg (33 lbs)	20kg (44lbs)	150kg (330lbs)	200kg (440lbs)	250kg (551lbs)
0.8 (0.033)	✓					
0.9 (0.035)	✓					
1.0 (0.040)	✓					
1.2 (0.045)	✓					
1.4 (0.052)						
1.6 (1/16)	✓					

Diameter mm (in)	5kg*1000						
	1.0 (0.039)	1.2 (0.045)	1.6 (1/16)	2.0 (5/64)	2.4 (3/32)	2.6 (0.10)	3.2 (1/8)
			✓	✓	✓	✓	✓

### Typical Chemical Composition of the Wire(%)

C	Si	Mn	P	S	Cr	Ni	Mo	Cu
0.013	0.31	1.89	0.013	0.001	20.52	24.96	4.32	1.42

### Typical Mechanical Properties of All-Weld Metal

YS MPa(lbs/in <sup>2</sup> )	TS MPa(lbs/in <sup>2</sup> )	EL (%)	Temp °C(°F)	CVN-Impact Value J (ft-lbs)
490 (71,000)	650 (94,300)	35.0	20 (68)	110 (81)
			-196 (-321)	70 (52)

### Typical Operating Procedures

Diameter, Polarity Shielding Gas	CTWD mm(in)	Wire Feed Speed m/min (in/min)	Voltage (volts)	Approx. Current (amps)	Melt-Off Rate kg/hr (lb/hr)
<b>1.0mm (0.040 in), DC +</b>					
100% Ar Gas	15~20 (0.59~0.78)	6.0 (236)	24	140	2.1 (4.6)
		7.1 (280)	24	160	2.5 (5.5)
		9.2 (362)	24	190	3.2 (7.1)
Mixed Gas (Ar + 2% O <sub>2</sub> )	15~20 (0.59~0.78)	5.2 (204)	26	160	1.8 (4.0)
		7.0 (276)	26	190	2.4 (5.3)
		8.3 (327)	26	220	2.9 (6.4)
<b>1.2mm (0.045 in), DC +</b>					
100% Ar Gas	15~20 (0.59~0.78)	9.2 (362)	27	190	4.6 (10.1)
		11.9 (469)	27	220	6.0 (13.2)
		15.5 (610)	27	260	7.8 (17.2)
Mixed Gas (Ar + 2% O <sub>2</sub> )	15~20 (0.59~0.78)	7.7 (303)	28	200	3.9 (8.6)
		8.6 (339)	28	230	4.3 (9.5)
		10.1 (398)	28	260	5.1 (11.2)

# ST-410

13%Cr STS(STS 403, STS 410)

## Conformances

AWS A5.9/ ASME SFA5.9 ER410

JIS Z3321 YS410

EN ISO 14343-A W 13

## Applications

- Hardfacing application

## Features

- Good resistance to corrosion and abrasion
- Good anti-abrasive property

## Current

DC -

## Shielding Gas

Ar

## Diameter / Packaging

Diameter	
mm (in)	5kg*1000
1.0 (0.039)	
1.2 (0.045)	
1.6 (1/16)	✓
2.0 (5/64)	✓
2.4 (3/32)	✓
2.6 (0.10)	✓
3.2 (1/8)	✓

## Typical Chemical Composition of the Wire(%)

C	Si	Mn	Cr	Ni
0.10	0.38	0.34	12.0	0.17

## Typical Mechanical Properties of All-Weld Metal

TS MPa(lbs/in <sup>2</sup> )	EL (%)	Temp °C(°F)	CVN-Impact Value J (ft-lbs)
530 (76,800)	37	0 (32)	-

# SM-90B3 / ST-90B3

2.25%Cr- 1%Mo steels, Joining carbon steel and Cr-Mo alloys

## Conformances

AWS A5.28/ ASME SFA5.28 ER90S-B3

## Applications

- High pressure pipe
- Pressure vessels

## Features

- Careful control of preheat, interpass temperatures postweld heat treatment is essential to prevent cracking

## Welding Position



1G 2F 3G 4G  
(PA) (PB) (PF-PG) (PE)

## Current

GMAW: DC + / GTAW: DC -

## Shielding Gas

Ar

## Diameter / Packaging

Diameter mm (in)	Spool			Pac		
	10kg (22lbs)	15kg (33 lbs)	20kg (44lbs)	30kg (66lbs)	150kg (330lbs)	200kg (440lbs)
0.8 (0.033)						
0.9 (0.035)						
1.0 (0.040)						
1.2 (0.045)		✓	✓			
1.4 (0.052)						
1.6 (1/16)						

Diameter	5kg*1000						
mm (in)	1.0 (0.039)	1.2 (0.045)	1.6 (1/16)	2.0 (5/64)	2.4 (3/32)	2.6 (0.10)	3.2 (1/8)
				✓	✓		✓

## Typical Chemical Composition of the Wire(%)

C	Si	Mn	Cr	Ni	Mo	Cu	Shielding Gas
0.118	0.48	0.54	2.48	0.15	0.98	0.32	Ar

## Typical Mechanical Properties of All-Weld Metal

	YS MPa(lbs/in <sup>2</sup> )	TS MPa(lbs/in <sup>2</sup> )	EL (%)
As welded with 100% Ar	590 (85,600)	759 (109,518)	24

SMW

SAW

GMAW

GTAW

FCAW

Non-FERROUS

APPENDIX

# ST-91B9

A213 T91(Seamless tube), A335 P91(Seamless pipe), A387 Gr91(Plate), A182/A336 F91(forging), A234 WP91

## Conformances

AWS A5.28/ ASME SFA5.28 ER90S-B9

EN ISO 21952-A W CrMo91

## Applications

- Headers
- Steam piping and turbine casings

## Features

- Good resistance to creep at high temperature
- Tempered martensite structure with alloy carbides in the PWHT

## Current

GTAW: DC -

## Shielding Gas

Ar

## Diameter / Packaging

Diameter	
mm (in)	5kg*1000
1.0 (0.039)	
1.2 (0.045)	
1.6 (1/16)	
2.0 (5/64)	
2.4 (3/32)	√
2.6 (0.10)	
3.2 (1/8)	

## Typical Chemical Composition of the Wire(%)

C	Si	Mn	Cr	Ni	Mo	Shielding Gas
0.10	0.30	0.47	8.91	0.67	0.96	Ar

## Typical Mechanical Properties of All-Weld Metal

	YS MPa(lbs/in <sup>2</sup> )	TS MPa(lbs/in <sup>2</sup> )	EL (%)	Temp °C(°F)	CVN-Impact Value J (ft.lbs)
As welded with 100% Ar	746 (108,200)	830 (121,000)	21	0 (32) R.T	180 (133) 190 (137)



# ST-92B9

A213 T92(Seamless tube), A335 P92(Seamless pipe), A387 Gr92(Plate), A182/A336 F92(forging), A234 WP92

## Conformances

AWS A5.28/ ASME SFA5.28 ER90S-G

## Applications

- Headers
- Steam piping and turbine casings

## Features

- Good resistance to creep at high temperature
- Tempered martensite structure with alloy carbides in the PWHT

## Current

GTAW: DC -

## Shielding Gas

Ar

## Diameter / Packaging

Diameter	
mm (in)	5kg*1000
1.0 (0.039)	
1.2 (0.045)	
1.6 (1/16)	
2.0 (5/64)	
2.4 (3/32)	√
2.6 (0.10)	
3.2 (1/8)	

## Typical Chemical Composition of the Wire(%)

C	Si	Mn	Cr	Ni	Mo	Shielding Gas
0.10	0.23	0.55	8.82	0.67	0.44	Ar

## Typical Mechanical Properties of All-Weld Metal

	YS MPa(lbs/in <sup>2</sup> )	TS MPa(lbs/in <sup>2</sup> )	EL (%)	Temp °C(°F)	CVN-Impact Value J (ft.-lbs)
As welded with 100% Ar	758 (109,939)	845 (122,557)	21	0 (32) R.T	30 (22) 150 (111)

SMW

SAW

GMW

GTAW

FCW

Non-FERROUS

APPENDIX

# Note

---

# FCAW

## Flux Cored Wire



# SF-71

Type : Rutile



## Conformances

AWS A5.36/ ASME SFA5.36 E71T1-C1A0-CS1  
 JIS Z3313 T49J 0 T1-1 C A-U H10  
 EN ISO 17632-A-T 42 0 P C 1  
 KR 2SMG, 2YSMG(C)H10  
 ABS 2SA, 2YSAH10, 2Y400SA  
 LR 2S, 2YSH10  
 BV SA2M, SA2YM HH, A2M, A2YM HH  
 DNV ILYMS H15

GL 2YH10S  
 NK KSW52Y40G(C)H10  
 TÜV EN ISO 17632-A - T 42 0 P C 1  
 CWB CSA W48 E491T-1-H8  
 CE  
 RS 2, 2YS H10  
 CCS 2YSM H10  
 CRS 2HS, 2Y H5

## Applications

- Shipbuilding
- General fabrication
- Structural fabrication
- Pressure vessels

## Features

- Designed for welding with 100% CO<sub>2</sub> shielding gas
- Good performance and low spatter
- Smooth and stable arc with a fast freezing slag

## Welding Position



1G 2F 3G 4G  
 (PA) (PB) (PF-PG) (PE)

## Current

DC +

## Shielding Gas

100% CO<sub>2</sub>

## Diameter / Packaging

Diameter	Spool				Pac		
	5kg (11lbs)	12.5kg (28lbs)	15kg (33lbs)	20kg (44lbs)	100kg (221lbs)	200kg (441lbs)	250kg (551lbs)
1.0 (0.040)	✓		✓	✓	✓	✓	✓
1.2 (0.045)	✓		✓	✓	✓	✓	✓
1.4 (0.052)	✓	✓	✓	✓	✓	✓	✓
1.6 (1/16)	✓		✓	✓	✓	✓	✓

### Typical Chemical Composition of All-Weld Metal (%)

C	Si	Mn	P	S
0.04	0.49	1.29	0.010	0.009

### Typical Mechanical Properties of All-Weld Metal

YS MPa(lbs/in <sup>2</sup> )	TS MPa(lbs/in <sup>2</sup> )	EL (%)	Temp °C(°F)	CVN-Impact Value J (ft.-lbs)
548 (79,600)	582 (84,500)	28.0	0 (32) -20 (-4)	86 (64) 45 (33)

### Typical Operating Procedures

Diameter, Polarity Shielding Gas	CTWD mm (in)	Wire Feed Speed m/min (in/min)	Voltage (volts)	Approx. Current (amps)	Deposition Rate kg/hr (lb/hr)	Efficiency (%)
<b>1.2mm (0.045 in) DC+</b>						
100% CO <sub>2</sub>	25 (1)	4.5 (175)	18-23	120-160	1.5 (3.3)	86-88
		6.4 (250)	19-25	135-175	2.2 (4.8)	
		7.6 (300)	20-26	150-180	2.5 (5.5)	
		8.9 (350)	23-28	175-205	3.0 (6.6)	
		10.2 (400)	25-30	185-220	3.5 (7.6)	
		11.5 (450)	26-31	220-260	3.8 (8.4)	
		12.8 (500)	27-32	250-290	4.4 (9.6)	
15.3 (600)	28-33	280-320	5.3 (11.6)			
<b>1.4mm (0.052 in) DC+</b>						
100% CO <sub>2</sub>	25 (1)	3.8 (150)	20-25	130-170	1.9 (4.1)	85-88
		5.1 (200)	21-26	160-200	2.5 (5.5)	
		6.4 (250)	22-28	180-230	3.0 (6.6)	
		7.6 (300)	23-29	220-260	4.2 (9.2)	
		10.2 (400)	27-32	270-320	5.5 (12.1)	
		12.8 (500)	28-34	300-350	6.0 (13.2)	
<b>1.6mm (1/16 in) DC+</b>						
100% CO <sub>2</sub>	25 (1)	3.2 (125)	22-25	170-210	2.0 (4.4)	84-87
		3.8 (150)	23-26	180-220	2.5 (5.5)	
		5.1 (200)	25-29	220-260	3.2 (7.0)	
		6.4 (250)	26-32	270-320	4.0 (8.8)	
		7.6 (300)	28-34	300-350	5.0 (11.0)	
		10.2 (400)	34-38	350-400	6.4 (14.0)	

# SF-71LF

Type : Rutile

## Conformances

AWS A5.36/ ASME SFA5.36 E71T1-C1A0-CS1

JIS Z3313 T49J 0 T1-1 C A-U H10

ABS 2YSAH10

LR 2S, 2YSH10

DNV I1YMSH10

NK KSW52G(C)H10

KAW52MG(C)

## Applications

- Shipbuilding
- General fabrication
- Structural fabrication
- Pressure vessels

## Features

- Designed for welding with 100% CO<sub>2</sub> shielding gas
- Low fume
- Smooth and stable arc with a fast freezing slag

## Welding Position



1G 2F 3G 4G  
(PA) (PB) (PF-PG) (PE)

## Current

DC +

## Shielding Gas

100% CO<sub>2</sub>

## Diameter / Packaging

Diameter mm (in)	Spool			Pac		
	5kg (11lbs)	15kg (33lbs)	20kg (44lbs)	100kg (221lbs)	200kg (441lbs)	250kg (551lbs)
1.2 (0.045)	✓	✓	✓		✓	✓
1.4 (0.052)	✓	✓	✓		✓	✓
1.6 (1/16)	✓	✓	✓		✓	✓

### Typical Chemical Composition of All-Weld Metal (%)

C	Si	Mn	P	S
0.03	0.50	1.35	0.009	0.011

### Typical Mechanical Properties of All-Weld Metal

YS MPa(lbs/in <sup>2</sup> )	TS MPa(lbs/in <sup>2</sup> )	EL (%)	Temp °C(°F)	CVN-Impact Value J (ft.-lbs)
550 (79,900)	590 (85,700)	27.0	0 (32) -20 (-4)	90 (66) 42 (31)

### Typical Operating Procedures

Diameter, Polarity Shielding Gas	CTWD mm (in)	Wire Feed Speed m/min (in/min)	Voltage (volts)	Approx. Current (amps)	Deposition Rate kg/hr (lb/hr)	Efficiency (%)
<b>1.2mm (0.045 in) DC+</b>						
100% CO <sub>2</sub>	25 (1)	4.5 (175)	18-23	120-160	1.5 (3.3)	86-88
		6.4 (250)	19-25	135-175	2.2 (4.8)	
		7.6 (300)	20-26	150-180	2.5 (5.5)	
		8.9 (350)	23-28	175-205	3.0 (6.6)	
		10.2 (400)	25-30	185-220	3.5 (7.6)	
		11.5 (450)	26-31	220-260	3.9 (8.6)	
		12.8 (500)	27-32	250-290	4.3 (9.5)	
15.3 (600)	28-33	280-320	5.2 (11.4)			
<b>1.4mm (0.052 in) DC+</b>						
100% CO <sub>2</sub>	25 (1)	3.8 (150)	20-25	130-170	1.9 (4.1)	85-88
		5.1 (200)	21-26	160-200	2.5 (5.5)	
		6.4 (250)	22-28	180-230	3.0 (6.6)	
		7.6 (300)	23-29	220-260	4.2 (9.2)	
		10.2 (400)	24-30	270-320	5.4 (11.9)	
		12.8 (500)	25-31	300-350	6.0 (13.2)	
<b>1.6mm (1/16 in) DC+</b>						
100% CO <sub>2</sub>	25 (1)	3.2 (125)	22-25	170-210	2.0 (4.4)	84-87
		3.8 (150)	23-26	180-220	2.5 (5.5)	
		5.1 (200)	25-29	220-260	3.1 (6.8)	
		6.4 (250)	26-32	270-320	4.0 (8.8)	
		7.6 (300)	28-34	300-350	5.0 (11.0)	
		10.2 (400)	34-38	350-400	6.4 (14.0)	

SMAW

SAW

GMAW

GTAW

FCAW

Non-FERROUS

APPENDIX

# Supercored 71

Type : Rutile



## Conformances

AWS A5.36/ ASME SFA5.36 E71T1-C1A0-CS1  
 JIS Z3313 T49 2 T1-1 C A H10  
 EN ISO 17632-A-T 42 2 PC 1  
 KR 3SMG, 3YSMG(C)H10  
 ABS 3SAH10, 3YSA  
 LR 3S, 3YSH10  
 BV SA3M, SA3YM, A3M, A3YM HH  
 DNV IIIYMS H10

GL 3YH10S  
 NK KSW53Y40G(C)H10  
 TÜV EN ISO 17632-A - T 42 2 PC 1  
 DB DINENISO17632-A-T422PC1  
 CE  
 RINA 3YS H10  
 CRS 3YSH10  
 RS 3YSM H10

## Applications

- Shipbuilding
- General fabrication
- Structural fabrication
- Steel industry

## Features

- Designed for welding with 100% CO<sub>2</sub> shielding gas
- Good performance and low spatter
- Smooth and stable arc with a fast freezing slag

## Welding Position



1G 2F 3G 4G  
 (PA) (PB) (PF-PG) (PE)

## Current

DC +

## Shielding Gas

100% CO<sub>2</sub>

## Diameter / Packaging

Diameter mm (in)	Spool			Pac		
	5kg (11lbs)	15kg (33lbs)	20kg (44lbs)	100kg (221lbs)	200kg (441lbs)	250kg (551lbs)
1.2 (0.045)	✓	✓	✓	✓	✓	
1.4 (0.052)	✓	✓	✓	✓	✓	
1.6 (1/16)	✓	✓	✓	✓	✓	



## Typical Chemical Composition of All-Weld Metal (%)

C	Si	Mn	P	S
0.03	0.51	1.26	0.010	0.011

## Typical Mechanical Properties of All-Weld Metal

YS MPa(lbs/in <sup>2</sup> )	TS MPa(lbs/in <sup>2</sup> )	EL (%)	Temp °C(°F)	CVN-Impact Value J (ft-lbs)
545 (79,100)	572 (83,100)	28.0	0 (32) -20 (-4)	110 (81) 70 (52)

## Typical Operating Procedures

Diameter, Polarity Shielding Gas	CTWD mm (in)	Wire Feed Speed m/min (in/min)	Voltage (volts)	Approx. Current (amps)	Deposition Rate kg/hr (lb/hr)	Efficiency (%)
<b>1.2mm (0.045 in) DC+</b>						
100% CO <sub>2</sub>	25 (1)	4.5 (175)	18~23	120~160	1.5 (3.3)	86~88
		6.4 (250)	19~25	135~175	2.2 (4.8)	
		7.6 (300)	20~26	150~180	2.5 (5.5)	
		8.9 (350)	23~28	175~205	3.0 (6.6)	
		10.2 (400)	25~30	185~220	3.5 (7.6)	
		11.5 (450)	26~31	220~260	3.9 (8.6)	
		12.8 (500)	27~32	250~290	4.3 (9.5)	
15.3 (600)	28~33	280~320	5.2 (11.4)			
<b>1.4mm (0.052 in) DC+</b>						
100% CO <sub>2</sub>	25 (1)	3.8 (150)	20~25	130~170	1.9 (4.1)	85~88
		5.1 (200)	21~26	160~200	2.5 (5.5)	
		6.4 (250)	22~28	180~230	3.0 (6.6)	
		7.6 (300)	23~29	220~260	4.2 (9.2)	
		10.2 (400)	27~32	270~320	5.4 (11.9)	
		12.8 (500)	28~34	300~350	6.0 (13.2)	
<b>1.6mm (1/16 in) DC+</b>						
100% CO <sub>2</sub>	25 (1)	3.2 (125)	22~25	170~210	2.0 (4.4)	84~87
		3.8 (150)	23~26	180~220	2.4 (5.3)	
		5.1 (200)	25~29	220~260	3.1 (6.8)	
		6.4 (250)	26~32	270~320	4.0 (8.8)	
		7.6 (300)	28~34	300~350	5.0 (11.0)	
		10.2 (400)	34~38	350~400	6.3 (13.9)	

# SC-71LH

Type : Rutile



## Conformances

AWS A5.36/ ASME SFA5.36 E71T1-C1A2-CS1

JIS Z3313 T49 3 T1-1 C A-U H5

EN ISO 17632-A-T 42 2 P C 1 H5

KR 3YSG(C)H5

ABS 3YSA H5

LR 3YS H5

BV SA3Y HHH

DNV IIIYMS H5

GL 3YH5S

NK KSW53Y40G(C) H5

TÜV EN ISO 17632-A-T 42 2 P C 1 H5

CE

RS 3Y40MS H5

## Applications

- Shipbuilding
- General fabrication
- Structural fabrication
- Steel industry

## Features

- Designed for welding with 100% CO<sub>2</sub> shielding gas
- Good low Hydrogen level(H5) and crack resistance
- Smooth and stable arc with a fast freezing slag

## Welding Position



1G 2F 3G 4G  
(PA) (PB) (PF-PG) (PE)

## Current

DC +

## Shielding Gas

100% CO<sub>2</sub>

## Diameter / Packaging

Diameter mm (in)	Spool				Pac		
	5kg (11lbs)	12.5kg (28lbs)	15kg (33lbs)	20kg (44lbs)	100kg (221lbs)	200kg (441lbs)	250kg (551lbs)
1.2 (0.045)	✓		✓	✓	✓	✓	✓
1.4 (0.052)	✓	✓	✓	✓	✓	✓	✓
1.6 (1/16)	✓		✓	✓	✓	✓	✓

**Typical Chemical Composition of All-Weld Metal (%)**

C	Si	Mn	P	S
0.06	0.47	1.35	0.014	0.012

**Typical Mechanical Properties of All-Weld Metal**

YS MPa(lbs/in <sup>2</sup> )	TS MPa(lbs/in <sup>2</sup> )	EL (%)	Temp °C(°F)	CVN-Impact Value J (ft.-lbs)
550 (79,900)	590 (85,600)	27.0	-30 (-22)	70 (52)

**Typical Operating Procedures**

Diameter, Polarity Shielding Gas	CTWD mm (in)	Wire Feed Speed m/min (in/min)	Voltage (volts)	Approx. Current (amps)	Deposition Rate kg/hr (lb/hr)	Efficiency (%)
<b>1.2mm (0.045 in) DC+</b>						
100% CO <sub>2</sub>	25 (1)	4.5 (175)	18~23	120~160	1.5 (3.3)	86~88
		6.4 (250)	19~25	135~175	2.2 (4.8)	
		7.6 (300)	20~26	150~180	2.5 (5.5)	
		8.9 (350)	23~28	175~205	3.0 (6.6)	
		10.2 (400)	25~30	185~220	3.5 (7.6)	
		11.5 (450)	26~31	220~260	3.9 (8.6)	
		12.8 (500)	27~32	250~290	4.3 (9.5)	
15.3 (600)	28~33	280~320	5.2 (11.4)			
<b>1.4mm (0.052 in) DC+</b>						
100% CO <sub>2</sub>	25 (1)	3.8 (150)	20~25	130~170	1.9 (4.1)	86~88
		5.1 (200)	21~26	160~200	2.5 (5.5)	
		6.4 (250)	22~28	180~230	3.0 (6.6)	
		7.6 (300)	23~29	220~260	4.2 (9.2)	
		10.2 (400)	27~32	270~320	5.4 (11.9)	
		12.8 (500)	28~34	300~350	6.0 (13.2)	
<b>1.6mm (1/16 in) DC+</b>						
100% CO <sub>2</sub>	25 (1)	3.2 (125)	22~25	170~210	2.0 (4.4)	86~88
		3.8 (150)	23~26	180~220	2.4 (5.3)	
		5.1 (200)	25~29	220~260	3.1 (6.8)	
		6.4 (250)	26~32	270~320	4.0 (8.8)	
		7.6 (300)	28~34	300~350	5.0 (11.0)	
		10.2 (400)	34~38	350~400	6.3 (13.9)	

SWAW

SAW

GMAW

GTAW

FCAW

Non-FERROUS

APPENDIX

# Supercored 71H

Type : Rutile



## Conformances

AWS A5.36/ ASME SFA5.36 E71T1-C1A4-CS1

JIS Z3313 T49 4 T1-1 C A H5

EN ISO 17632-A T42 4 P C 1 H5

KR 4YSMG(C) H10, 3SMG(C) H10 / 3YSMG(C) H10

ABS 4YSA H10, 3YSA H10

LR 4YS H10

BV SA4YM HH, SA3YM HH

DNV IVYSM H5, IIIYMS H5

GL 4YS H10, 3YS H10

NK KSW54G(C) H10

KSW53G(C) H10

TÜV EN ISO 17632-A - T 42 4 P C 1

CWB CSA W48 E491T-9J-H8

CE

DB DIN EN ISO 17632-A-T 42 4 P C 1

CCS 3YSM H10, 4YSM H10

RINA 3YS H10

RS 4Y40SM H5, 3Y40SM H5

NAKS

## Applications

- Shipbuilding
- Offshore Structure
- Structural fabrication
- Pressure vessels

## Features

- Low temperature service steel
- Designed for welding with 100% CO<sub>2</sub> shielding gas
- Smooth and stable arc with a fast freezing slag

## Welding Position



1G 2F 3G 4G  
(PA) (PB) (PF-PG) (PE)

## Current

DC +

## Shielding Gas

100% CO<sub>2</sub>

## Diameter / Packaging

Diameter mm (in)	Spool			Pac		
	5kg (11lbs)	15kg (33lbs)	20kg (44lbs)	100kg (221lbs)	200kg (441lbs)	250kg (551lbs)
1.2 (0.045)	✓	✓	✓	✓	✓	✓
1.4 (0.052)	✓	✓	✓	✓	✓	✓
1.6 (1/16)	✓	✓	✓	✓	✓	✓

Typical Chemical Composition of All-Weld Metal (%)

C	Si	Mn	P	S	Ni
0.03	0.46	1.36	0.008	0.011	0.40

Typical Mechanical Properties of All-Weld Metal

YS MPa(lbs/in <sup>2</sup> )	TS MPa(lbs/in <sup>2</sup> )	EL (%)	Temp °C(°F)	CVN-Impact Value J (ft.-lbs)
550 (79,900)	570 (82,800)	27.0	-30 (-22) -40 (-40)	90 (66) 60 (44)

Typical Operating Procedures

Diameter, Polarity Shielding Gas	CTWD mm (in)	Wire Feed Speed m/min (in/min)	Voltage (volts)	Approx. Current (amps)	Deposition Rate kg/hr (lb/hr)	Efficiency (%)	
<b>1.2mm (0.045 in) DC+</b>							
100% CO <sub>2</sub>	25 (1)	All Position					85-88
		4.3 (175)	20-25	100-130	1.6 (3.5)		
		5.6 (220)	21-26	120-150	2.0 (4.5)		
		7.0 (275)	22-27	130-160	2.5 (5.5)		
		8.3 (325)	23-28	160-190	2.9 (6.5)		
		8.9 (350)	24-29	170-200	3.2 (7.0)		
		10.2 (400)	25-30	200-230	3.6 (8.0)		
		Flat & Horizontal					
		11.4 (450)	26-31	210-240	4.1 (9.1)		
		12.1 (475)	27-32	230-260	4.3 (9.5)		
		13.3 (525)	28-33	250-280	4.7 (10.4)		
		<b>1.4mm (0.052 in) DC+</b>					
100% CO <sub>2</sub>	25 (1)	All Position					86-88
		3.8 (150)	22-27	130-160	1.8 (3.9)		
		5.1 (200)	23-28	140-170	2.4 (5.2)		
		6.4 (250)	24-29	160-190	2.9 (6.5)		
		7.6 (300)	26-31	180-210	3.5 (7.8)		
		8.9 (350)	27-32	200-230	4.1 (9.1)		
		9.5 (375)	28-33	220-250	4.4 (9.8)		
		Flat & Horizontal					
		10.8 (425)	30-35	240-270	5.0 (11.1)		
		12.1 (475)	31-36	260-290	5.6 (12.4)		
		12.7 (500)	32-37	310-340	5.9 (13.0)		
		<b>1.6mm (1/16 in) DC+</b>					
100% CO <sub>2</sub>	25 (1)	All Position					86-88
		3.8 (150)	21-27	180-210	2.5 (5.5)		
		4.4 (175)	23-28	220-250	2.9 (6.4)		
		5.1 (200)	24-29	260-290	3.3 (7.3)		
		5.7 (225)	25-31	280-300	3.7 (8.2)		
		6.4 (250)	27-34	300-330	4.2 (9.2)		
		7.6 (300)	29-36	330-360	5.0 (11.0)		
		Flat & Horizontal					
		8.3 (325)	31-38	360-390	5.4 (11.9)		
		8.9 (350)	32-39	390-420	5.8 (12.8)		
		11.4 (450)	34-39	420-450	7.5 (16.5)		

SMW

SAW

GMAW

GTAW

FCAW

Non-FERROUS

APPENDIX

# SC-71HJ

Type : Rutile

## Conformances

AWS A5.36/ ASME SFA5.36 E71T1-C1A4-CS1

JIS Z3313 T49 4 T1-1 C A

EN ISO 17632-A T42 4 P C 1 H10

KR 4Y40SG(C)H10

ABS 4Y400SA H10

LR 4Y40S H10

BV SA4Y40 HH

DNV IVY40MS H10

GL 4Y40H10S

NK KSW54Y40G(C)H10

## Applications

- Shipbuilding
- Offshore Structure
- Structural fabrication
- Pressure vessels

## Features

- Designed for welding with 100% CO<sub>2</sub> shielding gas
- Good bead appearance
- Smooth and stable arc with a fast freezing slag
- Good performance in all position

## Welding Position



1G 2F 3G 4G  
(PA) (PB) (PF) (PE)

## Current

DC +

## Shielding Gas

100% CO<sub>2</sub>

## Diameter / Packaging

Diameter	Spool			Pac		
	5kg (11lbs)	15kg (33lbs)	20kg (44lbs)	100kg (221lbs)	200kg (441lbs)	250kg (551lbs)
1.2 (0.045)	✓	✓	✓	✓	✓	
1.4 (0.052)	✓	✓	✓	✓	✓	
1.6 (1/16)	✓	✓	✓	✓	✓	

**Typical Chemical Composition of All-Weld Metal (%)**

C	Si	Mn	P	S	Ni
0.04	0.45	1.30	0.008	0.011	0.40

**Typical Mechanical Properties of All-Weld Metal**

YS MPa(lbs/in <sup>2</sup> )	TS MPa(lbs/in <sup>2</sup> )	EL (%)	Temp °C(°F)	CVN-Impact Value J (ft.-lbs)
560 (81,300)	580 (84,200)	27.5	-40 (-40)	70 (52)

**Typical Operating Procedures**

Diameter, Polarity Shielding Gas	CTWD mm (in)	Wire Feed Speed m/min (in/min)	Voltage (volts)	Approx. Current (amps)	Deposition Rate kg/hr (lb/hr)	Efficiency (%)	
<b>1.2mm (0.045 in) DC+</b>							
100% CO <sub>2</sub>	25 (1)	<b>All Position</b>					85-88
		4.4 (175)	20-25	100-130	1.6 (3.5)		
		5.7 (225)	21-26	120-150	2.0 (4.5)		
		7.0 (275)	22-27	130-160	2.5 (5.5)		
		8.3 (325)	23-28	160-190	2.9 (6.5)		
		8.9 (350)	24-29	170-200	3.2 (7.0)		
		10.2 (400)	25-30	200-230	3.6 (8.0)		
		<b>Flat &amp; Horizontal</b>					
		11.4 (450)	26-31	210-240	4.1 (9.1)		
		12.1 (475)	27-32	230-260	4.3 (9.5)		
		13.3 (525)	28-33	250-280	4.7 (10.4)		
		<b>1.4mm (0.052 in) DC+</b>					
100% CO <sub>2</sub>	25 (1)	<b>All Position</b>					86-88
		3.8 (150)	22-27	130-160	1.8 (3.9)		
		5.1 (200)	23-28	140-170	2.4 (5.2)		
		6.4 (250)	24-29	160-190	2.9 (6.5)		
		7.6 (300)	26-31	180-210	3.5 (7.8)		
		8.9 (350)	27-32	200-230	4.1 (9.1)		
		9.5 (375)	28-33	220-250	4.4 (9.8)		
		<b>Flat &amp; Horizontal</b>					
		10.8 (425)	30-35	240-270	5.0 (11.1)		
		12.1 (475)	31-36	260-290	5.6 (12.4)		
		12.7 (500)	32-37	310-340	5.9 (13.0)		
		<b>1.6mm (1/16 in) DC+</b>					
100% CO <sub>2</sub>	25 (1)	<b>All Position</b>					86-88
		3.8 (150)	21-27	180-210	2.5 (5.5)		
		4.4 (175)	23-28	220-250	2.9 (6.4)		
		5.1 (200)	24-29	260-290	3.3 (7.3)		
		5.7 (225)	25-31	280-300	3.7 (8.2)		
		6.4 (250)	27-34	300-330	4.2 (9.2)		
		7.6 (300)	29-36	330-360	5.0 (11.0)		
		<b>Flat &amp; Horizontal</b>					
		8.3 (325)	31-38	360-390	5.4 (11.9)		
		8.9 (350)	32-39	390-420	5.8 (12.8)		
		11.4 (450)	34-39	420-450	7.5 (16.5)		

SMW  
SAW  
GMAW  
GTAW  
FCAW  
Non-FERROUS  
APPENDIX

# Supercored 71MAG

Type : Rutile



## Conformances

AWS A5.36/ ASME SFA5.36 E71T1-M21A2-CS1

JIS Z3313 T49 3 T1-1 M A-U H10

EN ISO 17632-A-T 42 3 P M 1

ABS 3SAH10, 3YSA

LR 3S, 3YSH10

BV SA3M, SA3YM HH, A3M, A3YM

DNV IIIYMS H10

GL 3YH10S

TÜV EN ISO 17632-A - T 46 3 P M 1

CE

DB DIN EN ISO 17632-A-T 46 3 P M 1

RINA 3YS H10

CWB CSA W48 E491T-9M-H8

## Applications

- Shipbuilding
- Civil construction
- General fabrication

## Features

- Designed for welding with 75~80% Argon/ balance CO<sub>2</sub> shielding gas
- Good arc performance and bead appearance
- Low spatter

## Welding Position



1G 2F 3G 4G  
(PA) (PB) (PF-PG) (PE)

## Current

DC +

## Shielding Gas

Ar + 20~25% CO<sub>2</sub>

## Diameter / Packaging

Diameter	Spool			Pac		
	5kg (11lbs)	15kg (33lbs)	20kg (44lbs)	100kg (221lbs)	200kg (441lbs)	250kg (551lbs)
1.0 (0.040)	✓	✓	✓		✓	✓
1.2 (0.045)	✓	✓	✓		✓	✓
1.4 (0.052)	✓	✓	✓		✓	✓
1.6 (1/16)	✓	✓	✓		✓	✓



## Typical Chemical Composition of All-Weld Metal (%)

C	Si	Mn	P	S
0.04	0.54	1.25	0.011	0.012

## Typical Mechanical Properties of All-Weld Metal

YS MPa(lbs/in <sup>2</sup> )	TS MPa(lbs/in <sup>2</sup> )	EL (%)	Temp °C(°F)	CVN-Impact Value J (ft.-lbs)
580 (84,200)	600 (87,100)	28.0	-30 (-22)	60 (44)

## Typical Operating Procedures

Diameter, Polarity Shielding Gas	CTWD mm (in)	Wire Feed Speed m/min (in/min)	Voltage (volts)	Approx. Current (amps)	Deposition Rate kg/hr (lb/hr)	Efficiency (%)
<b>1.2mm (0.045 in) DC+</b>						
80% Ar + 20% CO <sub>2</sub>	25 (1)	4.5 (175)	17~22	120~160	1.5 (3.3)	86~88
		6.4 (250)	18~24	135~175	2.2 (4.8)	
		7.6 (300)	19~25	150~180	2.5 (5.5)	
		8.9 (350)	22~27	175~205	3.0 (6.6)	
		10.2 (400)	24~29	185~220	3.5 (7.6)	
		11.5 (450)	25~30	220~260	3.8 (8.4)	
		12.8 (500)	26~31	250~290	4.4 (9.6)	
15.3 (600)	27~32	280~320	5.3 (11.6)			
<b>1.4mm (0.052 in) DC+</b>						
80% Ar + 20% CO <sub>2</sub>	25 (1)	3.8 (150)	19~24	130~170	1.9 (4.1)	86~89
		5.1 (200)	20~25	160~200	2.5 (5.5)	
		6.4 (250)	21~27	180~230	3.0 (6.6)	
		7.6 (300)	22~28	220~260	4.2 (9.2)	
		10.2 (400)	26~31	270~320	5.5 (12.1)	
		12.8 (500)	27~33	300~350	6.0 (13.2)	
<b>1.6mm (1/16 in) DC+</b>						
80% Ar + 20% CO <sub>2</sub>	25 (1)	3.2 (125)	21~24	170~210	2.0 (4.4)	86~89
		3.8 (150)	22~25	180~220	2.5 (5.5)	
		5.1 (200)	24~28	220~260	3.2 (7.0)	
		6.4 (250)	25~31	270~320	4.0 (8.8)	
		7.6 (300)	27~33	300~350	5.0 (11.0)	
		10.2 (400)	33~37	350~400	6.4 (14.0)	

# SC-71LHM Cored

Type : Rutile



## Conformances

AWS A5.36/ ASME SFA5.36 E71T1-M21A2-CS1  
 JIS Z3313 T49 3 T1-1 M A-U H5  
 EN ISO 17632-A-T 46 3 P M 1 H5  
 ABS 3YSA H5  
 CWB CSA W48 E49 1T-9M-H4  
 LR 3YS H5

BV SA3Y HHH  
 DNV IIIYMSH5  
 GL 3YH5S  
 TÜV EN ISO 17632-A-T 46 3 P M 1 H5  
 DB EN ISO 17632-A-T 46 3 P M 1 H5  
 CE

## Applications

- Shipbuilding
- Steel industry
- General fabrication

## Features

- Designed for welding with 75~80% Argon/ balance CO<sub>2</sub> shielding gas
- Good arc performance and fast freezing slag
- Low hydrogen level(H5) and good crack resistance

## Welding Position



1G 2F 3G 4G  
 (PA) (PB) (PF-PG) (PE)

## Current

DC +

## Shielding Gas

Ar + 20~25% CO<sub>2</sub>

## Diameter / Packaging

Diameter mm (in)	Spool			Pac		
	5kg (11lbs)	15kg (33lbs)	20kg (44lbs)	100kg (221lbs)	200kg (441lbs)	250kg (551lbs)
1.2 (0.045)	✓	✓	✓			
1.4 (0.052)	✓	✓	✓			
1.6 (1/16)	✓	✓	✓			

**Typical Chemical Composition of All-Weld Metal (%)**

C	Si	Mn	P	S
0.05	0.50	1.20	0.012	0.015

**Typical Mechanical Properties of All-Weld Metal**

YS MPa(lbs/in <sup>2</sup> )	TS MPa(lbs/in <sup>2</sup> )	EL (%)	Temp °C(°F)	CVN-Impact Value J (ft.-lbs)
580 (84,200)	600 (87,100)	28.0	-30 (-22)	80 (59)

**Typical Operating Procedures**

Diameter, Polarity Shielding Gas	CTWD mm (in)	Wire Feed Speed m/min (in/min)	Voltage (volts)	Approx. Current (amps)	Deposition Rate kg/hr (lb/hr)	Efficiency (%)
<b>1.2mm (0.045 in) DC+</b>						
80% Ar + 20% CO <sub>2</sub>	25 (1)	4.5 (175)	17~22	120~160	1.5 (3.3)	86~88
		6.4 (250)	18~24	135~175	2.2 (4.8)	
		7.6 (300)	19~25	150~180	2.5 (5.5)	
		8.9 (350)	22~27	175~205	3.0 (6.6)	
		10.2 (400)	24~29	185~220	3.5 (7.6)	
		11.5 (450)	25~30	220~260	3.8 (8.4)	
		12.8 (500)	26~31	250~290	4.4 (9.6)	
15.3 (600)	27~32	280~320	5.3 (11.6)			
<b>1.4mm (0.052 in) DC+</b>						
80% Ar + 20% CO <sub>2</sub>	25 (1)	3.8 (150)	19~24	130~170	1.9 (4.1)	86~88
		5.1 (200)	20~25	160~200	2.5 (5.5)	
		6.4 (250)	21~27	180~230	3.0 (6.6)	
		7.6 (300)	22~28	220~260	4.2 (9.2)	
		10.2 (400)	26~31	270~320	5.5 (12.1)	
		12.8 (500)	27~33	300~350	6.0 (13.2)	
<b>1.6mm (1/16 in) DC+</b>						
80% Ar + 20% CO <sub>2</sub>	25 (1)	3.2 (125)	21~24	170~210	2.0 (4.4)	86~88
		3.8 (150)	22~25	180~220	2.5 (5.5)	
		5.1 (200)	24~28	220~260	3.2 (7.0)	
		6.4 (250)	25~31	270~320	4.0 (8.8)	
		7.6 (300)	27~33	300~350	5.0 (11.0)	
		10.2 (400)	33~37	350~400	6.4 (14.0)	

SWAW

SAW

GMAW

GTAW

FCAW

Non-FERROUS

APPENDIX

# SF-71MC

Type : Rutile



## Conformances

AWS A5.36/ ASME SFA5.36 E71T1-C1A2-CS2  
E71T1-M21A2-CS2

EN ISO 17632-A-T 46 3 P M 1

EN ISO 17632-A-T 46 2 P C 1

ABS 3YSA H10

LR 3YS H10

BV SA3YM HH

DNV IIIYMS H10

TÜV EN ISO 17632-A-T 46 3 P M(C) 1 H10

DB EN ISO 17632-A-T 46 3 P M(C) 1 H10

CWB CSA W48 E49 1T-1(M)  
/-9(M)/-12(M)-H8

CE

## Applications

- Shipbuilding
- Structural fabrication
- General fabrication
- Pipe line
- Offshore structure

## Features

- Low spatter and excellent performance
- Good arc performance and fast freezing slag
- Use 100% CO<sub>2</sub> gas or Ar-CO<sub>2</sub> mixture(Dual gas)
- Better performance in V-up position

## Welding Position

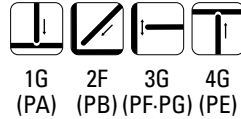

## Current

DC +

## Shielding Gas

100% CO<sub>2</sub>  
Ar + 20~25% CO<sub>2</sub>

## Diameter / Packaging

Diameter mm (in)	Spool			Pac		
	5kg (11lbs)	15kg (33lbs)	20kg (44lbs)	100kg (221lbs)	200kg (441lbs)	250kg (551lbs)
1.2 (0.045)	✓	✓	✓	✓	✓	✓
1.4 (0.052)	✓	✓	✓	✓	✓	✓
1.6 (1/16)	✓	✓	✓	✓	✓	✓

### Typical Chemical Composition of All-Weld Metal (%)

	C	Si	Mn	P	P
100% CO <sub>2</sub>	0.04	0.40	1.20	0.010	0.012

### Typical Mechanical Properties of All-Weld Metal

	YS MPa(lbs/in <sup>2</sup> )	TS MPa(lbs/in <sup>2</sup> )	EL (%)	Temp °C(°F)	CVN-Impact Value J (ft-lbs)
100% CO <sub>2</sub>	510 (74,000)	550 (79,900)	28.0	-20 (-4)	95 (70)
75% Ar + 25% CO <sub>2</sub>	540 (78,400)	605 (87,700)	28.0	-20 (-4)	110 (81)

### Typical Operating Procedures

Diameter, Polarity Shielding Gas	CTWD mm (in)	Wire Feed Speed m/min (in/min)	Voltage (volts)	Approx. Current (amps)	Deposition Rate kg/hr (lb/hr)	Efficiency (%)
<b>1.2mm (0.045 in) DC+</b>						
100% CO <sub>2</sub>	25 (1)	4.5 (175)	17~22	120~160	1.5 (3.3)	86~88
		6.4 (250)	18~24	135~175	2.2 (4.8)	
		7.6 (300)	19~25	150~180	2.5 (5.5)	
		8.9 (350)	22~27	175~205	3.0 (6.6)	
		10.2 (400)	24~29	185~220	3.5 (7.6)	
		11.5 (450)	25~30	220~260	3.8 (8.4)	
		15.3 (600)	27~32	280~320	5.3 (11.6)	
75% Ar + 25% CO <sub>2</sub>	25 (1)	4.5 (175)	18~23	120~160	1.5 (3.3)	86~88
		6.4 (250)	19~25	135~175	2.2 (4.8)	
		7.6 (300)	20~26	150~180	2.5 (5.5)	
		8.9 (350)	23~28	175~205	3.0 (6.6)	
		10.2 (400)	25~30	185~220	3.5 (7.6)	
		11.5 (450)	26~31	220~260	3.9 (8.6)	
		12.8 (500)	27~32	250~290	4.3 (9.5)	
		15.3 (600)	28~33	280~320	5.2 (11.4)	

# SC-71MJ

Type : Rutile

## Conformances

AWS A5.36/ ASME SFA5.36 E71T1-M21A4-CS1

JIS Z3313 T49 4 T1-1 M A-U H5

EN ISO 17632-A T46 4 P M 1 H5

ABS 4YSA, 4Y400SA H5

LR 4Y40 H5

BV SA4Y, SA4Y40 HHH

DNV IVY40MS (H5), IVYMS

## Applications

- Shipbuilding
- Pipe line
- Offshore structure

## Features

- Good impact value at low temperature
- Smooth and stable arc with a fast freezing slag
- Low hydrogen level(H5)
- Designed for welding with Ar-CO<sub>2</sub> mixture

## Welding Position



1G 2F 3G 4G  
(PA) (PB) (PF) (PE)

## Current

DC +

## Shielding Gas

Ar + 20~25% CO<sub>2</sub>

## Diameter / Packaging

Diameter mm (in)	Spool			Pac		
	5kg (11lbs)	15kg (33lbs)	20kg (44lbs)	100kg (221lbs)	200kg (441lbs)	250kg (551lbs)
1.2 (0.045)	✓	✓				
1.4 (0.052)	✓	✓				
1.6 (1/16)	✓	✓				

**Typical Chemical Composition of All-Weld Metal (%)**

C	Si	Mn	P	S	Ni
0.06	0.30	1.10	0.012	0.011	0.42

**Typical Mechanical Properties of All-Weld Metal**

YS MPa(lbs/in <sup>2</sup> )	TS MPa(lbs/in <sup>2</sup> )	EL (%)	Temp °C(°F)	CVN-Impact Value J (ft.-lbs)
545 (79,100)	583 (84,500)	25.0	-30 (-22) -40 (-40)	126 (93) 80 (59)

**Typical Operating Procedures**

Diameter, Polarity Shielding Gas	CTWD mm (in)	Wire Feed Speed m/min (in/min)	Voltage (volts)	Approx. Current (amps)	Deposition Rate kg/hr (lb/hr)	Efficiency (%)	
<b>1.2mm (0.045 in) DC+</b>							
80% Ar + 20% CO <sub>2</sub>	25 (1)	All Position					86-88
		4.4 (175)	20-25	110-140	1.6 (3.5)		
		5.7 (225)	21-26	120-150	2.0 (4.5)		
		7.0 (275)	22-27	130-160	2.5 (5.5)		
		8.3 (325)	22-27	160-190	2.9 (6.5)		
		8.9 (350)	23-28	170-200	3.2 (7.0)		
		10.2 (400)	24-29	200-230	3.6 (8.0)		
		Flat & Horizontal					
		11.4 (450)	25-31	210-240	4.1 (9.1)		
		12.1 (475)	26-32	230-260	4.3 (9.5)		
13.3 (525)	27-33	250-280	4.7 (10.4)				
<b>1.4mm (0.052 in) DC+</b>							
80% Ar + 20% CO <sub>2</sub>	25 (1)	All Position					86-88
		3.8 (150)	22-27	120-150	1.8 (3.9)		
		4.4 (175)	21-26	130-160	2.1 (4.6)		
		5.1 (200)	22-27	160-190	2.4 (5.2)		
		5.7 (225)	23-28	180-210	2.7 (5.9)		
		6.4 (250)	24-29	200-230	2.9 (6.5)		
		7.6 (300)	25-30	220-250	3.5 (7.8)		
		Flat & Horizontal					
		8.9 (350)	28-32	260-290	4.1 (9.1)		
		11.4 (450)	29-34	310-330	5.3 (11.7)		
<b>1.6mm (1/16 in) DC+</b>							
80% Ar + 20% CO <sub>2</sub>	25 (1)	All Position					86-88
		3.8 (150)	21-26	170-200	2.5 (5.5)		
		4.4 (175)	22-27	180-210	2.9 (6.4)		
		5.1 (200)	22-28	200-230	3.3 (7.3)		
		5.7 (225)	24-29	230-260	3.7 (8.2)		
		6.4 (250)	25-30	250-280	4.2 (9.2)		
		7.6 (300)	26-31	280-310	5.0 (11.0)		
		Flat & Horizontal					
		8.3 (325)	27-32	300-330	5.4 (11.9)		
		8.9 (350)	28-33	330-360	5.8 (12.8)		
10.2 (450)	29-34	380-410	6.6 (14.6)				

SWAW  
SAW  
GMAW  
GTAW  
FCAW  
Non-FERROUS  
APPENDIX

# SF-70MX

Type : Semi-Metal

## Conformances

AWS A5.36/ ASME SFA5.36 E70T1-C1A0-CS1

JIS Z3313 T49J 0 T15-0 C A-U H10

EN ISO 17632-A-T 42 0 R C 3

KR 2SG, 2YSG (C1) H10, 2MG, 2YMG(C1) H10

ABS 2SA, 2YSAH10, 2Y400SA

LR 2S, 2YSH10

BV SA2YM HH

DNV IIYMSH10

GL 2YH10S

NK KSW2G, KSW52Y40G(C)H10  
KAW2MG, KAW52MG(C)H10

CCS 2YSM H10

CRS 2HSM, 2YHSM

RINA 2YS H10

CWB CSA W48 E492T-1-H8

## Applications

- Shipbuilding
- Structural fabrication
- General fabrication
- Transportation equipment

## Features

- Designed for welding with 100% CO<sub>2</sub> shielding gas
- Good high deposition rate
- Good penetration and good arc stability
- Low spatter and soft arc
- Good anti-porosity

## Welding Position



1G 2F  
(PA) (PB)

## Current

DC +

## Shielding Gas

100% CO<sub>2</sub>

## Diameter / Packaging

Diameter mm (in)	Spool			Pac		
	5kg (11lbs)	15kg (33lbs)	25kg (55lbs)	100kg (220lbs)	250kg (551lbs)	300kg (661lbs)
1.2 (0.045)	✓	✓		✓	✓	✓
1.4 (0.052)	✓	✓		✓	✓	✓
1.6 (1/16)	✓	✓		✓	✓	✓
2.4 (3/32)			✓	✓	✓	



## Typical Chemical Composition of All-Weld Metal (%)

C	Si	Mn	P	S
0.05	0.5	1.5	0.011	0.013

## Typical Mechanical Properties of All-Weld Metal

YS MPa(lbs/in <sup>2</sup> )	TS MPa(lbs/in <sup>2</sup> )	EL (%)	Temp °C(°F)	CVN-Impact Value J (ft.-lbs)
560 (81,300)	590 (85,700)	28	-20 (-4)	45 (33)

## Typical Operating Procedures

Diameter, Polarity Shielding Gas	CTWD mm (in)	Wire Feed Speed m/min (in/min)	Voltage (volts)	Approx. Current (amps)	Deposition Rate kg/hr (lb/hr)	Efficiency (%)
<b>1.2mm (0.045 in) DC+</b>						
100% CO <sub>2</sub>	25 (1)	11.5 (450)	24~28	200~240	4.1 (9.0)	85~87
		12.6 (500)	27~29	220~260	4.5 (10.0)	87~89
		14.3 (560)	29~33	240~280	5.0 (10.9)	87~89
		15.4 (610)	29~33	260~300	5.4 (11.9)	89~90
<b>1.4mm (0.052 in) DC+</b>						
100% CO <sub>2</sub>	25 (1)	9.6 (380)	24~28	230~270	4.4 (9.8)	87~89
		10.7 (420)	25~29	250~290	5.0 (11.1)	87~89
		12.2 (480)	29~33	270~310	5.6 (12.4)	88~90
		12.8 (500)	30~34	300~340	5.9 (13.0)	88~90
		13.1 (515)	30~34	330~370	6.1 (13.4)	88~90
<b>1.6mm (1/16 in) DC+</b>						
100% CO <sub>2</sub>	25 (1)	6.4 (250)	26~30	250~290	3.8 (8.5)	86~88
		7.6 (300)	28~32	270~310	4.5 (10.0)	87~89
		8.9 (350)	30~34	300~340	5.5 (12.1)	87~89
		10.2 (400)	33~37	340~380	6.3 (13.9)	89~91
<b>2.4mm (3/32 in) DC+</b>						
100% CO <sub>2</sub>	25 (1)	3.2 (125)	23~28	335	4.9 (10.8)	86~88
		5.1 (200)	27~32	445	7.6 (16.7)	88~89
		6.4 (250)	29~34	500	9.6 (21.3)	89~92
		7.6 (300)	31~36	590	11.8 (26.0)	89~92

# SC-70H Cored

Type : Semi-Metal

## Conformances

AWS A5.36/ ASME SFA5.36 E70T1-C1A2-CS1

JIS Z3313 T49 3 T 15-0 C A H10

EN ISO 17632-A-T 42 2 R C 3

ABS 3YSA H10

LR 3YS H10

GL 3YH10S

CCS 3YSM H10

CWB CSA W48 E492T-9-H8

## Applications

- Shipbuilding
- Structural fabrication
- Machinery
- Heavy equipment
- Transportation equipment

## Features

- High deposition in the flat and horizontal positions
- Designed for welding with 100% CO<sub>2</sub> shielding gas
- Low spatter and soft arc
- Good anti-porosity

## Welding Position



1G 2F  
(PA) (PB)

## Current

DC +

## Shielding Gas

100% CO<sub>2</sub>

## Diameter / Packaging

Diameter mm (in)	Spool			Pac		
	5kg (11lbs)	15kg (33lbs)	25kg (44lbs)	100kg (220lbs)	250kg (551lbs)	300kg (661lbs)
1.2 (0.045)		√		√	√	√
1.4 (0.052)		√		√	√	√
1.6 (1/16)		√		√	√	√
2.0 (5/64)			√	√		
2.4 (3/32)			√	√		
3.2 (1/8)			√	√		

**Typical Chemical Composition of All-Weld Metal (%)**

C	Si	Mn	P	S
0.05	0.56	1.48	0.014	0.010

**Typical Mechanical Properties of All-Weld Metal**

YS MPa(lbs/in <sup>2</sup> )	TS MPa(lbs/in <sup>2</sup> )	EL (%)	Temp °C(°F)	CVN-Impact Value J (ft.-lbs)
495 (71,900)	580 (84,100)	28	-30 (-22)	51 (38)

**Typical Operating Procedures**

Diameter, Polarity Shielding Gas	CTWD mm (in)	Wire Feed Speed m/min (in/min)	Voltage (volts)	Approx. Current (amps)	Deposition Rate kg/hr (lb/hr)	Efficiency (%)
<b>1.2mm (0.045 in) DC+</b>						
100% CO <sub>2</sub>	25 (1)	10.2 (400)	24-28	220-240	4.7 (10.4)	89-91
		12.8 (500)	28-32	230-270	5.6 (12.3)	89-91
		15.3 (600)	30-34	280-320	6.3 (13.9)	90-92
<b>1.4mm (0.052 in) DC+</b>						
100% CO <sub>2</sub>	25 (1)	12.2 (480)	30-34	280-320	5.7 (12.6)	89-91
		12.7 (500)	30-34	310-330	5.9 (13.0)	89-91
		13.0 (512)	34-38	330-370	6.3 (13.9)	90-92
<b>1.6mm (1/16 in) DC+</b>						
100% CO <sub>2</sub>	25 (1)	7.7 (300)	30-34	280-320	5.1 (11.2)	89-91
		8.8 (350)	32-38	330-370	5.9 (13.0)	89-91
		10.3 (400)	34-40	380-420	6.6 (14.6)	90-92
<b>2.0mm (5/64 in) DC+</b>						
100% CO <sub>2</sub>	25 (1)	6.4 (250)	31-35	330-370	6.0 (13.2)	89-91
		7.7 (300)	32-36	380-420	7.1 (15.6)	92-93
		10.0 (390)	34-38	430-470	9.8 (21.6)	92-93
<b>2.4mm (3/32 in) DC+</b>						
100% CO <sub>2</sub>	25 (1)	4.5 (180)	31-35	380-420	6.4 (14.1)	89-91
		5.2 (200)	32-36	430-470	7.6 (16.8)	92-93
		6.4 (250)	34-38	480-520	9.6 (21.2)	92-93
<b>3.2mm (1/8 in) DC+</b>						
100% CO <sub>2</sub>	25 (1)	2.5 (98)	30-34	360-400	6.6 (14.6)	89-91
		2.8 (110)	30-34	380-420	7.2 (15.9)	92-93
		3.3 (130)	32-36	460-500	10.3 (22.7)	92-93

SWAW

SAW

GMAW

GTAW

FCAW

Non-FERROUS

APPENDIX

# Supercored 70MXH

Type : Semi-Metal

## Conformances

AWS A5.36/ ASME SFA5.36 E70T1-C1A2-CS1  
 JIS Z3313 T49J 2 T15-0 C A-U H5  
 EN ISO 17632-A-T 42 2 R C 3 H5  
 KR 3YSG(C)HHH, 3YMG(C)HHH  
 ABS 3SAH5, 3YSA  
 LR 3YSH5  
 BV SA3YM, A3YM HHH

DNV IIIYMS H5  
 GL 3YH5S  
 NK KSW53G(C)H5  
 KAW53MG(C)H5  
 CCS 3YSM H5  
 RINA 3YS H5

## Applications

- Shipbuilding
- Structural fabrication
- General fabrication
- Heavy equipment
- Offshore structure

## Features

- Designed for welding with 100% CO<sub>2</sub> shielding gas
- High speed single or twin tandem welding
- Low hydrogen level (H5)
- Good anti-porosity to zinc primer

## Welding Position

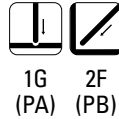

## Current

DC +

## Shielding Gas

100% CO<sub>2</sub>

## Diameter / Packaging

Diameter	Spool			Pac		
	5kg (11lbs)	15kg (33lbs)	20kg (44lbs)	250kg (551lbs)	300kg (661lbs)	500kg (771lbs)
1.4 (0.052)		✓	✓	✓	✓	✓
1.6 (1/16)		✓	✓	✓	✓	✓

## Typical Chemical Composition of All-Weld Metal (%)

C	Si	Mn	P	S
0.05	0.55	1.65	0.013	0.010

## Typical Mechanical Properties of All-Weld Metal

YS MPa(lbs/in <sup>2</sup> )	TS MPa(lbs/in <sup>2</sup> )	EL (%)	Temp °C(°F)	CVN-Impact Value J (ft.-lbs)
540 (78,400)	620 (90,000)	28	-30 (-22)	50 (37)

## Typical Operating Procedures

Diameter, Polarity Shielding Gas	CTWD mm (in)	Wire Feed Speed m/min (in/min)	Voltage (volts)	Approx. Current (amps)	Deposition Rate kg/hr (lb/hr)	Efficiency (%)
<b>1.4mm (0.052 in) DC+</b>						
100% CO <sub>2</sub>	25 (1)	12.2 (480)	29-33	280-320	5.6 (12.4)	90-92
		13.1 (515)	34-38	330-370	6.1 (13.4)	91-93
		15.0 (590)	36-40	380-420	6.4 (14.1)	91-93
<b>1.6mm (1/16 in) DC+</b>						
100% CO <sub>2</sub>	25 (1)	7.6 (300)	31-35	280-320	4.9 (10.8)	87-89
		8.9 (350)	34-38	330-370	5.5 (12.1)	90-91
		10.2 (400)	36-40	380-420	6.3 (13.9)	90-91
		11.8 (500)	40-44	430-470	7.7 (17.0)	91-92

SWAW

SAW

GMAW

GTAW

FCAW

Non-FERROUS

APPENDIX

# SC-70T Cored

Type : Metal-Cored



## Conformances

AWS A5.36/ ASME SFA5.36 E70T15-C1A0-CS1  
E70T15-M21A2-CS1

JIS Z3313 T49 2 T15-1 CA  
Z3313 T49 3 T15-1 MA

EN ISO 17632-A-T 42 2 M C 1

EN ISO 17632-A-T 46 2 M M 1 H5

ABS 3YSA H10, 3YSA (C)

LR 3YS H10 (C1), 3YS H5 (M21)

BV SA3YMH (C1), SA3YHH (M21)

DNV IIYMS H10 (C1), IIYMS H5 (M21)

GL 3YH10S (C1), 3Y H5S (M21)

TÜV EN ISO 17632-A T46 2 M M / T42 2 M C

DB EN ISO 17632-A T46 2 M M 1 / T42 2 M C 1

CWB CSA W48 E49 1C-3-6M-H8

CE

## Applications

- Shipbuilding
- Machinery
- Structural fabrication

## Features

- Good weldability in thin plate and root pass welding
- High productivity and automatic applications
- Minimum amount of slag & spatter
- Use 100% CO<sub>2</sub> gas or Ar-CO<sub>2</sub> mixture (Dual gas)
- All position welding
- Good anti-porosity

## Welding Position



1G 2F 3G 4G  
(PA) (PB) (PF-PG) (PE)

## Current

DC +

## Shielding Gas

100% CO<sub>2</sub>  
Ar + 20~25% CO<sub>2</sub>

## Diameter / Packaging

Diameter	Spool			Pac		
	5kg (11lbs)	15kg (33 lbs)	20kg (44lbs)	250kg (551lbs)	300kg (661lbs)	350kg (771lbs)
1.0 (0.040)	✓	✓	✓	✓	✓	✓
1.2 (0.045)	✓	✓	✓	✓	✓	✓

Typical Chemical Composition of All-Weld Metal (%)

	C	Si	Mn	P	S
100% CO <sub>2</sub>	0.06	0.60	1.20	0.011	0.014
80% Ar + 20% CO <sub>2</sub>	0.07	0.65	1.45	0.010	0.011

Typical Mechanical Properties of All-Weld Metal

	YS MPa(lbs/in <sup>2</sup> )	TS MPa(lbs/in <sup>2</sup> )	EL (%)	Temp °C(°F)	CVN-Impact Value J (ft-lbs)
100% CO <sub>2</sub>	520 (75,500)	590 (85,700)	27	-20 (-4)	45 (33)
80% Ar + 20% CO <sub>2</sub>	550 ( 79,900)	620 (90,000)	27	-30 (-22)	50 (37)

Typical Operating Procedures

Diameter, Polarity Shielding Gas	CTWD mm (in)	Wire Feed Speed m/min (in/min)	Voltage (volts)	Approx. Current (amps)	Deposition Rate kg/hr (lb/hr)	Efficiency (%)
<b>1.2mm (0.045 in) DC+</b>						
100% CO <sub>2</sub>	19-25 (3/4-1)	<b>All Position</b>				
		3.4 (130)	13 - 18	80~120	1.8 (3.5)	90~92
		3.9 (148)	18 - 23	120~150	2.0 (4.2)	91~93
		<b>Flat &amp; Horizontal</b>				
		4.3 (171)	18~21	160~190	2.3 (4.8)	91~93
		7.8 (320)	25~28	230~250	3.9 (8.3)	92~94
10.9 (390)	30~32	270~300	5.0 (11.1)	94~96		

SWAW

SAW

GMAW

GTAW

FCAW

Non-FERROUS

APPENDIX

# SC-70Z Cored

Type : Metal-Cored

## Conformances

AWS A5.36M/ ASME SFA5.36M E490T15-C1A0-G  
E490T15-M21A0-G  
EN ISO 17632-A-T 46 Z M M/C 3

CWB CSA W48 E491T-G

## Applications

- Automotive
- Galvanized steel structure
- Shipbuilding

## Features

- Designed for low carbon and low alloy galvanized steel sheet
- Applicable to the zinc plate steel
- Low spatter
- Good anti-porosity

## Welding Position



1G 2F 3G  
(PA) (PB) (PF-PG)

## Current

DC +

## Shielding Gas

Ar + 20~25% CO<sub>2</sub>

## Diameter / Packaging

Diameter	Spool			Pac		
	5kg (11lbs)	15kg (33 lbs)	20kg (44lbs)	250kg (551lbs)	300kg (661lbs)	350kg (771lbs)
1.0 (0.040)	✓	✓	✓	✓	✓	✓
1.2 (0.045)	✓	✓	✓	✓	✓	✓



**Typical Chemical Composition of All-Weld Metal (%)**

C	Si	Mn	P	S
0.10	0.61	1.57	0.025	0.014

**Typical Mechanical Properties of All-Weld Metal**

YS MPa(lbs/in <sup>2</sup> )	TS MPa(lbs/in <sup>2</sup> )	EL (%)	Temp °C(°F)	CVN-Impact Value J (ft.-lbs)
580 (84,200)	640 (92,900)	25	0 (32)	105 (77)

**Typical Operating Procedures**

Diameter, Polarity Shielding Gas	CTWD mm (in)	Wire Feed Speed m/min (in/min)	Voltage (volts)	Approx. Current (amps)	Deposition Rate kg/hr (lb/hr)	Efficiency (%)
<b>1.2mm (0.045 in) DC+</b>						
<b>All Position</b>						
80% Ar + 20% CO <sub>2</sub>	19-25 (3/4-1)	4.9 (187)	23~25	140~160	2.3 (4.9)	93~94
		6.3 (243)	24~26	190~210	2.9 (6.3)	94~96
		<b>Flat &amp; Horizontal</b>				
		9.5 (368)	29~31	280~300	2.5 (9.2)	94~96

SWAW

SAW

GMAW

GTAW

FCAW

Non-FERROUS

APPENDIX

# Supercored 70NS

Type : Metal-Cored



## Conformances

AWS A5.36/ ASME SFA5.36 E70T15-M21A2-CS1  
 JIS Z3313 T49 3 T15-0 M A H5  
 EN ISO 17632-A-T T 42 3 M M 3 H5  
 ABS 3SAH5, 3YSA  
 LR 3S, 3YSH5  
 BV SA3M, SA3YM HHH  
 DNV IIIYMS H5

GL 3YH5S  
 TÜV EN ISO 17632-A-T 423MM3  
 CWB CSA W48 E492C-6M-H4  
 CE  
 DB DIN EN ISO 17632-A-T 422MM3  
 RINA 3YS H5

## Applications

- Machinery
- Structural fabrication
- Automotive or robotic welding.
- Shipbuilding

## Features

- Designed for welding with Ar + CO<sub>2</sub> shielding gas
- High deposition rates, stable arc, travel speed
- Low spatter
- Good anti-porosity

## Welding Position



1G 2F 3G  
 (PA) (PB) (PF-PG)

## Current

DC +

## Shielding Gas

Ar + CO<sub>2</sub>

## Diameter / Packaging

Diameter mm (in)	Spool			Pac		
	5kg (11lbs)	15kg (33lbs)	20kg (44lbs)	250kg (551lbs)	300kg (661lbs)	350kg (771lbs)
1.2 (0.045)	✓	✓	✓	✓	✓	✓
1.4 (0.052)	✓	✓	✓	✓	✓	✓
1.6 (1/16)	✓	✓	✓	✓	✓	✓

**Typical Chemical Composition of All-Weld Metal (%)**

	C	Si	Mn	P	S
80% Ar + 20% CO <sub>2</sub>	0.038	0.66	1.63	0.012	0.005
90% Ar + 10% CO <sub>2</sub>	0.036	0.69	1.67	0.012	0.005

**Typical Mechanical Properties of All-Weld Metal**

	YS MPa(lbs/in <sup>2</sup> )	TS MPa(lbs/in <sup>2</sup> )	EL (%)	Temp °C(°F)	CVN-Impact Value J (ft-lbs)
80% Ar + 20% CO <sub>2</sub>	481 (69,700)	566 (82,000)	24.4	-30 (-22)	50 (37)
90% Ar + 10% CO <sub>2</sub>	492 (71,340)	564 (81,700)	24.4	-30 (-22)	49 (36)

**Typical Operating Procedures**

Diameter, Polarity Shielding Gas	CTWD mm (in)	Wire Feed Speed m/min (in/min)	Voltage (volts)	Approx. Current (amps)	Deposition Rate kg/hr (lb/hr)	Efficiency (%)
<b>1.2mm (0.045 in) DC+</b>						
<b>Flat &amp; Horizontal</b>						
90% Ar + 10% CO <sub>2</sub>	19-25 (3/4-1)	7.3 (288)	22 - 26	190-210	3.4 (7.6)	90-96
		9.7 (382)	23 - 27	240-260	4.5 (9.7)	
		12.2 (489)	24 - 30	280-310	5.9 (12.8)	
<b>1.4mm (0.052 in) DC+</b>						
<b>Flat &amp; Horizontal</b>						
90% Ar + 10% CO <sub>2</sub>	19-25 (3/4-1)	6.7 (261)	22 - 26	250-270	3.8 (8.3)	92-96
		7.8 (307)	25 - 31	290-310	4.9 (10.4)	
		9.4 (370)	28 - 32	330-350	5.5 (12.0)	
<b>1.6mm (1/16 in) DC+</b>						
<b>Flat &amp; Horizontal</b>						
90% Ar + 10% CO <sub>2</sub>	25-32 (1-1 1/4)	5.6 (220)	26 - 32	290-310	4.5 (9.3)	93-96
		6.8 (270)	29 - 33	340-350	5.6 (12.1)	
		7.8 (310)	31 - 34	350-370	6.7 (14.3)	

SWAW

SAW

GMAW

GTAW

FCAW

Non-FERROUS

APPENDIX

# Supercored 70B

Type : Basic



## Conformances

AWS A5.36/ ASME SFA5.36 E71T5-M21A4-CS1 H4  
JIS Z3313 T49 4 T5-1 M A-U H5  
EN ISO 17632-A-T42 4 B M 3 H5  
ABS 3YSAH5  
LR 3S, 3YSH5  
BV SA3YM HHH

DNV IIIYMS H5  
GL 3YH5S  
TÜV EN ISO 17632-A-T42 4 B M 3 H5  
DB EN ISO 17632-A-T42 4 B M 3 H5  
CE

## Applications

- Shipbuilding
- Structural fabrication

## Features

- Good crack resistance
- Good impact value at low temperature
- Good anti-porosity

## Welding Position



1G 2F 3G  
(PA) (PB) (PF-PG)

## Current

DC +

## Shielding Gas

Ar + 20~25% CO<sub>2</sub>

## Diameter / Packaging

Diameter mm (in)	Spool			Pac		
	5kg (11lbs)	15kg (33lbs)	20kg (44lbs)	100kg (221lbs)	200kg (441lbs)	250kg (551lbs)
1.0 (0.040)	✓	✓	✓			
1.2 (0.045)	✓	✓	✓			
1.4 (0.052)	✓	✓	✓			
1.6 (1/16)	✓	✓	✓			

Typical Chemical Composition of All-Weld Metal (%)

C	Si	Mn	P	S
0.06	0.43	1.33	0.011	0.013

Typical Mechanical Properties of All-Weld Metal

YS MPa(lbs/in <sup>2</sup> )	TS MPa(lbs/in <sup>2</sup> )	EL (%)	Temp °C(°F)	CVN-Impact Value J (ft.-lbs)
450 (65,300)	520 (75,400)	32.0	-40 (-40)	78 (58)

Typical Operating Procedures

Diameter, Polarity Shielding Gas	CTWD mm (in)	Wire Feed Speed m/min (in/min)	Voltage (volts)	Approx. Current (amps)	Deposition Rate kg/hr (lb/hr)	Efficiency (%)
<b>1.2mm (0.045 in) DC+</b>						
80% Ar + 20% CO <sub>2</sub>	25 (1)	4.5 (175)	17~22	120~160	1.5 (3.3)	86~88
		6.4 (250)	18~24	135~175	2.2 (4.8)	
		7.6 (300)	19~25	150~180	2.5 (5.5)	
		8.9 (350)	22~27	175~205	3.0 (6.6)	
		10.2 (400)	24~29	185~220	3.5 (7.6)	
		11.5 (450)	25~30	220~260	3.8 (8.4)	
		12.8 (500)	26~31	250~290	4.4 (9.6)	
15.3 (600)	27~32	280~320	5.3 (11.6)			
<b>1.4mm (0.052 in) DC+</b>						
80% Ar + 20% CO <sub>2</sub>	25 (1)	3.8 (150)	19~24	130~170	1.9 (4.1)	86~89
		5.1 (200)	20~25	160~200	2.5 (5.5)	
		6.4 (250)	21~27	180~230	3.0 (6.6)	
		7.6 (300)	22~28	220~260	4.2 (9.2)	
		10.2 (400)	26~31	270~320	5.5 (12.1)	
		12.8 (500)	27~33	300~350	6.0 (13.2)	
<b>1.6mm (1/16 in) DC+</b>						
80% Ar + 20% CO <sub>2</sub>	25 (1)	3.2 (125)	21~24	170~210	2.0 (4.4)	86~89
		3.8 (150)	22~25	180~220	2.5 (5.5)	
		5.1 (200)	24~28	220~260	3.2 (7.0)	
		6.4 (250)	25~31	270~320	4.0 (8.8)	
		7.6 (300)	27~33	300~350	5.0 (11.0)	
		10.2 (400)	33~37	350~400	6.4 (14.0)	

SMW

SAW

GMAW

GTAW

FCAW

Non-FERROUS

APPENDIX

# Supercored 70SB

Type : Basic

## Conformances

AWS A5.36/ ASME SFA5.36 E71T5-C1A2-CS1 H4

JIS Z3313 T49 4 T5-1 M A-U H5

EN ISO 17632-A-T 42 3 B C 2 H5

KR 3YSG(C1)H5

ABS 3SA, 3YSAH5

LR 3YSH5

BV SA3YM HHH

DNV IIIYMS H5

GL 3YH5S

NK KSW53G(C)H5

## Applications

- Shipbuilding
- Structural fabrication
- Heavy equipment

## Features

- Good crack resistance
- Good impact value at low temperature

## Welding Position



1G (PA) 2F (PB) 3G (PF-PG) 1G (PA)  
DC + DC (-)

## Current

DC ±

## Shielding Gas

100% CO<sub>2</sub>

## Diameter / Packaging

Diameter	Spool			Pac			
	mm (in)	12.5kg (28lbs)	15kg (33lbs)	20kg (44lbs)	250kg (551lbs)	300kg (661lbs)	350kg (771lbs)
0.8 (0.033)							
0.9 (0.035)							
1.0 (0.040)							
1.2 (0.045)	✓	✓	✓				
1.4 (0.052)	✓	✓	✓				
1.6 (1/16)	✓	✓	✓				

## Typical Chemical Composition of All-Weld Metal (%)

C	Si	Mn	P	S
0.07	0.5	0.4	0.008	0.010

## Typical Mechanical Properties of All-Weld Metal

YS MPa(lbs/in <sup>2</sup> )	TS MPa(lbs/in <sup>2</sup> )	EL (%)	Temp °C(°F)	CVN-Impact Value J (ft-lbs)	Polarity
570 (82,800)	620 (90,000)	26	-30 (-22)	70 (52)	DC (-)
500 (72,600)	550 (79,900)	31	-30 (-22)	80 (59)	DC (+)

## Typical Operating Procedures

Diameter, Polarity Shielding Gas	CTWD mm (in)	Wire Feed Speed m/min (in/min)	Voltage (volts)	Approx. Current (amps)	Deposition Rate kg/hr (lb/hr)	Efficiency (%)
<b>1.2mm (0.045 in) DC+</b>						
100% CO <sub>2</sub>	25 (1)	4.5 (175)	18~23	120~160	1.5 (3.3)	86~88
		6.4 (250)	19~25	135~175	2.2 (4.8)	
		7.6 (300)	20~26	150~180	2.5 (5.5)	
		8.9 (350)	23~28	175~205	3.0 (6.6)	
		10.2 (400)	25~30	185~220	3.5 (7.6)	
		11.5 (450)	26~31	220~260	3.8 (8.4)	
		12.8 (500)	27~32	250~290	4.4 (9.6)	
15.3 (600)	28~33	280~320	5.3 (11.6)			
<b>1.4mm (0.052 in) DC+</b>						
100% CO <sub>2</sub>	25 (1)	3.8 (150)	20~25	130~170	1.9 (4.1)	85~89
		5.1 (200)	21~26	160~200	2.5 (5.5)	
		6.4 (250)	22~28	180~230	3.0 (6.6)	
		7.6 (300)	23~29	220~260	4.2 (9.2)	
		10.2 (400)	27~32	270~320	5.5 (12.1)	
		12.8 (500)	28~34	300~350	6.0 (13.2)	
<b>1.6mm (1/16 in) DC+</b>						
100% CO <sub>2</sub>	25 (1)	3.2 (125)	22~25	170~210	2.0 (4.4)	84~87
		3.8 (150)	23~26	180~220	2.5 (5.5)	
		5.1 (200)	25~29	220~260	3.2 (7.0)	
		6.4 (250)	26~32	270~320	4.0 (8.8)	
		7.6 (300)	28~34	300~350	5.0 (11.0)	
		10.2 (400)	34~38	350~400	6.4 (14.0)	

# SC-EG2 Cored

Type : Metal-Cored

## Conformances

AWS A5.26/ ASME SFA5.26 EG70T-2C  
 JIS Z3319 YFEG-22C  
 KR 3V, 3YV  
 ABS 3, 3YH10  
 LR 3, 3Y  
 BV AV3, AV3Y  
 DNV ILY (-20°C)  
 GL 3YV  
 NK KEW53  
 CCS 3, 3Y  
 RINA 3Y

## Applications

- Shipbuilding
- Storage tank

## Features

- Electro gas arc welding process
- Hig deposition (Vertical up butt welding)

## Welding Position



3G  
(PF)

## Current

DC +

## Shielding Gas

100% CO<sub>2</sub>

## Diameter / Packaging

Diameter	Spool	
	15kg (33lbs)	20kg (44lbs)
mm (in)		
1.6 (1/16)	✓	✓

## Typical Chemical Composition of All-Weld Metal (%)

C	Si	Mn	P	S	Mo
0.08	0.3	1.52	0.012	0.010	0.12

## Typical Mechanical Properties of All-Weld Metal

YS MPa(lbs/in <sup>2</sup> )	TS MPa(lbs/in <sup>2</sup> )	EL (%)	Temp °C(°F)	CVN-Impact Value J (ft.lbs)
510 (74,000)	560 (81,300)	27	-20 (0)	60 (44)

## Typical Operating Procedures

Diameter, Polarity Shielding Gas	CTWD mm (in)	Wire Feed Speed m/min (in/min)	Voltage (volts)	Approx. Current (amps)	Deposition Rate kg/hr (lb/hr)	Efficiency (%)
<b>1.6mm (1/16 in) DC+</b>						
100% CO <sub>2</sub>	25 (1)	8.3 (327)	32	330	5.8 (12.8)	92-94
		8.8 (346)	34	350	6.6 (14.6)	92-94
		9.8 (386)	38	380	7.1 (15.7)	93-95



# SC-EG3

Type : Metal-Cored

## Conformances

AWS	A5.26/ ASME SFA5.26 EG82T-NM2
KR	4Y40VH5
ABS	5Y400 H5
LR	4Y40 H5
BV	AV5Y40 HHH
DNV	VY40(H5)
GL	6Y40H5V
NK	KEW54Y40G(C)H5 (-60°C ≥39J)

## Applications

- Shipbuilding
- LPG and LNG storage tank

## Features

- Electro gas arc welding process
- High deposition(vertical up butt welding)
- Low temperature service

## Welding Position



3G  
(PF)

## Current

DC +

## Shielding Gas

100% CO<sub>2</sub>

## Diameter / Packaging

Diameter	Spool
mm (in)	20kg (44lbs)
1.6 (1/16)	✓

## Typical Chemical Composition of All-Weld Metal (%)

C	Si	Mn	P	S	Ni
0.07	0.22	1.52	0.012	0.010	1.8

## Typical Mechanical Properties of All-Weld Metal

YS MPa(lbs/in <sup>2</sup> )	TS MPa(lbs/in <sup>2</sup> )	EL (%)	Temp °C(°F)	CVN-Impact Value J (ft.-lbs)
575 (83,400)	672 (94,500)	23.5	-60 (76)	50 (37)

## Typical Operating Procedures

Diameter, Polarity Shielding Gas	CTWD mm (in)	Wire Feed Speed m/min (in/min)	Voltage (volts)	Approx. Current (amps)	Deposition Rate kg/hr (lb/hr)	Efficiency (%)
1.6mm (1/16 in) DC+						
100% CO <sub>2</sub>	25 (1)	8.2 (323)	32	330	5.5 (12.1)	91-93
		8.6 (346)	34	350	6.2 (14.6)	91-93
		9.6 (378)	38	380	6.8 (15.0)	92-94

SMW

SAW

GMW

GTAW

FCW

Non-FERROUS

APPENDIX

# SC-55 Cored

Type : Rutile

## Conformances

AWS A5.36/ ASME SFA5.36 E81T1-C1A0-G

JIS Z3313 T55 2 T1-1 C A-U H10

## Applications

- Structural fabrication
- Storage tank
- Bridge construction
- Steel industry

## Features

- Designed for welding with 100% CO<sub>2</sub> shielding gas
- Good crack resistance
- Smooth and stable arc with a fast freezing slag
- All position welding

## Welding Position



1G 2F 3G 4G  
(PA) (PB) (PF-PG) (PE)

## Current

DC +

## Shielding Gas

100% CO<sub>2</sub>

## Diameter / Packaging

Diameter	Spool			Pac		
	5kg (11lbs)	15kg (33lbs)	20kg (44lbs)	100kg (221lbs)	200kg (441lbs)	250kg (551lbs)
1.2 (0.045)	✓	✓	✓	✓	✓	✓
1.4 (0.052)	✓	✓	✓	✓	✓	✓
1.6 (1/16)	✓	✓	✓	✓	✓	✓

Typical Chemical Composition of All-Weld Metal (%)

C	Si	Mn	P	S
0.06	0.45	1.40	0.012	0.006

Typical Mechanical Properties of All-Weld Metal

YS MPa(lbs/in <sup>2</sup> )	TS MPa(lbs/in <sup>2</sup> )	EL (%)	Temp °C(°F)	CVN-Impact Value J (ft.-lbs)
560 (81,200)	610 (88,500)	28.5	-20 (-4)	80 (59)

Typical Operating Procedures

Diameter, Polarity Shielding Gas	CTWD mm (in)	Wire Feed Speed m/min (in/min)	Voltage (volts)	Approx. Current (amps)	Deposition Rate kg/hr (lb/hr)	Efficiency (%)
<b>1.2mm (0.045 in) DC+</b>						
100% CO <sub>2</sub>	25 (1)	4.5 (175)	18~23	120~160	1.5 (3.3)	86~88
		6.4 (250)	19~25	135~175	2.2 (4.8)	
		7.6 (300)	20~26	150~180	2.5 (5.5)	
		8.9 (350)	23~28	175~205	3.0 (6.6)	
		10.2 (400)	25~30	185~220	3.5 (7.6)	
		11.5 (450)	26~31	220~260	3.9 (8.6)	
		12.8 (500)	27~32	250~290	4.3 (9.5)	
15.3 (600)	28~33	280~320	5.2 (11.4)			
<b>1.4mm (0.052 in) DC+</b>						
100% CO <sub>2</sub>	25 (1)	3.8 (150)	20~25	130~170	1.9 (4.1)	85~88
		5.1 (200)	21~26	160~200	2.5 (5.5)	
		6.4 (250)	22~28	180~230	3.0 (6.6)	
		7.6 (300)	23~29	220~260	4.2 (9.2)	
		10.2 (400)	24~30	270~320	5.4 (11.9)	
		12.8 (500)	25~31	300~350	6.0 (13.2)	
<b>1.6mm (1/16 in) DC+</b>						
100% CO <sub>2</sub>	25 (1)	3.2 (125)	22~25	170~210	2.0 (4.4)	84~87
		3.8 (150)	23~26	180~220	2.5 (5.5)	
		5.1 (200)	25~29	220~260	3.1 (6.8)	
		6.4 (250)	26~32	270~320	4.0 (8.8)	
		7.6 (300)	28~34	300~350	5.0 (11.0)	
		10.2 (400)	34~38	350~400	6.4 (14.0)	

SMW

SAW

GMAW

GTAW

FCAW

Non-FERROUS

APPENDIX

# SC-55F Cored

Type : Semi-Metal

## Conformances

AWS A5.36/ ASME SFA5.36 E80T1-C1A0-G

JIS Z3313 T55 2 T15-0 C A-N1-U H10

## Applications

- Structural fabrication
- Storage tank
- Bridge construction
- Steel industry

## Features

- Minimum spatter level
- Easy to remove slag
- Good anti-porosity

## Welding Position



1G 2F  
(PA) (PB)

## Current

DC +

## Shielding Gas

100% CO<sub>2</sub>

## Diameter / Packaging

Diameter	Spool			Pac		
	5kg (11lbs)	15kg (33lbs)	20kg (44lbs)	100kg (221lbs)	250kg (551lbs)	300kg (661lbs)
1.2 (0.045)	✓	✓		✓	✓	✓
1.4 (0.052)	✓	✓		✓	✓	✓
1.6 (1/16)	✓	✓		✓	✓	✓

Typical Chemical Composition of All-Weld Metal (%)

C	Si	Mn	P	S
0.05	0.48	1.56	0.012	0.010

Typical Mechanical Properties of All-Weld Metal

YS MPa(lbs/in <sup>2</sup> )	TS MPa(lbs/in <sup>2</sup> )	EL (%)	Temp °C(°F)	CVN-Impact Value J (ft.-lbs)
580 (84,200)	625 (90,600)	24.5	-20 (-4)	60 (44)

Typical Operating Procedures

Diameter, Polarity Shielding Gas	CTWD mm (in)	Wire Feed Speed m/min (in/min)	Voltage (volts)	Approx. Current (amps)	Deposition Rate kg/hr (lb/hr)	Efficiency (%)
<b>1.2mm (0.045 in) DC+</b>						
100% CO <sub>2</sub>	20~25 (51/64~1)	11.5 (450)	26	225	4.1 (9.0)	85~86
		12.5 (480)	29	245	4.4 (9.7)	87~88
		14.2 (560)	30	265	4.9 (10.8)	87~89
		15.2 (610)	31	285	5.4 (11.9)	89~90
<b>1.4mm (0.052 in) DC+</b>						
100% CO <sub>2</sub>	20~25 (51/64~1)	9.6 (380)	26	255	4.4 (9.8)	87~88
		10.6 (420)	27	275	5.0 (11.0)	87~88
		12.1 (480)	31	295	5.5 (12.1)	88~89
		12.7 (500)	32	325	5.8 (12.8)	88~90
		13.1 (515)	32	350	6.1 (13.4)	88~90
<b>1.6mm (1/16 in) DC+</b>						
100% CO <sub>2</sub>	20~25 (51/64~1)	6.4 (250)	28	270	3.8 (8.5)	86~88
		7.3 (290)	32	295	4.6 (10.1)	87~89
		8.6 (340)	32	335	5.6 (12.3)	87~89
		10.0 (390)	35	360	6.4 (14.1)	89~91

SWAW

SAW

GMAW

GTAW

FCAW

Non-FERROUS

APPENDIX

# Supercored 81

Type : Rutile

## Conformances

AWS A5.36/ ASME SFA5.36 E81T1-C1A2-Ni1

JIS Z3313 T55 3 T1-1 C A-N2-U H10

EN ISO 17632-A-T 46 2 1Ni P C 1

## Applications

- Machinery
- Structural fabrication
- Storage tank
- Bridge construction

## Features

- Good arc performance and low spatter
- Easy to remove slag
- Good impact value

## Welding Position



1G 2F 3G 4G  
(PA) (PB) (PF) (PE)

## Current

DC +

## Shielding Gas

100% CO<sub>2</sub>

## Diameter / Packaging

Diameter	Spool			Pac		
	5kg (11lbs)	15kg (33lbs)	20kg (44lbs)	100kg (221lbs)	200kg (441lbs)	250kg (551lbs)
1.0 (0.040)						
1.2 (0.045)		√	√		√	√
1.4 (0.052)		√	√		√	√
1.6 (1/16)		√	√		√	√

## Typical Chemical Composition of All-Weld Metal (%)

C	Si	Mn	P	S	Ni
0.03	0.35	1.25	0.011	0.012	0.95

## Typical Mechanical Properties of All-Weld Metal

YS MPa(lbs/in <sup>2</sup> )	TS MPa(lbs/in <sup>2</sup> )	EL (%)	Temp °C(°F)	CVN-Impact Value J (ft.-lbs)
570 (82,700)	640 (92,900)	25	-30 (-22)	90 (66)

## Typical Operating Procedures

Diameter, Polarity Shielding Gas	CTWD mm (in)	Wire Feed Speed m/min (in/min)	Voltage (volts)	Approx. Current (amps)	Deposition Rate kg/hr (lb/hr)	Efficiency (%)
<b>1.2mm (0.045 in) DC+</b>						
100% CO <sub>2</sub>	25 (1)	4.5 (175)	18~23	120~160	1.5 (3.3)	86~88
		6.4 (250)	19~25	135~175	2.2 (4.8)	
		7.6 (300)	20~26	150~180	2.5 (5.5)	
		8.9 (350)	23~28	175~205	3.0 (6.6)	
		10.2 (400)	25~30	185~220	3.5 (7.6)	
		11.5 (450)	26~31	220~260	3.8 (8.4)	
		12.8 (500)	27~32	250~290	4.4 (9.6)	
15.3 (600)	28~33	280~320	5.3 (11.6)			
<b>1.4mm (0.052 in) DC+</b>						
100% CO <sub>2</sub>	25 (1)	3.8 (150)	20~25	130~170	1.9 (4.1)	85~88
		5.1 (200)	21~26	160~200	2.5 (5.5)	
		6.4 (250)	22~28	180~230	3.0 (6.6)	
		7.6 (300)	23~29	220~260	4.2 (9.2)	
		10.2 (400)	27~32	270~320	5.5 (12.1)	
		12.8 (500)	28~34	300~350	6.0 (13.2)	
<b>1.6mm (1/16 in) DC+</b>						
100% CO <sub>2</sub>	25 (1)	3.2 (125)	22~25	170~210	2.0 (4.4)	84~87
		3.8 (150)	23~26	180~220	2.5 (5.5)	
		5.1 (200)	25~29	220~260	3.2 (7.0)	
		6.4 (250)	26~32	270~320	4.0 (8.8)	
		7.6 (300)	28~34	300~350	5.0 (11.0)	
		10.2 (400)	34~38	350~400	6.4 (14.0)	

# SF-80MX

Type : Semi-Metal

## Conformances

AWS A5.36/ ASME SFA5.36 E80T1-C1A2-G

JIS Z3313 T55 2 T15-0 C A-N2 H10

EN ISO 17632-A-T 46 2 1Ni R C 3

## Applications

- Structural fabrication
- High tensile steel(590MPa steel class)
- Steel industry

## Features

- Good deposition rate
- Good penetration and good arc stability

## Welding Position



1G 2F  
(PA) (PB)

## Current

DC +

## Shielding Gas

100% CO<sub>2</sub>

## Diameter / Packaging

Diameter mm (in)	Spool			Pac		
	5kg (11lbs)	15kg (33lbs)	20kg (44lbs)	100kg (221lbs)	250kg (551lbs)	300kg (661lbs)
1.2 (0.045)	✓	✓		✓	✓	✓
1.4 (0.052)	✓	✓		✓	✓	✓
1.6 (1/16)	✓	✓		✓	✓	✓



### Typical Chemical Composition of All-Weld Metal (%)

C	Si	Mn	P	S	Ni
0.06	0.55	1.42	0.015	0.010	1.00

### Typical Mechanical Properties of All-Weld Metal

YS MPa(lbs/in <sup>2</sup> )	TS MPa(lbs/in <sup>2</sup> )	EL (%)	Temp °C(°F)	CVN-Impact Value J (ft.-lbs)
590 (85,600)	630 (91,400)	24	-20 (-4)	53 (39)

### Typical Operating Procedures

Diameter, Polarity Shielding Gas	CTWD mm (in)	Wire Feed Speed m/min (in/min)	Voltage (volts)	Approx. Current (amps)	Deposition Rate kg/hr (lb/hr)	Efficiency (%)
<b>1.2mm (0.045 in) DC+</b>						
100% CO <sub>2</sub>	20~25 (51/64~1)	11.5 (450)	26	225	4.1 (9.0)	85~86
		12.5 (480)	29	245	4.4 (9.7)	87~88
		14.2 (560)	30	265	4.9 (10.8)	87~89
		15.2 (610)	31	285	5.4 (11.9)	89~90
<b>1.4mm (0.052 in) DC+</b>						
100% CO <sub>2</sub>	20~25 (51/64~1)	9.6 (380)	26	255	4.4 (9.8)	87~88
		10.6 (420)	27	275	5.0 (11.0)	87~88
		12.1 (480)	31	295	5.5 (12.1)	88~89
		12.7 (500)	32	325	5.8 (12.8)	88~90
		13.1 (515)	32	350	6.1 (13.4)	88~90
<b>1.6mm (1/16 in) DC+</b>						
100% CO <sub>2</sub>	20~25 (51/64~1)	6.4 (250)	28	270	3.8 (8.5)	86~88
		7.3 (290)	32	295	4.6 (10.1)	87~89
		8.6 (340)	32	335	5.6 (12.3)	87~89
		10.0 (390)	35	360	6.4 (14.1)	89~91

# SC-80M

Type : Metal-Cored

## Conformances

AWS A5.36/ ASME SFA5.36 E80T15-M21A4-G

EN ISO 17632-A T 46 4 M M 3 H5

## Applications

- Bridge construction
- Structural fabrication
- Robotic welding
- Transportation equipment

## Features

- High strength weathering grade steels(Corten steel)
- Good anti-porosity

## Welding Position



1G 2F  
(PA) (PB)

## Current

DC +

## Shielding Gas

Ar + CO<sub>2</sub>

## Diameter / Packaging

Diameter mm (in)	Spool			Pac		
	5kg (11lbs)	15kg (33lbs)	20kg (44lbs)	250kg (551lbs)	300kg (661lbs)	350kg (771lbs)
1.2 (0.045)	✓	✓	✓	✓	✓	✓
1.4 (0.052)	✓	✓	✓	✓	✓	✓
1.6 (1/16)	✓	✓	✓	✓	✓	✓

**Typical Chemical Composition of All-Weld Metal (%)**

C	Si	Mn	P	S	Cr	Ni	Cu
0.07	0.63	1.65	0.014	0.010	0.25	0.72	0.34

**Typical Mechanical Properties of All-Weld Metal**

YS MPa(lbs/in <sup>2</sup> )	TS MPa(lbs/in <sup>2</sup> )	EL (%)	Temp °C(°F)	CVN-Impact Value J (ft.-lbs)
610 (88,400)	658 (96,300)	24.5	-40 (-46)	60 (44)

**Typical Operating Procedures**

Diameter, Polarity Shielding Gas	CTWD mm (in)	Wire Feed Speed m/min (in/min)	Voltage (volts)	Approx. Current (amps)	Deposition Rate kg/hr (lb/hr)	Efficiency (%)
<b>1.2mm (0.045 in) DC+</b>						
<b>Flat &amp; Horizontal</b>						
90% Ar + 10% CO <sub>2</sub>	19-25 (3/4-1)	7.8 (307)	22~26	240~260	3.5 (7.5)	90~96
		9.4 (374)	22~27	270~290	4.0 (9.2)	
		10.3 (405)	23~27	300~320	4.5 (10.8)	
<b>1.4mm (0.052 in) DC+</b>						
<b>Flat &amp; Horizontal</b>						
90% Ar + 10% CO <sub>2</sub>	19-25 (3/4-1)	7.2 (283)	24~28	280~300	4.1 (8.9)	94~98
		7.7 (303)	26~29	310~330	4.9 (10.8)	
		10.9 (410)	27~30	350~370	6.6 (14.2)	
<b>1.6mm (1/16 in) DC+</b>						
<b>Flat &amp; Horizontal</b>						
90% Ar + 10% CO <sub>2</sub>	19-25 (3/4-1)	7.3 (287)	24~28	340~360	5.5 (11.9)	93~96
		8.4 (330)	26~29	390~410	6.8 (14.8)	
		12.5 (492)	27~30	450~470	9.2 (20.5)	

SWAW

SAW

GMAW

GTAW

FCAW

Non-FERROUS

APPENDIX

# SC-90M

Type : Metal-Cored

## Conformances

AWS A5.36/ ASME SFA5.36 E90T15-M21A6-G

EN ISO 18276-A T 55 Z Z M M 1 H5

## Applications

- Structural fabrication
- Robotic welding

## Features

- Low temperature
- Low spatter
- Good anti-porosity

## Welding Position



1G 2F 3G 4G  
(PA) (PB) (PF-PG) (PE)

## Current

DC +

## Shielding Gas

Ar + CO<sub>2</sub>

## Diameter / Packaging

Diameter	Spool			Pac		
	5kg (11lbs)	15kg (33lbs)	20kg (44lbs)	250kg (551lbs)	300kg (661lbs)	350kg (771lbs)
1.2 (0.045)	✓	✓	✓	✓	✓	✓
1.4 (0.052)	✓	✓	✓	✓	✓	✓

**Typical Chemical Composition of All-Weld Metal (%)**

C	Si	Mn	P	S	Ni	Mo
0.07	0.54	1.35	0.012	0.010	1.17	0.18

**Typical Mechanical Properties of All-Weld Metal**

YS MPa(lbs/in <sup>2</sup> )	TS MPa(lbs/in <sup>2</sup> )	EL (%)	Temp °C(°F)	CVN-Impact Value J (ft.-lbs)
610 (88,450)	672 (97,400)	25.5	-50 (-58)	60 (44)

**Typical Operating Procedures**

Diameter, Polarity Shielding Gas	CTWD mm (in)	Wire Feed Speed m/min (in/min)	Voltage (volts)	Approx. Current (amps)	Deposition Rate kg/hr (lb/hr)	Efficiency (%)
<b>1.2mm (0.045 in) DC+</b>						
<b>Flat &amp; Horizontal</b>						
90% Ar + 10% CO <sub>2</sub>	19-25 (3/4-1)	9.8 (385)	25~27	240~260	3.9 (8.6)	90~96
		13.1 (515)	27~29	270~290	5.4 (11.6)	
		14.6 (574)	29~31	320~340	6.2 (14.2)	
<b>1.4mm (0.052 in) DC+</b>						
<b>Flat &amp; Horizontal</b>						
90% Ar + 10% CO <sub>2</sub>	19-25 (3/4-1)	9.7 (381)	26~28	280~300	5.2 (11.6)	92~97
		12.8 (503)	28~30	310~330	7.4 (15.9)	
		15.6 (614)	30~32	350~370	8.8 (19.2)	

SWAW

SAW

GMAW

GTAW

FCAW

Non-FERROUS

APPENDIX

# SC-91

Type : Rutile

## Conformances

AWS A5.36M/ ASME SFA5.36M E621T1-C1A0-G

JIS Z3313 T57 2 T1-1 C A-N1 H10

EN ISO 17632-A T50 2 1Ni P C 1

## Applications

- Structural fabrication
- Steel industry

## Features

- Smooth and stable arc with a fast freezing slag
- Pre-heat recommended to avoid cold crack
- High-tensile steel (HSB 600)

## Welding Position



1G 2F 3G 4G  
(PA) (PB) (PF) (PE)

## Current

DC +

## Shielding Gas

100% CO<sub>2</sub>

## Diameter / Packaging

Diameter	Spool			Pac		
	5kg (11lbs)	15kg (33lbs)	20kg (44lbs)	100kg (221lbs)	200kg (441lbs)	250kg (551lbs)
1.2 (0.045)	✓	✓	✓			
1.4 (0.052)	✓	✓	✓			
1.6 (1/16)	✓	✓	✓			

### Typical Chemical Composition of All-Weld Metal (%)

C	Si	Mn	P	S	Ni
0.06	0.55	1.20	0.013	0.013	0.85

### Typical Mechanical Properties of All-Weld Metal

YS MPa(lbs/in <sup>2</sup> )	TS MPa(lbs/in <sup>2</sup> )	EL (%)	Temp °C(°F)	CVN-Impact Value J (ft.-lbs)
645 (93,600)	660 (95,800)	24.0	0 (32) -20 (-4)	100 (74) 70 (52)

### Typical Operating Procedures

Diameter, Polarity Shielding Gas	CTWD mm (in)	Wire Feed Speed m/min (in/min)	Voltage (volts)	Approx. Current (amps)	Deposition Rate kg/hr (lb/hr)	Efficiency (%)	
<b>1.2mm (0.045 in) DC+</b>							
100% CO <sub>2</sub>	25 (1)	All Position					86-88
		4.4 (175)	23-28	110-140	1.6 (3.5)		
		5.1 (200)	24-29	120-150	1.8 (4.0)		
		6.4 (250)	25-30	130-160	2.3 (5.0)		
		7.6 (300)	25-30	160-190	2.7 (6.0)		
		8.9 (350)	26-31	170-200	3.2 (7.0)		
		9.5 (375)	26-31	190-220	3.4 (7.5)		
		10.8 (425)	27-32	210-240	3.8 (8.5)		
		Flat & Horizontal					
		12.1 (475)	28-33	230-260	4.9 (10.8)		
		12.7 (500)	29-34	240-270	5.2 (11.4)		
		<b>1.4mm (0.052 in) DC+</b>					
100% CO <sub>2</sub>	25 (1)	All Position					86-88
		3.8 (150)	23-28	120-150	1.8 (3.9)		
		4.7 (180)	24-29	130-160	2.2 (4.8)		
		5.7 (225)	24-29	160-190	2.7 (5.9)		
		6.4 (250)	25-30	180-210	2.9 (6.5)		
		6.9 (275)	25-30	200-230	3.2 (7.2)		
		7.6 (300)	26-31	220-250	3.5 (7.8)		
		Flat & Horizontal					
		8.5 (335)	26-31	240-270	4.0 (8.7)		
		9.5 (375)	27-32	260-290	4.4 (9.8)		
		10.2 (400)	27-34	280-310	4.7 (10.4)		
		<b>1.6mm (1/16 in) DC+</b>					
100% CO <sub>2</sub>	25 (1)	All Position					86-88
		3.8 (150)	24-29	170-200	2.5 (5.5)		
		4.4 (175)	24-30	180-210	2.9 (6.4)		
		5.1 (200)	25-30	200-230	3.3 (7.3)		
		5.7 (225)	25-31	230-260	3.7 (8.2)		
		6.4 (250)	26-31	250-280	4.2 (9.2)		
		6.9 (275)	26-32	270-300	4.6 (10.1)		
		Flat & Horizontal					
		8.3 (325)	27-32	300-330	5.4 (11.9)		
		8.9 (350)	28-34	330-360	5.8 (12.8)		

SMAW

SAW

GMAW

GTAW

FCAW

Non-FERROUS

APPENDIX

# SC-90

Type : Semi-Metal

## Conformances

AWS A5.36M/ ASME SFA5.36M E620T1-C1A0-G

JIS Z3313 T62 2 T15-0 C A- H10

EN ISO 17632-A-T50 2 R C 3 H10

## Applications

- Structural fabrication and automotive
- General fabrication
- High tensile steel (HSB 600)

## Features

- High speed single welding in flat and horizontal positions

## Welding Position



1G 2F  
(PA) (PB)

## Current

DC +

## Shielding Gas

100% CO<sub>2</sub>

## Diameter / Packaging

Diameter mm (in)	Spool			Pac		
	5kg (11lbs)	15kg (33lbs)	20kg (44lbs)	100kg (221lbs)	250kg (551lbs)	300kg (661lbs)
1.2 (0.045)	✓	✓		✓	✓	✓
1.4 (0.052)	✓	✓		✓	✓	✓
1.6 (1/16)	✓	✓		✓	✓	✓



**Typical Chemical Composition of All-Weld Metal (%)**

C	Si	Mn	P	S	Ni	Mo
0.08	0.55	1.75	0.014	0.014	0.32	0.12

**Typical Mechanical Properties of All-Weld Metal**

YS MPa(lbs/in <sup>2</sup> )	TS MPa(lbs/in <sup>2</sup> )	EL (%)	Temp °C(°F)	CVN-Impact Value J (ft.-lbs)
600 (87,100)	660 (95,800)	22.5	-20 (-4)	66 (44)

**Typical Operating Procedures**

Diameter, Polarity Shielding Gas	CTWD mm (in)	Wire Feed Speed m/min (in/min)	Voltage (volts)	Approx. Current (amps)	Deposition Rate kg/hr (lb/hr)	Efficiency (%)
<b>1.2mm (0.045 in) DC+</b>						
100% CO <sub>2</sub>	20-25 (51/64~1)	10.4 (410)	26	200	3.5 (7.7)	85-87
		12.7 (500)	30	250	4.7 (10.4)	87-89
		15.3 (600)	33	300	6.3 (13.9)	91-93
<b>1.4mm (0.052 in) DC+</b>						
100% CO <sub>2</sub>	20-25 (51/64~1)	12.0 (470)	31	300	5.6 (12.3)	90-92
		12.5 (490)	32	320	6.1 (13.4)	91-93
		13.3 (520)	36	350	6.7 (14.8)	91-93
<b>1.6mm (1/16 in) DC+</b>						
100% CO <sub>2</sub>	20-25 (51/64~1)	7.6 (300)	33	300	4.9 (10.8)	87-89
		8.9 (350)	36	350	5.5 (12.1)	90-91
		10.2 (400)	38	400	6.3 (13.9)	90-91

SWAW

SAW

GMAW

GTAW

FCAW

Non-FERROUS

APPENDIX

# SC-91LP

Type : Rutile

## Conformances

AWS A5.36/ ASME SFA5.36 E91T1-M21A4-G  
EN ISO 17632-A-T50 4 1Ni P M 1 H5

## Applications

- Pipe Line
- Structural fabrication

## Features

- Designed for welding with Ar + 20~25% CO<sub>2</sub> shielding gas
- Good bead appearance
- Good performance in all positions (Orbital welding)
- Good impact value at low temperature

## Welding Position



1G 2F 3G 4G  
(PA) (PB) (PF) (PE)

## Current

DC +

## Shielding Gas

Ar + 20~25% CO<sub>2</sub>

## Diameter / Packaging

Diameter	Spool		
	5kg (11lbs)	15kg (33lbs)	20kg (44lbs)
1.2 (0.045)	✓	✓	✓

## Typical Chemical Composition of All-Weld Metal (%)

C	Si	Mn	P	S	Ni
0.05	0.40	1.40	0.013	0.006	0.90

## Typical Mechanical Properties of All-Weld Metal

YS MPa(lbs/in <sup>2</sup> )	TS MPa(lbs/in <sup>2</sup> )	EL (%)	Temp °C(°F)	CVN-Impact Value J (ft-lbs)
650 (94,300)	690 (100,000)	24.5	-20 (-4)	80 (59)
			-40 (-40)	60 (44)

## Typical Operating Procedures

Diameter, Polarity Shielding Gas	CTWD mm (in)	Wire Feed Speed m/min (in/min)	Voltage (volts)	Approx. Current (amps)	Melt-off Rate kg/hr (lb/hr)
1.2mm (0.045 in) DC+					
Ar + 20~25% CO <sub>2</sub>	25 (1)	4.4~10.2 (175~400)	23~30	130~275	1.8~4.1 (4.0~9.0)

# SC-91P

Type : Rutile

## Conformances

AWS A5.36M/ ASME SFA5.36M E621T1-M21A0-G  
EN ISO 18276-A-T55 0 Z P M 1

## Applications

- Pipe Line
- Structural fabrication

## Features

- Designed for welding with Ar + 20~25% CO<sub>2</sub> shielding gas
- Good bead appearance
- Good performance in all positions (Orbital welding)

## Welding Position



1G 2F 3G 4G  
(PA) (PB) (PF) (PE)

## Current

DC +

## Shielding Gas

Ar + 20~25% CO<sub>2</sub>

## Diameter / Packaging

Diameter	Spool		
	5kg (11lbs)	15kg (33lbs)	20kg (44lbs)
mm (in)			
1.2 (0.045)	✓	✓	✓

## Typical Chemical Composition of All-Weld Metal (%)

C	Si	Mn	P	S	Ni	Mo
0.05	0.45	1.30	0.013	0.010	0.85	0.22

## Typical Mechanical Properties of All-Weld Metal

YS MPa(lbs/in <sup>2</sup> )	TS MPa(lbs/in <sup>2</sup> )	EL (%)	Temp °C(°F)	CVN-Impact Value J (ft-lbs)
640 (92,900)	680 (98,700)	26.0	0 (32)	80 (59)

## Typical Operating Procedures

Diameter, Polarity Shielding Gas	CTWD mm (in)	Wire Feed Speed m/min (in/min)	Voltage (volts)	Approx. Current (amps)	Melt-off Rate kg/hr (lb/hr)
1.2mm (0.045 in) DC+					
Ar + 20~25% CO <sub>2</sub>	25 (1)	4.4~10.2 (175~400)	23~30	130~275	1.8~4.1 (4.0~9.0)

SWAW

SAW

GMAW

GTAW

FCAW

Non-FERROUS

APPENDIX

# SC-91K2 Cored

Type : Rutile

## Conformances

AWS A5.36/ ASME SFA5.36 E81T1-C1A4-K2

JIS Z3313 T57 4 T1-1 C A-N3 H10

EN ISO 17632-A T50 4 1.5Ni P C 1

ABS AWS A5.29 E91T1-K2C  
(-40°C ≥50 J)

DNV IVY50MS H5

CWB CSA W48 E621 T1-K2C-H8

## Applications

- General fabrication
- Offshore structure
- High tensile welded structure

## Features

- Good impact value at low temperature

## Welding Position



1G 2F 3G 4G  
(PA) (PB) (PF) (PE)

## Current

DC +

## Shielding Gas

100% CO<sub>2</sub>

## Diameter / Packaging

Diameter mm (in)	Spool			Pac		
	12.5kg (28lbs)	15kg (33lbs)	20kg (44lbs)	100kg (221lbs)	200kg (441lbs)	250kg (551lbs)
1.2 (0.045)	✓	✓	✓			
1.4 (0.052)	✓	✓	✓			
1.6 (1/16)	✓	✓	✓			

Typical Chemical Composition of All-Weld Metal (%)

C	Si	Mn	P	S	Ni	Mo
0.04	0.35	1.25	0.013	0.012	1.55	0.09

Typical Mechanical Properties of All-Weld Metal

YS MPa(lbs/in <sup>2</sup> )	TS MPa(lbs/in <sup>2</sup> )	EL (%)	Temp °C(°F)	CVN-Impact Value J (ft.-lbs)
620 (90,000)	650 (94,500)	27.0	-20 (-4) -40 (-40)	110 (81) 60 (44)

Typical Operating Procedures

Diameter, Polarity Shielding Gas	CTWD mm (in)	Wire Feed Speed m/min (in/min)	Voltage (volts)	Approx. Current (amps)	Deposition Rate kg/hr (lb/hr)	Efficiency (%)
<b>1.2mm (0.045 in) DC+</b>						
100% CO <sub>2</sub>	25 (1)	All Position				86-88
		4.4 (175)	23-28	110-140	1.6 (3.5)	
		5.1 (200)	24-29	120-150	1.8 (4.0)	
		6.4 (250)	25-30	130-160	2.3 (5.0)	
		7.6 (300)	25-30	160-190	2.7 (6.0)	
		8.9 (350)	26-31	170-200	3.2 (7.0)	
		9.5 (375)	26-31	190-220	3.4 (7.5)	
		10.8 (425)	27-32	210-240	3.8 (8.5)	
		Flat & Horizontal				
		12.1 (475)	28-33	230-260	4.9 (10.8)	
12.7 (500)	29-34	240-270	5.2 (11.4)			
<b>1.4mm (0.052 in) DC+</b>						
100% CO <sub>2</sub>	25 (1)	All Position				86-88
		3.8 (150)	23-28	120-150	1.8 (3.9)	
		4.7 (180)	24-29	130-160	2.2 (4.8)	
		5.7 (225)	24-29	160-190	2.7 (5.9)	
		6.4 (250)	25-30	180-210	2.9 (6.5)	
		6.9 (275)	25-30	200-230	3.2 (7.2)	
		7.6 (300)	26-31	220-250	3.5 (7.8)	
		Flat & Horizontal				
		8.5 (335)	26-31	240-270	4.0 (8.7)	
		9.5 (375)	27-32	260-290	4.4 (9.8)	
10.2 (400)	27-34	280-310	4.7 (10.4)			
<b>1.6mm (1/16 in) DC+</b>						
100% CO <sub>2</sub>	25 (1)	All Position				86-88
		3.8 (150)	24-29	170-200	2.5 (5.5)	
		4.4 (175)	24-30	180-210	2.9 (6.4)	
		5.1 (200)	25-30	200-230	3.3 (7.3)	
		5.7 (225)	25-31	230-260	3.7 (8.2)	
		6.4 (250)	26-31	250-280	4.2 (9.2)	
		6.9 (275)	26-32	270-300	4.6 (10.1)	
		Flat & Horizontal				
		8.3 (325)	27-32	300-330	5.4 (11.9)	
		8.9 (350)	28-34	330-360	5.8 (12.8)	

SMAW  
 SAW  
 GMAW  
 GTAW  
 FCAW  
 Non-FERROUS  
 APPENDIX

# Supercored 110

Type : Rutile

## Conformances

AWS A5.36/ ASME SFA5.36 E111T1-C1A4-G H4

ABS AWS A5.29 E111T1-GC-H4 (IV-40°C ≥41J)

KR 3Y69S(C) H5

## Applications

- Offshore structure
- High tensile welded structure

## Features

- Good impact value at low temperature
- Pre-heat recommended

## Welding Position



1G 2F 3G 4G  
(PA) (PB) (PF-PG) (PE)

## Current

DC +

## Shielding Gas

100% CO<sub>2</sub>

## Diameter / Packaging

Diameter	Spool			Pac		
	12.5kg (28lbs)	15kg (33lbs)	20kg (44lbs)	100kg (221lbs)	200kg (441lbs)	250kg (551lbs)
mm (in)						
1.2 (0.045)	✓	✓	✓			

## Typical Chemical Composition of All-Weld Metal (%)

C	Si	Mn	P	S	Ni	Mo
0.06	0.35	1.55	0.016	0.007	2.20	0.50

## Typical Mechanical Properties of All-Weld Metal

YS MPa(lbs/in <sup>2</sup> )	TS MPa(lbs/in <sup>2</sup> )	EL (%)	Temp °C(°F)	CVN-Impact Value J (ft.-lbs)
780 (113,000)	830 (121,000)	19.9	-40 (-40)	60 (44)

## Typical Operating Procedures

Diameter, Polarity Shielding Gas	CTWD mm (in)	Wire Feed Speed m/min (in/min)	Voltage (volts)	Approx. Current (amps)	Deposition Rate kg/hr (lb/hr)	Efficiency (%)
<b>1.2mm (0.045 in) DC+</b>						
100% CO <sub>2</sub>	25 (1)	<b>All Position</b>				86-88
		4.4 (175)	23-28	140	1.6 (3.5)	
		5.1 (200)	24-29	150	1.8 (4.0)	
		6.4 (250)	25-30	165	2.3 (5.0)	
		7.6 (300)	25-30	190	2.7 (6.0)	
		8.9 (350)	26-31	205	3.2 (7.0)	
		9.5 (375)	26-31	225	3.4 (7.5)	
		10.8 (425)	27-32	245	3.8 (8.5)	
		<b>Flat &amp; Horizontal</b>				
		12.1 (475)	28-33	265	4.9 (10.8)	
12.7 (500)	29-34	275	5.2 (11.4)			

SWAW

SAW

GMAW

GTAW

FCAW

Non-FERROUS

APPENDIX

# SC-110M Cored

Type : Metal-Cored

## Conformances

AWS A5.36/ ASME SFA5.36 E110T15-M21A6-G

EN ISO 18276-A-T 69 4 Mn2NiMo M M 3

## Applications

- High tensile welded structure
- Shipbuilding
- Heavy equipment

## Features

- Good performance and low spatter
- Smooth and stable arc with a fast freezing slag
- Pre-heat recommended
- Good anti-porosity

## Welding Position



1G 2F  
(PA) (PB)

## Current

DC +

## Shielding Gas

Ar + 20~25% CO<sub>2</sub>

## Diameter / Packaging

Diameter	Spool			Pac		
	5kg (11lbs)	15kg (33lbs)	20kg (44lbs)	250kg (551lbs)	300kg (661lbs)	350kg (771lbs)
mm (in)	✓	✓	✓	✓	✓	✓
1.2 (0.045)	✓	✓	✓	✓	✓	✓



**Typical Chemical Composition of All-Weld Metal (%)**

C	Si	Mn	P	S	Cr	Ni	Mo
0.04	0.70	1.80	0.015	0.015	0.10	2.00	0.60

**Typical Mechanical Properties of All-Weld Metal**

YS MPa(lbs/in <sup>2</sup> )	TS MPa(lbs/in <sup>2</sup> )	EL (%)	Temp °C(°F)	CVN-Impact Value J (ft.-lbs)
760 (110,200)	820 (119,000)	20	-51 (-60)	45 (34)

**Typical Operating Procedures**

Diameter, Polarity Shielding Gas	CTWD mm (in)	Wire Feed Speed m/min (in/min)	Voltage (volts)	Approx. Current (amps)	Deposition Rate kg/hr (lb/hr)	Efficiency (%)
<b>1.2mm (0.045 in) DC+</b>						
80% Ar + 20% CO <sub>2</sub>	19-25 (3/4-1)	<b>Flat &amp; Horizontal</b>				
		9.5 (374)	26-29	230-250	3.9 (8.6)	90-96
		12.2 (480)	28-31	280-300	5.3 (11.6)	
14.8 (582)	30-33	320-340	6.5 (14.2)			

SWAW

SAW

GMAW

GTAW

FCAW

Non-FERROUS

APPENDIX

# SF-70W

Type : Rutile

## Conformances

AWS A5.36/ ASME SFA5.36 E71T1-C1A0-G(W)

JIS Z3320 YFA-50W

## Applications

- Bridge construction
- Civil construction

## Features

- Good weather proof

## Welding Position



1G (PA) 2F (PB) 3G (PF) 4G (PE)

## Current

DC +

## Shielding Gas

100% CO<sub>2</sub>

## Diameter / Packaging

Diameter	Spool			Pac		
	12.5kg (28lbs)	15kg (33lbs)	20kg (44lbs)	100kg (221lbs)	200kg (441lbs)	250kg (551lbs)
1.0 (0.040)						
1.2 (0.045)	✓	✓	✓			
1.4 (0.052)	✓	✓	✓			
1.6 (1/16)	✓	✓	✓			

### Typical Chemical Composition of All-Weld Metal (%)

C	Si	Mn	P	S	Cr	Ni	Cu
0.04	0.45	1.05	0.017	0.011	0.5	0.35	0.4

### Typical Mechanical Properties of All-Weld Metal

YS MPa(lbs/in <sup>2</sup> )	TS MPa(lbs/in <sup>2</sup> )	EL (%)	Temp °C(°F)	CVN-Impact Value J (ft.-lbs)
510 (74,000)	580 (84,200)	28	0 (32)	60 (44)

### Typical Operating Procedures

Diameter, Polarity Shielding Gas	CTWD mm (in)	Wire Feed Speed m/min (in/min)	Voltage (volts)	Approx. Current (amps)	Deposition Rate kg/hr (lb/hr)	Efficiency (%)
<b>1.2mm (0.045 in) DC+</b>						
100% CO <sub>2</sub>	25 (1)	4.5 (175)	18~23	120~160	1.6 (3.5)	86~88
		6.4 (250)	19~25	135~175	2.3 (5.1)	
		7.6 (300)	20~26	150~180	2.6 (5.7)	
		8.9 (350)	23~28	175~205	3.1 (6.8)	
		10.2 (400)	25~30	185~220	3.6 (7.9)	
		11.5 (450)	26~31	220~260	3.9 (8.6)	
		12.8 (500)	27~32	250~290	4.5 (9.8)	
15.3 (600)	28~33	280~320	5.3 (11.6)			
<b>1.4mm (0.052 in) DC+</b>						
100% CO <sub>2</sub>	25 (1)	3.8 (150)	20~25	130~170	2.0 (4.3)	86~88
		5.1 (200)	21~26	160~200	2.5 (5.5)	
		6.4 (250)	22~28	180~230	3.0 (6.6)	
		7.6 (300)	23~29	220~260	4.2 (9.2)	
		10.2 (400)	27~32	270~320	5.6 (12.3)	
		12.8 (500)	28~34	300~350	6.1 (13.4)	
<b>1.6mm (1/16 in) DC+</b>						
100% CO <sub>2</sub>	25 (1)	3.2 (125)	22~25	170~210	2.1 (4.6)	85~87
		3.8 (150)	23~26	180~220	2.6 (5.7)	
		5.1 (200)	25~29	220~260	3.2 (7.0)	
		6.4 (250)	26~32	270~320	4.0 (8.8)	
		7.6 (300)	28~34	300~350	5.1 (11.2)	
		10.2 (400)	34~38	350~400	6.5 (14.2)	

# SF-80W

Type : Rutile

## Conformances

AWS A5.36/ ASME SFA5.36 E81T1-C1A2-W2

JIS Z3320 YFA-58W

## Applications

- Bridge construction
- Civil construction

## Features

- Good weather proof

## Welding Position

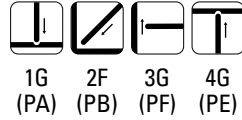

## Current

DC +

## Shielding Gas

100% CO<sub>2</sub>

## Diameter / Packaging

Diameter	Spool			Pac		
	12.5kg (28lbs)	15kg (33lbs)	20kg (44lbs)	100kg (221lbs)	200kg (441lbs)	250kg (551lbs)
1.0 (0.040)						
1.2 (0.045)	✓	✓	✓			
1.4 (0.052)	✓	✓	✓			
1.6 (1/16)	✓	✓	✓			

## Typical Chemical Composition of All-Weld Metal (%)

C	Si	Mn	P	S	Cr	Ni	Cu
0.04	0.4	0.92	0.016	0.012	0.5	0.5	0.4

## Typical Mechanical Properties of All-Weld Metal

YS MPa(lbs/in <sup>2</sup> )	TS MPa(lbs/in <sup>2</sup> )	EL (%)	Temp °C(°F)	CVN-Impact Value J (ft.-lbs)
530 (77,000)	610 (88,600)	26	-30 (-22)	40 (30)

## Typical Operating Procedures

Diameter, Polarity Shielding Gas	CTWD mm (in)	Wire Feed Speed m/min (in/min)	Voltage (volts)	Approx. Current (amps)	Deposition Rate kg/hr (lb/hr)	Efficiency (%)
<b>1.2mm (0.045 in) DC+</b>						
100% CO <sub>2</sub>	25 (1)	4.5 (175)	18~23	120~160	1.5 (3.3)	86~88
		6.4 (250)	19~25	135~175	2.2 (4.8)	
		7.6 (300)	20~26	150~180	2.5 (5.5)	
		8.9 (350)	23~28	175~205	3.0 (6.6)	
		10.2 (400)	25~30	185~220	3.5 (7.6)	
		11.5 (450)	26~31	220~260	3.8 (8.4)	
		12.8 (500)	27~32	250~290	4.4 (9.6)	
15.3 (600)	28~33	280~320	5.3 (11.6)			
<b>1.4mm (0.052 in) DC+</b>						
100% CO <sub>2</sub>	25 (1)	3.8 (150)	20~25	130~170	1.9 (4.1)	85~88
		5.1 (200)	21~26	160~200	2.5 (5.5)	
		6.4 (250)	22~28	180~230	3.0 (6.6)	
		7.6 (300)	23~29	220~260	4.2 (9.2)	
		10.2 (400)	27~32	270~320	5.5 (12.1)	
		12.8 (500)	28~34	300~350	6.0 (13.2)	
<b>1.6mm (1/16 in) DC+</b>						
100% CO <sub>2</sub>	25 (1)	3.2 (125)	22~25	170~210	2.0 (4.4)	84~87
		3.8 (150)	23~26	180~220	2.5 (5.5)	
		5.1 (200)	25~29	220~260	3.2 (7.0)	
		6.4 (250)	26~32	270~320	4.0 (8.8)	
		7.6 (300)	28~34	300~350	5.0 (11.0)	
		10.2 (400)	34~38	350~400	6.4 (14.0)	

# SC-81WM

Type : Rutile

## Conformances

AWS A5.36/ ASME SFA5.36 E81T1-M21A2-W2

## Applications

- Bridge construction
- Civil construction
- Structural fabrication

## Features

- Good weldability, low spatter
- Good bead appearance
- Easy to remove slag
- Corrosion resistance of weathering steels
- Good mechanical properties

## Welding Position

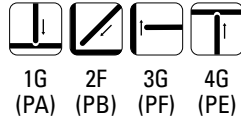

## Current

DC +

## Shielding Gas

Ar + 20~25% CO<sub>2</sub>

## Diameter / Packaging

Diameter	Spool			Pac		
	5kg (11lbs)	15kg (33lbs)	20kg (44lbs)	250kg (551lbs)	300kg (661lbs)	350kg (771lbs)
1.0 (0.040)						
1.2 (0.045)		√				
1.4 (0.052)						
1.6 (1/16)		√				

**Typical Chemical Composition of All-Weld Metal (%)**

C	Si	Mn	P	S	Cr	Ni	Cu
0.04	0.38	1.04	0.005	0.004	0.54	0.55	0.43

**Typical Mechanical Properties of All-Weld Metal**

YS MPa(lbs/in <sup>2</sup> )	TS MPa(lbs/in <sup>2</sup> )	EL (%)	Temp °C(°F)	CVN-Impact Value J (ft.-lbs)
590 (85,600)	650 (94,300)	24.9	-30 (-22)	45 (33)

**Typical Operating Procedures**

Diameter, Polarity Shielding Gas	CTWD mm (in)	Wire Feed Speed m/min (in/min)	Voltage (volts)	Approx. Current (amps)	Deposition Rate kg/hr (lb/hr)	Efficiency (%)
<b>1.2mm (0.045 in) DC+</b>						
Ar + 20-25% CO <sub>2</sub>	25 (1)	<b>All Position</b>				86-88
		4.4 (175)	22-27	110-140	1.6 (3.5)	
		5.1 (200)	23-28	120-150	1.8 (4.0)	
		6.4 (250)	24-29	130-160	2.3 (5.0)	
		7.6 (300)	24-29	160-190	2.7 (6.0)	
		8.9 (350)	25-30	170-200	3.2 (7.0)	
		9.5 (375)	25-30	190-220	3.4 (7.5)	
		<b>Flat &amp; Horizontal</b>				86-88
		10.8 (425)	26-31	210-240	3.8 (8.5)	
		12.1 (475)	27-32	230-260	4.3 (9.5)	
		12.7 (500)	28-33	240-270	4.5 (10.0)	
		<b>1.6mm (1/16 in) DC+</b>				
Ar + 20-25% CO <sub>2</sub>	25 (1)	<b>All Position</b>				86-88
		3.8 (150)	22-27	170-200	2.5 (5.5)	
		4.4 (175)	23-28	180-210	2.9 (6.4)	
		5.1 (200)	24-29	200-230	3.3 (7.3)	
		5.7 (225)	24-29	230-260	3.7 (8.2)	
		6.4 (250)	25-30	250-280	4.2 (9.2)	
		6.9 (275)	25-31	270-300	4.6 (10.1)	
		<b>Flat &amp; Horizontal</b>				86-88
		8.3 (325)	26-32	300-330	5.4 (11.9)	
		8.9 (350)	27-33	330-360	5.8 (12.8)	

SWAW

SAW

GMAW

GTAW

FCAW

Non-FERROUS

APPENDIX

# SC-71SR

Type : Rutile

## Conformances

AWS A5.36/ ASME SFA5.36 E71T1-C1A6-CS2 H4  
E71T1-C1P6-CS2 H4

JIS Z3313 T49 4 T1-1 C AP H5

EN ISO 17632-A T42 4 P C 1 H5

ABS 4Y400SA H5

LR 4Y40S H5

BV SA4Y40 HHH

DNV IVY40MSH5

GL 4Y40H5S

CWB CSA W48 E491T-12J-H4  
(-45 Degree)

CCS 4Y40S H5

## Applications

- Pipe line
- Offshore structure
- Pressure vessel

## Features

- Good impact value at low temperature (As Welded and PHWT)

## Welding Position



1G 2F 3G 4G  
(PA) (PB) (PF) (PE)

## Current

DC +

## Shielding Gas

100% CO<sub>2</sub>

## Diameter / Packaging

Diameter	Spool			Pac		
	12.5kg (28lbs)	15kg (33lbs)	20kg (44lbs)	100kg (221lbs)	200kg (441lbs)	250kg (551lbs)
mm (in)						
1.2 (0.045)	✓	✓	✓			
1.4 (0.052)	✓	✓	✓			



**Typical Chemical Composition of All-Weld Metal (%)**

C	Si	Mn	P	S	Ni
0.05	0.40	1.20	0.011	0.010	0.38

**Typical Mechanical Properties of All-Weld Metal**

YS MPa(lbs/in <sup>2</sup> )	TS MPa(lbs/in <sup>2</sup> )	EL (%)	Temp °C(°F)	CVN-Impact Value J (ft-lbs)	
560 (81,300)	580 (84,200)	28.0	-30 (-22) -40 (-40)	115 (85) 80 (59)	As Welded
540 (78,400)	560 (81,300)	30.0	-30 (-22) -40 (-40)	84 (62) 60 (44)	PWHT (620 @2hr)

**Typical Operating Procedures**

Diameter, Polarity Shielding Gas	CTWD mm (in)	Wire Feed Speed m/min (in/min)	Voltage (volts)	Approx. Current (amps)	Deposition Rate kg/hr (lb/hr)	Efficiency (%)		
<b>1.2mm (0.045 in) DC+</b>								
100% CO <sub>2</sub>	25 (1)	<b>All Position</b>					86-88	
		4.4 (175)	20-25	100-130	1.6 (3.5)			
		5.7 (225)	21-26	120-150	2.0 (4.5)			
		7.0 (275)	22-27	130-160	2.5 (5.5)			
		8.3 (325)	23-28	160-190	2.9 (6.5)			
		8.9 (350)	24-29	170-200	3.2 (7.0)			
		10.2 (400)	25-30	200-230	3.6 (8.0)			
		<b>Flat &amp; Horizontal</b>						
		11.4 (450)	26-31	210-240	4.1 (9.1)			
		12.1 (475)	27-32	230-260	4.3 (9.5)			
		13.3 (525)	28-33	250-280	4.7 (10.4)			
		<b>1.4mm (0.052 in) DC+</b>						
100% CO <sub>2</sub>	25 (1)	<b>All Position</b>					86-88	
		3.8 (150)	22-27	130-160	1.8 (3.9)			
		5.1 (200)	23-28	140-170	2.4 (5.2)			
		6.4 (250)	24-29	160-190	2.9 (6.5)			
		7.6 (300)	26-31	180-210	3.5 (7.8)			
		8.9 (350)	27-32	200-230	4.1 (9.1)			
		9.5 (375)	28-33	220-250	4.4 (9.8)			
		<b>Flat &amp; Horizontal</b>						
		10.8 (425)	30-35	240-270	5.0 (11.1)			
		12.1 (475)	31-36	260-290	5.6 (12.4)			
		12.7 (500)	32-37	310-340	5.9 (13.0)			

SMW

SAW

GMAW

GTAW

FCAW

Non-FERROUS

APPENDIX

# SC-71MSR

Type : Rutile



## Conformances

AWS A5.36/ ASME SFA5.36 E71T1-M21A5-CS2  
E71T1-M21P5-CS2

EN ISO 17632-A T46 4 P M 1 H5

ABS 4Y400SA H5

LR 4Y40S H5

BV SA4Y40M HHH

DNV IVY40MSH5

GL 4Y40H5S

TÜV EN ISO 17632-A - T46 4 P M 1 H5

DB DIN EN ISO 17632-A-T 46 4 P M 2 H5

CE

CWB CSA W48 E491T-12MJ-H8

## Applications

- Pipe line
- Offshore structure
- Pressure vessel

## Features

- Good impact value at low temperature (As Welded and PHWT)

## Welding Position



1G 2F 3G 4G  
(PA) (PB) (PF) (PE)

## Current

DC +

## Shielding Gas

Ar + 20~25% CO<sub>2</sub>

## Diameter / Packaging

Diameter	Spool			Pac		
	12.5kg (28lbs)	15kg (33lbs)	20kg (44lbs)	100kg (221lbs)	200kg (441lbs)	250kg (551lbs)
mm (in)						
1.2 (0.045)	✓	✓	✓			

**Typical Chemical Composition of All-Weld Metal (%)**

C	Si	Mn	P	S	Ni
0.06	0.35	1.24	0.012	0.012	0.45

**Typical Mechanical Properties of All-Weld Metal**

YS MPa(lbs/in <sup>2</sup> )	TS MPa(lbs/in <sup>2</sup> )	EL (%)	Temp °C(°F)	CVN-Impact Value J (ft-lbs)	
542 (78,600)	577 (83,600)	30.0	-40 (-40) -51 (-60)	115 (85) 85 (63)	As Welded
523 (75,700)	552 (80,000)	33.0	-40 (-40) -51 (-60)	90 (66) 70 (52)	PWHT (620 @2hr)

**Typical Operating Procedures**

Diameter, Polarity Shielding Gas	CTWD mm (in)	Wire Feed Speed m/min (in/min)	Voltage (volts)	Approx. Current (amps)	Deposition Rate kg/hr (lb/hr)	Efficiency (%)
<b>1.2mm (0.045 in) DC+</b>						
80% Ar + 20% CO <sub>2</sub>	25 (1)	<b>All Position</b>				86-88
		4.4 (175)	20-25	110-140	1.6 (3.5)	
		5.7 (225)	21-26	120-150	2.0 (4.5)	
		7.0 (275)	22-27	130-160	2.5 (5.5)	
		8.3 (325)	22-27	160-190	2.9 (6.5)	
		8.9 (350)	23-28	170-200	3.2 (7.0)	
		10.2 (400)	24-29	200-230	3.6 (8.0)	
		<b>Flat &amp; Horizontal</b>				
		11.4 (450)	25-31	210-240	4.1 (9.1)	
		12.1 (475)	26-32	230-260	4.3 (9.5)	
13.3 (525)	27-33	250-280	4.7 (10.4)			

SWAW  
SAW  
GMAW  
GTAW  
FCAW  
Non-FERROUS  
APPENDIX

# SC-70ML

Type : Metal-Cored



## Conformances

AWS A5.36/ ASME SFA5.36 E70T15-M21A4-CS1  
JIS Z3313 T49 4 T15-1 M A-U H5  
EN ISO 17632-A-T46 4 M M 2 H5  
ABS 4Y400SA H5  
LR 4Y40S H5  
BV SA4Y40M HHH

DNV IVY40MS H5  
GL 4Y40H5S  
TÜV EN ISO 17362-A - T46 4 M M 2 H5  
DB DIN EN ISO 17632-A-T46 4 M M 2 H5  
CE  
CWB CSA W48 E491C-6MJ-H4

## Applications

- General fabrication
- Heavy equipment
- Offshore structure

## Features

- Good impact value at low temperature
- Semi-automatic and automatic applications
- Good anti-porosity

## Welding Position



1G 2F 3G 4G  
(PA) (PB) (PF) (PE)

## Current

DC +

## Shielding Gas

Ar + 20~25% CO<sub>2</sub>

## Diameter / Packaging

Diameter mm (in)	Spool			Pac		
	5kg (11lbs)	15kg (33lbs)	20kg (44lbs)	250kg (551lbs)	300kg (661lbs)	350kg (771lbs)
1.2 (0.045)	✓	✓	✓	✓	✓	✓
1.4 (0.052)	✓	✓	✓	✓	✓	✓
1.6 (1/16)	✓	✓	✓	✓	✓	✓

**Typical Chemical Composition of All-Weld Metal (%)**

C	Si	Mn	P	S	Ni
0.05	0.57	1.56	0.013	0.010	0.42

**Typical Mechanical Properties of All-Weld Metal**

YS MPa(lbs/in <sup>2</sup> )	TS MPa(lbs/in <sup>2</sup> )	EL (%)	Temp °C(°F)	CVN-Impact Value J (ft.-lbs)
510 (73,950)	560 (81,200)	27	-40 (-40)	70 (52)

**Typical Operating Procedures**

Diameter, Polarity Shielding Gas	CTWD mm (in)	Wire Feed Speed m/min (in/min)	Voltage (volts)	Approx. Current (amps)	Deposition Rate kg/hr (lb/hr)	Efficiency (%)
<b>1.2mm (0.045 in) DC+</b>						
<b>Flat &amp; Horizontal</b>						
80% Ar + 20% CO <sub>2</sub>	19-25 (3/4-1)	7.3 (288)	22 - 26	190-210	3.4 (7.6)	90-96
		9.7 (382)	23 - 27	240-260	4.5 (9.7)	
		12.2 (489)	24 - 30	280-310	5.9 (12.8)	
<b>1.4mm (0.052 in) DC+</b>						
<b>Flat &amp; Horizontal</b>						
80% Ar + 20% CO <sub>2</sub>	19-25 (3/4-1)	6.7 (261)	22 - 26	250-270	3.8 (8.3)	91-96
		7.8 (307)	25 - 31	290-310	4.9 (10.4)	
		9.4 (370)	28 - 32	330-350	5.5 (12.0)	
<b>1.6mm (1/16 in) DC+</b>						
<b>Flat &amp; Horizontal</b>						
80% Ar + 20% CO <sub>2</sub>	25-32 (1-1 1/4)	5.6 (220)	26 - 32	290-310	4.5 (9.3)	92-96
		6.8 (270)	29 - 33	340-350	5.6 (12.1)	
		7.8 (310)	31 - 34	350-370	6.7 (14.3)	

SWAW

SAW

GMAW

GTAW

FCAW

Non-FERROUS

APPENDIX

# SC-80MR

Type : Metal-Cored

## Conformances

AWS A5.36/ ASME SFA5.36 E80T15-M21A8-G

EN ISO 17632-A T 46 6 1.5Ni M M H5

## Applications

- Offshore structure
- Heavy equipment
- General fabrication

## Features

- Suitable for root-pass and multipass welding
- Good impact value at low temperature
- Low spatter
- Good anti-porosity

## Welding Position



1G 2F 3G 4G  
(PA) (PB) (PF-PG) (PE)

## Current

DC +

## Shielding Gas

Ar + 20~25% CO<sub>2</sub>

## Diameter / Packaging

Diameter	Spool			Pac		
	5kg (11lbs)	15kg (33lbs)	20kg (44lbs)	250kg (551lbs)	300kg (661lbs)	350kg (771lbs)
1.2 (0.045)	✓	✓	✓	✓	✓	✓
1.4 (0.052)	✓	✓	✓	✓	✓	✓

**Typical Chemical Composition of All-Weld Metal (%)**

C	Si	Mn	P	S	Ni
0.07	0.35	1.55	0.014	0.010	1.55

**Typical Mechanical Properties of All-Weld Metal**

YS MPa(lbs/in <sup>2</sup> )	TS MPa(lbs/in <sup>2</sup> )	EL (%)	Temp °C(°F)	CVN-Impact Value J (ft-lbs)
612 (88,700)	658 (95,400)	25.5	-60 (-76)	60 (44)

**Typical Operating Procedures**

Diameter, Polarity Shielding Gas	CTWD mm (in)	Wire Feed Speed m/min (in/min)	Voltage (volts)	Approx. Current (amps)	Deposition Rate kg/hr (lb/hr)	Efficiency (%)
<b>1.2mm (0.045 in) DC+</b>						
<b>Flat &amp; Horizontal</b>						
80% Ar + 20% CO <sub>2</sub>	19-25 (3/4-1)	7.8 (307)	22-26	240-260	3.5 (7.5)	90-96
		9.4 (374)	22-27	270-290	4.0 (9.2)	
		10.3 (405)	23-27	300-320	4.5 (10.8)	
<b>1.4mm (0.052 in) DC+</b>						
<b>Flat &amp; Horizontal</b>						
80% Ar + 20% CO <sub>2</sub>	19-25 (3/4-1)	7.2 (283)	24-28	280-300	4.1 (8.9)	94-98
		7.7 (303)	26-29	310-330	4.9 (10.8)	
		10.9 (410)	27-30	350-370	6.6 (14.2)	

SWAW

SAW

GMAW

GTAW

FCAW

Non-FERROUS

APPENDIX

# SC-81M

Type : Rutile

## Conformances

AWS A5.36/ ASME SFA5.36 E81T1-M21A4-Ni1 H4

## Applications

- Construction machinery
- Bridge structures
- Mining

## Features

- Smooth and stable arc with a fast freezing slag
- Good impact value at low temperature(@-40°C )
- Designed for welding with Ar+CO<sub>2</sub> mixture

## Welding Position



1G (PA) 2F (PB) 3G (PF) 4G (PE)

## Current

DC +

## Shielding Gas

Ar+20~25% CO<sub>2</sub>

## Diameter / Packaging

Diameter mm (in)	Spool			Pac		
	12.5kg (28lbs)	15kg (33lbs)	20kg (44lbs)	250kg (551lbs)	300kg (661lbs)	350kg (771lbs)
1.2 (0.045)	✓	✓				
1.4 (0.052)	✓	✓				
1.6 (1/16)	✓	✓				



Typical Chemical Composition of All-Weld Metal(%)

C	Si	Mn	P	S	Ni
0.04	0.34	1.15	0.008	0.008	0.91

Typical Mechanical Properties of All-Weld Metal

YS MPa(lbs/in <sup>2</sup> )	TS MPa(lbs/in <sup>2</sup> )	EL (%)	Temp °C(°F)	CVN-Impact Value J (ft.lbs)
550	590	26.0	-40 (-40)	96 (71)

Typical Operating Procedures

Diameter, Polarity Shielding Gas	CTWD mm (in)	Wire Feed Speed m/min (in/min)	Voltage (volts)	Approx. Current (amps)	Deposition Rate kg/hr (lb/hr)	Efficiency (%)	
<b>1.2mm (0.045 in) DC+</b>							
80%Ar+20% CO <sub>2</sub>	25 (1)	All Position					86-88
		4.4 (175)	22-27	140	1.6 (3.5)		
		5.1 (200)	23-28	150	1.8 (4.0)		
		6.4 (250)	24-29	165	2.3 (5.0)		
		7.6 (300)	24-29	190	2.7 (6.0)		
		8.9 (350)	25-30	205	3.2 (7.0)		
		9.5 (375)	25-30	225	3.4 (7.5)		
		Flat & Horizontal					
		10.8 (425)	26-31	245	3.8 (8.5)		
		12.1 (475)	27-32	265	4.3 (9.5)		
12.7 (500)	28-33	275	4.5 (10.0)				
<b>1.4mm (0.052in), DC +</b>							
80%Ar+20% CO <sub>2</sub>	25 (1)	All Position					86-88
		3.8 (150)	22-27	150	1.8 (3.9)		
		4.7 (180)	23-28	165	2.2 (4.8)		
		5.7 (225)	23-28	190	2.7 (5.9)		
		6.4 (250)	24-29	215	2.9 (6.5)		
		6.9 (275)	24-29	235	3.2 (7.2)		
		7.6 (300)	25-30	255	3.5 (7.8)		
		Flat & Horizontal					
		8.5 (335)	25-31	275	4.0 (8.7)		
		9.5 (375)	26-32	295	4.4 (9.8)		
10.2 (400)	26-33	310	4.7 (10.4)				
<b>1.6mm (1/16 in) DC+</b>							
80%Ar+20% CO <sub>2</sub>	25 (1)	All Position					86-88
		3.8 (150)	22-27	200	2.5 (5.5)		
		4.4 (175)	23-28	210	2.9 (6.4)		
		5.1 (200)	24-29	235	3.3 (7.3)		
		5.7 (225)	24-29	265	3.7 (8.2)		
		6.4 (250)	25-30	285	4.2 (9.2)		
		6.9 (275)	25-31	305	4.6 (10.1)		
		Flat & Horizontal					
		8.3 (325)	26-32	335	5.4 (11.9)		
		8.9 (350)	27-33	365	5.8 (12.8)		

SMW  
SAW  
GMAW  
GTAW  
FCAW  
Non-FERROUS  
APPENDIX

# Supercored 81MAG

Type : Rutile



## Conformances

AWS A5.36/ ASME SFA5.36 E81T1-M21A8-Ni1 H4  
E81T1-M21P5-Ni1 H4

EN ISO 17632-A T46 6 1Ni P M 2 H5

ABS 5Y400SA H5

LR 5Y40S H5

BV SA5Y40M HHH

CWB AWS A5.29 E81T1-Ni1M-H4 (-46 Degree)

DNV VY40MS H5

RINA 5Y40S H5

RS 5Y42SM H5

TÜV EN ISO 17632-A - T 46 6 1Ni P M 2 H5

DB DIN EN ISO 17632-A-T 46 6 1Ni P M 2 H5

CE

## Applications

- Offshore structure
- Shipbuilding
- Mining
- Petrochemical industry

## Features

- Good impact value at low temperature (as welded and PHWT)
- Low hydrogen level (H4)

## Welding Position



1G 2F 3G 4G  
(PA) (PB) (PF-PG) (PE)

## Current

DC +

## Shielding Gas

Ar + 20~25% CO<sub>2</sub>

## Diameter / Packaging

Diameter	Spool			Pac		
	12.5kg (28lbs)	15kg (33lbs)	20kg (44lbs)	100kg (221lbs)	200kg (441lbs)	250kg (551lbs)
1.2 (0.045)	✓	✓	✓			
1.4 (0.052)	✓	✓	✓			
1.6 (1/16)	✓	✓	✓			

## Typical Chemical Composition of All-Weld Metal (%)

C	Si	Mn	P	S	Ni
0.05	0.28	1.20	0.008	0.012	0.93

## Typical Mechanical Properties of All-Weld Metal

YS MPa(lbs/in <sup>2</sup> )	TS MPa(lbs/in <sup>2</sup> )	EL (%)	Temp °C(°F)	CVN-Impact Value J (ft-lbs)	
550 (79,900)	590 (85,700)	26.0	-60 (-76)	60 (44)	As welded
510 (74,100)	570 (82,800)	28.0	-40 (-40)	98 (72)	PWHT (620 @2hr)

## Typical Operating Procedures

Diameter, Polarity Shielding Gas	CTWD mm (in)	Wire Feed Speed m/min (in/min)	Voltage (volts)	Approx. Current (amps)	Deposition Rate kg/hr (lb/hr)	Efficiency (%)	
<b>1.2mm (0.045 in) DC+</b>							
80% Ar + 20% CO <sub>2</sub>	25 (1)	All Position					86-88
		4.4 (175)	22-27	140	1.6 (3.5)		
		5.1 (200)	23-28	150	1.8 (4.0)		
		6.4 (250)	24-29	165	2.3 (5.0)		
		7.6 (300)	24-29	190	2.7 (6.0)		
		8.9 (350)	25-30	205	3.2 (7.0)		
		9.5 (375)	25-30	225	3.4 (7.5)		
		Flat & Horizontal					
		10.8 (425)	26-31	245	3.8 (8.5)		
		12.1 (475)	27-32	265	4.3 (9.5)		
12.7 (500)	28-33	275	4.5 (10.0)				
<b>1.4mm (0.052 in) DC+</b>							
80% Ar + 20% CO <sub>2</sub>	25 (1)	All Position					86-88
		3.8 (150)	22-27	150	1.8 (3.9)		
		4.7 (180)	23-28	165	2.2 (4.8)		
		5.7 (225)	23-28	190	2.7 (5.9)		
		6.4 (250)	24-29	215	2.9 (6.5)		
		6.9 (275)	24-29	235	3.2 (7.2)		
		7.6 (300)	25-30	255	3.5 (7.8)		
		Flat & Horizontal					
		8.5 (335)	25-31	275	4.0 (8.7)		
		9.5 (375)	26-32	295	4.4 (9.8)		
10.2 (400)	26-33	310	4.7 (10.4)				
<b>1.6mm (1/16 in) DC+</b>							
80% Ar + 20% CO <sub>2</sub>	25 (1)	All Position					86-88
		3.8 (150)	22-27	200	2.5 (5.5)		
		4.4 (175)	23-28	210	2.9 (6.4)		
		5.1 (200)	24-29	235	3.3 (7.3)		
		5.7 (225)	24-29	265	3.7 (8.2)		
		6.4 (250)	25-30	285	4.2 (9.2)		
		6.9 (275)	25-31	305	4.6 (10.1)		
		Flat & Horizontal					
		8.3 (325)	26-32	335	5.4 (11.9)		
		8.9 (350)	27-33	365	5.8 (12.8)		

SWAW

SAW

GMAW

GTAW

FCAW

Non-FERROUS

APPENDIX

# Supercored 81-K2

Type : Rutile



## Conformances

AWS A5.36/ ASME SFA5.36 E81T1-C1A8-K2 H4

JIS Z3313 T55 6 T1-1 C A-N3 H5

EN ISO 17632-A T46 6 1.5Ni P C 1 H5

KR 4Y40SG(C1) H5 (-60°C ≥47 J)

ABS 5Y400SA H5

LR 5Y40S H5

BV SA5Y40M HHH

DNV VY40MS H5, NV2-4L, 4-4L

CWB AWS A5.29 E81T1-K2C-H4 (-46 Degree)

NK KSW54Y40G(C)H5

(-60°C ≥47J, ≥34J (Butt))

CCS 5Y40S H5

RINA 5YS H10

RS 5Y40SM H5

GL 6Y40 H5S

CE

## Applications

- Offshore
- Shipbuilding
- General fabrication

## Features

- Good impact value at low temperature
- Smooth and stable arc with a fast freezing slag
- Low hydrogen level (H5)

## Welding Position



1G 2F 3G 4G  
(PA) (PB) (PF-PG) (PE)

## Current

DC +

## Shielding Gas

100% CO<sub>2</sub>

## Diameter / Packaging

Diameter	Spool			Pac		
	12.5kg (28lbs)	15kg (33lbs)	20kg (44lbs)	100kg (221lbs)	200kg (441lbs)	250kg (551lbs)
1.2 (0.045)	✓	✓	✓	✓	✓	✓
1.4 (0.052)	✓	✓	✓	✓	✓	✓
1.6 (1/16)	✓	✓	✓	✓	✓	✓

Typical Chemical Composition of All-Weld Metal (%)

C	Si	Mn	P	S	Ni
0.04	0.35	1.35	0.012	0.011	1.50

Typical Mechanical Properties of All-Weld Metal

YS MPa(lbs/in <sup>2</sup> )	TS MPa(lbs/in <sup>2</sup> )	EL (%)	Temp °C(°F)	CVN-Impact Value J (ft.-lbs)
540 (78,400)	620 (90,000)	28.0	-30 (-22) -60 (-76)	110 (81) 60 (44)

Typical Operating Procedures

Diameter, Polarity Shielding Gas	CTWD mm (in)	Wire Feed Speed m/min (in/min)	Voltage (volts)	Approx. Current (amps)	Deposition Rate kg/hr (lb/hr)	Efficiency (%)	
<b>1.2mm (0.045 in) DC+</b>							
100% CO <sub>2</sub>	25 (1)	<b>All Position</b>					86-88
		4.4 (175)	23-28	140	1.6 (3.5)		
		5.1 (200)	24-29	150	1.8 (4.0)		
		6.4 (250)	25-30	165	2.3 (5.0)		
		7.6 (300)	25-30	190	2.7 (6.0)		
		8.9 (350)	26-31	205	3.2 (7.0)		
		9.5 (375)	26-31	225	3.4 (7.5)		
		10.8 (425)	27-32	245	3.8 (8.5)		
		<b>Flat &amp; Horizontal</b>					
		12.1 (475)	28-33	265	4.9 (10.8)		
12.7 (500)	29-34	275	5.2 (11.4)				
<b>1.4mm (0.052 in) DC+</b>							
100% CO <sub>2</sub>	25 (1)	<b>All Position</b>					86-88
		3.8 (150)	23-28	150	1.8 (3.9)		
		4.7 (180)	24-29	165	2.2 (4.8)		
		5.7 (225)	24-29	190	2.7 (5.9)		
		6.4 (250)	25-30	215	2.9 (6.5)		
		6.9 (275)	25-30	235	3.2 (7.2)		
		7.6 (300)	26-31	255	3.5 (7.8)		
		<b>Flat &amp; Horizontal</b>					
		8.5 (335)	26-31	275	4.0 (8.7)		
		9.5 (375)	27-32	295	4.4 (9.8)		
10.2 (400)	27-34	310	4.7 (10.4)				
<b>1.6mm (1/16 in) DC+</b>							
100% CO <sub>2</sub>	25 (1)	<b>All Position</b>					86-88
		3.8 (150)	24-29	200	2.5 (5.5)		
		4.4 (175)	24-30	210	2.9 (6.4)		
		5.1 (200)	25-30	235	3.3 (7.3)		
		5.7 (225)	25-31	265	3.7 (8.2)		
		6.4 (250)	26-31	285	4.2 (9.2)		
		6.9 (275)	26-32	305	4.6 (10.1)		
		<b>Flat &amp; Horizontal</b>					
		8.3 (325)	27-32	335	5.4 (11.9)		
		8.9 (350)	28-34	365	5.8 (12.8)		

SMW

SAW

GMAW

GTAW

FCAW

Non-FERROUS

APPENDIX

# SC-460

Type : Rutile

## Conformances

AWS A5.36/ ASME SFA5.36 E81T1-C1A6-K2  
JIS Z3313 T55 6 T1-1 C A-N3 H5  
EN ISO 17632-A T46 6 1.5Ni P C 1 H5  
KR 5Y46SG(C1) H5  
ABS 5YQ460SA H5  
LR 5Y46 H5

BV SA5Y46 HHH  
DNV VY46MS(H5)  
GL 6Y46 H5  
NK KSW5Y46G(C)H5  
KSW63Y47G(C)H5  
(-20°C≥53J)

## Applications

- Shipbuilding
- Structural fabrication
- Offshore structure

## Features

- Good impact value at low temperature service steel
- Low hydrogen level (H5)
- High tensile steel (EH47 Grade)

## Welding Position



1G 2F 3G 4G  
(PA) (PB) (PF) (PE)

## Current

DC +

## Shielding Gas

100% CO<sub>2</sub>

## Diameter / Packaging

Diameter	Spool			Pac		
	12.5kg (28lbs)	15kg (33lbs)	20kg (44lbs)	100kg (221lbs)	200kg (441lbs)	250kg (551lbs)
1.2 (0.045)	✓	✓	✓			
1.4 (0.052)	✓	✓	✓			

**Typical Chemical Composition of All-Weld Metal (%)**

C	Si	Mn	P	S	Ni
0.06	0.35	1.20	0.008	0.011	1.50

**Typical Mechanical Properties of All-Weld Metal**

YS MPa(lbs/in <sup>2</sup> )	TS MPa(lbs/in <sup>2</sup> )	EL (%)	Temp °C(°F)	CVN-Impact Value J (ft.-lbs)
580 (84,200)	630 (91,400)	26.0	-60 (-76)	60 (44)

**Typical Operating Procedures**

Diameter, Polarity Shielding Gas	CTWD mm (in)	Wire Feed Speed m/min (in/min)	Voltage (volts)	Approx. Current (amps)	Deposition Rate kg/hr (lb/hr)	Efficiency (%)
<b>1.2mm (0.045 in) DC+</b>						
100% CO <sub>2</sub>	25 (1)	<b>All Position</b>				86-88
		4.4 (175)	23-28	120-140	1.6 (3.5)	
		5.1 (200)	24-29	130-150	1.8 (4.0)	
		6.4 (250)	25-30	140-160	2.3 (5.0)	
		7.6 (300)	25-30	160-190	2.7 (6.0)	
		8.9 (350)	26-31	190-210	3.2 (7.0)	
		9.5 (375)	26-31	210-230	3.4 (7.5)	
		10.8 (425)	27-32	220-240	3.8 (8.5)	
		<b>Flat &amp; Horizontal</b>				
		12.1 (475)	28-33	240-270	4.9 (10.8)	
12.7 (500)	29-34	250-280	5.2 (11.4)			
<b>1.4mm (0.052 in) DC+</b>						
100% CO <sub>2</sub>	25 (1)	<b>All Position</b>				86-88
		3.8 (150)	23-28	120-150	1.8 (3.9)	
		4.7 (180)	24-29	150-170	2.2 (4.8)	
		5.7 (225)	24-29	170-190	2.7 (5.9)	
		6.4 (250)	25-30	190-210	2.9 (6.5)	
		6.9 (275)	25-30	210-240	3.2 (7.2)	
		7.6 (300)	26-31	220-250	3.5 (7.8)	
		<b>Flat &amp; Horizontal</b>				
		8.5 (335)	26-31	250-280	4.0 (8.7)	
		9.5 (375)	27-32	280-300	4.4 (9.8)	
10.2 (400)	27-34	290-310	4.7 (10.4)			

SWAW

SAW

GMAW

GTAW

FCAW

Non-FERROUS

APPENDIX

# SC-81LT

Type : Rutile

## Conformances

AWS A5.36/ ASME SFA5.36 E81T1-C1A6-K2

JIS Z3313 T55 6 T1-1 C A-N3 H5

EN ISO 17632-A T46 6 1.5Ni P C 1 H5

ABS 5Y, 5Y400SA H5

LR 5Y40S H5

DNV VY40MSH5, NV4-4L

## Applications

- Shipbuilding
- Offshore structure
- Structural fabrication

## Features

- Good impact value at low temperature
- Smooth and stable arc with a fast freezing slag
- Good CTOD value

## Welding Position



1G 2F 3G 4G  
(PA) (PB) (PF) (PE)

## Current

DC +

## Shielding Gas

100% CO<sub>2</sub>

## Diameter / Packaging

Diameter	Spool			Pac		
	12.5kg (28lbs)	15kg (33lbs)	20kg (44lbs)	100kg (221lbs)	200kg (441lbs)	250kg (551lbs)
1.2 (0.045)	✓					
1.4 (0.052)	✓					



**Typical Chemical Composition of All-Weld Metal (%)**

C	Si	Mn	P	S	Ni
0.04	0.26	1.20	0.010	0.010	1.50

**Typical Mechanical Properties of All-Weld Metal**

YS MPa(lbs/in <sup>2</sup> )	TS MPa(lbs/in <sup>2</sup> )	EL (%)	Temp °C(°F)	CVN-Impact Value J (ft.-lbs)
520 (75,500)	610 (88,600)	28.0	-40 (-40) -60 (-76)	120 (89) 85 (63)

**Typical Operating Procedures**

Diameter, Polarity Shielding Gas	CTWD mm (in)	Wire Feed Speed m/min (in/min)	Voltage (volts)	Approx. Current (amps)	Deposition Rate kg/hr (lb/hr)	Efficiency (%)
<b>1.2mm (0.045 in) DC+</b>						
100% CO <sub>2</sub>	25 (1)	<b>All Position</b>				86-88
		4.4 (175)	23-28	120-140	1.6 (3.5)	
		5.1 (200)	24-29	130-150	1.8 (4.0)	
		6.4 (250)	25-30	140-160	2.3 (5.0)	
		7.6 (300)	25-30	160-190	2.7 (6.0)	
		8.9 (350)	26-31	190-210	3.2 (7.0)	
		9.5 (375)	26-31	210-230	3.4 (7.5)	
		10.8 (425)	27-32	220-240	3.8 (8.5)	
		<b>Flat &amp; Horizontal</b>				
		12.1 (475)	28-33	240-270	4.9 (10.8)	
12.7 (500)	29-34	250-280	5.2 (11.4)			
<b>1.4mm (0.052 in) DC+</b>						
100% CO <sub>2</sub>	25 (1)	<b>All Position</b>				86-88
		3.8 (150)	23-28	120-150	1.8 (3.9)	
		4.7 (180)	24-29	150-170	2.2 (4.8)	
		5.7 (225)	24-29	170-190	2.7 (5.9)	
		6.4 (250)	25-30	190-210	2.9 (6.5)	
		6.9 (275)	25-30	210-240	3.2 (7.2)	
		7.6 (300)	26-31	220-250	3.5 (7.8)	
		<b>Flat &amp; Horizontal</b>				
		8.5 (335)	26-31	250-280	4.0 (8.7)	
		9.5 (375)	27-32	280-300	4.4 (9.8)	
10.2 (400)	27-34	290-310	4.7 (10.4)			

SWAW

SAW

GMAW

GTAW

FCAW

Non-FERROUS

APPENDIX

# SC-81Ni2

Type : Rutile

## Conformances

AWS A5.36/ ASME SFA5.36 E81T1-C1A8-Ni2  
JIS Z3313 T55 6 T1-1 C A-N5 H5  
EN ISO 17632-A T46 6 2Ni P C 1 H5  
KR 5Y46SG(C1) H5  
ABS 5YQ460SA H5

BV SA5Y46 HHH  
DNV VY46MS(H5)  
GL 6Y46S H5  
NK KSW63Y47G(C)H5

## Applications

- Shipbuilding
- Offshore structure
- Structural fabrication

## Features

- Good impact value at low temperature
- Good CTOD value

## Welding Position



1G 2F 3G 4G  
(PA) (PB) (PF) (PE)

## Current

DC +

## Shielding Gas

100% CO<sub>2</sub>

## Diameter / Packaging

Diameter	Spool			Pac		
	12.5kg (28lbs)	15kg (33lbs)	20kg (44lbs)	100kg (221lbs)	200kg (441lbs)	250kg (551lbs)
1.2 (0.045)	✓				✓	
1.4 (0.052)	✓				✓	

**Typical Chemical Composition of All-Weld Metal (%)**

C	Si	Mn	P	S	Ni
0.05	0.27	1.21	0.010	0.010	2.20

**Typical Mechanical Properties of All-Weld Metal**

YS MPa(lbs/in <sup>2</sup> )	TS MPa(lbs/in <sup>2</sup> )	EL (%)	Temp °C(°F)	CVN-Impact Value J (ft.-lbs)
590 (85,600)	630 (91,400)	25.0	-40 (-40) -60 (-76)	100 (74) 80 (59)

**Typical Operating Procedures**

Diameter, Polarity Shielding Gas	CTWD mm (in)	Wire Feed Speed m/min (in/min)	Voltage (volts)	Approx. Current (amps)	Deposition Rate kg/hr (lb/hr)	Efficiency (%)
<b>1.2mm (0.045 in) DC+</b>						
100% CO <sub>2</sub>	25 (1)	<b>All Position</b>				86-88
		4.4 (175)	23-28	110-140	1.6 (3.5)	
		5.1 (200)	24-29	120-150	1.8 (4.0)	
		6.4 (250)	25-30	130-160	2.3 (5.0)	
		7.6 (300)	25-30	160-190	2.7 (6.0)	
		8.9 (350)	26-31	170-210	3.2 (7.0)	
		9.5 (375)	26-31	190-230	3.4 (7.5)	
		10.8 (425)	27-32	220-250	3.8 (8.5)	
		<b>Flat &amp; Horizontal</b>				
		12.1 (475)	28-33	240-270	4.9 (10.8)	
12.7 (500)	29-34	250-280	5.2 (11.4)			
<b>1.4mm (0.052 in) DC+</b>						
100% CO <sub>2</sub>	25 (1)	<b>All Position</b>				86-88
		3.8 (150)	23-28	120-150	1.8 (3.9)	
		4.7 (180)	24-29	130-160	2.2 (4.8)	
		5.7 (225)	24-29	160-190	2.7 (5.9)	
		6.4 (250)	25-30	190-220	2.9 (6.5)	
		6.9 (275)	25-30	200-230	3.2 (7.2)	
		7.6 (300)	26-31	220-250	3.5 (7.8)	
		<b>Flat &amp; Horizontal</b>				
		8.5 (335)	26-31	240-270	4.0 (8.7)	
		9.5 (375)	27-32	260-290	4.4 (9.8)	
10.2 (400)	27-34	280-310	4.7 (10.4)			

SWAW

SAW

GMAW

GTAW

FCAW

Non-FERROUS

APPENDIX

# SC-81Ni2M

Type : Rutile

## Conformances

AWS A5.36/ ASME SFA5.36 E81T1-M21A8-Ni2

JIS Z3313 T55 6 T1-1 M A-N5 H5

EN ISO 17632-A T46 6 2Ni P M 2 H5

DNV VY46MS(H5)

BV SA5Y46 HHH

## Applications

- Offshore structure
- Shipbuilding

## Features

- Good impact value at low temperature
- Good CTOD value

## Welding Position



1G 2F 3G 4G  
(PA) (PB) (PF) (PE)

## Current

DC +

## Shielding Gas

Ar + 20~25% CO<sub>2</sub>

## Diameter / Packaging

Diameter	Spool			Pac		
	12.5kg (28lbs)	15kg (33lbs)	20kg (44lbs)	100kg (221lbs)	200kg (441lbs)	250kg (551lbs)
1.2 (0.045)	✓					
1.4 (0.052)	✓					

**Typical Chemical Composition of All-Weld Metal (%)**

C	Si	Mn	P	S	Ni
0.05	0.24	1.15	0.010	0.010	2.25

**Typical Mechanical Properties of All-Weld Metal**

YS MPa(lbs/in <sup>2</sup> )	TS MPa(lbs/in <sup>2</sup> )	EL (%)	Temp °C(°F)	CVN-Impact Value J (ft.-lbs)
580 (84,200)	620 (90,000)	24.8	-50 (-58) -60 (-76)	110 (81) 90 (66)

**Typical Operating Procedures**

Diameter, Polarity Shielding Gas	CTWD mm (in)	Wire Feed Speed m/min (in/min)	Voltage (volts)	Approx. Current (amps)	Deposition Rate kg/hr (lb/hr)	Efficiency (%)	
<b>1.2mm (0.045 in) DC+</b>							
80% Ar + 20% CO <sub>2</sub>	25 (1)	<b>All Position</b>					86-88
		4.4 (175)	23-28	110-140	1.6 (3.5)		
		5.1 (200)	24-29	120-150	1.8 (4.0)		
		6.4 (250)	25-30	130-160	2.3 (5.0)		
		7.6 (300)	25-30	160-190	2.7 (6.0)		
		8.9 (350)	26-31	170-200	3.2 (7.0)		
		9.5 (375)	26-31	190-220	3.4 (7.5)		
		10.8 (425)	27-32	210-240	3.8 (8.5)		
		<b>Flat &amp; Horizontal</b>					
		12.1 (475)	28-33	230-260	4.9 (10.8)		
12.7 (500)	29-34	240-270	5.2 (11.4)				

SWAW

SAW

GMAW

GTAW

FCAW

Non-FERROUS

APPENDIX

# Supercored 81-K2MAG

Type : Rutile



## Conformances

AWS A5.36/ ASME SFA5.36 E81T1-M21A8-K2  
JIS Z3313 T55 6 T1-1 M A-N3 H5  
EN ISO 17632-A T46 6 1.5Ni P M 2 H5  
ABS 5Y400SA H5  
LR 5Y40S H5  
BV SA5Y40M HHH

DNV VY40MS H5  
GL 6Y40S H5  
RS 5Y42SM H5  
TÜV EN ISO 17632-A - T46 6 1.5 Ni P M 2  
CE  
DB DIN EN ISO 17632-A-T46 6 1.5Ni P M 2

## Applications

- Offshore structure
- Shipbuilding

## Features

- Good impact value at low temperature
- Smooth arc and low spatter level

## Welding Position



1G 2F 3G 4G  
(PA) (PB) (PF) (PE)

## Current

DC +

## Shielding Gas

Ar + 20~25% CO<sub>2</sub>

## Diameter / Packaging

Diameter	Spool			Pac		
	12.5kg (28lbs)	15kg (33lbs)	20kg (44lbs)	100kg (221lbs)	200kg (441lbs)	250kg (551lbs)
mm (in)						
1.2 (0.045)	✓	✓	✓			

## Typical Chemical Composition of All-Weld Metal (%)

C	Si	Mn	P	S	Ni
0.03	0.35	1.25	0.012	0.010	1.55

## Typical Mechanical Properties of All-Weld Metal

YS MPa(lbs/in <sup>2</sup> )	TS MPa(lbs/in <sup>2</sup> )	EL (%)	Temp °C(°F)	CVN-Impact Value J (ft.-lbs)
590 (85,600)	610 (88,500)	27.0	-30 (-22) -60 (-76)	110 (81) 70 (52)

## Typical Operating Procedures

Diameter, Polarity Shielding Gas	CTWD mm (in)	Wire Feed Speed m/min (in/min)	Voltage (volts)	Approx. Current (amps)	Deposition Rate kg/hr (lb/hr)	Efficiency (%)	
<b>1.2mm (0.045 in) DC+</b>							
80% Ar + 20% CO <sub>2</sub>	25 (1)	<b>All Position</b>					86-88
		4.4 (175)	20-25	110-140	1.6 (3.5)		
		5.7 (225)	21-26	120-150	2.0 (4.5)		
		7.0 (275)	22-27	130-160	2.5 (5.5)		
		8.3 (325)	22-27	160-190	2.9 (6.5)		
		8.9 (350)	23-28	170-200	3.2 (7.0)		
		10.2 (400)	24-29	200-230	3.6 (8.0)		
		<b>Flat &amp; Horizontal</b>					
		11.4 (450)	25-31	210-240	4.1 (9.1)		
		12.1 (475)	26-32	230-260	4.3 (9.5)		
13.3 (525)	27-33	250-280	4.7 (10.4)				

SWAW

SAW

GMAW

GTAW

FCAW

Non-FERROUS

APPENDIX

# SC-80K2

Type : Semi-Metal

## Conformances

AWS A5.36/ ASME SFA5.36 E80T1-C1A8-K2 H4  
 JIS Z3313 T55 6 T15-0 C A-N3 H5  
 EN ISO 17632-A-T 46 6 1.5Ni R C 3 H5  
 KR RSW54Y40MG(C)HHH  
 ABS 5Y400SA H5  
 LR 4Y40S H5  
 BV SA5Y40 HHH

DNV VY40MS H5, NV4-4L  
 GL 6Y40 H5S  
 NK KAW54Y40MG(C),  
 KSW54Y40MG(C)H5  
 (-60°C≥34J)  
 RS 5Y40S H5

## Applications

- LPG and LNG storage tank
- Shipbuilding
- Offshore structure

## Features

- High speed single or twin tandem welding
- H5 diffusible hydrogen levels
- Low temperature service

## Welding Position

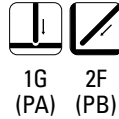

## Current

DC +

## Shielding Gas

100% CO<sub>2</sub>

## Diameter / Packaging

Diameter	Spool			Pac		
	5kg (11lbs)	15kg (33lbs)	20kg (44lbs)	250kg (551lbs)	300kg (661lbs)	500kg (771lbs)
1.2 (0.045)		✓		✓	✓	✓
1.4 (0.052)		✓		✓	✓	✓



**Typical Chemical Composition of All-Weld Metal (%)**

C	Si	Mn	P	S	Ni
0.06	0.43	1.45	0.011	0.008	1.57

**Typical Mechanical Properties of All-Weld Metal**

YS MPa(lbs/in <sup>2</sup> )	TS MPa(lbs/in <sup>2</sup> )	EL (%)	Temp °C(°F)	CVN-Impact Value J (ft.-lbs)
550 (79,900)	590 (85,700)	25	-60 (-76)	53 (39)

**Typical Operating Procedures**

Diameter, Polarity Shielding Gas	CTWD mm (in)	Wire Feed Speed m/min (in/min)	Voltage (volts)	Approx. Current (amps)	Deposition Rate kg/hr (lb/hr)	Efficiency (%)
<b>1.2mm (0.045 in) DC+</b>						
100% CO <sub>2</sub>	20-25 (51/64~1)	10.4 (410)	26	200	3.5 (7.7)	85-87
		12.7 (500)	30	250	4.7 (10.4)	87-89
		15.3 (600)	33	300	6.3 (13.9)	91-93
<b>1.4mm (0.052 in) DC+</b>						
100% CO <sub>2</sub>	20-25 (51/64~1)	12.0 (470)	31	300	5.6 (12.3)	90-92
		13.3 (520)	36	350	6.7 (14.8)	91-93

SWAW

SAW

GMAW

GTAW

FCAW

Non-FERROUS

APPENDIX

# SC-81B2

Type : Rutile

## Conformances

AWS A5.36/ ASME SFA5.36 E81T1-C1PZ-B2

EN ISO 17632-A-T CrMo1 P C 2

## Applications

- Petrochemical industry
- Pressure vessel

## Features

- Stable arc and low spatter level

## Welding Position



1G 2F 3G 4G  
(PA) (PB) (PF) (PE)

## Current

DC +

## Shielding Gas

100% CO<sub>2</sub>

## Diameter / Packaging

Diameter	Spool
mm (in)	15kg (33lbs)
1.2 (0.045)	✓
1.4 (0.052)	✓
1.6 (1/16)	✓

## Typical Chemical Composition of All-Weld Metal (%)

C	Si	Mn	P	S	Cr	Mo
0.066	0.41	0.83	0.016	0.017	1.19	0.51

## Typical Mechanical Properties of All-Weld Metal

YS MPa(lbs/in <sup>2</sup> )	TS MPa(lbs/in <sup>2</sup> )	EL (%)	PWHT
575 (83,500)	656 (95,200)	22.4	690±15°C X 1Hr

## Typical Operating Procedures

Diameter in (mm)	Amp-Volt Range	Typical	Stickout in (mm)
1.2 (0.045) DC+	150 ~ 260A 24-30V	200A 26V	15 ~ 25 (5/8 ~ 1)
1.4 (0.052) DC+	180 ~ 280A 25-32V	220A 26V	15 ~ 25 (5/8 ~ 1)
1.6 (1/16) DC+	200 ~ 300A 25-32V	240A 27V	15 ~ 25 (5/8 ~ 1)

# SC-91B3

Type : Rutile

## Conformances

AWS A5.36/ ASME SFA5.36E91T1-C1PZ-B3

EN ISO 17632-A-T CrMo2 P C 2

## Applications

- Petrochemical industry
- Pressure vessel

## Features

- Stable arc and low spatter level

## Welding Position



1G (PA) 2F (PB) 3G (PF) 4G (PE)

## Current

DC +

## Shielding Gas

100% CO<sub>2</sub>

## Diameter / Packaging

Diameter	Spool
mm (in)	15kg (33lbs)
1.2 (0.045)	√
1.4 (0.052)	√
1.6 (1/16)	√

## Typical Chemical Composition of All-Weld Metal (%)

C	Si	Mn	P	S	Cr	Mo
0.063	0.47	0.83	0.022	0.017	2.32	0.99

## Typical Mechanical Properties of All-Weld Metal

YS MPa(lbs/in <sup>2</sup> )	TS MPa(lbs/in <sup>2</sup> )	EL (%)	PWHT
643 (93,300)	730 (106,000)	20.0	690±15°C X 1Hr

## Typical Operating Procedures

Diameter in (mm)	Amp-Volt Range	Typical	Stickout in (mm)
1.2 (0.045) DC+	150 ~ 260A 24-30V	200A 26V	15 ~ 25 (5/8 ~ 1)
1.4 (0.052) DC+	180 ~ 280A 25-32V	220A 26V	15 ~ 25 (5/8 ~ 1)
1.6 (1/16) DC+	200 ~ 300A 25-32V	240A 27V	15 ~ 25 (5/8 ~ 1)

# SC-91B9

Type : Rutile

## Conformances

AWS A5.36/ ASME SFA5.36 E91T1-C1PZ-B91 H4  
E91T1-M21PZ-B91 H4

## Applications

- Petrochemical industry
- Pressure vessel

## Features

- Good performance in all positions
- Good heat-resistance(P91 grade steel)

## Welding Position



1G 2F 3G 4G  
(PA) (PB) (PF) (PE)

## Current

DC +

## Shielding Gas

Ar + 20~25% CO<sub>2</sub>  
100% CO<sub>2</sub>

## Diameter / Packaging

Diameter	Spool		
	5kg (11lbs)	12.5kg (27.6lbs)	15kg (33lbs)
1.2 (0.045)	✓	✓	✓
1.6 (1/16)		✓	✓

## Typical Chemical Composition of All-Weld Metal (%)

C	Si	Mn	Cr	Ni	Mo	V	Nb	N	HDM (ml/100g)
0.09	0.1	0.5	9.0	0.5	1.0	0.2	0.05	0.03	2.01

## Typical Mechanical Properties of All-Weld Metal

YS MPa(lbs/in <sup>2</sup> )	TS MPa(lbs/in <sup>2</sup> )	EL (%)	Temp °C(°F)	CVN-Impact Value J (ft-lbs)	Condition
560 (81,300)	740 (107,400)	21	20 (68)	30 (22)	SR1:2h/760°C

## Typical Operating Procedures

Diameter in (mm)	Amp-Volt Range	Typical	Stickout in (mm)
1.2 (0.045) DC+	150 ~ 260A 24~30V	200A 26V	15 ~ 25 (5/8 ~ 1)
1.4 (0.052) DC+	180 ~ 280A 25~32V	220A 26V	15 ~ 25 (5/8 ~ 1)
1.6 (1/16) DC+	200 ~ 300A 25~32V	240A 27V	15 ~ 25 (5/8 ~ 1)

# SC-80D2

Type : Metal-Cored

## Conformances

AWS A5.36/ ASME SFA5.36 E80T15-M21A0-G

JIS Z3318 YFM-G

EN ISO 17632-A-T 46 0 MnMo M M 3

## Applications

- Heavy equipment
- Petrochemical industry
- Pressure vessel

## Features

- Smooth and stable arc
- Low spatter
- Good crack resistance
- Good impact value
- Good porosity resistance

## Welding Position



1G 2F  
(PA) (PB)

## Current

DC +

## Shielding Gas

Ar + 20~25% CO<sub>2</sub>

## Diameter / Packaging

Diameter	Spool			Pac		
	5kg (11lbs)	15kg (33lbs)	20kg (44lbs)	250kg (551lbs)	300kg (661lbs)	350kg (771lbs)
mm (in)	✓	✓	✓	✓	✓	✓
1.2 (0.045)	✓	✓	✓	✓	✓	✓

SMW

SAW

GMAW

GTAW

FCAW

Non-FERROUS

APPENDIX

**Typical Chemical Composition of All-Weld Metal (%)**

C	Si	Mn	P	S	Mo
0.05	0.60	1.65	0.012	0.010	0.51

**Typical Mechanical Properties of All-Weld Metal**

YS MPa(lbs/in <sup>2</sup> )	TS MPa(lbs/in <sup>2</sup> )	EL (%)	Temp °C(°F)	CVN-Impact Value J (ft-lbs)
590 (85,600)	660 (95,700)	28	-20 (-4)	70 (52)

**Typical Operating Procedures**

Diameter, Polarity Shielding Gas	CTWD mm (in)	Wire Feed Speed m/min (in/min)	Voltage (volts)	Approx. Current (amps)	Deposition Rate kg/hr (lb/hr)	Efficiency (%)
<b>1.2mm (0.045 in) DC+</b>						
<b>Flat &amp; Horizontal</b>						
80% Ar + 20% CO <sub>2</sub>	19-25 (3/4-1)	7.8 (307)	22~26	240~260	3.5 (7.5)	90~96
		9.4 (374)	22~27	270~290	4.0 (9.2)	
		10.3 (405)	23~27	300~320	4.5 (10.8)	

# Supercored 1CM

Type : Metal-Cored

## Conformances

AWS A5.36/ ASME SFA5.36 E80T15-M21PZ-G(B2)

JIS Z3318 YF1CM-G

EN ISO 17634-A-T CrMo1 M M 3

## Applications

- Petrochemical industry
- Pressure vessel

## Features

- Smooth and stable arc
- Low spatter
- Good porosity resistance

## Welding Position



1G 2F  
(PA) (PB)

## Current

DC +

## Shielding Gas

Ar + 20~25% CO<sub>2</sub>

## Diameter / Packaging

Diameter	Spool			Pac		
	5kg (11lbs)	15kg (33lbs)	20kg (44lbs)	250kg (551lbs)	300kg (661lbs)	350kg (771lbs)
mm (in)	✓	✓	✓	✓	✓	✓
1.2 (0.045)	✓	✓	✓	✓	✓	✓

SWAW

SAW

GMAW

GTAW

FCAW

Non-FERROUS

APPENDIX

## Typical Chemical Composition of All-Weld Metal (%)

C	Si	Mn	P	S	Cr	Mo
0.07	0.39	0.81	0.013	0.010	1.25	0.51

## Typical Mechanical Properties of All-Weld Metal

YS MPa(lbs/in <sup>2</sup> )	TS MPa(lbs/in <sup>2</sup> )	EL (%)	Temp °C(°F)	CVN-Impact Value J (ft-lbs)	PWHT
560 (81,300)	630 (91,400)	20	0 (32)	90 (66)	620/1Hr
510 (74,100)	600 (87,100)	25	0 (32)	110 (81)	620/8Hr

## Typical Operating Procedures

Diameter, Polarity Shielding Gas	CTWD mm (in)	Wire Feed Speed m/min (in/min)	Voltage (volts)	Approx. Current (amps)	Deposition Rate kg/hr (lb/hr)	Efficiency (%)
<b>1.2mm (0.045 in) DC+</b>						
<b>Flat &amp; Horizontal</b>						
80% Ar + 20% CO <sub>2</sub>	19-25 (3/4-1)	9.5 (374)	26-29	230-250	3.9 (8.6)	90-96
		12.2 (480)	28-31	280-300	5.3 (11.6)	
		14.8 (582)	30-33	320-340	6.5 (14.2)	



# Supershield 11

Type : Self-Shielded

## Conformances

AWS A5.36/ ASME SFA5.36 E71T11-AZ-CS3

JIS Z3313 T49 T14-1 N A

EN ISO 17632-A-T 42 Z Z Z N 1

## Applications

- General fabrication
- Galvanized steel
- Civil construction

## Features

- All position self-shielded flux cored wire
- Single & multi-pass welding of thin plate

## Welding Position



1G (PA) 2F (PB) 3G (PF) 4G (PE)

## Current

DC -

## Shielding Gas

No shielding gas

## Diameter / Packaging

Diameter mm (in)	Spool	
	15kg (33lbs)	20kg (44lbs)
1.0 (0.040)	✓	✓
1.2 (0.045)	✓	✓
1.4 (0.052)	✓	✓
1.6 (1/16)	✓	✓

## Typical Chemical Composition of All-Weld Metal (%)

C	Si	Mn	P	S	Al
0.19	0.35	0.6	0.011	0.006	1.2

## Typical Mechanical Properties of All-Weld Metal

YS MPa(lbs/in <sup>2</sup> )	TS MPa(lbs/in <sup>2</sup> )	EL (%)
520 (75,400)	590 (85,500)	21

## Typical Operating Procedures

Diameter, Polarity Shielding Gas	CTWD mm (in)	Wire Feed Speed m/min (in/min)	Voltage (volts)	Approx. Current (amps)	Deposition Rate kg/hr (lb/hr)	Efficiency (%)
<b>1.6mm (1/16 in) DC+</b>						
No shielding gas	25 (1)	2.5 (98)	14~18	130~180	0.9 (2.0)	77~81
		3.4 (134)	16~20	180~240	1.2 (2.6)	
		4.0 (157)	18~23	220~280	2.2 (4.8)	

SMW

SAW

GMW

GTAW

FCAW

Non-FERROUS

APPENDIX

# Supershield 71GS

Type : Self-Shielded

## Conformances

AWS A5.36/ ASME SFA5.36 E70TGS

JIS Z3313 T49 T14-1 N S

EN ISO 17632-A-T 42 Z Z V N 1

## Applications

- General fabrications
- Galvanized steel
- Civil construction

## Features

- All position self-shielded flux cored wire
- Single pass welding of thin plate

## Welding Position



1G 2F 3G 4G  
(PA) (PB) (PF) (PE)

## Current

DC -

## Shielding Gas

No shielding gas

## Diameter / Packaging

Diameter mm (in)	Spool	
	15kg (33lbs)	20kg (44lbs)
1.0 (0.040)	√	√
1.2 (0.045)	√	√
1.4 (0.052)	√	√
1.6 (1/16)	√	√

## Typical Chemical Composition of All-Weld Metal (%)

C	Si	Mn	P	S	Al
0.26	0.5	0.91	0.016	0.014	2.05

## Typical Mechanical Properties of All-Weld Metal

	AS welded
Transverse Tensile Strength MPa(psi) (Specimen broken in the base metal)	586 (85,000)
Longitudinal Guided Bend Test	Satisfactory

## Typical Operating Procedures

Diameter, Polarity Shielding Gas	CTWD mm (in)	Wire Feed Speed m/min (in/min)	Voltage (volts)	Approx. Current (amps)	Deposition Rate kg/hr (lb/hr)	Efficiency (%)
<b>1.6mm (1/16 in) DC+</b>						
No shielding gas	25 (1)	2.4 (94)	14~18	130~180	0.9 (2.0)	76~80
		3.3 (130)	16~20	180~240	1.1 (2.4)	
		4.0 (157)	18~23	220~280	2.1 (4.6)	

# Supershield 4

Type : Self-Shielded

## Conformances

AWS A5.36/ ASME SFA5.36 E70T4-AZ-CS3

EN ISO 17632-A-T 42 Z Z W N 3

## Applications

- Heavy equipment
- Machinery

## Features

- High deposition rate
- Good crack resistance
- Good porosity resistance

## Welding Position



1G 2F  
(PA) (PB)

## Current

DC +

## Shielding Gas

No shielding gas

## Diameter / Packaging

Diameter	Spool	Coil
mm (in)	12.5kg (28lbs)	25kg (55lbs)
2.0 (0.078 in)	✓	✓
2.4 (0.094 in)	✓	✓

## Typical Chemical Composition of All-Weld Metal (%)

C	Si	Mn	P	S	Al
0.19	0.38	0.4	0.012	0.010	1.25

## Typical Mechanical Properties of All-Weld Metal

YS MPa(lbs/in <sup>2</sup> )	TS MPa(lbs/in <sup>2</sup> )	EL (%)
465 (67,400)	610 (88,400)	24

## Typical Operating Procedures

Diameter, Polarity Shielding Gas	CTWD mm (in)	Wire Feed Speed m/min (in/min)	Voltage (volts)	Approx. Current (amps)	Deposition Rate kg/hr (lb/hr)	Efficiency (%)
<b>2.0mm (0.078 in) DC+</b>						
No shielding gas	50 (2)	5.1 (200)	29-31	260-300	1.6 (3.5)	81-84
		6.1 (240)	30-32	290-330	2.3 (5.1)	
		6.6 (260)	30-32	310-350	2.6 (5.7)	
		7.6 (300)	31-33	330-370	3.1 (6.8)	
<b>2.4mm (0.094 in) DC+</b>						
No shielding gas	76 (3)	2.8 (110)	28-30	230-270	2.0 (4.3)	80-85
		3.8 (150)	29-31	280-320	2.5 (5.5)	
		4.7 (185)	30-32	330-370	3.0 (6.6)	
		5.8 (230)	31-33	380-420	4.2 (9.2)	
		7.0 (275)	32-34	430-470	5.6 (12.3)	

# Supershield EG-72T

Type : Self-Shielded

## Conformances

AWS A5.26/ ASME SFA5.26 EG72T-1

## Applications

- Storage tank
- Pressure vessels

## Features

- Electro gas arc welding(EGW)
- Vertical-up, V-groove & Square Butt joint single pass EGW process

## Welding Position



3G  
(PF)

## Current

DC +

## Shielding Gas

No shielding gas

## Diameter / Packaging

Diameter	Coil
mm (in)	25kg (55lbs)
2.4 (3/32)	√

## Typical Chemical Composition of All-Weld Metal (%)

C	Si	Mn	P	S	Mo
0.05	0.35	1.45	0.008	0.009	0.25

## Typical Mechanical Properties of All-Weld Metal

YS MPa(lbs/in <sup>2</sup> )	TS MPa(lbs/in <sup>2</sup> )	EL (%)	Temp °C(°F)	CVN-Impact Value J (ft-lbs)
520 (75,400)	590 (85,600)	27	-30 (-20)	45 (33)

## Typical Operating Procedures

Diameter, Polarity Shielding Gas	CTWD mm (in)	Wire Feed Speed m/min (in/min)	Voltage (volts)	Approx. Current (amps)	Deposition Rate kg/hr (lb/hr)
2.4mm (3/32 in) DC+					
No shielding gas	38 (1.49)	6.4 (250)	34	380~450	10 (22.0)
		7.6 (300)	36	450~480	12 (26.5)
		8.9 (350)	38	480~550	15 (33.1)
		10.2 (400)	45	550~600	18 (39.7)

# Supershield EG-82T

Type : Self-Shielded

## Conformances

AWS A5.26/ ASME SFA5.26 EG82T-G

## Applications

- Storage tank
- Pressure vessels

## Features

- Electro gas arc welding (EGW)
- Vertical- up, V-groove & Square Butt joint single pass EGW process
- Good impact value at low-temperature

## Welding Position



3G  
(PF)

## Current

DC +

## Shielding Gas

No shielding gas

## Diameter / Packaging

Diameter	Coil
mm (in)	25kg (55lbs)
2.4 (3/32)	✓

## Typical Chemical Composition of All-Weld Metal (%)

C	Si	Mn	P	S	Mo	Ni
0.05	0.26	1.50	0.009	0.010	0.35	0.98

## Typical Mechanical Properties of All-Weld Metal

YS MPa(lbs/in <sup>2</sup> )	TS MPa(lbs/in <sup>2</sup> )	EL (%)	Temp °C(°F)	CVN-Impact Value J (ft.-lbs)
550 (80,000)	640 (92,900)	25	-40 (-40)	55 (41)

## Typical Operating Procedures

Diameter, Polarity Shielding Gas	CTWD mm (in)	Wire Feed Speed m/min (in/min)	Voltage (volts)	Approx. Current (amps)	Deposition Rate kg/hr (lb/hr)
2.4mm (3/32 in) DC+					
No shielding gas	38 (1.49)	6.4 (250)	34	380-450	10 (22.0)
		7.6 (300)	36	450-480	12 (26.5)
		8.9 (350)	38	480-550	15 (33.1)
		10.2 (400)	45	550-600	18 (39.7)

SMW

SAW

GMW

GTAW

FCW

Non-FERROUS

APPENDIX

# SW-410 Cored

Type : Rutile

## Conformances

AWS A5.22/ ASME SFA5.22 E410T1-1/-4

JIS Z3323 TS410-FB1

## Applications

- 410, 410S, 405 stainless steels
- Welding of ASTM CA6NM castings

## Features

- Weld metal of martensite stainless steel
- Good hardness and anti-abrasion properties

## Welding Position



1G (PA) 2F (PB) 3G (PF) 4G (PE)

## Current

DC +

## Shielding Gas

100% CO<sub>2</sub>

Ar + 20~25% CO<sub>2</sub>

## Diameter / Packaging

Diameter	Spool			Pac		
	5kg (11lbs)	12.5kg (27.6lbs)	15kg (33lbs)	250kg (551lbs)	300kg (661lbs)	350kg (771lbs)
0.8 (0.033)						
0.9 (0.035)						
1.0 (0.040)						
1.2 (0.045)		√	√			
1.4 (0.052)						
1.6 (1/16)		√	√			

**Typical Chemical Composition of All-Weld Metal (%)**

	C	Si	Mn	P	S	Cr	Ni	Mo	Cu
100% CO <sub>2</sub>	0.07	0.5	0.4	0.008	0.01	12.5	0.4	0.01	0.03
80% Ar + 20% CO <sub>2</sub>	0.06	0.5	0.4	0.008	0.008	12.5	0.4	0.01	0.03

**Typical Mechanical Properties of All-Weld Metal**

	TS MPa(lbs/in <sup>2</sup> )	EL (%)	Temp °C(°F)	CVN-Impact Value J (ft-lbs)	Heat Treatment
100% CO <sub>2</sub>	610 (88,500)	23	0 (32)	14 (10)	750°C X 1hr
80% Ar + 20% CO <sub>2</sub>	600 (87,000)	23	0 (32)	13 (9)	

**Typical Operating Procedures**

Diameter, Polarity Shielding Gas	CTWD mm (in)	Wire Feed Speed m/min (in/min)	Voltage (volts)	Approx. Current (amps)	Deposition Rate kg/hr (lb/hr)
<b>1.2mm (0.045 in) DC+</b>					
100% CO <sub>2</sub>	20 (0.78)	12.7 (500)	29-31	260	1.3 (2.86)
		16 (628)	30-32	280	1.5 (3.30)
		16.5 (648)	31-33	300	1.8 (3.96)
<b>1.6mm (1/16 in) DC+</b>					
80% Ar + 20% CO <sub>2</sub>	20 (0.78)	7.6 (300)	31-33	300	1.7 (3.74)
		8.0 (314)	32-34	320	2.0 (4.40)
		8.9 (350)	32-34	340	2.3 (5.07)

SWAW

SAW

GMAW

GTAW

FCAW

Non-FERROUS

APPENDIX

# SW-307NS Cored

Type : Rutile

## Conformances

EN ISO 17633-A-T 18 8 Mn M M

## Applications

- Joining and overlay applications on 13Mn steels
- Cladding Carbon steels
- Welding of dissimilar steels (high Mn to carbon steel)

## Features

- Flat and horizontal fillet position welding
- High deposition rate and efficiency

## Welding Position



1G 2F  
(PA) (PB)

## Current

DC +

## Shielding Gas

Ar + 2% O<sub>2</sub>

## Diameter / Packaging

Diameter mm (in)	Spool			Pac		
	5kg (11lbs)	12.5kg (27.6lbs)	15kg (33lbs)	250kg (551lbs)	300kg (661lbs)	350kg (771lbs)
1.2 (0.045)		✓	✓	✓	✓	✓
1.6 (1/16)		✓	✓	✓	✓	✓

## Typical Chemical Composition of All-Weld Metal (%)

C	Si	Mn	P	S	Cr	Ni	Mo
0.07	0.6	7.3	0.021	0.008	18.3	8.6	0.1

## Typical Mechanical Properties of All-Weld Metal

TS MPa(lbs/in <sup>2</sup> )	EL (%)	Temp °C(°F)	CVN-Impact Value J (ft-lbs)
610 (88,500)	23	-20 (-4)	106 (78)
		-60 (-76)	71 (52)

## Typical Operating Procedures

Diameter, Polarity Shielding Gas	CTWD mm (in)	Wire Feed Speed m/min (in/min)	Voltage (volts)	Approx. Current (amps)	Deposition Rate kg/hr (lb/hr)
<b>1.2mm (0.045 in) DC+</b>					
Ar + 2% O <sub>2</sub>	20 (0.78)	5.5 (216)	23-25	190	4.2 (9.1)
		6.6 (260)	25-27	220	5 (10.9)
		8.1 (320)	26-28	250	6 (13.0)



# SW-308L Cored

Type : Rutile



## Conformances

AWS A5.22/ ASME SFA5.22 E308LT1-1/-4  
 JIS Z3323 TS308L-FB1  
 EN ISO 17633-A-T 199 L P M/C 2  
 ABS AWS A5.22 E308LT1-1 (-120°C 29J)  
 LR 304L (-120°C)  
 BV UP (KV -120°C)  
 DNV 308L (-120°C)

NK KW308LG(C)  
 TÜV EN ISO 17633-A - T 199 L P M21/C12  
 CWB AWS A5.22 E308LT1-1/4  
 CE  
 DB DIN EN ISO 17633-A-T 199 L P M/C 2  
 RS A-5(304L) (C1)

## Applications

- 18%Cr-8%Ni stainless steel

## Features

- Good porosity resistance
- Good performance in all positions

## Welding Position

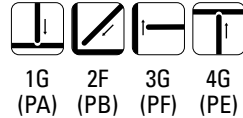

## Current

DC +

## Shielding Gas

100% CO<sub>2</sub>  
 Ar + 20~25% CO<sub>2</sub>

## Diameter / Packaging

Diameter mm (in)	Spool			Pac		
	5kg (11lbs)	12.5kg (27.6lbs)	15kg (33lbs)	250kg (551lbs)	300kg (661lbs)	350kg (771lbs)
0.9 (0.035)	✓	✓	✓			
1.0 (0.040)	✓	✓	✓			
1.2 (0.045)	✓	✓	✓			
1.4 (0.052)	✓	✓	✓			
1.6 (1/16)		✓	✓			

SMW

SAW

GMAW

GTAW

FCAW

Non-FERROUS

APPENDIX

**Typical Chemical Composition of All-Weld Metal (%)**

	C	Si	Mn	P	S	Cr	Ni	Mo
100% CO <sub>2</sub>	0.03	0.70	1.40	0.02	0.01	19.0	9.6	0.05
80% Ar + 20% CO <sub>2</sub>	0.03	0.80	1.50	0.02	0.01	19.5	9.7	0.05

**Typical Mechanical Properties of All-Weld Metal**

	TS MPa(lbs/in <sup>2</sup> )	EL (%)	Temp °C(°F)	CVN-Impact Value J (ft.-lbs)	Ferrite Number
100% CO <sub>2</sub>	550 (79,750)	44	-20 (4)	60 (44)	8-11
80% Ar + 20% CO <sub>2</sub>	560 (81,200)	43	-20 (4)	50 (37)	8-11

**Typical Operating Procedures**

Diameter, Polarity Shielding Gas	CTWD mm (in)	Wire Feed Speed m/min (in/min)	Voltage (volts)	Approx. Current (amps)	Deposition Rate kg/hr (lb/hr)
<b>1.2mm (0.045 in) DC+</b>					
100% CO <sub>2</sub>	20 (4/5)	6.2 (244)	23-26	140	2.6 (5.7)
		9.0 (354)	27-30	180	3.8 (8.4)
		12.0 (472)	28-31	210	4.6 (10.1)
80% Ar + 20% CO <sub>2</sub>	20 (4/5)	6.2 (244)	23-26	140	2.7 (5.9)
		9.0 (354)	27-30	180	3.7 (8.3)
		12.0 (472)	27-30	210	4.8 (10.6)
<b>1.6mm (1/16 in) DC+</b>					
100% CO <sub>2</sub>	25 (1)	3.7 (146)	24-27	180	3.0 (6.6)
		6.4 (250)	25-28	250	4.5 (9.9)
		8.9 (350)	26-29	290	5.5 (12.1)
80% Ar + 20% CO <sub>2</sub>	25 (1)	3.7 (146)	24-27	180	3.1 (6.8)
		6.4 (250)	25-28	250	4.6 (10.1)
		8.9 (350)	26-29	290	5.7 (12.6)

# SW-308LT

Type : Rutile

## Conformances

AWS A5.22/ ASME SFA5.22 E308LT1-1/-4

JIS Z3323 TS308L-FB1

EN ISO 17633-A-T 199 L P M/C 2

ABS AWS A5.22 E308LT1-1  
(-196°C ≥27 J)

## Applications

- Cryogenic service such as LNG storage tank
- 18% Cr-8%Ni stainless steels

## Features

- Good impact value at cryogenic temperatures
- Good performance in all positions

## Welding Position



1G 2F 3G 4G  
(PA) (PB) (PF) (PE)

## Current

DC +

## Shielding Gas

100% CO<sub>2</sub>  
Ar + 20~25% CO<sub>2</sub>

## Diameter / Packaging

Diameter	Spool			Pac		
	5kg (11lbs)	12.5kg (27.6lbs)	15kg (33lbs)	250kg (551lbs)	300kg (661lbs)	350kg (771lbs)
mm (in)						
1.2 (0.045)	√	√	√			

SWAW

SAW

GMAW

GTAW

FCAW

Non-FERROUS

APPENDIX

**Typical Chemical Composition of All-Weld Metal (%)**

	C	Si	Mn	P	S	Cr	Ni	Mo
100% CO <sub>2</sub>	0.03	0.50	1.50	0.02	0.01	18.5	9.9	0.05
80% Ar + 20% CO <sub>2</sub>	0.03	0.59	1.60	0.02	0.01	19.0	10.0	0.05

**Typical Mechanical Properties of All-Weld Metal**

	TS MPa(lbs/in <sup>2</sup> )	EL (%)	Temp °C(°F)	CVN-Impact Value J (ft.-lbs)	Ferrite Number
100% CO <sub>2</sub>	540 (78,300)	48	-196 (-321)	35 (26)	4-6
80% Ar + 20% CO <sub>2</sub>	550 (79,750)	49	-196 (-321)	35 (26)	4-6

**Typical Operating Procedures**

Diameter, Polarity Shielding Gas	CTWD mm (in)	Wire Feed Speed m/min (in/min)	Voltage (volts)	Approx. Current (amps)	Deposition Rate kg/hr (lb/hr)
<b>1.2mm (0.045 in) DC+</b>					
100% CO <sub>2</sub>	20 (4/5)	6.2 (244)	23-26	140	2.6 (5.7)
		9.2 (362)	27-30	180	3.5 (7.7)
		12.2 (480)	28-31	210	4.8 (10.6)
80% Ar + 20% CO <sub>2</sub>	20 (4/5)	6.2 (244)	23-26	140	2.6 (5.7)
		9.0 (354)	27-30	180	3.6 (7.9)
		12.0 (472)	27-30	210	4.9 (10.8)

# SW-309L Cored

Type : Rutile



## Conformances

AWS A5.22/ ASME SFA5.22 E309LT1-1/-4  
 JIS Z3323 TS309L-FB1  
 EN ISO 17633-A-T 23 12 L P M/C 2  
 KR RW309LG (C) (-20°C ≥34J)  
 ABS AWS A5.22 E309LT1-1  
 LR SS/CMn  
 BV 309L with KV at -20°C (-20°C ≥34J)  
 DNV 309L

GL 4332S  
 NK KW309LG(C)  
 TÜV EN ISO 17633-A - T23 12 L P M21/C12  
 CWB AWS A5.22 E309LT1-1/4  
 CE  
 DB DIN EN ISO 17633-A-T23 12 L P M/C2  
 RS A-9sp(309) (C1)

## Applications

- 23.5%Cr-13%Ni stainless steels
- Dissimilar welds between carbon, low alloy steels to stainless steels
- Buffer layer welding for cladding, overlays

## Features

- Good performance in all positions

## Welding Position



1G 2F 3G 4G  
 (PA) (PB) (PF) (PE)

## Current

DC +

## Shielding Gas

100% CO<sub>2</sub>  
 Ar + 20~25% CO<sub>2</sub>

## Diameter / Packaging

Diameter	Spool			Pac		
	5kg (11lbs)	12.5kg (27.6lbs)	15kg (33lbs)	250kg (551lbs)	300kg (661lbs)	350kg (771lbs)
0.9 (0.035)	✓	✓	✓			
1.0 (0.040)	✓	✓	✓			
1.2 (0.045)	✓	✓	✓			
1.4 (0.052)	✓	✓	✓			
1.6 (1/16)		✓	✓			

SWAW

SAW

GMAW

GTAW

FCAW

Non-FERROUS

APPENDIX

**Typical Chemical Composition of All-Weld Metal (%)**

	C	Si	Mn	P	S	Cr	Ni	Mo
100% CO <sub>2</sub>	0.03	0.75	1.20	0.02	0.01	22.8	12.3	0.05
80% Ar + 20% CO <sub>2</sub>	0.03	0.80	1.30	0.02	0.01	23.0	12.5	0.05

**Typical Mechanical Properties of All-Weld Metal**

	TS MPa(lbs/in <sup>2</sup> )	EL (%)	Temp °C(°F)	CVN-Impact Value J (ft.-lbs)	Ferrite Number
100% CO <sub>2</sub>	560 (81,200)	40	-20 (4)	50 (37)	16-19
80% Ar + 20% CO <sub>2</sub>	580 (84,100)	39	-20 (4)	45 (33)	16-19

**Typical Operating Procedures**

Diameter, Polarity Shielding Gas	CTWD mm (in)	Wire Feed Speed m/min (in/min)	Voltage (volts)	Approx. Current (amps)	Deposition Rate kg/hr (lb/hr)
<b>1.2mm (0.045 in) DC+</b>					
100% CO <sub>2</sub>	20 (4/5)	6.3 (248)	23-26	140	2.6 (5.7)
		9.0 (354)	27-30	180	3.7 (8.2)
		12.2 (480)	28-31	210	4.7 (10.4)
80% Ar + 20% CO <sub>2</sub>	20 (4/5)	6.2 (244)	23-26	140	2.8 (6.2)
		9.0 (354)	27-30	180	3.8 (8.4)
		12.0 (472)	27-30	210	4.9 (10.8)
<b>1.6mm (1/16 in) DC+</b>					
100% CO <sub>2</sub>	25 (1)	3.7 (146)	24-27	180	3.0 (6.6)
		6.4 (252)	25-28	250	4.6 (10.1)
		8.8 (346)	26-29	290	5.7 (12.6)
80% Ar + 20% CO <sub>2</sub>	25 (1)	3.7 (146)	24-27	180	3.2 (7.1)
		6.3 (248)	25-28	250	4.7 (10.4)
		8.8 (346)	26-29	290	5.9 (13.0)

# SW-309LNS Cored

Type : Metal-Cored

## Conformances

AWS A5.9/ ASME SFA5.9 EC309L  
 JIS Z3323 TS309L-MA0  
 EN ISO 17633-A-T 23 12 L M M

## Applications

- Automotive mufflers
- Welding of dissimilar metals such as stainless and carbon a low alloy steels

## Features

- Non-slag type
- Low spatter

## Welding Position



1G 2F  
(PA) (PB)

## Current

DC +

## Shielding Gas

Ar + 2% O<sub>2</sub>

## Diameter / Packaging

Diameter mm (in)	Spool			Pac		
	5kg (11lbs)	12.5kg (27.6lbs)	15kg (33lbs)	250kg (551lbs)	300kg (661lbs)	350kg (771lbs)
1.2 (0.045)		✓	✓	✓	✓	✓
1.6 (1/16)		✓	✓	✓	✓	✓

## Typical Chemical Composition of All-Weld Metal (%)

C	Si	Mn	P	S	Cr	Ni	Mo	Cu
0.025	0.5	1.8	0.02	0.01	24.0	13.0	0.13	0.12

## Typical Mechanical Properties of All-Weld Metal

TS MPa(lbs/in <sup>2</sup> )	EL (%)	Temp °C(°F)	CVN-Impact Value J (ft.-lbs)
590 (85,600)	45	-20 (-4)	60 (44)

## Typical Operating Procedures

Diameter, Polarity Shielding Gas	CTWD mm (in)	Wire Feed Speed m/min (in/min)	Voltage (volts)	Approx. Current (amps)	Deposition Rate kg/hr (lb/hr)
1.2mm (0.045 in) DC+					
Ar + 2% O <sub>2</sub>	20 (0.78)	5.5 (216)	23-25	190	4.2 (9.1)
		6.6 (260)	25-27	220	5 (10.9)
		8.1 (320)	26-28	250	6 (13.0)

# SW-309MoL Cored

Type : Rutile

## Conformances

AWS A5.22/ ASME SFA5.22 E309LMoT1-1/-4  
JIS Z3323 TS309LMo-FB1  
EN ISO 17633-A-T 23 12 2 L P M/C 2  
CWB AWS A5.22 E309LMoT1-1

DNV 309MoL (-20°C)  
GL 4459S  
NK KW309MoLG(C)

## Applications

- 22%Cr-12%Ni-2.5%Mo stainless steels
- Dissimilar welds between carbon, low alloy steels to stainless steels
- Buffer layer welding for cladding, overlays

## Features

- Good performance in all positions

## Welding Position

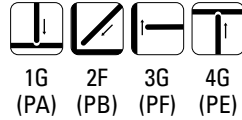

## Current

DC +

## Shielding Gas

100% CO<sub>2</sub>  
Ar + 20~25% CO<sub>2</sub>

## Diameter / Packaging

Diameter mm (in)	Spool			Pac		
	5kg (11lbs)	12.5kg (27.6lbs)	15kg (33lbs)	250kg (551lbs)	300kg (661lbs)	350kg (771lbs)
0.9 (0.035)	✓	✓	✓			
1.0 (0.040)	✓	✓	✓			
1.2 (0.045)	✓	✓	✓			
1.4 (0.052)	✓	✓	✓			
1.6 (1/16)		✓	✓			



**Typical Chemical Composition of All-Weld Metal (%)**

	C	Si	Mn	P	S	Cr	Ni	Mo
100% CO <sub>2</sub>	0.03	0.60	1.40	0.02	0.01	22.3	12.3	2.3
80% Ar + 20% CO <sub>2</sub>	0.03	0.70	1.50	0.02	0.01	23.5	12.5	2.4

**Typical Mechanical Properties of All-Weld Metal**

	TS MPa(lbs/in <sup>2</sup> )	EL (%)	Temp °C(°F)	CVN-Impact Value J (ft-lbs)	Ferrite Number
100% CO <sub>2</sub>	680 (98,600)	31	-20 (4)	45 (33)	17-20
80% Ar + 20% CO <sub>2</sub>	690 (100,050)	32	-20 (4)	50 (37)	17-20

**Typical Operating Procedures**

Diameter, Polarity Shielding Gas	CTWD mm (in)	Wire Feed Speed m/min (in/min)	Voltage (volts)	Approx. Current (amps)	Deposition Rate kg/hr (lb/hr)
<b>1.2mm (0.045 in) DC+</b>					
100% CO <sub>2</sub>	20 (4/5)	6.0 (236)	23-26	140	2.5 (5.5)
		9.0 (354)	27-30	180	3.6 (7.9)
		12.0 (472)	28-31	210	4.6 (10.1)
80% Ar + 20% CO <sub>2</sub>	20 (4/5)	6.2 (244)	23-26	140	2.6 (5.7)
		9.1 (358)	27-30	180	3.6 (7.9)
		12.0 (472)	27-30	210	4.7 (10.4)
<b>1.6mm (1/16 in) DC+</b>					
100% CO <sub>2</sub>	25 (1)	3.8 (150)	24-27	180	2.9 (6.4)
		6.2 (244)	25-28	250	4.4 (10.1)
		8.8 (346)	26-29	290	5.6 (12.3)
80% Ar + 20% CO <sub>2</sub>	25 (1)	3.6 (142)	24-27	180	3.1 (6.8)
		6.3 (248)	25-28	250	4.5 (9.9)
		8.7 (343)	26-29	290	5.5 (12.1)

SWAW

SAW

GMAW

GTAW

FCAW

Non-FERROUS

APPENDIX

# SW-316L Cored

Type : Rutile



## Conformances

AWS A5.22/ ASME SFA5.22 E316LT1-1/-4

JIS Z3323 TS316L-FB1

EN ISO 17633-A-T 19 12 3 L P M/C 2

KR RW316LG (C) (-60°C ≥34J)

ABS AWS A5.22 E316LT1-1/-4

TÜV EN ISO 17633-A - T 19 12 3 L P M21/C1 2

DB DIN EN ISO 17633-A-T 19 12 3 L P M/C 2

LR 316L

BV 316L (-60°C)

DNV 316L

GL 4435S

NK KW316LG(C)

CWB AWS A5.22 E316LT1-1/-4

CE

RS A-6(316L) (C1)

## Applications

- 18%Cr-12%Ni-2%Mo stainless steels

## Features

- Good performance in all positions

## Welding Position



1G 2F 3G 4G  
(PA) (PB) (PF) (PE)

## Current

DC +

## Shielding Gas

100% CO<sub>2</sub>

Ar + 20~25% CO<sub>2</sub>

## Diameter / Packaging

Diameter mm (in)	Spool			Pac		
	5kg (11lbs)	12.5kg (27.6lbs)	15kg (33lbs)	250kg (551lbs)	300kg (661lbs)	350kg (771lbs)
0.9 (0.035)	✓	✓	✓			
1.0 (0.040)	✓	✓	✓			
1.2 (0.045)	✓	✓	✓			
1.4 (0.052)	✓	✓	✓			
1.6 (1/16)		✓	✓			

**Typical Chemical Composition of All-Weld Metal (%)**

	C	Si	Mn	P	S	Cr	Ni	Mo
100% CO <sub>2</sub>	0.03	0.75	1.20	0.02	0.01	17.5	11.8	2.7
80% Ar + 20% CO <sub>2</sub>	0.03	0.80	1.30	0.02	0.01	18.0	12.0	2.8

**Typical Mechanical Properties of All-Weld Metal**

	TS MPa(lbs/in <sup>2</sup> )	EL (%)	Temp °C(°F)	CVN-Impact Value J (ft-lbs)	Ferrite Number
100% CO <sub>2</sub>	560 (81,200)	42	-20 (4)	45 (33)	8-9
80% Ar + 20% CO <sub>2</sub>	570 (82,650)	41	-20 (4)	40 (30)	8-9

**Typical Operating Procedures**

Diameter, Polarity Shielding Gas	CTWD mm (in)	Wire Feed Speed m/min (in/min)	Voltage (volts)	Approx. Current (amps)	Deposition Rate kg/hr (lb/hr)
<b>1.2mm (0.045 in) DC+</b>					
100% CO <sub>2</sub>	20 (4/5)	6.0 (236)	23-26	140	2.5 (5.5)
		9.2 (362)	27-30	180	3.4 (7.5)
		12.0 (472)	28-31	210	4.5 (9.9)
80% Ar + 20% CO <sub>2</sub>	20 (4/5)	6.1 (240)	23-26	140	2.6 (5.7)
		9.0 (354)	27-30	180	3.6 (7.9)
		11.5 (453)	27-30	210	4.6 (10.1)
<b>1.6mm (1/16 in) DC+</b>					
100% CO <sub>2</sub>	25 (1)	3.8 (150)	24-27	180	3.0 (6.6)
		6.5 (256)	25-28	250	4.6 (10.1)
		8.9 (350)	26-29	290	5.9 (13.0)
80% Ar + 20% CO <sub>2</sub>	25 (1)	3.7 (146)	24-27	180	3.1 (6.8)
		6.4 (250)	25-28	250	4.8 (10.6)
		8.8 (346)	26-29	290	6.1 (13.4)

SWAW

SAW

GMAW

GTAW

FCAW

Non-FERROUS

APPENDIX

# SW-316LT

Type : Rutile

## Conformances

AWS A5.22/ ASME SFA5.22 E316LT1-1/-4

JIS Z3323 TS316L-FB1

EN ISO 17633-A-T 19 12 3 L P M/C 2

## Applications

- Cryogenic service such as LNG storage tank
- 18% Cr-12%Ni-2%Mo stainless steels

## Features

- Good impact value at cryogenic temperature
- Good performance in all position

## Welding Position



1G 2F 3G 4G  
(PA) (PB) (PF) (PE)

## Current

DC +

## Shielding Gas

100% CO<sub>2</sub>

Ar + 20~25% CO<sub>2</sub>

## Diameter / Packaging

Diameter	Spool			Pac		
	5kg (11lbs)	12.5kg (27.6lbs)	15kg (33lbs)	250kg (551lbs)	300kg (661lbs)	350kg (771lbs)
mm (in)						
1.2 (0.045)	✓	✓	✓			

**Typical Chemical Composition of All-Weld Metal (%)**

	C	Si	Mn	P	S	Cr	Ni	Mo
100% CO <sub>2</sub>	0.03	0.60	1.60	0.02	0.01	17.5	12.0	2.2
80% Ar + 20% CO <sub>2</sub>	0.03	0.70	1.80	0.02	0.01	17.8	12.2	2.3

**Typical Mechanical Properties of All-Weld Metal**

	TS MPa(lbs/in <sup>2</sup> )	EL (%)	Temp °C(°F)	CVN-Impact Value J (ft-lbs)	Ferrite Number
100% CO <sub>2</sub>	540 (78,300)	40	-196 (-321)	35 (26)	4-5
80% Ar + 20% CO <sub>2</sub>	545 (79,025)	42	-196 (-321)	35 (26)	4-5

**Typical Operating Procedures**

Diameter, Polarity Shielding Gas	CTWD mm (in)	Wire Feed Speed m/min (in/min)	Voltage (volts)	Approx. Current (amps)	Deposition Rate kg/hr (lb/hr)
<b>1.2mm (0.045 in) DC+</b>					
100% CO <sub>2</sub>	20 (4/5)	6.0 (236)	23-26	140	2.6 (5.7)
		9.1 (358)	27-30	180	3.5 (7.7)
		12.2 (480)	28-31	210	4.6 (10.1)
80% Ar + 20% CO <sub>2</sub>	20 (4/5)	6.0 (236)	23-26	140	2.6 (5.7)
		9.0 (354)	27-30	180	3.6 (7.9)
		12.0 (472)	27-30	210	4.6 (10.1)

SWAW

SAW

GMAW

GTAW

FCAW

Non-FERROUS

APPENDIX

# SW-317L Cored

Type : Rutile

## Conformances

AWS A5.22/ ASME SFA5.22 E317LT1-1/-4

JIS Z3323 TS317L-FB1

## Applications

- 316, 317 type stainless steels

## Features

- Good performance in all positions

## Welding Position



1G (PA) 2F (PB) 3G (PF) 4G (PE)

## Current

DC +

## Shielding Gas

100% CO<sub>2</sub>

Ar + 20~25% CO<sub>2</sub>

## Diameter / Packaging

Diameter mm (in)	Spool			Pac		
	5kg (11lbs)	12.5kg (27.6lbs)	15kg (33lbs)	250kg (551lbs)	300kg (661lbs)	350kg (771lbs)
0.9 (0.035)	✓	✓	✓			
1.0 (0.040)	✓	✓	✓			
1.2 (0.045)	✓	✓	✓			
1.6 (1/16)		✓	✓			

**Typical Chemical Composition of All-Weld Metal (%)**

	C	Si	Mn	P	S	Cr	Ni	Mo
100% CO <sub>2</sub>	0.03	0.65	1.40	0.02	0.01	18.8	12.3	3.3
80% Ar + 20% CO <sub>2</sub>	0.03	0.70	1.50	0.02	0.01	19.0	12.3	3.4

**Typical Mechanical Properties of All-Weld Metal**

	TS MPa(lbs/in <sup>2</sup> )	EL (%)	Temp °C(°F)	CVN-Impact Value J (ft-lbs)	Ferrite Number
100% CO <sub>2</sub>	550 (79,750)	40	-20 (4)	45 (33)	9-10
80% Ar + 20% CO <sub>2</sub>	570 (82,707)	41	-20 (4)	45 (33)	9-10

**Typical Operating Procedures**

Diameter, Polarity Shielding Gas	CTWD mm (in)	Wire Feed Speed m/min (in/min)	Voltage (volts)	Approx. Current (amps)	Deposition Rate kg/hr (lb/hr)
<b>1.2mm (0.045 in) DC+</b>					
100% CO <sub>2</sub>	20 (4/5)	6.0 (236)	23-26	140	2.5 (5.5)
		8.9 (350)	27-30	180	3.4 (7.5)
		12.0 (472)	28-31	210	4.5 (9.9)
80% Ar + 20% CO <sub>2</sub>	20 (4/5)	6.0 (236)	23-26	140	2.6 (5.7)
		9.0 (354)	27-30	180	3.5 (7.7)
		11.5 (453)	27-30	210	4.5 (9.9)
<b>1.6mm (1/16 in) DC+</b>					
100% CO <sub>2</sub>	25 (1)	3.8 (150)	24-27	180	3.1 (6.8)
		6.5 (256)	25-28	250	4.6 (10.1)
		8.9 (350)	26-29	290	6.0 (13.2)
80% Ar + 20% CO <sub>2</sub>	25 (1)	3.7 (146)	24-27	180	3.2 (7.1)
		6.4 (250)	25-28	250	4.8 (10.6)
		9.0 (354)	26-29	290	6.2 (13.7)

SWAW

SAW

GMAW

GTAW

FCAW

Non-FERROUS

APPENDIX

# SW-347 Cored

Type : Rutile

## Conformances

AWS A5.22/ ASME SFA5.22 E347T1-1/-4

JIS Z3323 TS347-FB1

EN ISO 17633-A-T 19 9 Nb P M/C 2

## Applications

- Stainless steel boilers and gas turbine
- 347 and 321 type stainless steels

## Features

- Good performance in all positions

## Welding Position



1G 2F 3G 4G  
(PA) (PB) (PF) (PE)

## Current

DC +

## Shielding Gas

100% CO<sub>2</sub>

Ar + 20~25% CO<sub>2</sub>

## Diameter / Packaging

Diameter	Spool			Pac		
	5kg (11lbs)	12.5kg (27.6lbs)	15kg (33lbs)	250kg (551lbs)	300kg (661lbs)	350kg (771lbs)
0.9 (0.035)	✓	✓	✓			
1.2 (0.045)	✓	✓	✓			
1.6 (1/16)		✓	✓			



**Typical Chemical Composition of All-Weld Metal (%)**

	C	Si	Mn	P	S	Cr	Ni	Nb
100% CO <sub>2</sub>	0.04	0.60	1.40	0.02	0.01	19.3	9.9	0.40
80% Ar + 20% CO <sub>2</sub>	0.04	0.60	1.50	0.02	0.01	19.5	10.0	0.40

**Typical Mechanical Properties of All-Weld Metal**

	TS MPa(lbs/in <sup>2</sup> )	EL (%)	Temp °C(°F)	CVN-Impact Value J (ft-lbs)	Ferrite Number
100% CO <sub>2</sub>	610 (88,450)	38	-20 (4)	50 (37)	8-10
80% Ar + 20% CO <sub>2</sub>	620 (89,900)	37	-20 (4)	55 (41)	8-10

**Typical Operating Procedures**

Diameter, Polarity Shielding Gas	CTWD mm (in)	Wire Feed Speed m/min (in/min)	Voltage (volts)	Approx. Current (amps)	Deposition Rate kg/hr (lb/hr)
<b>1.2mm (0.045 in) DC+</b>					
100% CO <sub>2</sub>	20 (4/5)	6.5 (256)	23-26	140	2.6 (5.7)
		9.2 (362)	27-30	180	3.7 (8.2)
		12.5 (492)	28-31	210	4.8 (10.6)
80% Ar + 20% CO <sub>2</sub>	20 (4/5)	6.2 (244)	23-26	140	2.7 (6.0)
		9.0 (354)	27-30	180	3.7 (8.2)
		12.0 (472)	27-30	210	4.9 (10.8)
<b>1.6mm (1/16 in) DC+</b>					
100% CO <sub>2</sub>	25 (1)	3.8 (150)	24-27	180	3.2 (7.1)
		6.5 (256)	25-28	250	4.5 (9.9)
		9.0 (354)	26-29	290	5.6 (12.3)
80% Ar + 20% CO <sub>2</sub>	25 (1)	3.7 (146)	24-27	180	3.3 (7.3)
		6.4 (252)	25-28	250	4.8 (10.6)
		8.9 (350)	26-29	290	5.9 (13.0)

SWAW

SAW

GMAW

GTAW

FCAW

Non-FERROUS

APPENDIX

# SW-308HBF

Type : Rutile

## Conformances

AWS A5.22/ ASME SFA5.22 E308HT1-1-/4

## Applications

- Welding of 18%Cr-8%Ni stainless steels for high temperature service

## Features

- Designed for welding with 100% CO<sub>2</sub> or Ar+15~25%CO<sub>2</sub> shielding gas
- Excellent all position weldability
- Smooth and stable arc with a fast freezing slag

## Welding Position



1G 2F 3G 4G  
(PA) (PB) (PF) (PE)

## Current

DC +

## Shielding Gas

100% CO<sub>2</sub> / Ar+20~25% CO<sub>2</sub>

## Diameter / Packaging

Diameter mm (in)	Length mm(in)	
	12.5kg (28lbs)	15kg (33lbs)
1.2 (0.045)	√	√
1.4 (0.052)		
1.6 (1/16)		

## Typical Chemical Composition of All-Weld Metal(%)

C	Si	Mn	P	S	Cr	Ni	Mo	Cu	Fe
0.048	0.72	1.25	0.018	0.008	18.6	10.1	0.01	0.01	0.5

## Typical Mechanical Properties of All-Weld Metal

YS MPa(lbs/in <sup>2</sup> )	TS MPa(lbs/in <sup>2</sup> )	EL (%)	Temp °C(°F)	CVN-Impact Value J (ft-lbs)
-	580	41	-60 (-76)	50 (37)

## Typical Operating Procedures

Diameter, Polarity Shielding Gas	CTWD mm (in)	Wire Feed Speed m/min (in/min)	Voltage (volts)	Approx. Current (amps)	Deposition Rate kg/hr (lb/hr)
<b>1.2mm (0.045 in) DC+</b>					
100% CO <sub>2</sub>	20 (4/5)	6.0 (236)	23~26	140	2.5 (5.5)
		9.2 (362)	27~30	180	3.4 (7.5)
		12.0 (472)	28~31	210	4.5 (9.9)
80% Ar + 20% CO <sub>2</sub>	20 (4/5)	6.1 (240)	23~26	140	2.6 (5.7)
		9.0 (354)	27~30	180	3.6 (7.9)
		11.5 (453)	27~30	210	4.6 (10.1)

# SW-309HBF

Type : Rutile

## Conformances

AWS A5.22/ ASME SFA5.22 E309HT1-1-1/4

## Applications

- Welding of dissimilar metals such as stainless steel and carbon steel or stainless steel and low alloy

## Features

- Designed for welding with 100% CO<sub>2</sub> or Ar+15~25%CO<sub>2</sub> shielding gas
- Excellent all position weldability
- Smooth and stable arc with a fast freezing slag

## Welding Position



1G (PA) 2F (PB) 3G (PF) 4G (PE)

## Current

DC +

## Shielding Gas

100% CO<sub>2</sub> / Ar+20~25% CO<sub>2</sub>

## Diameter / Packaging

Diameter mm (in)	Length mm(in)	
	12.5kg (28lbs)	15kg (33lbs)
1.2 (0.045)	✓	✓
1.4 (0.052)		
1.6 (1/16)		

## Typical Chemical Composition of All-Weld Metal(%)

C	Si	Mn	P	S	Cr	Ni	Mo	Cu	Fe
0.05	0.72	1.3	0.018	0.008	22.6	12.8	0.01	0.01	0.5

## Typical Mechanical Properties of All-Weld Metal

YS MPa(lbs/in <sup>2</sup> )	TS MPa(lbs/in <sup>2</sup> )	EL (%)	Temp °C(°F)	CVN-Impact Value J (ft-lbs)
-	595	39	-60 (-76)	50 (37)

## Typical Operating Procedures

Diameter, Polarity Shielding Gas	CTWD mm (in)	Wire Feed Speed m/min (in/min)	Voltage (volts)	Approx. Current (amps)	Deposition Rate kg/hr (lb/hr)
<b>1.2mm (0.045 in) DC+</b>					
100% CO <sub>2</sub>	20 (4/5)	6.0 (236)	23~26	140	2.5 (5.5)
		9.2 (362)	27~30	180	3.4 (7.5)
		12.0 (472)	28~31	210	4.5 (9.9)
80% Ar + 20% CO <sub>2</sub>	20 (4/5)	6.1 (240)	23~26	140	2.6 (5.7)
		9.0 (354)	27~30	180	3.6 (7.9)
		11.5 (453)	27~30	210	4.6 (10.1)

# SW-316HBF

Type : Rutile

## Conformances

AWS A5.22/ ASME SFA5.22 E316HT1-1-/4

## Applications

- Welding of 18%Cr-12%Ni-2% Mo stainless steels for high temperature service.

## Features

- Designed for welding with 100% CO<sub>2</sub> or Ar+15~25%CO<sub>2</sub> shielding gas
- Excellent all position weldability
- Smooth and stable arc with a fast freezing slag

## Welding Position

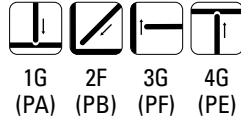

## Current

DC +

## Shielding Gas

100% CO<sub>2</sub>  
Ar + 20~25% CO<sub>2</sub>

## Diameter / Packaging

Diameter	Spool			Pac		
	12.5kg (28lbs)	15kg (33lbs)	20kg (44lbs)	250kg (551lbs)	300kg (661lbs)	350kg (771lbs)
1.2 (0.045)	✓	✓				
1.4 (0.052)						
1.6 (1/16)						

**Typical Chemical Composition of All-Weld Metal (%)**

C	Si	Mn	P	S	Cr	Ni	Mo	Cu	Fe
0.054	0.80	1.25	0.018	0.008	17.8	12.5	2.51	0.01	0.5

**Typical Mechanical Properties of All-Weld Metal**

YS MPa(lbs/in <sup>2</sup> )	TS MPa(lbs/in <sup>2</sup> )	EL (%)	Temp °C(°F)	CVN-Impact Value J (ft.-lbs)
-	565	40	-60 (-76)	56 (42)

**Typical Operating Procedures**

Diameter, Polarity Shielding Gas	CTWD mm (in)	Wire Feed Speed m/min (in/min)	Voltage (volts)	Approx. Current (amps)	Deposition Rate kg/hr (lb/hr)
<b>1.2mm (0.045 in) DC+</b>					
100% CO <sub>2</sub>	20 (4/5)	6.0 (236)	23~26	140	2.5 (5.5)
		9.2 (362)	27~30	180	3.4 (7.5)
		12.0 (472)	28~31	210	4.5 (9.9)
80% Ar + 20% CO <sub>2</sub>	20 (4/5)	6.1 (240)	23~26	140	2.6 (5.7)
		9.0 (354)	27~30	180	3.6 (7.9)
		11.5 (453)	27~30	210	4.6 (10.1)

SWAW

SAW

GMAW

GTAW

FCAW

Non-FERROUS

APPENDIX

# SW-410NiMo Cored

Type : Rutile

## Conformances

AWS A5.22/ ASME SFA5.22 E410NiMoT1-1/-4

JIS Z3323 TS410NiMo-FB1

EN ISO 17633-A-T 13 4 P M/C 2

## Applications

- Martensite stainless steels (ASTM, CA6NM)
- Hardfacing of continuous casting rolls, valve seat, etc
- Power plant

## Features

- Good performance in all positions

## Welding Position



1G 2F 3G 4G  
(PA) (PB) (PF) (PE)

## Current

DC +

## Shielding Gas

100% CO<sub>2</sub>

Ar + 20~25% CO<sub>2</sub>

## Diameter / Packaging

Diameter	Spool			Pac		
	5kg (11lbs)	12.5kg (27.6lbs)	15kg (33lbs)	250kg (551lbs)	300kg (661lbs)	350kg (771lbs)
1.2 (0.045)		✓	✓			
1.6 (1/16)		✓	✓			

**Typical Chemical Composition of All-Weld Metal (%)**

	C	Si	Mn	P	S	Cr	Ni	Mo
100% CO <sub>2</sub>	0.04	0.65	0.45	0.02	0.01	11.5	4.3	0.45
80% Ar + 20% CO <sub>2</sub>	0.04	0.70	0.50	0.02	0.01	11.5	4.5	0.50

**Typical Mechanical Properties of All-Weld Metal**

	TS MPa(lbs/in <sup>2</sup> )	EL (%)	Temp °C(°F)	CVN-Impact Value J (ft.-lbs)	Hardness (HRc)	PWHT
100% CO <sub>2</sub>	890 (129,050)	17	0 (32)	40 (30)	As weld : 37 PWHT : 26	600°C, 1hr, AC
80% Ar + 20% CO <sub>2</sub>	900 (130,500)	17	0 (32)	40 (30)	As weld : 37 PWHT : 27	600°C, 1hr, AC

**Typical Operating Procedures**

Diameter, Polarity Shielding Gas	CTWD mm (in)	Wire Feed Speed m/min (in/min)	Voltage (volts)	Approx. Current (amps)	Deposition Rate kg/hr (lb/hr)
<b>1.2mm (0.045 in) DC+</b>					
100% CO <sub>2</sub>	20 (4/5)	6.2 (244)	23-26	140	2.5 (5.5)
		9.0 (354)	27-30	180	3.6 (7.9)
		12.5 (492)	28-31	210	4.7 (10.4)
80% Ar + 20% CO <sub>2</sub>	20 (4/5)	6.2 (244)	23-26	140	2.6 (5.7)
		9.0 (354)	27-30	180	3.5 (7.7)
		12.0 (472)	27-30	210	4.8 (10.6)
<b>1.6mm (1/16 in) DC+</b>					
100% CO <sub>2</sub>	25 (1)	3.6 (142)	24-27	180	2.9 (6.4)
		6.5 (256)	25-28	250	4.6 (10.1)
		8.8 (346)	26-29	290	5.6 (12.3)
80% Ar + 20% CO <sub>2</sub>	25 (1)	3.7 (146)	24-27	180	3.0 (6.6)
		6.6 (260)	25-28	250	4.6 (10.1)
		8.9 (350)	26-29	290	5.8 (12.8)

SWAW

SAW

GMAW

GTAW

FCAW

Non-FERROUS

APPENDIX

# SW-2209 Cored

Type : Rutile

## Conformances

AWS A5.22/ ASME SFA5.22 E2209T1-1/-4

JIS Z3323 TS2209-FB1

EN ISO 17633-A-T 22 9 3 N L M/C 2

BV UP (KV -20°C ≥41 J)

DNV Duplex Stainless Steel

RS AF-8dup (M21)

## Applications

- Duplex stainless steel (NAS 329J3L, UNS S31803)

## Features

- Good performance in all positions

## Welding Position



1G 2F 3G 4G  
(PA) (PB) (PF) (PE)

## Current

DC +

## Shielding Gas

100% CO<sub>2</sub>

Ar + 20~25% CO<sub>2</sub>

## Diameter / Packaging

Diameter mm (in)	Spool			Pac		
	5kg (11lbs)	12.5kg (27.6lbs)	15kg (33lbs)	250kg (551lbs)	300kg (661lbs)	350kg (771lbs)
0.9 (0.035)	✓	✓	✓			
1.2 (0.045)	✓	✓	✓			
1.6 (1/16)		✓	✓			



Typical Chemical Composition of All-Weld Metal (%)

	C	Si	Mn	P	S	Cr	Ni	Mo	N	PREN
100% CO <sub>2</sub>	0.03	0.70	1.00	0.02	0.01	23.2	8.4	3.3	0.10	36
80% Ar + 20% CO <sub>2</sub>	0.03	0.80	1.10	0.02	0.01	23.5	8.5	3.3	0.10	36

Typical Mechanical Properties of All-Weld Metal

	TS MPa(lbs/in <sup>2</sup> )	EL (%)	Temp °C(°F)	CVN-Impact Value J (ft-lbs)	Ferrite Number
100% CO <sub>2</sub>	820 (118,900)	26	-20 (4) -50 (-58)	50 (37) 30 (22)	50-55
80% Ar + 20% CO <sub>2</sub>	840 (121,800)	25	-20 (4) -50 (-58)	55 (41) 30 (22)	50-55

Typical Operating Procedures

Diameter, Polarity Shielding Gas	CTWD mm (in)	Wire Feed Speed m/min (in/min)	Voltage (volts)	Approx. Current (amps)	Deposition Rate kg/hr (lb/hr)
<b>1.2mm (0.045 in) DC+</b>					
100% CO <sub>2</sub>	20 (4/5)	6.5 (256)	23-26	140	2.6 (5.7)
		9.8 (386)	27-30	180	3.8 (8.4)
		12.5 (492)	28-31	210	4.9 (10.8)
80% Ar + 20% CO <sub>2</sub>	20 (4/5)	6.5 (256)	23-26	140	2.8 (6.2)
		9.5 (374)	27-30	180	4.0 (8.8)
		12.0 (472)	27-30	210	5.0 (11.0)
<b>1.6mm (1/16 in) DC+</b>					
100% CO <sub>2</sub>	25 (1)	3.6 (142)	24-27	180	3.0 (6.6)
		6.5 (256)	25-28	250	4.5 (9.9)
		9.0 (354)	26-29	290	5.3 (11.7)
80% Ar + 20% CO <sub>2</sub>	25 (1)	3.5 (138)	24-27	180	3.2 (7.1)
		6.4 (252)	25-28	250	4.8 (10.6)
		8.9 (350)	26-29	290	5.5 (12.10)

SWAW

SAW

GMAW

GTAW

FCAW

Non-FERROUS

APPENDIX

# Supercored 308L

Type : Rutile



## Conformances

AWS A5.22/ ASME SFA5.22 E308LT0-1/-4  
 JIS Z3323 TS308L-FB0  
 EN ISO 17633-A-T 19 9 L R M/C 3  
 TÜV EN ISO 17633-A - T 19 9 L R M21/C1 3  
 DB DIN EN ISO 17633-A-T 19 9 L R M/C 3

CE

## Applications

- 18%Cr-8%Ni stainless steel

## Features

- Flat and horizontal fillet position welding
- High deposition rate and efficiency

## Welding Position



1G 2F  
 (PA) (PB)

## Current

DC +

## Shielding Gas

100% CO<sub>2</sub>  
 Ar + 20~25% CO<sub>2</sub>

## Diameter / Packaging

Diameter mm (in)	Spool			Pac		
	5kg (11lbs)	12.5kg (27.6lbs)	15kg (33lbs)	250kg (551lbs)	300kg (661lbs)	350kg (771lbs)
0.9 (0.035)	✓	✓	✓			
1.0 (0.040)	✓	✓	✓			
1.2 (0.045)	✓	✓	✓			
1.6 (1/16)		✓	✓			

**Typical Chemical Composition of All-Weld Metal (%)**

	C	Si	Mn	P	S	Cr	Ni	Mo
100% CO <sub>2</sub>	0.03	0.50	1.50	0.02	0.01	19.0	9.5	0.05
80% Ar + 20% CO <sub>2</sub>	0.03	0.60	1.60	0.02	0.01	19.5	9.6	0.05

**Typical Mechanical Properties of All-Weld Metal**

	TS MPa(lbs/in <sup>2</sup> )	EL (%)	Temp °C(°F)	CVN-Impact Value J (ft-lbs)	Ferrite Number
100% CO <sub>2</sub>	550 (79,750)	44	-20 (4)	50 (37)	7-10
80% Ar + 20% CO <sub>2</sub>	570 (82,650)	43	-20 (4)	55 (41)	7-10

**Typical Operating Procedures**

Diameter, Polarity Shielding Gas	CTWD mm (in)	Wire Feed Speed m/min (in/min)	Voltage (volts)	Approx. Current (amps)	Deposition Rate kg/hr (lb/hr)
<b>1.2mm (0.045 in) DC+</b>					
100% CO <sub>2</sub>	20 (4/5)	6.2 (244)	23-26	140	2.7 (6.0)
		9.0 (354)	27-30	180	3.9 (8.6)
		12.0 (472)	28-31	210	5.0 (11.0)
80% Ar + 20% CO <sub>2</sub>	20 (4/5)	6.2 (244)	23-26	140	2.8 (6.2)
		9.0 (354)	27-30	180	4.0 (8.8)
		12.0 (472)	27-30	210	5.1 (11.2)
<b>1.6mm (1/16 in) DC+</b>					
100% CO <sub>2</sub>	25 (1)	3.7 (146)	24-27	180	3.0 (6.6)
		6.4 (250)	25-28	250	4.8 (10.6)
		8.9 (350)	26-29	290	6.3 (13.9)
80% Ar + 20% CO <sub>2</sub>	25 (1)	3.7 (146)	24-27	180	3.1 (6.8)
		6.4 (250)	25-28	250	5.0 (11.0)
		8.9 (350)	26-29	290	6.5 (14.3)

SWAW

SAW

GMAW

GTAW

FCAW

Non-FERROUS

APPENDIX

# Supercored 309L

Type : Rutile



## Conformances

AWS A5.22/ ASME SFA5.22 E309LT0-1/-4  
 JIS Z3323 TS309L-FB0  
 EN ISO 17633-A-T 23 12 L R M/C 3  
 TÜV EN ISO 17633-A - T 23 12 L R M21/C1 3  
 DB DIN EN ISO 17633-A-T 23 12 L R M/C 3

CE  
 LR SS/CMn  
 BV 309L  
 DNV 309L (-20°C)  
 GL 4332S

## Applications

- 23.5%Cr-13%Ni stainless steels
- Dissimilar welds between carbon, low alloy steels to stainless steels
- Buffer layer welding for cladding, overlays

## Features

- Flat and horizontal fillet position welding
- High deposition rate and efficiency

## Welding Position



1G 2F  
 (PA) (PB)

## Current

DC +

## Shielding Gas

100% CO<sub>2</sub>  
 Ar + 20~25% CO<sub>2</sub>

## Diameter / Packaging

Diameter mm (in)	Spool			Pac		
	5kg (11lbs)	12.5kg (27.6lbs)	15kg (33lbs)	250kg (551lbs)	300kg (661lbs)	350kg (771lbs)
0.9 (0.035)	✓	✓	✓			
1.0 (0.040)	✓	✓	✓			
1.2 (0.045)	✓	✓	✓			
1.6 (1/16)		✓	✓			

## Typical Chemical Composition of All-Weld Metal (%)

	C	Si	Mn	P	S	Cr	Ni	Mo	Cu
100% CO <sub>2</sub>	0.033	0.50	1.61	0.020	0.006	22.5	12.37	0.12	0.12
80% Ar + 20% CO <sub>2</sub>	0.030	0.60	1.66	0.015	0.007	22.6	12.45	0.12	0.15

## Typical Mechanical Properties of All-Weld Metal

	TS MPa(lbs/in <sup>2</sup> )	EL (%)	Temp °C(°F)	CVN-Impact Value J (ft-lbs)	Ferrite Number
100% CO <sub>2</sub>	570 (82,650)	35	-20 (4)	45 (33)	18-20
80% Ar + 20% CO <sub>2</sub>	580 (84,100)	34	-20 (4)	40 (30)	18-20

## Typical Operating Procedures

Diameter, Polarity Shielding Gas	CTWD mm (in)	Wire Feed Speed m/min (in/min)	Voltage (volts)	Approx. Current (amps)	Deposition Rate kg/hr (lb/hr)
<b>1.2mm (0.045 in) DC+</b>					
100% CO <sub>2</sub>	20 (4/5)	6.2 (244)	23-26	140	2.6 (5.7)
		9.0 (354)	27-30	180	3.8 (8.4)
		12.0 (472)	28-31	210	5.0 (11.0)
80% Ar + 20% CO <sub>2</sub>	20 (4/5)	6.2 (244)	23-26	140	2.8 (6.2)
		9.5 (374)	27-30	180	4.1 (9.0)
		12.0 (472)	27-30	210	5.2 (11.5)
<b>1.6mm (1/16 in) DC+</b>					
100% CO <sub>2</sub>	25 (1)	3.7 (146)	24-27	180	3.3 (7.3)
		6.4 (250)	25-28	250	5.2 (11.5)
		8.9 (350)	26-29	290	6.6 (14.6)
80% Ar + 20% CO <sub>2</sub>	25 (1)	3.7 (146)	24-27	180	3.4 (7.5)
		6.4 (250)	25-28	250	5.4 (11.9)
		8.9 (350)	26-29	290	6.8 (15.0)

# Supercored 309MoL

Type : Rutile

## Conformances

AWS A5.22/ ASME SFA5.22 E309LMoT0-1/-4  
JIS Z3323 TS309LMo-FB0  
EN ISO 17633-A-T 23 12 2 L R M/C 3  
LR SS/CMn

BV 309LMo  
DNV 309MoL (-20°C)  
GL 4459S

## Applications

- 22%Cr-12%Ni-2.5%Mo stainless steels
- Dissimilar welds between carbon, low alloy steels to stainless steels
- Buffer layer welding for cladding, overlays

## Features

- Flat and horizontal fillet position welding
- High deposition rate and efficiency

## Welding Position



1G 2F  
(PA) (PB)

## Current

DC +

## Shielding Gas

100% CO<sub>2</sub>  
Ar + 20~25% CO<sub>2</sub>

## Diameter / Packaging

Diameter mm (in)	Spool			Pac		
	5kg (11lbs)	12.5kg (27.6lbs)	15kg (33lbs)	250kg (551lbs)	300kg (661lbs)	350kg (771lbs)
0.9 (0.035)	✓	✓	✓			
1.0 (0.040)	✓	✓	✓			
1.2 (0.045)	✓	✓	✓			
1.6 (1/16)		✓	✓			

**Typical Chemical Composition of All-Weld Metal (%)**

	C	Si	Mn	P	S	Cr	Ni	Mo
100% CO <sub>2</sub>	0.03	0.50	1.10	0.02	0.01	22.0	12.2	2.2
80% Ar + 20% CO <sub>2</sub>	0.03	0.60	1.20	0.02	0.01	22.5	12.5	2.3

**Typical Mechanical Properties of All-Weld Metal**

	TS MPa(lbs/in <sup>2</sup> )	EL (%)	Temp °C(°F)	CVN-Impact Value J (ft-lbs)	Ferrite Number
100% CO <sub>2</sub>	680 (98,600)	35	-20 (4)	50 (37)	17-20
80% Ar + 20% CO <sub>2</sub>	690 (100,050)	32	-20 (4)	55 (40)	17-20

**Typical Operating Procedures**

Diameter, Polarity Shielding Gas	CTWD mm (in)	Wire Feed Speed m/min (in/min)	Voltage (volts)	Approx. Current (amps)	Deposition Rate kg/hr (lb/hr)
<b>1.2mm (0.045 in) DC+</b>					
100% CO <sub>2</sub>	20 (4/5)	6.2 (244)	23-26	140	2.6 (5.7)
		9.1 (358)	27-30	180	3.9 (8.6)
		12.0 (472)	28-31	210	5.0 (11.0)
80% Ar + 20% CO <sub>2</sub>	20 (4/5)	6.2 (244)	23-26	140	2.8 (6.2)
		9.2 (362)	27-30	180	4.0 (8.8)
		12.0 (472)	27-30	210	5.1 (11.2)
<b>1.6mm (1/16 in) DC+</b>					
100% CO <sub>2</sub>	25 (1)	3.7 (146)	24-27	180	3.3 (7.3)
		6.4 (250)	25-28	250	5.3 (11.7)
		9.0 (354)	26-29	290	6.6 (14.6)
80% Ar + 20% CO <sub>2</sub>	25 (1)	3.6 (142)	24-27	180	3.2 (7.1)
		6.4 (250)	25-28	250	5.5 (12.1)
		9.0 (354)	26-29	290	6.7 (14.8)

SWAW

SAW

GMAW

GTAW

FCAW

Non-FERROUS

APPENDIX

# Supercored 316L

Type : Rutile



## Conformances

AWS A5.22/ ASME SFA5.22 E316LT0-1/-4  
JIS Z3323 TS316L-FB0  
EN ISO 17633-A-T 19 12 3 L R M/C 3  
TÜV EN ISO 17633-A - T 19 12 3 L R M21/C1 3  
DB DIN EN ISO 17633-A-T 19 12 3 L R M/C 3

CE  
LR 316L  
BV 316L  
DNV 316L (-20°C)  
GL 4435S

## Applications

- 18%Cr-12%Ni-2%Mo stainless steels

## Features

- Flat and horizontal fillet position welding
- High deposition rate and efficiency

## Welding Position



1G 2F  
(PA) (PB)

## Current

DC +

## Shielding Gas

100% CO<sub>2</sub>  
Ar + 20~25% CO<sub>2</sub>

## Diameter / Packaging

Diameter mm (in)	Spool			Pac		
	5kg (11lbs)	12.5kg (27.6lbs)	15kg (33lbs)	250kg (551lbs)	300kg (661lbs)	350kg (771lbs)
0.9 (0.035)	✓	✓	✓			
1.0 (0.040)	✓	✓	✓			
1.2 (0.045)	✓	✓	✓			
1.6 (1/16)		✓	✓			



**Typical Chemical Composition of All-Weld Metal (%)**

	C	Si	Mn	P	S	Cr	Ni	Mo
100% CO <sub>2</sub>	0.03	0.50	1.50	0.02	0.01	17.8	11.8	2.7
80% Ar + 20% CO <sub>2</sub>	0.03	0.60	1.60	0.02	0.01	18.0	12.0	2.8

**Typical Mechanical Properties of All-Weld Metal**

	TS MPa(lbs/in <sup>2</sup> )	EL (%)	Temp °C(°F)	CVN-Impact Value J (ft-lbs)	Ferrite Number
100% CO <sub>2</sub>	550 (79,750)	40	-20 (4)	50 (37)	8-10
80% Ar + 20% CO <sub>2</sub>	560 (81,200)	39	-20 (4)	45 (33)	8-10

**Typical Operating Procedures**

Diameter, Polarity Shielding Gas	CTWD mm (in)	Wire Feed Speed m/min (in/min)	Voltage (volts)	Approx. Current (amps)	Deposition Rate kg/hr (lb/hr)
<b>1.2mm (0.045 in) DC+</b>					
100% CO <sub>2</sub>	20 (4/5)	6.0 (236)	23-26	140	2.7 (5.9)
		9.2 (362)	27-30	180	3.6 (7.9)
		12.0 (472)	28-31	210	4.7 (10.4)
80% Ar + 20% CO <sub>2</sub>	20 (4/5)	6.1 (240)	23-26	140	2.7 (5.9)
		9.0 (354)	27-30	180	3.7 (8.2)
		11.5 (453)	27-30	210	4.8 (10.6)
<b>1.6mm (1/16 in) DC+</b>					
100% CO <sub>2</sub>	25 (1)	3.8 (150)	24-27	180	3.4 (7.5)
		6.5 (256)	25-28	250	4.9 (10.8)
		8.9 (350)	26-29	290	6.3 (13.9)
80% Ar + 20% CO <sub>2</sub>	25 (1)	3.7 (146)	24-27	180	3.5 (7.7)
		6.4 (250)	25-28	250	5.0 (11.0)
		8.8 (346)	26-29	290	6.4 (14.1)

SMW

SAW

GMAW

GTAW

FCAW

Non-FERROUS

APPENDIX

# SF-409Ti

Type : Metal-Cored

## Conformances

AWS A5.9/ ASME SFA5.9 EC409

JIS Z3323 TS409-MA0

## Applications

- Stainless steels 409 Type
- Automotive mufflers

## Features

- Good corrosion resistance
- Low spatter
- Non-slag type

## Welding Position



1G 2F  
(PA) (PB)

## Current

DC +

## Shielding Gas

Ar + 2% O<sub>2</sub>

## Diameter / Packaging

Diameter mm (in)	Spool			Pac		
	5kg (11lbs)	12.5kg (27.6lbs)	15kg (33lbs)	250kg (551lbs)	300kg (661lbs)	350kg (771lbs)
0.9 (0.035)		√	√	√	√	√
1.0 (0.040)		√	√	√	√	√
1.2 (0.045)		√	√	√	√	√
1.4 (0.052)		√	√	√	√	√

## Typical Chemical Composition of All-Weld Metal (%)

C	Si	Mn	P	S	Cr	Ti
0.03	0.50	0.55	0.012	0.010	12.5	1.0

## Typical Mechanical Properties of All-Weld Metal

TS MPa(lbs/in <sup>2</sup> )	EL (%)
500 (72,600)	20

## Typical Operating Procedures

Diameter, Polarity Shielding Gas	CTWD mm (in)	Wire Feed Speed m/min (in/min)	Voltage (volts)	Approx. Current (amps)	Deposition Rate kg/hr (lb/hr)
<b>1.2mm (0.045 in) DC+</b>					
Ar + 2% O <sub>2</sub>	20 (0.78)	5.5 (216)	23~25	180	2.9 (6.3)
		6.6 (260)	25~27	210	3.5 (7.6)
		8.1 (320)	26~28	250	4.4 (9.5)

# SF-430

Type : Metal-Cored

## Conformances

AWS A5.9/ ASME SFA5.9 EC430

JIS Z3323 TS430-MA0

## Applications

- Stainless steels 409 and 430 Type
- Automotive mufflers

## Features

- Good corrosion resistance
- Low spatter
- Non-slag type

## Welding Position



1G 2F  
(PA) (PB)

## Current

DC +

## Shielding Gas

Ar + 2% O<sub>2</sub>

## Diameter / Packaging

Diameter mm (in)	Spool			Pac		
	5kg (11lbs)	12.5kg (27.6lbs)	15kg (33lbs)	250kg (551lbs)	300kg (661lbs)	350kg (771lbs)
1.2 (0.045)		√	√	√	√	√

## Typical Chemical Composition of All-Weld Metal (%)

C	Si	Mn	P	S	Cr	Ti
0.03	0.30	0.50	0.005	0.010	16.5	0.45

## Typical Mechanical Properties of All-Weld Metal

TS MPa(lbs/in <sup>2</sup> )	EL (%)	Heat treatment
500 (72,600)	40	770°C x 4hr FC to 600°C AC to RT

## Typical Operating Procedures

Diameter, Polarity Shielding Gas	CTWD mm (in)	Wire Feed Speed m/min (in/min)	Voltage (volts)	Approx. Current (amps)	Deposition Rate kg/hr (lb/hr)
1.2mm (0.045 in) DC+					
Ar + 2% O <sub>2</sub>	20 (0.78)	5.5 (216)	23-25	180	3.0 (6.6)
		6.6 (260)	25-27	210	3.4 (7.4)
		8.1 (320)	26-28	250	4.3 (9.4)

# SF-430Nb

Type : Metal-Cored

## Conformances

JIS Z3323 TS430Nb-MA0

EN 12072 G Z 17 L Nb

## Applications

- Stainless steels 409 and 430 Type
- Automotive mufflers

## Features

- Good corrosion resistance
- Low spatter
- Non-slag type

## Diameter / Packaging

Diameter mm (in)	Spool			Pac		
	5kg (11lbs)	12.5kg (27.6lbs)	15kg (33lbs)	250kg (551lbs)	300kg (661lbs)	350kg (771lbs)
1.2 (0.045)		✓	✓	✓	✓	✓

## Typical Chemical Composition of All-Weld Metal (%)

C	Si	Mn	P	S	Cr	Nb	Ti
0.03	0.40	0.17	0.010	0.010	16.5	0.50	0.40

## Typical Mechanical Properties of All-Weld Metal

TS MPa(lbs/in <sup>2</sup> )	EL (%)
520 (75,400)	24

## Typical Operating Procedures

Diameter, Polarity Shielding Gas	CTWD mm (in)	Wire Feed Speed m/min (in/min)	Voltage (volts)	Approx. Current (amps)	Deposition Rate kg/hr (lb/hr)
1.2mm (0.045 in) DC+					
Ar + 2% O <sub>2</sub>	20 (0.78)	5.5 (216)	23~25	180	2.9 (6.3)
		6.6 (260)	25~27	210	3.4 (7.4)
		8.1 (320)	26~28	250	4.5 (9.9)

## Welding Position



1G 2F  
(PA) (PB)

## Current

DC +

## Shielding Gas

Ar + 2% O<sub>2</sub>

# SF-436

Type : Metal-Cored

## Conformances

## Applications

- Stainless steels 409, 430 and 436 Type
- Automotive mufflers

## Features

- Good corrosion resistance
- Low spatter
- Non-slag type

## Welding Position



1G 2F  
(PA) (PB)

## Current

DC +

## Shielding Gas

Ar + 2% O<sub>2</sub>

## Diameter / Packaging

Diameter	Spool			Pac		
	5kg (11lbs)	12.5kg (27.6lbs)	15kg (33lbs)	250kg (551lbs)	300kg (661lbs)	350kg (771lbs)
mm (in)						
1.2 (0.045)		✓	✓	✓	✓	✓

## Typical Chemical Composition of All-Weld Metal (%)

C	Si	Mn	P	S	Cr	Ni	Mo	Cu	Ti
0.03	0.4	0.5	0.008	0.006	16.8	0.04	0.78	0.02	0.5

## Typical Mechanical Properties of All-Weld Metal

TS MPa(lbs/in <sup>2</sup> )	EL (%)	Heat treatment
500 (72,600)	35	770°C x 4hr FC to 600°C AC to RT

## Typical Operating Procedures

Diameter, Polarity Shielding Gas	CTWD mm (in)	Wire Feed Speed m/min (in/min)	Voltage (volts)	Approx. Current (amps)	Deposition Rate kg/hr (lb/hr)
1.2mm (0.045 in) DC+					
Ar + 2% O <sub>2</sub>	20 (0.78)	5.5 (216)	23-25	180	2.8 (6.2)
		6.6 (260)	25-27	210	3.3 (7.3)
		8.1 (320)	26-28	250	4.5 (9.9)

# SC-439Ti Cored

Type : Metal-Cored

## Conformances

## Applications

- Stainless steels 409, 430, 436, 439 Type
- Automotive mufflers

## Features

- Good corrosion resistance
- Low spatter
- Non-slag type

## Welding Position



1G 2F  
(PA) (PB)

## Current

DC +

## Shielding Gas

Ar + 2% O<sub>2</sub>

## Diameter / Packaging

Diameter mm (in)	Spool			Pac		
	5kg (11lbs)	12.5kg (27.6lbs)	15kg (33lbs)	250kg (551lbs)	300kg (661lbs)	350kg (771lbs)
1.2 (0.045)		✓	✓	✓	✓	✓

## Typical Chemical Composition of All-Weld Metal (%)

C	Si	Mn	P	S	Cr	Ni	Ti
0.03	0.3	0.6	0.005	0.010	18.5	0.04	0.75

## Typical Mechanical Properties of All-Weld Metal

TS MPa(lbs/in <sup>2</sup> )	EL (%)	Heat treatment
500 (72,600)	40	770°C x 4hr FC to 600°C AC to RT

## Typical Operating Procedures

Diameter, Polarity Shielding Gas	CTWD mm (in)	Wire Feed Speed m/min (in/min)	Voltage (volts)	Approx. Current (amps)	Deposition Rate kg/hr (lb/hr)
1.2mm (0.045 in) DC+					
Ar + 2% O <sub>2</sub>	20 (0.78)	5.5 (216)	23~25	180	2.8 (6.2)
		6.6 (260)	25~27	210	3.3 (7.3)
		8.1 (320)	26~28	250	4.3 (9.4)

# Supershield CrC

Cr-Carbide Type

## Conformances

## Applications

- Cement roll mill, bucket teeth and lips, crusher and coke hammers, wear plate

## Features

- Open arc type hardfacing wire
- Cr-Carbide type

## Welding Position



1G  
(PA)

## Current

DC +

## Welding Process

Open Arc

## Diameter / Packaging

Diameter	Spool		Coil	Pac		
	12.5kg (27.6lbs)	15kg (33lbs)		150kg (330lbs)	250kg (551lbs)	350kg (771lbs)
1.2 (0.045)		✓				
1.6 (1/16)		✓				
2.4 (3/32)			✓	✓	✓	
2.8 (7/64)			✓	✓	✓	
3.2 (1/8)						

SMW

SAW

GMAW

GTAW

FCAW

Non-FERROUS

APPENDIX

### Typical Chemical Composition of All-Weld Metal (%)

	C	Si	Mn	P	S	Cr
As welded with 1.2/1.6mm wires	4.5	0.4	1.6	0.011	0.004	25.0
As welded with 2.4/2.8mm wires	5.2	0.6	1.4	0.013	0.005	28.5

### Typical Mechanical Properties of All-Weld Metal

		Rockwell Hardness(HRc)		
		1 Layer	2 Layers	4 Layers
On Mild Steel	1.2/1.6mm	42-46	50-54	54-58
	2.4/2.8mm	50-52	54-57	60-65

### Typical Operating Procedures

Diameter, Polarity Shielding Gas	CTWD mm (in)	Wire Feed Speed m/min (in/min)	Voltage (volts)	Approx. Current (amps)	Deposition Rate kg/hr (lb/hr)
<b>1.6mm (1/16 in) DC+</b>					
Open Arc	25 (1)	5.0 (196)	28	250	3.4 (7.4)
		7.5 (295)	29	300	5.3 (11.6)
		11.5 (452)	32	350	7.5 (16.6)
<b>2.8mm (7/64in), DC+</b>					
Open Arc	25 (1)	2.9 (117)	28	330	5.2 (11.4)
		3.7 (146)	29	380	6.4 (14.1)
		4.4 (174)	30	430	7.3 (16.0)



# Supershield CrCW

Cr-Carbide Type

## Conformances

## Applications

- Wear plate, conveyor screws, bucket teeth

## Features

- Open arc type hardfacing wire
- Cr-Carbide type

## Welding Position



1G  
(PA)

## Current

DC +

## Welding Process

Open Arc

## Diameter / Packaging

Diameter	Spool		Coil	Pac		
	12.5kg (27.6lbs)	15kg (33lbs)		150kg (330lbs)	250kg (551lbs)	350kg (771lbs)
1.2 (0.045)		✓				
1.6 (1/16)		✓				
2.4 (3/32)			✓	✓	✓	
2.8 (7/64)			✓	✓	✓	
3.2 (1/8)						

SMW

SAW

GMW

GTAW

FCAW

Non-FERROUS

APPENDIX

### Typical Chemical Composition of All-Weld Metal (%)

	C	Si	Mn	P	S	Cr
As welded with 1.2/1.6mm wires	4.5	0.6	0.7	0.011	0.006	25.0
As welded with 2.4/2.8mm wires	5.0	1.7	1.8	0.012	0.008	25.0

### Typical Mechanical Properties of All-Weld Metal

		Rockwell Hardness(HRc)		
		1 Layer	2 Layers	4 Layers
On Mild Steel	1.2/1.6mm	40~44	46~49	53~56
	2.4/2.8mm	48~52	52~58	58~63

### Typical Operating Procedures

Diameter, Polarity Shielding Gas	CTWD mm (in)	Wire Feed Speed m/min (in/min)	Voltage (volts)	Approx. Current (amps)	Deposition Rate kg/hr (lb/hr)
<b>1.6mm (1/16 in) DC+</b>					
Open Arc	25 (1)	5.0 (196)	28	250	3.4 (7.4)
		7.5 (295)	29	300	5.2 (11.4)
		11.5 (452)	32	350	7.4 (16.3)
<b>2.8mm (7/64in), DC+</b>					
Open Arc	25 (1)	2.9 (117)	28	330	5.2 (11.4)
		3.7 (146)	29	380	6.3 (13.9)
		4.4 (174)	30	430	7.2 (15.8)

# Supershield CrCH

Cr-Carbide Type

## Conformances

## Applications

- Wear plate, conveyor screws, bucket teeth

## Features

- Open arc type hardfacing wire
- Cr-Carbide type

## Welding Position



1G  
(PA)

## Current

DC +

## Welding Process

Open Arc

## Diameter / Packaging

Diameter	Coil			Pac	
	mm (in)	25kg (55lbs)	150kg (330lbs)	250kg (551lbs)	
2.8 (7/64)		✓	✓	✓	

## Typical Chemical Composition of All-Weld Metal (%)

	C	Si	Mn	P	S	Cr
As welded with 2.8mm wires	5.0	1.5	0.2	0.010	0.007	28.0

## Typical Mechanical Properties of All-Weld Metal

	Rockwell Hardness(HRC)		
	1 Layer	2 Layers	4 Layers
On Mild Steel (2.8mm)	55-59	60-62	62-65

## Typical Operating Procedures

Diameter, Polarity Shielding Gas	CTWD mm (in)	Wire Feed Speed m/min (in/min)	Voltage (volts)	Approx. Current (amps)	Deposition Rate kg/hr (lb/hr)
<b>2.8mm (7/64in), DC+</b>					
Open Arc	25 (1)	2.9 (117)	28	330	5.2 (11.4)
		3.7 (146)	29	380	6.4 (14.1)
		4.4 (174)	30	430	7.2 (15.8)

SMAW

SAW

GMAW

GTAW

FCAW

Non-FERROUS

APPENDIX

# Supershield CrCNb5

Cr-Carbide+Nb-Carbide Type

## Conformances

## Applications

- Cement roll mill, bucket teeth and lips, crusher and coke hammers, wear plate

## Features

- Open arc type hardfacing wire
- Cr-Carbide + Nb-Carbide type

## Welding Position



1G  
(PA)

## Current

DC +

## Welding Process

Open Arc

## Diameter / Packaging

Diameter mm (in)	Coil		Pac
	25kg (55lbs)	150kg (330lbs)	250kg (551lbs)
2.4 (3/32)	✓	✓	✓

## Typical Chemical Composition of All-Weld Metal (%)

	C	Si	Mn	P	S	Cr	Nb
As welded with 2.4mm wires	5.0	1.0	0.5	0.010	0.006	22.0	4.8

## Typical Mechanical Properties of All-Weld Metal

	Rockwell Hardness(HRc)		
	1 Layer	2 Layers	4 Layers
On Mild Steel (2.4mm)	-	-	62-64

## Typical Operating Procedures

Diameter, Polarity Shielding Gas	CTWD mm (in)	Wire Feed Speed m/min (in/min)	Voltage (volts)	Approx. Current (amps)	Deposition Rate kg/hr (lb/hr)
2.4mm (3/32in), DC+					
Open Arc	25 (1)	2.2 (85)	28	300	3.8 (8.3)
		2.7 (105)	29	340	5.5 (12.1)
		3.1 (124)	30	380	7.1 (15.6)

# Supershield CrCNb

Cr-Carbide+Nb-Carbide Type

## Conformances

## Applications

- Cement roll mill, bucket teeth and lips, crusher and coke hammers, wear plate

## Features

- Open arc type hardfacing wire
- Cr-Carbide + Nb-Carbide type

## Welding Position



1G  
(PA)

## Current

DC +

## Welding Process

Open Arc

## Diameter / Packaging

Diameter	Spool		Coil	Pac		
	12.5kg (27.6lbs)	15kg (33lbs)	25kg (55lbs)	150kg (330lbs)	250kg (551lbs)	350kg (771lbs)
1.2 (0.045)						
1.6 (1/16)		√				
2.4 (3/32)						
2.8 (7/64)			√	√	√	
3.2 (1/8)						

SM/W

SAW

GMAW

GTAW

FCAW

Non-FERROUS

APPENDIX

### Typical Chemical Composition of All-Weld Metal (%)

	C	Si	Mn	P	S	Cr	Nb
As welded with 1.6mm wires	4.5	0.8	0.2	0.015	0.003	21.0	6.0
As welded with 2.8mm wires	5.2	1.0	0.2	0.011	0.004	22.0	6.8

### Typical Mechanical Properties of All-Weld Metal

		Rockwell Hardness(HRc)		
		1 Layer	2 Layers	4 Layers
On Mild Steel	1.6mm	-	-	60-65
	2.8mm	-	-	64-67

### Typical Operating Procedures

Diameter, Polarity Shielding Gas	CTWD mm (in)	Wire Feed Speed m/min (in/min)	Voltage (volts)	Approx. Current (amps)	Deposition Rate kg/hr (lb/hr)
<b>1.6mm (1/16 in) DC+</b>					
Open Arc	25 (1)	5.0 (196)	28	250	3.5 (7.7)
		7.5 (295)	29	300	6.0 (13.2)
		11.5 (452)	32	350	7.8 (17.2)
<b>2.8mm (7/64in), DC+</b>					
Open Arc	25 (1)	2.9 (117)	28	330	5.2 (11.4)
		3.7 (146)	29	380	6.4 (14.1)
		4.4 (174)	30	430	7.3 (16.0)

# Supershield CrCMo

Cr-Carbide Type

## Conformances

## Applications

- Cement roll mill, bucket teeth and lips, crusher and coke hammers, wear plate

## Features

- Open arc type hardfacing wire
- Cr-Carbide + Mo-Carbide type

## Welding Position



1G  
(PA)

## Current

DC +

## Welding Process

Open Arc

## Diameter / Packaging

Diameter mm (in)	Coil	Pac	
	25kg (55lbs)	150kg (330lbs)	250kg (551lbs)
2.4 (3/32)	✓	✓	✓
2.8 (7/64)	✓	✓	✓

## Typical Chemical Composition of All-Weld Metal (%)

	C	Si	Mn	P	S	Cr	Mo
As welded with 2.4/2.8mm wires	5.2	1.7	0.4	0.011	0.003	27.5	1.2

## Typical Mechanical Properties of All-Weld Metal

		Rockwell Hardness(HRc)		
		1 Layer	2 Layers	4 Layers
		On Mild Steel	2.4mm	-
	2.8mm	-	-	63-67

## Typical Operating Procedures

Diameter, Polarity Shielding Gas	CTWD mm (in)	Wire Feed Speed m/min (in/min)	Voltage (volts)	Approx. Current (amps)	Deposition Rate kg/hr (lb/hr)
2.8mm (7/64in), DC+					
Open Arc	25 (1)	2.9 (117)	28	330	5.2 (11.4)
		3.7 (146)	29	380	6.4 (14.1)
		4.4 (174)	30	430	7.3 (16.0)

SMW

SAW

GMW

GTAW

FCW

Non-FERROUS

APPENDIX

# Supershield CrCV1

Cr-Carbide Type

## Conformances

## Applications

- Cement roll mill, bucket teeth and lips, crusher and coke hammers, wear plate

## Features

- Open arc type hardfacing wire
- Cr-Carbide + V-Carbide type

## Welding Position



1G  
(PA)

## Current

DC +

## Welding Process

Open Arc

## Diameter / Packaging

Diameter	Coil		Pac
	25kg (55lbs)	150kg (330lbs)	250kg (551lbs)
3.2 (1/8)	✓	✓	✓

## Typical Chemical Composition of All-Weld Metal (%)

	C	Si	Mn	P	S	Cr	V	Ti
As welded with 3.2mm wires	5.2	1.2	2.2	0.012	0.003	28.5	0.6	0.1

## Typical Mechanical Properties of All-Weld Metal

	Rockwell Hardness(HRc)		
	1 Layer	2 Layers	4 Layers
On Mild Steel (3.2mm)	-	-	63-65

## Typical Operating Procedures

Diameter, Polarity Shielding Gas	CTWD mm (in)	Wire Feed Speed m/min (in/min)	Voltage (volts)	Approx. Current (amps)	Deposition Rate kg/hr (lb/hr)
3.2mm (1/8in), DC+					
Open Arc	25 (1)	1.5 (60)	29	360	5.4 (11.9)
		1.8 (71)	30	400	6.7 (14.7)
		1.9 (75)	32	430	7.6 (16.7)



# Supershield CrCB

Cr-Carbide Type

## Conformances

## Applications

- Cement roll mill, bucket teeth and lips, crusher and coke hammers, wear plate

## Features

- Open arc type hardfacing wire
- Cr-Carbide + B-Carbide type

## Welding Position



1G  
(PA)

## Current

DC +

## Welding Process

Open Arc

## Diameter / Packaging

Diameter mm (in)	Coil		Pac	
	25kg (55lbs)	150kg (330lbs)	250kg (551lbs)	
2.4 (3/32)	✓	✓	✓	
3.2 (1/8)	✓	✓	✓	

## Typical Chemical Composition of All-Weld Metal (%)

	C	Si	Mn	P	S	Cr	Ti	B
As welded with 2.4/3.2mm wires	4.5	0.6	1.4	0.011	0.002	26.0	0.1	0.3

## Typical Mechanical Properties of All-Weld Metal

		Rockwell Hardness(HRc)		
		1 Layer	2 Layers	4 Layers
		On Mild Steel	2.4mm	-
	3.2mm	-	-	64-67

## Typical Operating Procedures

Diameter, Polarity Shielding Gas	CTWD mm (in)	Wire Feed Speed m/min (in/min)	Voltage (volts)	Approx. Current (amps)	Deposition Rate kg/hr (lb/hr)
3.2mm (1/8in), DC+					
Open Arc	25 (1)	1.5 (60)	29	360	5.4 (11.9)
		1.8 (71)	30	400	6.6 (14.5)
		1.9 (75)	32	430	7.5 (16.5)

SMW

SAW

GMW

GTAW

FCW

Non-FERROUS

APPENDIX

# Supershield AP-0

High Mn/Cr Type

## Conformances

## Applications

- Crusher rolls and hammers, cone mills

## Features

- Open arc type hardfacing wire(buffer layer)
- High-Mn/Cr type

## Welding Position



1G  
(PA)

## Current

DC +

## Welding Process

Open Arc

## Diameter / Packaging

Diameter	Spool		Coil	Pac			
	mm (in)	12.5kg (27.6lbs)		15kg (33lbs)	25kg (55lbs)	150kg (330lbs)	250kg (551lbs)
1.2 (0.045)							
1.6 (1/16)			√				
2.4 (3/32)			√	√	√	√	
2.8 (7/64)			√	√	√	√	
3.2 (1/8)							

## Typical Chemical Composition of All-Weld Metal (%)

	C	Si	Mn	Cr
As welded with 1.6/2.4/2.8mm wire	0.4	0.4	16.0	13.0

## Typical Mechanical Properties of All-Weld Metal

	Rockwell Hardness(HRC) ( $\geq 3$ layers)	
	As welded	Work hardened
On Mild Steel (1.6/2.4/2.8mm)	15~20	40~50

## Typical Operating Procedures

Diameter, Polarity Shielding Gas	CTWD mm (in)	Wire Feed Speed m/min (in/min)	Voltage (volts)	Approx. Current (amps)	Deposition Rate kg/hr (lb/hr)
<b>1.6mm (1/16 in) DC+</b>					
Open Arc	25 (1)	4.9 (192)	26	240	3.4 (7.5)
		7.3 (287)	29	280	4.5 (9.9)
		11.2 (440)	30	330	5.4 (11.9)
<b>2.8mm (7/64in), DC+</b>					
Open Arc	25 (1)	2.9 (114)	27	330	5.0 (11.0)
		3.3 (130)	29	360	5.7 (12.5)
		3.8 (149)	30	400	6.5 (14.3)

# Supershield 16Mn-0

High Mn Type

## Conformances

## Applications

- Crusher rolls and hammers, cone mills

## Features

- Open arc type hardfacing wire(buffer layer)
- High-Mn type

## Welding Position



1G  
(PA)

## Current

DC +

## Welding Process

Open Arc

## Diameter / Packaging

Diameter mm (in)	Spool		Coil	Pac		
	12.5kg (27.6lbs)	15kg (33lbs)	25kg (55lbs)	150kg (330lbs)	250kg (551lbs)	350kg (771lbs)
1.2 (0.045)						
1.6 (1/16)						
2.4 (3/32)			✓	✓	✓	
2.8 (7/64)			✓	✓	✓	
3.2 (1/8)						

### Typical Chemical Composition of All-Weld Metal (%)

	C	Si	Mn	Cr
As welded with 1.6/2.4/2.8mm wire	0.5	0.5	17.0	3.5

### Typical Mechanical Properties of All-Weld Metal

	Rockwell Hardness(HRC) (≥3layers)	
	As welded	Work hardened
On Mild Steel (1.6/2.4/2.8mm)	15~20	40~50

### Typical Operating Procedures

Diameter, Polarity Shielding Gas	CTWD mm (in)	Wire Feed Speed m/min (in/min)	Voltage (volts)	Approx. Current (amps)	Deposition Rate kg/hr (lb/hr)
<b>2.4mm (3/32 in) DC+</b>					
Open Arc	25 (1)	3.6 (144)	26	310	4.3 (9.4)
		4.7 (185)	28	360	6.1 (13.4)
		6.1 (242)	30	410	8.4 (18.5)
<b>2.8mm (7/64in), DC+</b>					
Open Arc	25 (1)	2.9 (114)	27	330	5.2 (11.4)
		3.3 (130)	29	360	5.8 (12.7)
		3.8 (149)	30	400	6.8 (14.9)

# Supershield 309L-0

## Conformances

## Applications

- Crusher rolls and hammers, cone mills

## Features

- Open arc type hardfacing wire(buffer layer)
- High-Cr/Ni stainless steel type

## Welding Position



1G  
(PA)

## Current

DC +

## Welding Process

Open Arc

## Diameter / Packaging

Diameter mm (in)	Coil		Pac	
	25kg (55lbs)	150kg (330lbs)	250kg (551lbs)	
2.8 (7/64)	✓	✓	✓	

## Typical Chemical Composition of All-Weld Metal (%)

	C	Si	Mn	Cr	Ni	Mo
As welded with 2.8mm wire	0.02	0.35	1.4	22.5	12.5	0.05

## Typical Mechanical Properties of All-Weld Metal

	Rockwell Hardness (HRC)	TS MPa(lbs/in <sup>2</sup> )	EL (%)
All-Weld Metal	-	630 (91,400)	38

## Typical Operating Procedures

Diameter, Polarity Shielding Gas	CTWD mm (in)	Wire Feed Speed m/min (in/min)	Voltage (volts)	Approx. Current (amps)	Deposition Rate kg/hr (lb/hr)
<b>2.8mm (7/64in), DC+</b>					
Open Arc	25 (1)	2.9 (114)	27	330	5.1 (11.2)
		3.3 (130)	29	360	5.8 (12.7)
		3.8 (149)	30	400	6.7 (14.7)

# SC-BU Cored

Low Alloy Type

## Conformances

## Applications

- Crain wheels, pulleys

## Features

- Open arc type hardfacing wire(build-up)
- Low alloy type

## Welding Position



1G  
(PA)

## Current

DC +

## Welding Process

Open Arc

## Diameter / Packaging

Diameter	Spool		Coil	Pac		
	12.5kg (27.6lbs)	15kg (33lbs)	25kg (55lbs)	150kg (330lbs)	250kg (551lbs)	350kg (771lbs)
1.2 (0.045)						
1.6 (1/16)						
2.4 (3/32)			✓	✓	✓	
2.8 (7/64)			✓	✓	✓	
3.2 (1/8)						

SMW

SAW

GMW

GTAW

FCW

Non-FERROUS

APPENDIX

**Typical Chemical Composition of All-Weld Metal (%)**

	C	Si	Mn	Cr
As welded with 2.4/2.8mm wire	0.12	0.8	2.7	1.0

**Typical Mechanical Properties of All-Weld Metal**

	Rockwell Hardness(HRC) (≥3layers)
On Mild Steel (2.4/2.8mm)	25-35

**Typical Operating Procedures**

Diameter, Polarity Shielding Gas	CTWD mm (in)	Wire Feed Speed m/min (in/min)	Voltage (volts)	Approx. Current (amps)	Deposition Rate kg/hr (lb/hr)
<b>2.4mm (3/32 in) DC+</b>					
Open Arc	25 (1)	3.2 (127)	26	310	3.9 (8.6)
		4.0 (158)	28	360	4.6 (10.1)
		4.6 (181)	30	410	5.1 (11.2)
<b>2.8mm (7/64in), DC+</b>					
Open Arc	25 (1)	2.9 (114)	27	330	4.9 (10.8)
		3.3 (130)	29	360	5.5 (12.1)
		3.8 (149)	30	400	6.3 (13.8)



# Supershield 430-0

Ferritic STS Type

## Conformances

## Applications

- Continuous casting rolls, steel mill rolls

## Features

- Open arc type hardfacing wire(build-up)
- Ferritic stainless steel type

## Welding Position



1G  
(PA)

## Current

DC +

## Welding Process

Open Arc

## Diameter / Packaging

Diameter mm (in)	Coil	Pac	
	25kg (55lbs)	150kg (330lbs)	250kg (551lbs)
2.4 (3/32)	✓	✓	✓
2.8 (7/64)	✓	✓	✓

## Typical Chemical Composition of All-Weld Metal (%)

	C	Si	Mn	Cr
As welded with 2.4/2.8mm wire	0.05	0.7	0.9	17.0

## Typical Mechanical Properties of All-Weld Metal

	Rockwell Hardness(HRc) (≥3layers)
On Mild Steel (2.4/2.8mm)	5-10

## Typical Operating Procedures

Diameter, Polarity Shielding Gas	CTWD mm (in)	Wire Feed Speed m/min (in/min)	Voltage (volts)	Approx. Current (amps)	Deposition Rate kg/hr (lb/hr)
<b>2.8mm (7/64in), DC+</b>					
Open Arc	25 (1)	2.9 (114)	27	330	4.9 (10.8)
		3.3 (130)	29	360	5.6 (12.3)
		3.8 (149)	30	400	6.5 (14.2)

SMW

SAW

GMAW

GTAW

FCAW

Non-FERROUS

APPENDIX

# Supershield 410NiMo-0

Martentic STS Type

## Conformances

## Applications

- Continuous casting rolls, steel mill rolls

## Features

- Open arc type hardfacing wire
- Martensitic stainless steel type

## Welding Position



1G  
(PA)

## Current

DC +

## Welding Process

Open Arc

## Diameter / Packaging

Diameter mm (in)	Coil		Pac
	25kg (55lbs)	150kg (330lbs)	250kg (551lbs)
2.4 (3/32)	✓	✓	✓
2.8 (7/64)	✓	✓	✓

## Typical Chemical Composition of All-Weld Metal (%)

	C	Si	Mn	Cr	Ni	Mo	Nb
As welded with 2.4/2.8mm wire	0.05	0.7	0.9	13.0	4.0	0.5	0.2

## Typical Mechanical Properties of All-Weld Metal

	Rockwell Hardness(HRC) (≥3layers)
On Mild Steel (2.4/2.8mm)	36-40

## Typical Operating Procedures

Diameter, Polarity Shielding Gas	CTWD mm (in)	Wire Feed Speed m/min (in/min)	Voltage (volts)	Approx. Current (amps)	Deposition Rate kg/hr (lb/hr)
<b>2.8mm (7/64in), DC+</b>					
Open Arc	25 (1)	2.9 (114)	27	330	4.9 (10.8)
		3.3 (130)	29	360	5.5 (12.1)
		3.8 (149)	30	400	6.6 (14.5)

# SC-410NiMoS

Martentic STS Type

## Conformances

## Applications

- Continuous casting rolls, steel mill rolls

## Features

- Submerged arc type hardfacing wire
- Martensitic stainless steel type

## Welding Position



1G  
(PA)

## Current

DC +

## Welding Process

SAW(with S-717/S-400HF flux)

## Diameter / Packaging

Diameter	Coil			Pac	
	25kg (55lbs)	150kg (330lbs)	250kg (551lbs)		
3.2(1/8)	✓	✓	✓		

## Typical Chemical Composition of All-Weld Metal (%)

	C	Si	Mn	Cr	Ni	Mo
As welded with 3.2mm wire	0.05	0.7	1.7	13.0	4.5	0.5

## Typical Mechanical Properties of All-Weld Metal

	Rockwell Hardness(HRc) (≥3layers)
On Mild Steel (2.4/2.8mm)	36-40

## Typical Operating Procedures

Diameter, Polarity Shielding Gas	CTWD mm (in)	Wire Feed Speed m/min (in/min)	Voltage (volts)	Approx. Current (amps)	Deposition Rate kg/hr (lb/hr)
3.2mm (1/8in), DC+					
Submerged Arc	25 (1)	1.4 (55)	28	350	3.7 (8.2)
		1.7 (66)	30	390	4.5 (9.9)
		1.8 (72)	31	430	5.3 (11.6)

SM/AW

SAW

GM/AW

GT/AW

FC/AW

Non-FERROUS

APPENDIX

# SC-414S

Martentic STS Type

## Conformances

## Applications

- Continuous casting rolls, steel mill rolls

## Features

- Submerged arc type hardfacing wire
- Martensitic stainless steel type

## Welding Position



1G  
(PA)

## Current

DC +

## Welding Process

SAW(with S-717/S-400HF flux)

## Diameter / Packaging

Diameter mm (in)	Coil		Pac	
	25kg (55lbs)	150kg (330lbs)	250kg (551lbs)	
2.4 (3/32)	✓	✓	✓	
3.2 (1/8)	✓	✓	✓	

## Typical Chemical Composition of All-Weld Metal (%)

	C	Si	Mn	Cr	Ni	Mo	Nb	V
As welded with 2.4/3.2mm wire	0.11	0.6	1.5	13.8	2.8	1.1	0.2	0.3

## Typical Mechanical Properties of All-Weld Metal

	Rockwell Hardness(HRC) (≥3layers)
On Mild Steel (2.4/3.2mm)	42~46

## Typical Operating Procedures

Diameter, Polarity Shielding Gas	CTWD mm (in)	Wire Feed Speed m/min (in/min)	Voltage (volts)	Approx. Current (amps)	Deposition Rate kg/hr (lb/hr)
3.2mm (1/8in), DC+					
Submerged Arc	25 (1)	1.4 (55)	28	350	3.8 (8.4)
		1.7 (66)	30	390	4.6 (10.1)
		1.8 (72)	31	430	5.2 (11.4)

# SC-420S

Martentic STS Type

## Conformances

## Applications

- Continuous casting rolls, steel mill rolls

## Features

- Submerged arc type hardfacing wire
- Martensitic stainless steel type

## Welding Position



1G  
(PA)

## Current

DC +

## Welding Process

SAW(with S-717/S-400HF flux)

## Diameter / Packaging

Diameter mm (in)	Coil	Pac	
	25kg (55lbs)	150kg (330lbs)	250kg (551lbs)
2.8 (7/64)	✓	✓	✓
3.2 (1/8)	✓	✓	✓

## Typical Chemical Composition of All-Weld Metal (%)

	C	Si	Mn	Cr	Ni	Mo	Nb	V	W
As welded with 2.8/3.2mm wire	0.3	0.6	1.8	12.5	0.5	1.6	0.15	0.3	1.3

## Typical Mechanical Properties of All-Weld Metal

	Rockwell Hardness(HRC) (≥3layers)
On Mild Steel (2.8/3.2mm)	48-55

## Typical Operating Procedures

Diameter, Polarity Shielding Gas	CTWD mm (in)	Wire Feed Speed m/min (in/min)	Voltage (volts)	Approx. Current (amps)	Deposition Rate kg/hr (lb/hr)
3.2mm (1/8in), DC+					
Submerged Arc	25 (1)	1.4 (55)	28	350	3.9 (8.6)
		1.7 (66)	30	390	4.6 (10.1)
		1.8 (72)	31	430	5.3 (11.6)

# SC-420SG

Martentic STS Type

## Conformances

## Applications

- Continuous casting rolls, steel mill rolls

## Features

- Submerged arc type hardfacing wire
- Martensitic stainless steel type

## Welding Position



1G  
(PA)

## Current

DC +

## Welding Process

SAW(with S-717/S-400HF flux)

## Diameter / Packaging

Diameter mm (in)	Coil		
	25kg (55lbs)	150kg (330lbs)	250kg (551lbs)
1.6 (1/16)	√	√	√
2.4 (3/32)	√		
3.2 (1/8)	√	√	√

## Typical Chemical Composition of All-Weld Metal (%)

	C	Si	Mn	Cr	Ni	Nb
As welded with 1.6/2.4/3.2mm wire	0.2	0.6	1.5	13.0	0.2	0.15

## Typical Mechanical Properties of All-Weld Metal

	Rockwell Hardness(HRC) (≥3layers)
On Mild Steel (1.6/2.4/3.2mm)	48-55

## Typical Operating Procedures

Diameter, Polarity Shielding Gas	CTWD mm (in)	Wire Feed Speed m/min (in/min)	Voltage (volts)	Approx. Current (amps)	Deposition Rate kg/hr (lb/hr)
<b>1.6mm (1/16 in) DC+</b>					
Submerged Arc	25 (1)	4.9 (192)	26	240	2.4 (5.3)
		7.3 (287)	29	280	3.5 (7.7)
		11.2 (440)	30	330	4.4 (9.7)
<b>3.2mm (1/8in), DC+</b>					
Submerged Arc	25 (1)	1.4 (55)	28	350	3.8 (8.4)
		1.7 (66)	30	390	4.5 (9.9)
		1.8 (72)	31	430	5.2 (11.4)

# SC-423S

Ferritic STS Type

## Conformances

## Applications

- Continuous casting rolls, steel mill rolls

## Features

- Submerged arc type hardfacing wire(build-up)
- Ferritic stainless steel type

## Welding Position



1G  
(PA)

## Current

DC +

## Welding Process

SAW(with S-717/S-400HF flux)

## Diameter / Packaging

Diameter	Coil		
	25kg (55lbs)	150kg (330lbs)	250kg (551lbs)
3.2(1/8)	✓	✓	✓

## Typical Chemical Composition of All-Weld Metal (%)

	C	Si	Mn	Cr	Ni	Mo	Nb	V
As welded with 3.2mm wire	0.06	0.4	1.4	17.0	2.4	1.1	0.2	0.3

## Typical Mechanical Properties of All-Weld Metal

	Rockwell Hardness(HRc) (≥3layers)
On Mild Steel (3.2mm)	5-10

## Typical Operating Procedures

Diameter, Polarity Shielding Gas	CTWD mm (in)	Wire Feed Speed m/min (in/min)	Voltage (volts)	Approx. Current (amps)	Deposition Rate kg/hr (lb/hr)
3.2mm (1/8in), DC+					
Submerged Arc	25 (1)	1.4 (55)	28	350	3.7 (8.1)
		1.7 (66)	30	390	4.4 (9.7)
		1.8 (72)	31	430	5.2 (11.4)

SMW

SAW

GMW

GTAW

FCW

Non-FERROUS

APPENDIX

# SC-430S

Ferritic STS Type

## Conformances

## Applications

- Continuous casting rolls, steel mill rolls

## Features

- Submerged arc type hardfacing wire(build-up)
- Ferritic stainless steel type

## Welding Position



1G  
(PA)

## Current

DC +

## Welding Process

SAW(with S-717/S-400HF flux)

## Diameter / Packaging

Diameter mm (in)	Coil		Pac	
	25kg (55lbs)	150kg (330lbs)	250kg (551lbs)	
3.2 (1/8)	✓	✓	✓	

## Typical Chemical Composition of All-Weld Metal (%)

	C	Si	Mn	Cr
As welded with 2.4/3.2mm wire	0.05	0.7	1.3	17.0

## Typical Mechanical Properties of All-Weld Metal

	Rockwell Hardness(HRC) (≥3layers)
On Mild Steel (2.4/3.2mm)	5-10

## Typical Operating Procedures

Diameter, Polarity Shielding Gas	CTWD mm (in)	Wire Feed Speed m/min (in/min)	Voltage (volts)	Approx. Current (amps)	Deposition Rate kg/hr (lb/hr)
<b>3.2mm (1/8in), DC+</b>					
Submerged Arc	25 (1)	1.4 (55)	28	350	3.8 (8.4)
		1.7 (66)	30	390	4.5 (9.9)
		1.8 (72)	31	430	5.3 (11.6)



# SC-30S

Low / Middle Alloy Type

## Conformances

## Applications

- Crane wheels, rod wheels, tractor roller

## Features

- Submerged arc type hardfacing wire
- Low/Middle alloy type

## Welding Position



1G  
(PA)

## Current

DC +

## Welding Process

SAW(with S-717/S-400HF flux)

## Diameter / Packaging

Diameter	Coil			Pac	
	25kg (55lbs)	150kg (330lbs)	250kg (551lbs)		
3.2(1/8)	✓	✓	✓		

## Typical Chemical Composition of All-Weld Metal (%)

	C	Si	Mn	Cr	Mo
As welded with 3.2mm wire	0.15	0.2	1.5	1.6	0.3

## Typical Mechanical Properties of All-Weld Metal

	Rockwell Hardness(HRc) (≥3layers)
On Mild Steel (3.2mm)	30-33

## Typical Operating Procedures

Diameter, Polarity Shielding Gas	CTWD mm (in)	Wire Feed Speed m/min (in/min)	Voltage (volts)	Approx. Current (amps)	Deposition Rate kg/hr (lb/hr)
3.2mm (1/8in), DC+					
Submerged Arc	25 (1)	1.4 (58)	28	350	4.2 (9.2)
		1.7 (70)	30	390	5.1 (11.2)
		1.9 (76)	31	430	5.8 (12.7)

SMW

SAW

GMW

GTAW

FCW

Non-FERROUS

APPENDIX

# SC-45S

Low / Middle Alloy Type

## Conformances

## Applications

- Crane wheels, rod wheels, tractor roller

## Features

- Submerged arc type hardfacing wire
- Low/Middle alloy type

## Welding Position



1G  
(PA)

## Current

DC +

## Welding Process

SAW(with S-717/S-400HF flux)

## Diameter / Packaging

Diameter	Coil		Pac
	25kg (55lbs)	150kg (330lbs)	250kg (551lbs)
3.2 (1/8)	✓	✓	✓

## Typical Chemical Composition of All-Weld Metal (%)

	C	Si	Mn	Cr	Mo
As welded with 3.2mm wire	0.2	0.4	1.8	3.0	0.5

## Typical Mechanical Properties of All-Weld Metal

	Rockwell Hardness(HRC) (≥3layers)
On Mild Steel (3.2mm)	43~48

## Typical Operating Procedures

Diameter, Polarity Shielding Gas	CTWD mm (in)	Wire Feed Speed m/min (in/min)	Voltage (volts)	Approx. Current (amps)	Deposition Rate kg/hr (lb/hr)
<b>3.2mm (1/8in), DC+</b>					
Submerged Arc	25 (1)	1.4 (58)	28	350	4.3 (9.4)
		1.7 (70)	30	390	5.2 (11.4)
		1.9 (76)	31	430	5.9 (12.9)

# SC-55S

Middle Alloy Type

## Conformances

## Applications

- Crane wheels, rod wheels, tractor roller

## Features

- Submerged arc type hardfacing wire
- Low/Middle alloy type

## Welding Position



1G  
(PA)

## Current

DC +

## Welding Process

SAW(with S-717/S-400HF flux)

## Diameter / Packaging

Diameter	Pack		
	Coil	150kg	250kg
mm (in)	25kg (55lbs)	(330lbs)	(551lbs)
3.2(1/8)	✓	✓	✓

## Typical Chemical Composition of All-Weld Metal (%)

	C	Si	Mn	Cr	Mo	W
As welded with 3.2mm wire	0.3	0.5	1.5	6.0	1.5	1.5

## Typical Mechanical Properties of All-Weld Metal

	Rockwell Hardness(HRC) (≥3layers)
On Mild Steel (3.2mm)	50-55

## Typical Operating Procedures

Diameter, Polarity Shielding Gas	CTWD mm (in)	Wire Feed Speed m/min (in/min)	Voltage (volts)	Approx. Current (amps)	Deposition Rate kg/hr (lb/hr)
3.2mm (1/8in), DC+					
Submerged Arc	25 (1)	1.4 (58)	28	350	4.5 (9.9)
		1.7 (70)	30	390	5.3 (11.6)
		1.9 (76)	31	430	6.0 (13.1)

SMW

SAW

GMW

GTAW

FCW

Non-FERROUS

APPENDIX

# SC-A4S

Low Alloy Type

## Conformances

AWS A5.23/ ASME SFA5.23 F8P2 ECA4-A4

## Applications

- High strength steel, creep resisting steel

## Features

- Submerged arc type hardfacing wire
- Low alloy type

## Welding Position



1G  
(PA)

## Current

DC +

## Welding Process

SAW(with S-717/S-400HF flux)

## Diameter / Packaging

Diameter mm (in)	Coil		Pac
	25kg (55lbs)	150kg (330lbs)	250kg (551lbs)
2.4 (3/32)	√	√	√

## Typical Chemical Composition of All-Weld Metal (%)

	C	Si	Mn	Mo
As welded with 2.4mm wire	0.10	0.5	1.4	0.5

	TS MPa(lbs/in <sup>2</sup> )	EL (%)	Temp °C(°F)	CVN-Impact Value J (ft.-lbs)	Heat Treatment
As welded with 2.4mm wire	676 (97,000)	24.4	-29 (-20)	70 (52)	600°C (1,112°F) X 1hr FC

## Typical Operating Procedures

Diameter, Polarity Shielding Gas	CTWD mm (in)	Wire Feed Speed m/min (in/min)	Voltage (volts)	Approx. Current (amps)	Deposition Rate kg/hr (lb/hr)
<b>2.4mm (3/32in), DC+</b>					
Submerged Arc	25 (1)	3.2 (127)	26	310	3.9 (8.6)
		4.0 (158)	28	360	4.6 (10.1)
		4.6 (181)	30	410	5.1 (11.2)

# SC-42H

For Hard-facing

## Conformances

## Applications

- Crain wheels, gear, shaft etc.

## Features

- Flat and horizontal fillet position welding
- Suitable for metal to metal wear and abrasion parts

## Welding Position



1G 2F  
(PA) (PB)

## Current

DC +

## Shielding Gas

100% CO<sub>2</sub> / FCAW process

## Diameter / Packaging

Diameter	Spool
mm (in)	15kg (33lbs)
1.6 (1/16)	✓

## Typical Chemical Composition of All-Weld Metal (%)

C	Si	Mn	Cr	Mo	V	Nb	Co
0.1	0.5	1.5	4.9	2.5	0.35	0.35	1.0

## Typical Mechanical Properties of All-Weld Metal

	Rockwell Hardness(HRc) (≥3layers)
On Mild Steel (1.6mm)	41~44

## Typical Operating Procedures

Diameter, Polarity Shielding Gas	CTWD mm (in)	Wire Feed Speed m/min (in/min)	Voltage (volts)	Approx. Current (amps)	Deposition Rate kg/hr (lb/hr)
1.6mm (1/16in), DC+					
100% CO <sub>2</sub>	20(4/5)	5.8 (228)	27~29	260	4.9 (10.8)
		7.9 (311)	28~30	300	5.6 (12.3)
		9.7 (381)	29~31	330	7.4 (16.3)

SMW

SAW

GMAW

GTAW

FCAW

Non-FERROUS

APPENDIX

# SC-250H

For Hard-facing

## Conformances

JIS Z3326 YF2A-C-250

## Applications

- Spindle, gear, shaft etc.

## Features

- Flat and horizontal fillet position welding
- Suitable for metal to metal wear parts

## Welding Position



1G 2F  
(PA) (PB)

## Current

DC +

## Shielding Gas

100% CO<sub>2</sub> / FCAW process

## Diameter / Packaging

Diameter	Spool
mm (in)	15kg (33lbs)
1.2 (0.045)	✓
1.6 (1/16)	✓

## Typical Chemical Composition of All-Weld Metal (%)

C	Si	Mn	P	S	Cr	Mo	Others
0.06	0.57	1.30	0.011	0.005	1.20	-	-

## Typical Mechanical Properties of All-Weld Metal

Hardness (Hv)

260-300

## Typical Operating Procedures

Diameter, Polarity Shielding Gas	CTWD mm (in)	Wire Feed Speed m/min (in/min)	Voltage (volts)	Approx. Current (amps)	Deposition Rate kg/hr (lb/hr)
1.2mm (0.045 in) DC+					
100% CO <sub>2</sub>	20 (4/5)	9.8 (385)	25-27	230	4.0 (8.8)
		12.5 (492)	27-29	260	5.1 (11.2)
		14.2 (559)	29-31	300	6.0 (13.2)
1.6mm (1/16 in) DC+					
100% CO <sub>2</sub>	20 (4/5)	5.8 (228)	27-29	260	4.6 (10.1)
		7.9 (311)	28-30	300	5.4 (11.9)
		9.7 (381)	29-31	330	6.9 (15.2)

# SC-350H

For Hard-facing

## Conformances

JIS Z3326 YF2A-C-350

## Applications

- Spindle, gear, shaft etc.

## Features

- Flat and horizontal fillet position welding
- Suitable for metal to metal wear parts

## Welding Position



1G 2F  
(PA) (PB)

## Current

DC +

## Shielding Gas

100% CO<sub>2</sub> / FCAW process

## Diameter / Packaging

Diameter	Spool
mm (in)	15kg (33lbs)
1.2 (0.045)	√
1.6 (1/16)	√

## Typical Chemical Composition of All-Weld Metal (%)

C	Si	Mn	P	S	Cr	Mo	Others
0.10	0.6	1.6	0.015	0.006	1.2	0.3	-

## Typical Mechanical Properties of All-Weld Metal

Hardness (Hv)

350-400

## Typical Operating Procedures

Diameter, Polarity Shielding Gas	CTWD mm (in)	Wire Feed Speed m/min (in/min)	Voltage (volts)	Approx. Current (amps)	Deposition Rate kg/hr (lb/hr)
<b>1.2mm (0.045 in) DC+</b>					
100% CO <sub>2</sub>	20 (4/5)	9.8 (385)	25-27	230	4.1 (9.0)
		12.5 (492)	27-29	260	5.2 (11.4)
		14.2 (559)	29-31	300	6.0 (13.2)
<b>1.6mm (1/16 in) DC+</b>					
100% CO <sub>2</sub>	20 (4/5)	5.8 (228)	27-29	260	4.7 (10.3)
		7.9 (311)	28-30	300	5.4 (11.9)
		9.7 (381)	29-31	330	7.0 (15.4)

SMW

SAW

GMW

GTAW

FCAW

Non-FERROUS

APPENDIX

# SC-450H

For Hard-facing

## Conformances

JIS Z3326 YF2A-C-450

## Applications

- Crain wheels, gear, shaft etc.

## Features

- Flat and horizontal fillet position welding
- Suitable for metal to metal wear and abrasion parts

## Welding Position



1G 2F  
(PA) (PB)

## Current

DC +

## Shielding Gas

100% CO<sub>2</sub> / FCAW process

## Diameter / Packaging

Diameter	Spool
mm (in)	15kg (33lbs)
1.2 (0.045)	✓
1.4 (0.052)	✓
1.6 (1/16)	✓

## Typical Chemical Composition of All-Weld Metal (%)

C	Si	Mn	P	S	Cr	Mo	Others
0.2	0.7	1.5	0.018	0.007	1.8	0.6	-

## Typical Mechanical Properties of All-Weld Metal

Hardness (Hv)

450-500

## Typical Operating Procedures

Diameter, Polarity Shielding Gas	CTWD mm (in)	Wire Feed Speed m/min (in/min)	Voltage (volts)	Approx. Current (amps)	Deposition Rate kg/hr (lb/hr)
1.2mm (0.045 in) DC+					
100% CO <sub>2</sub>	20 (4/5)	9.8 (385)	25-27	230	4.3 (9.4)
		12.5 (492)	27-29	260	5.2 (11.3)
		14.2 (559)	29-31	300	6.0 (13.2)
1.6mm (1/16 in) DC+					
100% CO <sub>2</sub>	20 (4/5)	5.8 (228)	27-29	260	4.8 (10.5)
		7.9 (311)	28-30	300	5.5 (12.1)
		9.7 (381)	29-31	330	7.2 (15.8)



# SC-600H

For Hard-facing

## Conformances

JIS Z3326 YF3B-C-600

## Applications

- Rollers, shear blades, screw conveyer etc.

## Features

- Flat and horizontal fillet position welding
- Suitable for abrasion parts

## Welding Position



1G 2F  
(PA) (PB)

## Current

DC +

## Shielding Gas

100% CO<sub>2</sub> / FCAW process

## Diameter / Packaging

Diameter mm (in)	Spool 15kg (33lbs)
1.2 (0.045)	√
1.4 (0.052)	√
1.6 (1/16)	√

## Typical Chemical Composition of All-Weld Metal (%)

C	Si	Mn	Cr	Mo	V	W	Others
0.35	0.5	0.7	4.2	0.6	-	-	-

## Typical Mechanical Properties of All-Weld Metal

Hardness (Hv)

620-680

## Typical Operating Procedures

Diameter, Polarity Shielding Gas	CTWD mm (in)	Wire Feed Speed m/min (in/min)	Voltage (volts)	Approx. Current (amps)	Deposition Rate kg/hr (lb/hr)
<b>1.2mm (0.045 in) DC+</b>					
100% CO <sub>2</sub>	20 (4/5)	9.8 (385)	25-27	230	4.4 (9.7)
		12.5 (492)	27-29	260	5.3 (11.6)
		14.2 (559)	29-31	300	6.1 (13.4)
<b>1.6mm (1/16 in) DC+</b>					
100% CO <sub>2</sub>	20 (4/5)	5.8 (228)	27-29	260	4.9 (10.8)
		7.9 (311)	28-30	300	5.7 (12.5)
		9.7 (381)	29-31	330	7.3 (16.0)

SMW

SAW

GMW

GTAW

FCAW

Non-FERROUS

APPENDIX

# SC-600HM

For Hard-facing

## Conformances

DIN 8555 MSG 6-GF-60-P

## Applications

- Rollers, shear blades, screw conveyer etc.

## Features

- Flat and horizontal fillet position welding
- Suitable for abrasion parts

## Welding Position



1G 2F  
(PA) (PB)

## Current

DC +

## Shielding Gas

Ar + 20~25% CO<sub>2</sub>

FCAW process

## Diameter / Packaging

Diameter mm (in)	Spool 15kg (33lbs)
1.2 (0.045)	✓
1.6 (1/16)	✓

## Typical Chemical Composition of All-Weld Metal (%)

C	Si	Mn	P	S	Cr	Mo
0.5	0.3	1.5	0.012	0.009	6.2	0.35

## Typical Mechanical Properties of All-Weld Metal

Hardness (HRC)

58-62

## Typical Operating Procedures

Diameter, Polarity Shielding Gas	CTWD mm (in)	Wire Feed Speed m/min (in/min)	Voltage (volts)	Approx. Current (amps)	Deposition Rate kg/hr (lb/hr)
1.2mm (0.045 in) DC+					
80% Ar + 20% CO <sub>2</sub>	20 (4/5)	9.8 (385)	25-27	230	4.5 (9.9)
		12.5 (492)	27-29	260	5.5 (12.1)
		14.2 (559)	29-31	300	6.4 (14.1)
1.6mm (1/16 in) DC+					
80% Ar + 20% CO <sub>2</sub>	20 (4/5)	5.8 (228)	27-29	260	5.3 (11.6)
		7.9 (311)	28-30	300	6.2 (13.6)
		9.7 (381)	29-31	330	7.6 (16.7)

# SC-700H

For Hard-facing

## Conformances

JIS Z3326 YF3B-C-700

## Applications

- Rollers, shear blades, screw conveyer etc.

## Features

- Flat and horizontal fillet position welding
- Suitable for abrasion parts

## Welding Position



1G 2F  
(PA) (PB)

## Current

DC +

## Shielding Gas

100% CO<sub>2</sub> / FCAW process

## Diameter / Packaging

Diameter	Spool
mm (in)	15kg (33lbs)
1.2 (0.045)	✓
1.4 (0.052)	✓
1.6 (1/16)	✓

## Typical Chemical Composition of All-Weld Metal (%)

C	Si	Mn	Cr	Mo	V	W	Others
0.7	0.6	1.3	5.2	-	-	0.4	-

## Typical Mechanical Properties of All-Weld Metal

Hardness (Hv)

700-720

## Typical Operating Procedures

Diameter, Polarity Shielding Gas	CTWD mm (in)	Wire Feed Speed m/min (in/min)	Voltage (volts)	Approx. Current (amps)	Deposition Rate kg/hr (lb/hr)
<b>1.2mm (0.045 in) DC+</b>					
100% CO <sub>2</sub>	20 (4/5)	9.8 (385)	25-27	230	4.4 (9.7)
		12.5 (492)	27-29	260	5.4 (11.9)
		14.2 (559)	29-31	300	6.3 (13.8)
<b>1.6mm (1/16 in) DC+</b>					
100% CO <sub>2</sub>	20 (4/5)	5.8 (228)	27-29	260	5.1 (11.2)
		7.9 (311)	28-30	300	5.9 (13.0)
		9.7 (381)	29-31	330	7.4 (16.3)

SMW

SAW

GMW

GTAW

FCAW

Non-FERROUS

APPENDIX

# Note

---

# Non-FERROUS

## Non-Ferrous Metal Welding Consumables



# SR-133

## Conformances

AWS A5.11/ ASME SFA5.11 ENiCrFe-2  
 JIS Z3224 DNiCrFe-2  
 EN ISO 14172 Ni 6092

## Applications

- Inconel 600, 601, Incoloy 800 and 800HT
- Dissimilar welding of stainless steels and low-alloy steels & Nickel-alloy steel(Inconel, Incoloy, Monel alloys)
- Overlay cladding on similar chemical composition steels

## Features

- High impact toughness at low temperature
- Good Arc & slag stability and hot cracking resistance
- Good productivity

## Welding Position

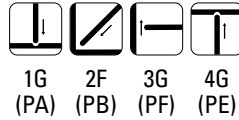

## Current

DC +

## Diameter / Packaging

Diameter mm (in)	Length mm(in)
2.6 (3/32)	350 (14)
3.2 (1/8)	✓
4.0 (5/32)	✓
5.0 (3/16)	✓

## Typical Chemical Composition of All-Weld Metal (%)

C	Si	Mn	P	S	Cr	Ni	Mo	Cu	Nb+Ta	Fe
0.05	0.15	3.1	0.005	0.003	15.0	71.5	1.0	0.01	1.25	7.5

## Typical Mechanical Properties of All-Weld Metal

YS MPa(lbs/in <sup>2</sup> )	TS MPa(lbs/in <sup>2</sup> )	EL (%)	Temp °C(°F)	CVN-Impact Value J (ft.lbs)
395 (57,000)	610 (88,000)	37.0	-196 (-321)	91 (67)

## Typical Operating Procedures

Diameter	Approx. Current (amps)		
	3.2mm (1/8) DC +	4.0mm (5/32) DC +	5.0mm (3/16) DC +
F	70~90	110~140	120~150
V-up	70~90	100~130	110~140

# SR-182

## Conformances

AWS A5.11/ASME SFA5.11 ENiCrFe-3  
 JIS Z3224 DNiCrFe-  
 EN ISO 14172 Ni 6182

## Applications

- Inconel 600, 601 and stainless steels & low-alloy steel & nickel-alloy steel.
- Ni-Cr-Fe alloy clad steels

## Features

- Good crack resistance
- Good arc stability and good slag removal
- Good bead appearance

## Welding Position

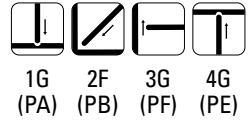

## Current

DC +

## Diameter / Packaging

Diameter mm (in)	Length mm(in)	
	300 (12)	350 (14)
2.6 (3/32)	√	
3.2 (1/8)		√
4.0 (5/32)		√
5.0 (3/16)		√

## Typical Chemical Composition of All-Weld Metal (%)

C	Si	Mn	P	S	Cr	Ti	Nb+Ta	Fe	Ni
0.06	0.46	6.5	0.011	0.010	16.3	0.07	1.8	5.2	72.0

## Typical Mechanical Properties of All-Weld Metal

YS MPa(lbs/in <sup>2</sup> )	TS MPa(lbs/in <sup>2</sup> )	EL (%)	Temp °C(°F)	CVN-Impact Value J (ft.lbs)
-	650 (94,000)	35.0	-196 (-321)	80 (59)

## Typical Operating Procedures

Diameter	Approx. Current (amps)			
	2.6mm (3/32) DC +	3.2mm (1/8) DC +	4.0mm (5/32) DC +	5.0mm (3/16) DC +
F&HF	60~90	70~115	100~140	120~160
V-up	60~90	65~110	100~130	110~140

# SR-134

## Conformances

AWS A5.11/ ASME SFA5.11 ENiCrFe-4  
 JIS Z3225 D9Ni-1  
 KOGAS

## Welding Position

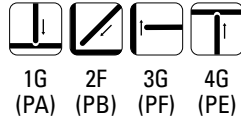

## Applications

- 9%Ni steel for cryogenic storage tanks for LNG
- Liquefied nitrogen tanks

## Features

- Good strength and toughness at cryogenic temperatures
- Meets specifications of API and NV for the welding of 9%Ni steel With AC

## Current

AC

## Diameter / Packaging

Diameter	Length mm(in)
mm (in)	350 (14)
2.6 (3/32)	
3.2 (1/8)	✓
4.0 (5/32)	✓
5.0 (3/16)	✓

## Typical Chemical Composition of All-Weld Metal (%)

C	Si	Mn	P	S	Cr	Ni	Mo	Nb	Fe
0.07	0.4	2.8	0.01	0.02	15.5	70.7	2.2	2.2	5.3

## Typical Mechanical Properties of All-Weld Metal

YS MPa(lbs/in <sup>2</sup> )	TS MPa(lbs/in <sup>2</sup> )	EL (%)	Temp °C(°F)	CVN-Impact Value J (ft.-lbs)
-	705 (102,000)	40.5	-196 (-321)	60 (44)

## Typical Operating Procedures

Diameter	Approx. Current (amps)		
	3.2mm (1/8) AC	4.0mm (5/32) AC	5.0mm (3/16) AC
F	70~90	110~140	120~150
V-up	70~90	100~130	110~140



# SR-08

## Conformances

AWS A5.11/ ASME SFA5.11 ENiMo-8

## Applications

- Repair welding and tack welding of 9%Ni steel
- LNG Storage tanks

## Features

- Good impact toughness at extra low temperature

## Welding Position



1G (PA) 2F (PB) 3G (PF) 4G (PE)

## Current

AC

## Diameter / Packaging

Diameter	Length mm(in)
mm (in)	350 (14)
2.6 (3/32)	
3.2 (1/8)	✓
4.0 (5/32)	✓
5.0 (3/16)	

## Typical Chemical Composition of All-Weld Metal (%)

C	Si	Mn	P	S	Cr	Ni	Mo	W	Fe
0.03	0.25	0.3	0.002	0.001	2.6	67.0	18.5	3.1	6.0

## Typical Mechanical Properties of All-Weld Metal

YS MPa(lbs/in <sup>2</sup> )	TS MPa(lbs/in <sup>2</sup> )	EL (%)	Temp °C(°F)	CVN-Impact Value J (ft.lbs)
-	730 (106,000)	41.0	-196 (-321)	80 (59)

## Typical Operating Procedures

Approx. Current (amps)		
Diameter	3.2mm (1/8) AC	4.0mm (5/32) AC
F	70-90	110-140
V-up	70-90	100-130

# SR-625

## Conformances

AWS A5.11/ASME SFA5.11 ENiCrMo-3  
 JIS Z3224 DNiCrMo-3  
 EN ISO 14172 Ni 6625(NiCr22Mo9Nb)  
 ABS AWS A5.11 ERNiCrMo-3

## Applications

- Inconel 601 + 625, steel and Nickel alloys Hardfacing of steel
- 9% Nickel steel
- LNG storage tank manufactures and desulfurizations
- Heat exchanger Building of chemical carrier

## Features

- Good corrosion resistance to Crevice and Pitting, SCC
- Good Tensile Strength at High Temperature
- Good Impact value at Cryogenic temperature

## Welding Position

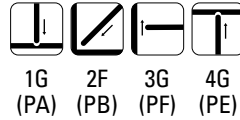

## Current

DC +, AC

## Diameter / Packaging

Diameter mm (in)	Length mm(in)	
	300 (12)	350 (14)
2.6 (3/32)	✓	
3.2 (1/8)		✓
4.0 (5/32)		✓
5.0 (3/16)		✓

## Typical Chemical Composition of All-Weld Metal (%)

C	Si	Mn	P	S	Cr	Ni	Mo	Nb+Ta
0.06	0.4	0.1	0.001	0.004	21.7	63.4	9.3	3.32

## Typical Mechanical Properties of All-Weld Metal

YS MPa(lbs/in <sup>2</sup> )	TS MPa(lbs/in <sup>2</sup> )	EL (%)	Temp °C(°F)	CVN-Impact Value J (ft.-lbs)
-	780 (113,000)	36.0	-196 (-321)	45 (33)

## Typical Operating Procedures

Diameter	Approx. Current (amps)			
	2.6mm (3/32) DC +	3.2mm (1/8) DC +	4.0mm (5/32) DC +	5.0mm (3/16) DC +
F	60~90	70~110	110~140	120~150
V-up/OH	60~90	70~110	100~130	110~140

# Superflux300 X SA-625

## Conformances

## Applications

- Furnace equipments
- Petrochemical plants
- Power generation plants

## Features

- Bonded type flux, High basicity flux
- Good arc stability and slag removal
- Good bead appearance and weldability

## Welding Position

## Current

DC +

## Diameter / Packaging

Diameter	Spool
mm (in)	25kg (55lbs)
2.0 (5/64)	✓
2.4 (3/32)	✓
3.2 (1/8)	✓
4.0 (5/32)	✓

## Typical Chemical Composition of All-Weld Metal (%)

C	Si	Mn	P	S	Cr	Ni	Mo	Nb+Ta
0.02	0.58	0.27	0.011	0.005	20.8	65.5	8.6	3.3

## Typical Mechanical Properties of All-Weld Metal

YS MPa(lbs/in <sup>2</sup> )	TS MPa(lbs/in <sup>2</sup> )	EL (%)	Temp °C(°F)	CVN-Impact Value J (ft.lbs)
-	715 (104,000)	37.7	-196 (-321)	60 (44)

## Typical Operating Procedures

Wire Feed Speed m/min (in/min)	Voltage (volts)	Approx. Current (amps)
2.4mm (3/32 in) DC+		
30-60	28-31	350-400

SMW

SAW

GMAW

GTAW

FCAW

Non-FERROUS

APPENDIX

# SMT-625

## Conformances

AWS A5.14/ ASME SFA5.14 ERNiCrMo-3  
JIS Z3334 SNi6625(NiCr22Mo9Nb)  
EN ISO 18274 Ni 6625 (NiCr22Mo9Nb)  
ABS AWS A5.14 ERNiCrMo-3 (-196°C ≥34 J)  
GL NiCr21Mo9Nb  
LR 9Ni H15

DNV -MS  
NV 1.5Ni, 9Ni  
KR L92S  
NK KSWL92  
BV AWS A5.14 ERNiCrMo-3

## Applications

- LNG Storage Tank, Equipments for gas desulfurization,
- Petrochemical plants
- Heat exchangers
- 9% nickel steel

## Features

- Good impact toughness at extra low temperature
- Dissimilar steels(B24Inconel 601, Incoloy800/800H or combination of these with other alloys)

## Welding Position

### Current

GMAW: DC+(Pulse)  
GTAW: DC-

### Shielding Gas

Ar  
Ar + He

## Diameter / Packaging

Diameter	MIG	TIG
mm (in)	12.5kg (27.6lbs)	5kg (11lbs)
0.9 (0.035)	✓	
1.0 (0.040)	✓	
1.2 (0.045)	✓	
1.4 (0.052)	✓	
1.6 (1/16)	✓	
2.0 (5/64)		✓
2.4 (3/32)		✓
3.2 (1/8)		✓

**Typical Chemical Composition of All-Weld Metal (%)**

C	Si	Mn	P	S	Cr	Ni	Mo	Nb+Ta
0.02	0.05	0.03	0.012	0.001	22.0	64.6	8.7	3.6

**Typical Mechanical Properties of All-Weld Metal**

YS MPa(lbs/in <sup>2</sup> )	TS MPa(lbs/in <sup>2</sup> )	EL (%)	Temp °C(°F)	CVN-Impact Value J (ft.-lbs)
-	770 (117,000)	40.0	-196 (-321)	100 (74)

**Typical Operating Procedures**

Diameter, Polarity Shielding Gas	Voltage (volts)	Approx. Current (amps)
	<b>1.2mm (0.045 in) DC+</b>	
Ar, Ar + He	28	140
	<b>2.4mm (3/32 in) DC-</b>	
Ar	12	110

# SW-625

## Conformances

AWS A5.34/ ASME SFA5.34 ENiCrMo3T1-4  
EN ISO 12153 T Ni 6625 P M 2

## Applications

- Joining nickel-chromium-molybdenum alloys cladding steel with nickel- chromium-molybdenum weld metal LNG storage
- LNG storage tank manufactures
- Desulfurizations
- Heat exchangers

## Features

- Good corrosion resistance to crevice and pitting, SCC
- Good Tensile strength at high temperature
- Good impact value at cryogenic temperature

## Welding Position

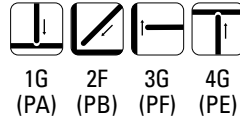

## Current

DC +

## Shielding Gas

Ar + 20% CO<sub>2</sub>

## Diameter / Packaging

Diameter	Spool
mm (in)	12.5kg (27.6lbs)
1.2 (0.045)	√

## Typical Chemical Composition of All-Weld Metal (%)

	C	Si	Mn	P	S	Cr	Ni	Mo	Fe	Nb+Ta
Ar + 20% CO <sub>2</sub>	0.07	0.35	0.29	0.003	0.002	20.7	61.8	9.1	3.5	3.4

## Typical Mechanical Properties of All-Weld Metal

	YS MPa(lbs/in <sup>2</sup> )	TS MPa(lbs/in <sup>2</sup> )	EL (%)	Temp °C(°F)	CVN-Impact Value J (ft.lbs)
As-weld	-	810 (117,000)	36.0	-196 (-321)	60 (44)
PWHT(620°C*8Hr)	-	825 (120,000)	36.4	-196 (-321)	55 (41)

## Typical Operating Procedures

Approx. Current (amps)	
Diameter	1.2mm (0.045) DC +
F&HF	180-220
V-up/OH	120-170

# SW-82 Cored

## Conformances

AWS A5.34/ ASME SFA5.34 ENiCr3T1-1/-4  
EN ISO 12153 T Ni 6082 P M/C 2

## Applications

- Dissimilar welding (stainless steel, heat resisting steel)

## Features

- Designed for welding with 100% CO<sub>2</sub> or Ar+15~25% CO<sub>2</sub> shielding gas
- Excellent all position weldability
- Smooth and stable arc with a fast freezing slag

## Welding Position



1G 2F 3G 4G  
(PA) (PB) (PF) (PE)

## Current

DC +

## Shielding Gas

100% CO<sub>2</sub> / Ar+20~25% CO<sub>2</sub>

## Diameter / Packaging

Diameter mm (in)	Length mm(in)	
	12.5kg (28lbs)	15kg (33lbs)
1.2 (0.045)	✓	✓
1.4 (0.052)		
1.6 (1/16)		

## Typical Chemical Composition of All-Weld Metal(%)

C	Si	Mn	P	S	Cr	Ni	Nb	Fe
0.044	0.21	3.1	0.001	0.004	20.6	71.3	2.42	2.26

## Typical Mechanical Properties of All-Weld Metal

YS MPa(lbs/in <sup>2</sup> )	TS MPa(lbs/in <sup>2</sup> )	EL (%)	Temp °C(°F)	CVN-Impact Value J (ft-lbs)
-	665	42.8	-196 (-321)	100 (74)

## Typical Operating Procedures

Diameter, Polarity Shielding Gas	CTWD mm (in)	Wire Feed Speed m/min (in/min)	Voltage (volts)	Approx. Current (amps)	Deposition Rate kg/hr (lb/hr)
<b>1.2mm (0.045 in) DC+</b>					
100% CO <sub>2</sub>	20 (4/5)	6.0 (236)	23~26	140	2.5 (5.5)
		9.2 (362)	27~30	180	3.4 (7.5)
		12.0 (472)	28~31	210	4.5 (9.9)
80% Ar+20% CO <sub>2</sub>	20 (4/5)	6.1 (240)	23~26	140	2.6 (5.7)
		9.0 (354)	27~30	180	3.6 (7.9)
		11.5 (453)	27~30	210	4.6 (10.1)

SWAW

SAW

GMAW

GTAW

FCAW

Non-FERROUS

APPENDIX

# SW-182 Cored

## Conformances

AWS A5.34/ ASME SFA5.34 ENiCrFe3T1-1/-4  
EN ISO 12153 T Ni 6182 P M/C 2

## Applications

- Dissimilar welding(stainless steel, heat resisting steel)

## Features

- Designed for welding with 100% CO<sub>2</sub> or Ar+15~25% CO<sub>2</sub> shielding gas
- Excellent all position weldability
- Smooth and stable arc with a fast freezing slag

## Welding Position

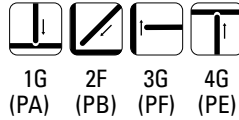

## Current

DC +

## Shielding Gas

100% CO<sub>2</sub> / Ar+20~25% CO<sub>2</sub>

## Diameter / Packaging

Diameter mm (in)	Length mm(in)	
	12.5kg (28lbs)	15kg (33lbs)
1.2 (0.045)	√	√
1.4 (0.052)		
1.6 (1/16)		

## Typical Chemical Composition of All-Weld Metal(%)

C	Si	Mn	P	S	Cr	Ni	Nb	Fe
0.05	0.31	6.22	0.001	0.007	16.0	66.0	1.9	8.6

## Typical Mechanical Properties of All-Weld Metal

YS MPa(lbs/in <sup>2</sup> )	TS MPa(lbs/in <sup>2</sup> )	EL (%)	Temp °C(°F)	CVN-Impact Value J (ft-lbs)
-	640	37	-196 (-321)	100 (74)

## Typical Operating Procedures

Diameter, Polarity Shielding Gas	CTWD mm (in)	Wire Feed Speed m/min (in/min)	Voltage (volts)	Approx. Current (amps)	Deposition Rate kg/hr (lb/hr)
<b>1.2mm (0.045 in) DC+</b>					
100% CO <sub>2</sub>	20 (4/5)	6.0 (236)	23~26	140	2.5 (5.5)
		9.2 (362)	27~30	180	3.4 (7.5)
		12.0 (472)	28~31	210	4.5 (9.9)
80% Ar+20% CO <sub>2</sub>	20 (4/5)	6.1 (240)	23~26	140	2.6 (5.7)
		9.0 (354)	27~30	180	3.6 (7.9)
		11.5 (453)	27~30	210	4.6 (10.1)



# SMT-08

## Conformances

AWS A5.14/ ASME SFA5.14 ERNiMo-8  
 JIS Z3334 SNi1008(NiMo19WCr)  
 KOGAS

## Applications

- LNG storage tanks
- Oxygen, nitrogen and LNG carriers

## Features

- For the automatic welding processes for a LNG storage tank with a methode of GTAW for vertical joints of side plates(ASTM A333,A334,A353,A553)
- Impact toughness at extra low temperature

## Welding Position

## Current

GTAW: DC-(Auto TIG)

## Shielding Gas

Ar

## Diameter / Packaging

Diameter	MIG	TIG
mm (in)	12.5kg (27.6lbs)	5kg (11lbs)
1.2 (0.045)	✓	
2.0 (5/64)		✓
2.4 (3/32)		✓
3.2 (1/8)		✓

## Typical Chemical Composition of All-Weld Metal (%)

C	Si	Mn	P	S	Cr	Ni	Mo	Fe	W
0.015	0.012	0.01	0.002	0.001	2.1	69.8	19.2	5.6	2.6

## Typical Mechanical Properties of All-Weld Metal

YS MPa(lbs/in <sup>2</sup> )	TS MPa(lbs/in <sup>2</sup> )	EL (%)	Temp °C(°F)	CVN-Impact Value J (ft.-lbs)
-	725 (105,000)	38.0	-196 (-321)	150 (111)

## Typical Operating Procedures

Diameter, Polarity Shielding Gas	Voltage (volts)	Approx. Current (amps)
1.2mm (0.045 in) DC-(Auto-TIG)		
Ar	28	160
2.4mm (3/32 in) DC-		
Ar	12	110

SMAW

SAW

GMWAW

GTAW

FCAW

Non-FERROUS

APPENDIX

# SMT-825

## Conformances

AWS A5.14/ ASME SFA5.14 ERNiFeCr-1  
 JIS Z3334 S Ni8065(NiFe30Cr21Mo3)  
 EN ISO 18274 S Ni 8065

## Applications

- Ni-Cr-Mo-Co alloys
- Overlay cladding on similar chemical composition steels

## Features

- Good resistance of corrosion in sulfuric acid and phosphoric acid environment

## Welding Position

### Current

GMAW: DC+(Pulse), GTAW: DC-

### Shielding Gas

Ar, Ar + He

### Diameter / Packaging

Diameter	MIG	TIG
mm (in)	12.5kg (27.6lbs)	5kg (11lbs)
1.0 (0.040)	✓	
1.2 (0.045)	✓	
1.6 (1/16)	✓	
2.0 (5/64)		✓
2.4 (3/32)		✓
3.2 (1/8)		✓

## Typical Chemical Composition of All-Weld Metal (%)

C	Si	Mn	P	S	Cr	Ni	Mo	Fe	Cu	Ti
0.01	0.25	0.45	0.02	0.001	21.5	42.6	3.1	29.0	2.0	1.0

## Typical Mechanical Properties of All-Weld Metal

YS MPa(lbs/in <sup>2</sup> )	TS MPa(lbs/in <sup>2</sup> )	EL (%)	Temp °C(°F)	CVN-Impact Value J (ft.-lbs)
420 (61,000)	610 (88,000)	34.0		

## Typical Operating Procedures

Diameter, Polarity Shielding Gas	Voltage (volts)	Approx. Current (amps)
	1.2mm (0.045 in) DC+	
Ar, Ar + He	28	160
	2.4mm (3/32 in) DC-	
Ar	12	110

# SM-455 / ST-455

## Conformances

AWS A5.14/ ASME SFA5.14 ERNiCrMo-7  
 JIS Z3334 SNI6455(NiCr16Mo16Ti)

## Applications

- Vessel engines
- Heat exchangers
- Offshore oil equipments
- Petrochemical plants
- Suitable for Hastelloy C4,C276

## Features

- Ni based solid filler wire.
- Highly corrosive resistance in reductive, especially in oxidation conditions

## Welding Position

### Current

GMAW: DC+(Pulse), GTAW: DC-

### Shielding Gas

Ar, Ar + He

### Diameter / Packaging

Diameter	MIG	TIG
mm (in)	12.5kg (27.6lbs)	5kg (11lbs)
1.0 (0.040)	✓	
1.2 (0.045)	✓	
1.4 (0.052)	✓	
1.6 (1/16)	✓	
2.0 (5/64)		✓
2.4 (3/32)		✓
3.2 (1/8)		✓

## Typical Chemical Composition of All-Weld Metal (%)

C	Si	Mn	P	S	Cr	Ni	Mo	Fe
0.013	0.05	0.01	0.004	0.003	17.5	65.0	15.0	2.5

## Typical Mechanical Properties of All-Weld Metal

YS MPa(lbs/in <sup>2</sup> )	TS MPa(lbs/in <sup>2</sup> )	EL (%)	Temp °C(°F)	CVN-Impact Value J (ft.-lbs)
-	700 (102,000)	40.0		

## Typical Operating Procedures

Diameter, Polarity Shielding Gas	Voltage (volts)	Approx. Current (amps)
	1.2mm (0.045 in) DC+	
Ar, Ar + He	29	150
	2.4mm (3/32 in) DC-	
Ar	12	110

SMW

SAW

GMAW

GTAW

FCAW

Non-FERROUS

APPENDIX

# SMT-22

## Conformances

AWS A5.14/ ASME SFA5.14 ERNiCrMo-10  
 JIS Z 3324 S Ni6022(NiCr21Mo13Fe4W3)  
 EN ISO 18274 S Ni 6022

## Applications

- FGD, Petrochemical plants Offshore applications
- Inconel 625+601, Hastalloy C-22, Ni alloy steel

## Features

- Good resistance to pitting and crevice corrosion

## Welding Position

### Current

GMAW: DC+(Pulse), GTAW: DC-

### Shielding Gas

Ar, Ar + He

### Diameter / Packaging

Diameter	MIG	TIG
mm (in)	12.5kg (27.6lbs)	5kg (11lbs)
1.0 (0.040)	✓	
1.2 (0.045)	✓	
2.0 (5/64)		✓
2.4 (3/32)		✓
3.2 (1/8)		✓

## Typical Chemical Composition of All-Weld Metal (%)

C	Si	Mn	P	S	Cr	Ni	Mo	W	Fe
0.01	0.06	0.38	0.001	0.001	22.4	55.5	14.2	2.8	4.1

## Typical Mechanical Properties of All-Weld Metal

YS MPa(lbs/in <sup>2</sup> )	TS MPa(lbs/in <sup>2</sup> )	EL (%)	Temp °C(°F)	CVN-Impact Value J (ft.-lbs)
-	720 (104,000)	41.0	-196 (-321)	110 (81)

## Typical Operating Procedures

Diameter, Polarity Shielding Gas	Voltage (volts)	Approx. Current (amps)
	1.2mm (0.045 in) DC+	
Ar, Ar + He	28	160
	2.4mm (3/32 in) DC-	
Ar	12	110

# SM-82 / ST-82

## Conformances

AWS A5.14/ ASME SFA5.14 ERNiCr-3  
 JIS Z3334 SNi6082(NiCr20Mn3Nb)  
 EN ISO 18274 S Ni 6082

## Applications

- LNG and LPG storage plant, Boilers of the thermal power stations
- Ni-based alloys and high temperature alloys

## Features

- Good corrosion-resistant and heat-resistant
- Excellent strength and toughness
- No preheat is required

## Welding Position

### Current

GMAW: DC+(Pulse), GTAW: DC-

### Shielding Gas

Ar, Ar + He

### Diameter / Packaging

Diameter	MIG	TIG
mm (in)	12.5kg (27.6lbs)	5kg (11lbs)
1.0 (0.040)	✓	
1.2 (0.045)	✓	
1.4 (0.052)	✓	
1.6 (1/16)	✓	
2.0 (5/64)		✓
2.4 (3/32)		✓
3.2 (1/8)		✓

## Typical Chemical Composition of All-Weld Metal (%)

C	Si	Mn	P	S	Cr	Ni	Nb+Ta
0.04	0.1	3.2	0.006	0.001	20.0	73.0	2.5

## Typical Mechanical Properties of All-Weld Metal

YS MPa(lbs/in <sup>2</sup> )	TS MPa(lbs/in <sup>2</sup> )	EL (%)	Temp °C(°F)	CVN-Impact Value J (ft.-lbs)
-	660 (96,000)	35.0	-196 (-321)	80 (59)

## Typical Operating Procedures

Diameter, Polarity Shielding Gas	Voltage (volts)	Approx. Current (amps)
	1.2mm (0.045 in) DC+	
Ar, Ar + He	28	180
	2.4mm (3/32 in) DC-	
Ar	12	110

SMW

SAW

GMAW

GTAW

FCAW

Non-FERROUS

APPENDIX

# SM-276 / ST-276

## Conformances

AWS A5.14/ ASME SFA5.14 ERNiCrMo-4  
 JIS Z3334 SNi6276(NiCr15Mo16Fe6W4)  
 EN ISO 18274 S Ni 6276

## Applications

- LNG and LPG storage plant, Boilers of the thermal power station
- Aggressive environments in chemical process plants

## Features

- Good corrosion-resistant
- No preheat is required
- Interpass temperature should preferably be kept below 100°C and input restricted to 1.5KJ/Min

## Welding Position

### Current

GMAW: DC+(Pulse), GTAW: DC-

### Shielding Gas

Ar, Ar + He

### Diameter / Packaging

Diameter	MIG	TIG
mm (in)	12.5kg (27.6lbs)	5kg (11lbs)
1.0 (0.040)	✓	
1.2 (0.045)	✓	
1.4 (0.052)	✓	
1.6 (1/16)	✓	
2.0 (5/64)		✓
2.4 (3/32)		✓
3.2 (1/8)		✓

## Typical Chemical Composition of All-Weld Metal (%)

C	Si	Mn	P	S	Cr	Ni	Mo	W
0.01	0.05	0.5	0.003	0.01	15.0	57.0	16.0	4.0

## Typical Mechanical Properties of All-Weld Metal

YS MPa(lbs/in <sup>2</sup> )	TS MPa(lbs/in <sup>2</sup> )	EL (%)	Temp °C(°F)	CVN-Impact Value J (ft.-lbs)
-	750 (109,000)	33.0		

## Typical Operating Procedures

Diameter, Polarity Shielding Gas	Voltage (volts)	Approx. Current (amps)
	1.2mm (0.045 in) DC+	
Ar, Ar + He	28	160
	2.4mm (3/32 in) DC-	
Ar	12	110

# SM-400 / ST-400

## Conformances

AWS A5.14/ ASME SFA5.14 ERNiCu-7  
 JIS Z3334 S Ni4060(NiCu30Mn3Ti)  
 EN ISO 18274 S Ni 4060

## Applications

- Heat exchanger
- Piping and Vessels
- Salt purification

## Features

- No Preheat required, maximum interpass temperature 150°C and no PWHT required

## Welding Position

### Current

GMAW: DC+(Pulse), GTAW: DC-

### Shielding Gas

Ar, Ar + He

### Diameter / Packaging

Diameter	MIG	TIG
mm (in)	12.5kg (27.6lbs)	5kg (11lbs)
1.0 (0.040)	✓	
1.2 (0.045)	✓	
1.4 (0.052)	✓	
1.6 (1/16)	✓	
2.0 (5/64)		✓
2.4 (3/32)		✓
3.2 (1/8)		✓

## Typical Chemical Composition of All-Weld Metal (%)

C	Si	Mn	P	S	Ni	Cu	Ti	Fe
0.04	0.20	3.5	0.005	0.001	64.0	28.5	2.2	0.9

## Typical Mechanical Properties of All-Weld Metal

YS MPa(lbs/in <sup>2</sup> )	TS MPa(lbs/in <sup>2</sup> )	EL (%)	Temp °C(°F)	CVN-Impact Value J (ft.-lbs)
-	530 (77,000)	45.0	-	-

## Typical Operating Procedures

Diameter, Polarity Shielding Gas	Voltage (volts)	Approx. Current (amps)
	1.2mm (0.045 in) DC+	
Ar, Ar + He	29	150
	2.4mm (3/32 in) DC-	
Ar	12	110

SMW

SAW

GMAW

GTAW

FCAW

Non-FERROUS

APPENDIX

# SM-718 / ST-718

## Conformances

AWS A5.14/ ASME SFA5.14 ERNiFeCr-2  
 JIS Z3334 SNi7718(NiCr19Fe19Nb5Mo3)  
 EN ISO 18274 S Ni 7718

## Applications

- High-strength aircraft components
- Spindles of ship-building, engines
- Jet engine parts
- Nuclear power plants involving cryogenic temperatures

## Features

- Precautions should be taken with high input processes to avoid microfissuring

## Welding Position

### Current

GMAW: DC+(Pulse), GTAW: DC-

### Shielding Gas

Ar, Ar + He

### Diameter / Packaging

Diameter	MIG	TIG
mm (in)	12.5kg (27.6lbs)	5kg (11lbs)
1.0 (0.040)	✓	
1.2 (0.045)	✓	
1.4 (0.052)	✓	
1.6 (1/16)	✓	
2.0 (5/64)		✓
2.4 (3/32)		✓
3.2 (1/8)		✓

## Typical Chemical Composition of All-Weld Metal (%)

C	Si	Mn	P	S	Cr	Ni	Mo	Fe	Nb	Ti
0.06	0.10	0.15	0.004	0.001	19.0	53.0	3.10	17.5	5.05	1.0

## Typical Mechanical Properties of All-Weld Metal

YS MPa(lbs/in <sup>2</sup> )	TS MPa(lbs/in <sup>2</sup> )	EL (%)	Temp °C(°F)	CVN-Impact Value J (ft-lbs)
630 (91,000)	860 (125,000)	27.0	-	-

## Typical Operating Procedures

Diameter, Polarity Shielding Gas	Voltage (volts)	Approx. Current (amps)
	1.2mm (0.045 in) DC+	
Ar, Ar + He	28	180
	2.4mm (3/32 in) DC-	
Ar	12	110



# SM-60 / ST-60

## Conformances

AWS A5.14/ ASME SFA5.14 ERNi-1  
 JIS Z3334 SNi2061(NiTi3)  
 EN ISO 18274 S Ni 2061

## Applications

- Salt Production line
- Cast irons to give soft low strength deposit
- Dissimilar welding and buffer layers

## Features

- Heavy multipass deposits or highly restrained joints may require preheatup to 150°C

## Welding Position

### Current

GMAW: DC+(Pulse), GTAW: DC-

### Shielding Gas

Ar, Ar + He

### Diameter / Packaging

Diameter	MIG	TIG
mm (in)	12.5kg (27.6lbs)	5kg (11lbs)
1.0 (0.040)	✓	
1.2 (0.045)	✓	
1.4 (0.052)	✓	
1.6 (1/16)	✓	
2.0 (5/64)		✓
2.4 (3/32)		✓
3.2 (1/8)		✓

## Typical Chemical Composition of All-Weld Metal (%)

C	Si	Mn	P	S	Ni	Ti
0.02	0.40	0.4	0.005	0.001	96.0	3.0

## Typical Mechanical Properties of All-Weld Metal

YS MPa(lbs/in <sup>2</sup> )	TS MPa(lbs/in <sup>2</sup> )	EL (%)	Temp °C(°F)	CVN-Impact Value J (ft.-lbs)
	480 (70,000)	30.0	-	-

## Typical Operating Procedures

Diameter, Polarity Shielding Gas	Voltage (volts)	Approx. Current (amps)
	1.2mm (0.045 in) DC+	
Ar, Ar + He	29	150
	2.4mm (3/32 in) DC-	
Ar	12	110

SMW

SAW

GMAW

GTAW

FCAW

Non-FERROUS

APPENDIX

# SMT-7030

## Conformances

AWS A5.7/ ASME SFA5.7 ERCuNi  
 JIS Z3341 YCuNi-3  
 ABS AWS A5.7 ERCuNi

## Applications

- Desalination plant
- Evaporators and etc in salt and sea water processing system

## Features

- No preheat & PWHT required, maximum interpass temperature 150°C
- Contamination of the weld zone with foreign material, particularly any source of lead, tin or zinc must be scrupulously avoided to prevent weld metal cracking

## Welding Position

### Current

GMAW: DC+(Pulse), GTAW: DC-

### Shielding Gas

Ar, Ar + He

### Diameter / Packaging

Diameter	MIG	TIG
mm (in)	12.5kg (27.6lbs)	5kg (11lbs)
1.0 (0.040)	✓	
1.2 (0.045)	✓	
1.4 (0.052)	✓	
1.6 (1/16)	✓	
2.0 (5/64)		✓
2.4 (3/32)		✓
3.2 (1/8)		✓

## Typical Chemical Composition of All-Weld Metal (%)

C	Si	Mn	P	S	Ni	Ti	Cu	Fe
0.02	0.10	0.8	0.001	0.001	31.0	0.4	67.0	0.6

## Typical Mechanical Properties of All-Weld Metal

YS MPa(lbs/in <sup>2</sup> )	TS MPa(lbs/in <sup>2</sup> )	EL (%)	Temp °C(°F)	CVN-Impact Value J (ft·lbs)
-	500 (73,000)	30.0		

## Typical Operating Procedures

Diameter, Polarity Shielding Gas	Voltage (volts)	Approx. Current (amps)
	1.2mm (0.045 in) DC+	
Ar, Ar + He	28	160
	2.4mm (3/32 in) DC-	
Ar	12	110

# SM-9010 / ST-9010

## Conformances

JIS Z3341 YCuNi-1  
KR KS D7044 YCuNi-1

## Applications

- Desalination plant
- Offshore applications for ship building in the chemical industry

## Features

- No preheat & PWHT required, maximum interpass temperature 150°C
- Contamination of the weld zone with foreign material, particularly any source of lead, tin or zinc must be scrupulously avoided to prevent weld metal cracking

## Welding Position

### Current

GMAW: DC+(Pulse), GTAW: DC-

### Shielding Gas

Ar, Ar + He

### Diameter / Packaging

Diameter	MIG	TIG
mm (in)	12.5kg (27.6lbs)	5kg (11lbs)
1.0 (0.040)	✓	
1.2 (0.045)	✓	
1.4 (0.052)	✓	
1.6 (1/16)	✓	
2.0 (5/64)		✓
2.4 (3/32)		✓
3.2 (1/8)		✓

## Typical Chemical Composition of All-Weld Metal (%)

C	Si	Mn	P	S	Ni	Ti	Cu	Fe
0.01	0.01	0.85	0.006	0.001	10.6	0.27	Rem	1.0

## Typical Mechanical Properties of All-Weld Metal

YS MPa(lbs/in <sup>2</sup> )	TS MPa(lbs/in <sup>2</sup> )	EL (%)	Temp °C(°F)	CVN-Impact Value J (ft.-lbs)
-	380 (55,000)	36.0		

## Typical Operating Procedures

Diameter, Polarity Shielding Gas	Voltage (volts)	Approx. Current (amps)
	1.2mm (0.045 in) DC+	
Ar, Ar + He	28	160
	2.4mm (3/32 in) DC-	
Ar	12	110

SMW

SAW

GMAW

GTAW

FCAW

Non-FERROUS

APPENDIX

# Superflux300 X SA-82

## Conformances

## Applications

- Structures in extremely low temperature environment
- Boilers of steam power plants

## Features

- Dry the flux at 250~300°C for 60 minutes before use.
- Keep the welding current and heat input as low as possible to prevent HAZ from falling corrosion resistance.
- No preheat required and maximum interpass of 250°C.
- When welding superaustenitic alloys, the interpass temperature should be controlled to a maximum of 100°C

## Welding Position

## Current

DC +

## Diameter / Packaging

Diameter	Spool
mm (in)	25kg (55lbs)
2.0 (5/64)	✓
2.4 (3/32)	✓
3.2 (1/8)	✓

## Typical Chemical Composition of All-Weld Metal (%)

C	Si	Mn	P	S	Cr	Ni
0.067	0.22	3.33	0.001	0.014	19.6	69.8

## Typical Mechanical Properties of All-Weld Metal

YS MPa(lbs/in <sup>2</sup> )	TS MPa(lbs/in <sup>2</sup> )	EL (%)	Temp °C(°F)	CVN-Impact Value J (ft.lbs)
-	619 (90,000)	46.4	-196 (-321)	117 (86)

## Typical Operating Procedures

Wire Feed Speed m/min (in/min)	Voltage (volts)	Approx. Current (amps)
3.2mm (1/8 in) DC+		
36	30	380

# S-Ni2 X SA-08

## Conformances

## Applications

- LNG storage tanks
- Liquid nitrogen storage tanks

## Features

- Dry the flux at 300~350°C for 60 minutes before use

## Welding Position

## Current

DC +

## Diameter / Packaging

Diameter	Spool
mm (in)	25kg (55lbs)
2.0 (5/64)	
2.4 (3/32)	✓
3.2 (1/8)	

## Typical Chemical Composition of All-Weld Metal (%)

C	Si	Mn	P	S	Cr	Ni	Mo	W	Al
0.04	0.2	0.5	0.001	0.001	2.0	66.0	19.0	2.5	0.2

## Typical Mechanical Properties of All-Weld Metal

YS MPa(lbs/in <sup>2</sup> )	TS MPa(lbs/in <sup>2</sup> )	EL (%)	Temp °C(°F)	CVN-Impact Value J (ft-lbs)
420 (61,000)	680 (99,000)	43.0	-196 (-321)	100 (74)

- Base Metal: 9% Ni

## Typical Operating Procedures

Wire Feed Speed m/min (in/min)	Voltage (volts)	Approx. Current (amps)	
2.4mm (3/32 in) DC+			
30~70	24~28	300~380	Horizontal Butt

SMW

SAW

GMAW

GTAW

FCAW

Non-FERROUS

APPENDIX

# SW-625 Cored

## Conformances

AWS A5.34/ ASME SFA5.34 ENiCrMo3T1-1/-4  
EN ISO 12153 T Ni 6625 P M/C 2

## Applications

- Joining nickel-chromium-molybdenum alloys
- Cladding steel with nickel-chromium-molybdenum weld metal
- LNG storage tank manufacture, desulfurization

## Features

- Designed for welding with 100% CO<sub>2</sub> or Ar+15~25% CO<sub>2</sub> shielding gas
- Excellent all position weldability
- Smooth and stable arc with a fast freezing slag

## Welding Position

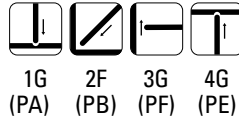

## Current

DC +

## Shielding Gas

100% CO<sub>2</sub> / Ar+20~25% CO<sub>2</sub>

## Diameter / Packaging

Diameter mm (in)	Length mm(in)	
	12.5kg (28lbs)	15kg (33lbs)
1.2 (0.045)	√	√
1.4 (0.052)		
1.6 (1/16)		

## Typical Chemical Composition of All-Weld Metal(%)

C	Si	Mn	P	S	Cr	Ni	Mo	Nb	Fe
0.024	0.42	0.34	0.004	0.002	20.9	65.0	8.9	3.4	0.5

## Typical Mechanical Properties of All-Weld Metal

YS MPa(lbs/in <sup>2</sup> )	TS MPa(lbs/in <sup>2</sup> )	EL (%)	Temp °C(°F)	CVN-Impact Value J (ft-lbs)
-	759	40.4	-196 (-321)	65 (48)

## Typical Operating Procedures

Diameter, Polarity Shielding Gas	CTWD mm (in)	Wire Feed Speed m/min (in/min)	Voltage (volts)	Approx. Current (amps)	Deposition Rate kg/hr (lb/hr)
<b>1.2mm (0.045 in) DC+</b>					
100% CO <sub>2</sub>	20 (4/5)	6.0 (236)	23~26	140	2.5 (5.5)
		9.2 (362)	27~30	180	3.4 (7.5)
		12.0 (472)	28~31	210	4.5 (9.9)
80% Ar+20% CO <sub>2</sub>	20 (4/5)	6.1 (240)	23~26	140	2.6 (5.7)
		9.0 (354)	27~30	180	3.6 (7.9)
		11.5 (453)	27~30	210	4.6 (10.1)

# APPENDIX

Welding symbol	• 492
The Description of Welded Joint Category	• 505
The calculation method of welding materials demand	• 510
The essentials of welding work	• 514
Storage and handling instructions	• 556
Welding Standard Code	• 562
AWS Classification System	• 563
EN Classification System	• 588
Standards of welding consumables	• 594
Reference Material	• 598
Approvals	• 614
Recommendation on HYUNDAI WELDING consumable	• 628
Industries	• 631
HYUNDAI BALL PAC	• 640
PAK Series	• 642
HYUNDAI Standard Packing	• 646
Warning for Safety in Welding	• 656

# Welding symbol

## 1 Indicated position

- The case that the weld zone is opposite direction of the arrow

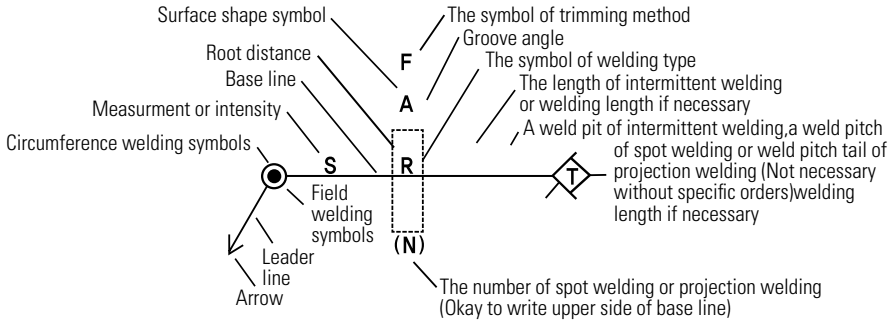



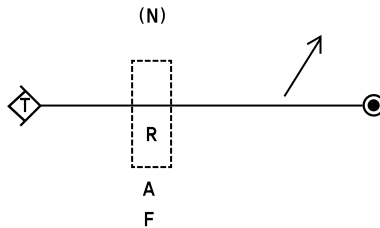









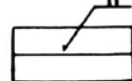

- The case that the weld zone is the same direction of the arrow

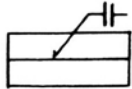
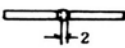
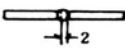

## 2 Welding symbol

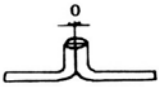
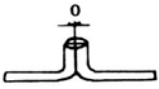

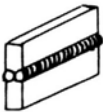

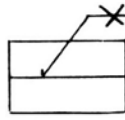
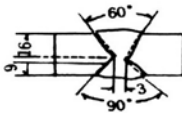
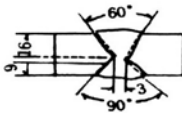
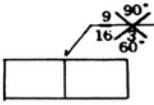
	Welding Type	Symbol	Welding Type	Symbol	Classification	Sub Symbol	
Groove Weld	I type		V type	∨	Surface Shape	Flat	—
	X type	×	U type	∩		Convexity	⌒
	H type	⊗	✓ type	∨		Concavity	⌒
	J type	└	K type	⌒	Finishing Method	Grinder	G
Both side J type	⌒	Flare ✓ type	∩	Machinery		M	
Fillet	Consecutiveness	⌒	Non-consecutiveness	⌒	Chipping	C	
	Cross	⊗			Finishing	F	



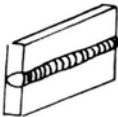
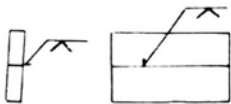
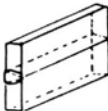
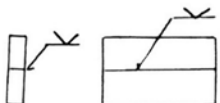
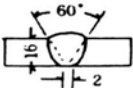
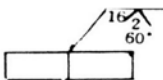
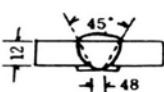
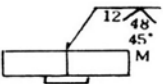
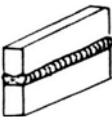
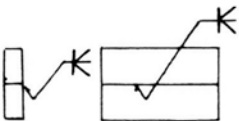
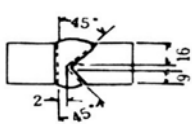
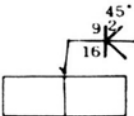
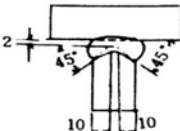
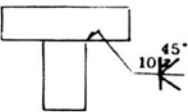

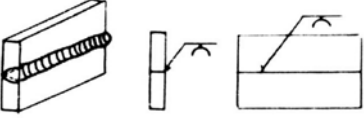
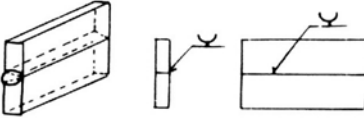
I Type Groove Welding	Symbol		
Weld zone	Real shape		The mark of floor plan
Arrow side			
The opposite side of arrow			
Both side			
Root gap 2mm			
Root gap 2mm			
Root gap 0mm			
X Type Groove Welding	Symbol	×	angle 90°, 4side symmetry
Both side			
Groove depth Arrow side 6mm The opposite side of arrow 9mm Groove angle Arrow side 60° The opposite side of arrow 90° Root gap 3mm			

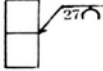
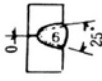
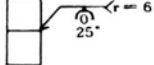

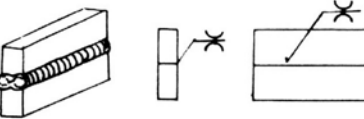
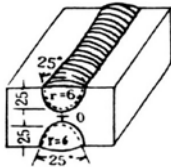
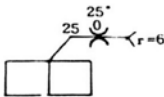
# Welding symbol

V Type Groove Welding	Symbol		angle 90°, 4side symmetry
Weld zone	Real shape		The mark of floor plan
Arrow side			
The opposite side of arrow			
Groove depth 16mm Groove angle 60° Root gap 2mm			
The thickness of the board which uses a base plate Groove angle 45° Root gap 4.8 Mm Finishing method cutting			
K Type Groove Welding	Symbol	K	
Both side			
Arrow side Groove depth 16mm Groove angle 60° Opposite side of arrow Groove depth 9mm Groove angle 45° Root gap 2mm			
T-connection root gap 2mm Groove depth 10mm Groove angle 45° Root gap 2mm			

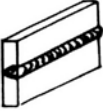
U Type Groove Welding	Symbol		Half circle and straight line (1/2 length of half circle)
Weld zone	Real shape		The mark of floor plan
Arrow side			
The opposite side of arrow			
Groove depth 27mm			
Groove angle 60° Root radius 6mm Root gap 2mm			
H Type Groove Welding	Symbol		
Both side			
Groove depth 25mm Groove angle 25° Root radius 6mm Root gap 0mm			

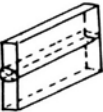
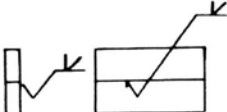
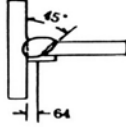
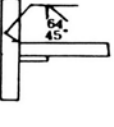
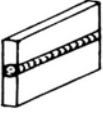
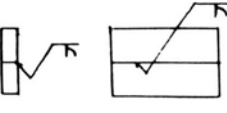
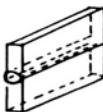
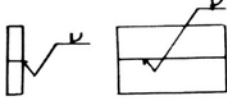
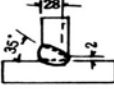
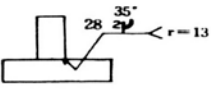
# Welding symbol

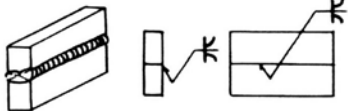
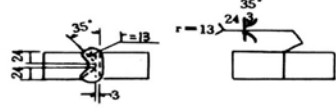

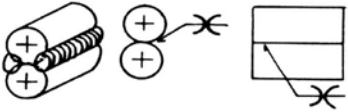









✓ (Bevel) Type Groove Welding	Symbol	✓	A vertical line across with other line, 45° angle between two lines, same height
Weld zone	Real shape		The mark of floor plan
Arrow side			
The opposite side of arrow			
Using t-joint base plate Groove angle 45° Root gap 6.4Mm			
J Type Groove Welding	Symbol	J	A vertical line with a quarter circle and the length of straight part is half of radius
Arrow side			
The opposite side of arrow			
Groove depth 28mm Groove angle 35° Root radius 13mm Root gap 2mm			

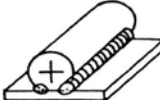
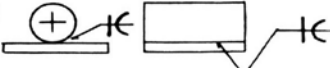

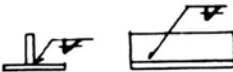
Both side J Type Groove Welding	Symbol	K	
Weld zone	Real shape		The mark of floor plan
Both side			
Groove depth 27mm Groove angle 35° Root radius 13mm Root gap 3mm			
Flare V and Flare X Type Groove Welding	Symbol	K	Flare V type is that 2 quarter circles face back together Flare X type is that 2 half circles face back together
Arrow side			
The opposite side of arrow			
Both side			

SMAW  
 SAW  
 GMAW  
 GTAW  
 FCAW  
 Non-FERROUS



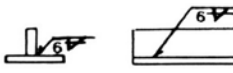

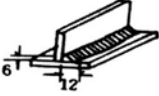
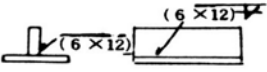
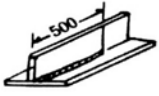
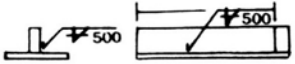
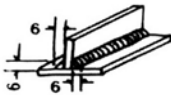
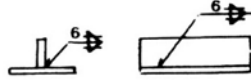
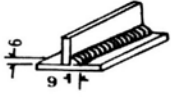
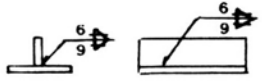

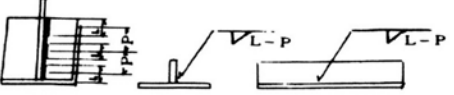
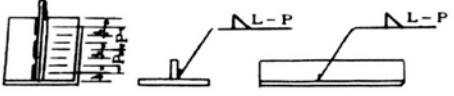
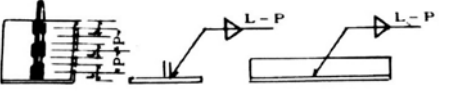
APPENDIX

# Welding symbol



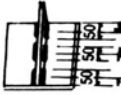
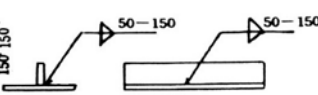
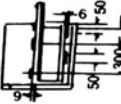
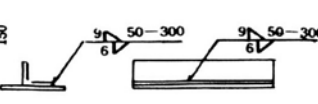
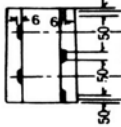
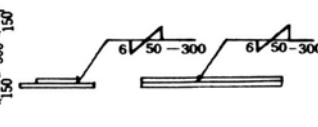

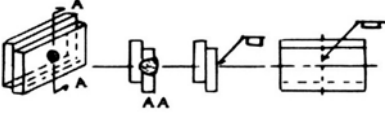
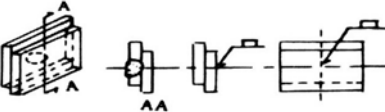
Flare V and Flare K Type Groove Welding	Symbol		Flare V type : a vertical line with a quarter circle Flare K type : a vertical line with a half circle
Weld zone	Real shape		The mark of floor plan
Arrow side			
The opposite side of arrow			
Both side			
Fillet Welding	Symbol		right-angled isosceles triangle, one horizontal line from the median point of the perpendicular line
Arrow side			
The opposite side of arrow			
Both side			
The length of leg: 6mm			

Fillet Welding	Symbol		right-angled isosceles triangle, one horizontal line from the median point of the perpendicular line
Weld zone	Real shape		The mark of floor plan
The length of leg: 6mm X 12mm			
The length of welding: 500mm			
The length of both side of legs: 6mm			
Different length of both side of legs			
Fillet Welding	Symbol	Parallel 	Zigzag 
Arrow side			
The opposite side of arrow			
Both side			

# Welding symbol

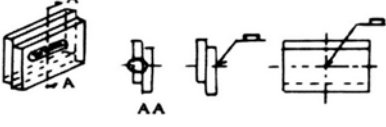
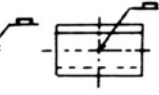
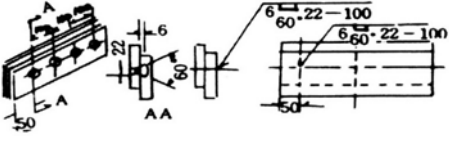
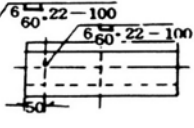
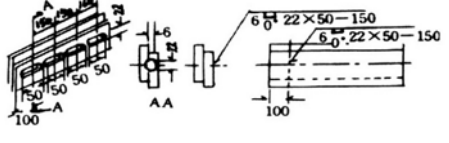
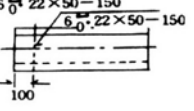

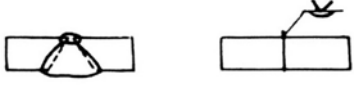

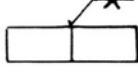
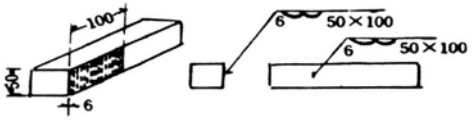
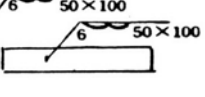
Fillet Welding		Symbol	Parallel 	Zigzag 	
Weld zone		Real shape		The mark of floor plan	
The parallel welding Weld length 50mm Weld pitch : 150mm					
The length of leg in front of the crossed weld arrow : 6mm The length of the opposite side leg of arrow : 9mm Weld length 50mm Weld pitch : 300mm					
The length of both side legs of the crossed weld arrow : 6mm Weld length: 50mm Weld pitch : 300mm					
Fillet Welding		Symbol		an upside-down isosceles trapezoid, the length of lower base is 1/2 of the upper one	
Groove type	Arrow side				
	The opposite side of arrow				
Circle type	Arrow side				



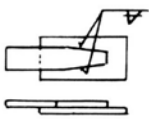
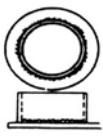

Flux Welding		Symbol		an upside-down isosceles trapezoid, the length of lower base is 1/2 of the upper one
Weld zone		Real shape		The mark of floor plan
Groove type	The opposite side of arrow			
Circle type	Hole diameter : 22mm Weld pitch : 100mm Groove angle : 60c° Weld length : 6mm			
Groove type	Hole diameter : 22mm Weld pitch : 50mm Groove angle : 0c° Weld length : 6mm			
Bead or Built Up Welding		Symbol		the height of arc is 1/2 of radius, in case of built up welding, put two of them in a row
Arrow side				
The opposite side of arrow				
The thickness of built-up welds : 6mm Width 50mm Length : 300mm				

SMAW  
SAW  
GMAW  
GTAW  
FCAW  
Non-FERROUS  
APPENDIX

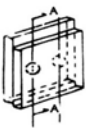
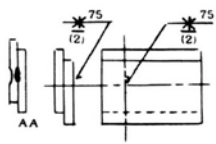
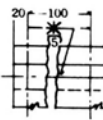
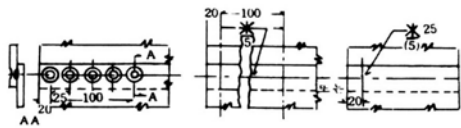



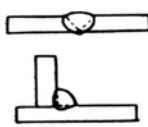
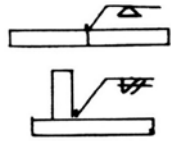
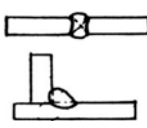
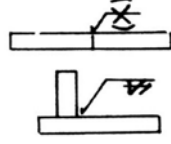
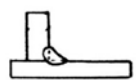
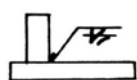
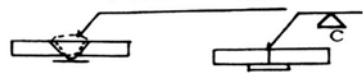
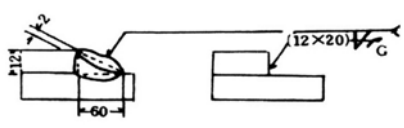
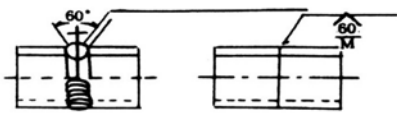



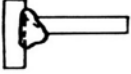
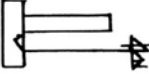
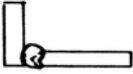

# Welding symbol

Fillet Welding	Symbol	Field Welding •	Circular-Patch Welding ○	Circular-Patch Field Welding ⊙
Weld zone	Real shape		The mark of floor plan	
In case of field fillet welding				
In case of circular-patch sequential fillet welding				
In case of sequential circular-patch field fillet welding				
Spot Welding	Symbol	✱		
Using smooth electrode on the arrow side				
				

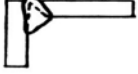
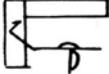
The Welding Surface Phenomenon	Symbol	Convex 	Concave 	Flatness 
Weld zone		Real shape	The mark of floor plan	
In the case that the surface of butt welding and fillet welding are flat				
In the case that the surface of butt welding and fillet welding are flat				
In the case that the surface of fillet welding is concave				
Finishing Method	Symbol	Chipping C	Grinding G	Cutting M
In case of finish of chipping on the butt weld zone				
Finish of grinding on the scalene fillet weld zone and make it 2mm concave shape				
Finish of cutting on the butt weld zone of circle plank, omit the sub-symbol because it obviously is circular-patch				

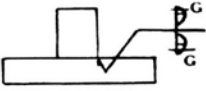
# Welding symbol

## Combination use of symbol

Flux Welding	Symbol		an upside-down isosceles trapezoid, the length of lower base is 1/2 of the upper one
Weld zone		Real shape	The mark of floor plan
The combination of bead and bevel groove welding			
The combination of bevel groove and fillet welding			
The combination of K type welding and fillet welding			
The combination of J type, fillet and bead welding			
The combination of both side J type, fillet welding, finish grinding symbol and concave symbol			
Projection Welding	Symbol		
Arrow side			
The opposite side of arrow			

# The Description of Welded Joint Category

Picture 1 Joint shape

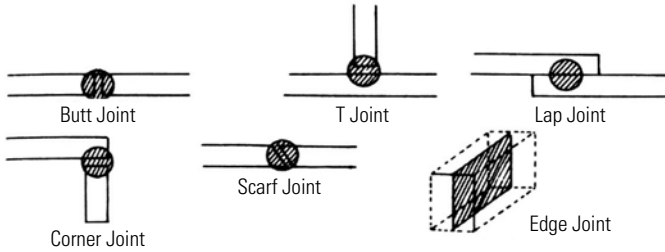

Picture 2 Groove shape

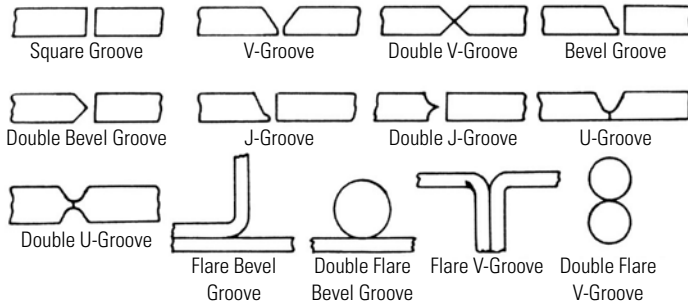

Picture 3 The definition of groove term

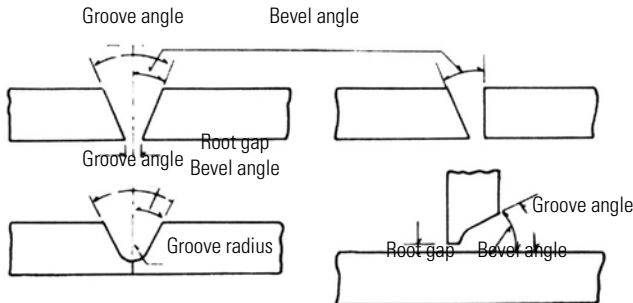

SMW

SAW

GMW

GTAW

FCW

Non-FERROUS

APPENDIX

# The Description of Welded Joint Category

Picture 4 Joint shape

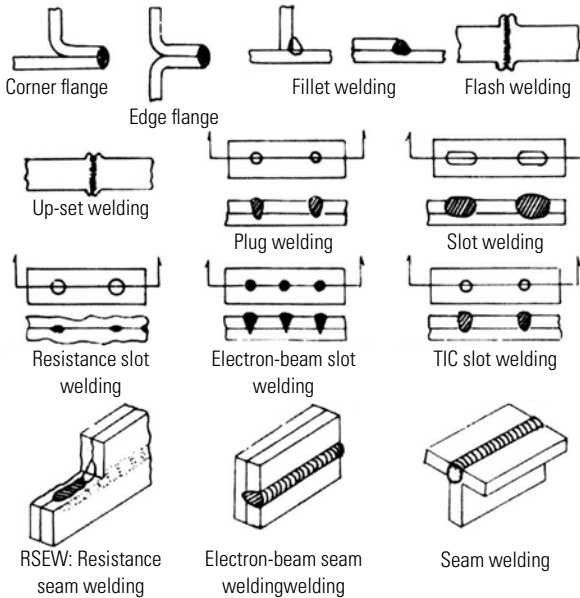

Picture 5 The definition of fillet welding term

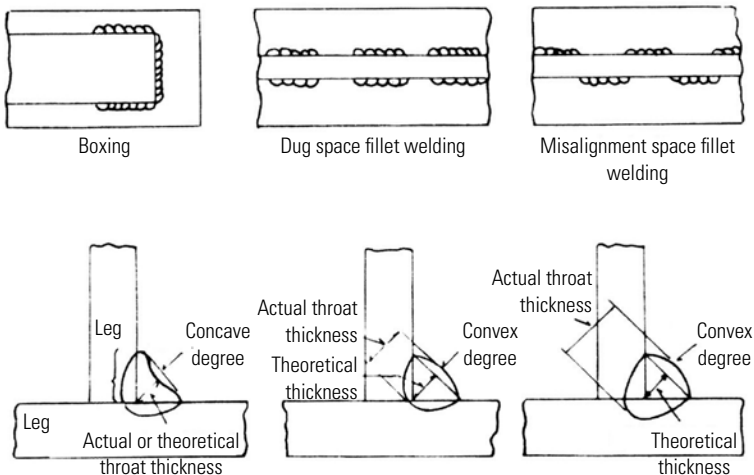

**Picture 6** The definition of welding term

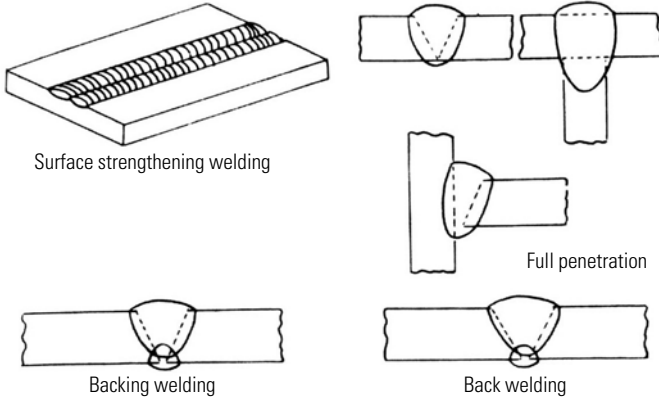

**Picture 7** The definition of joint term

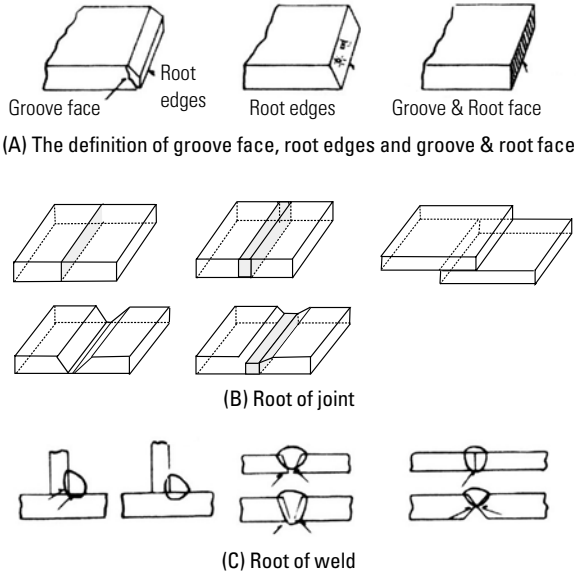

# The Description of Welded Joint Category

**Picture 8** The definition of welding term

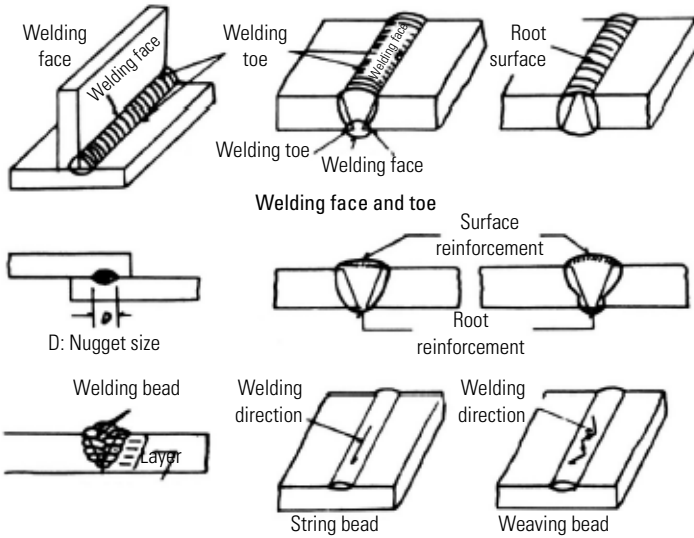

**Picture 9** Weld penetration and weld zone size

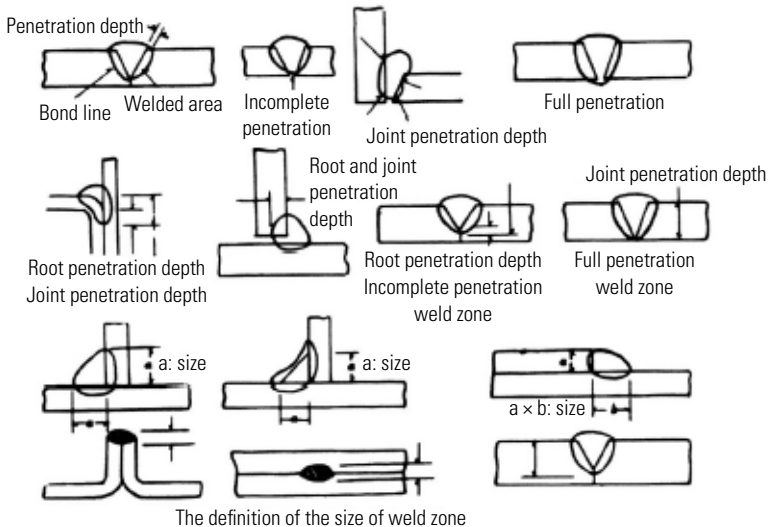



Picture 10 Weld defects

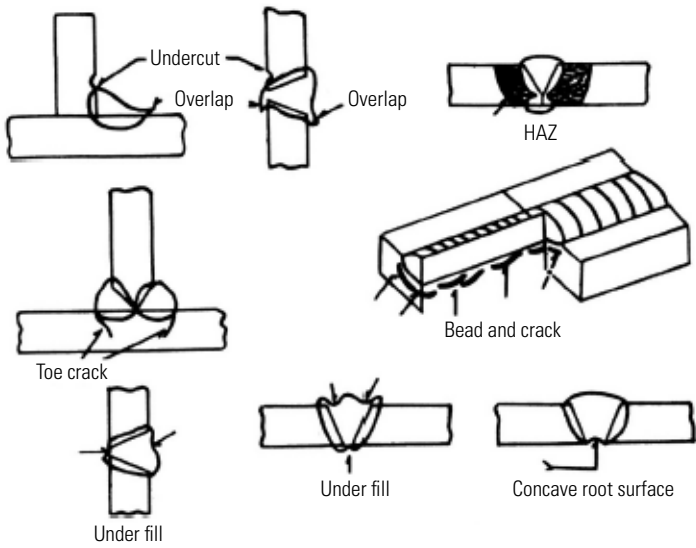

SM/W

SAW

GM/W

GT/W

FC/W

Non-FERROUS

APPENDIX

# The calculation method of welding materials demand

## 1 Calculation method of materials demand

The weight of deposited weld metal( $W_D$ ) =  $(A+B) \times L \times \rho$  ..... (1)

The weight of deposited weld metal( $W_D$ ) =  $W \times \eta$  ..... (2)

According to (1) and (2), the welding materials demand could be calculated with the following equation.

$$W(\text{gr}) = \frac{(A+B) \times \rho}{\eta} \times L$$

**Attention:**

A: cross selection of groove( $\text{cm}^2$ )

B: cross selection of built-up( $\text{cm}^2$ )

L: welding length( $\text{cm}$ )

$\rho$ : the proportion of deposited weld metal

$\eta$ : deposition efficiency( $\frac{\%}{100}$ )

The materials demand could be calculated on the supposition that the following statement (including deposition efficiency, build-up amount and the proportion). Moreover, please beware that there could be a little difference between the calculation result and actual demand.

- Reinforcement amount: 20% of the cross sectional area

- Deposition efficiency

Submerged Arc Welding	99%
Gas Metal Arc Welding(98%Ar/2%O <sub>2</sub> )	98%
Gas Metal Arc Welding(75%Ar/25%CO <sub>2</sub> )	96%
Gas Metal Arc Welding(CO <sub>2</sub> )	93%
Metal Cored Wires	93%
Gas Shielded Flux Cored Wires	85%
Self Shielded Flux Cored Wires	82%
Shielded Metal Arc Welding	55%(except 50mm at Holded area)

- Proportion: Mild Steel 7.85

Stainless Steel 304 8.02

Stainless Steel 316 7.94

## 2 The demand of standard joint and welding materials

The following is the calculation of mild steel flux cored wire demand per 1m of welding length

### (1) In case of Fillet welding

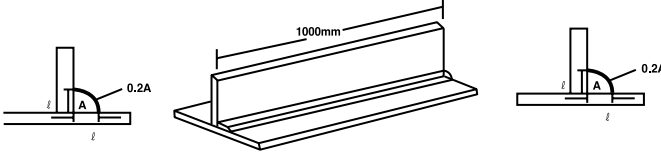

The amount of CO<sub>2</sub> flux cored wire for the fillet welding

Leg length (mm)	Demand quantity (kg/m)	Leg length (mm)	Demand quantity (kg/m)	Note
4	0.089	10	0.554	The following is the equation $W(\text{gr/m}) = 5.54\varrho^2$ $W(\text{gr/m}) = 5.54\varrho^2$ [ϱ : Leg length(mm)]
5	0.139	11	0.670	
6	0.199	12	0.798	
7	0.271	13	0.936	
8	0.355	14	1.086	
9	0.449	15	1.247	

### (2) In case of a butt welding

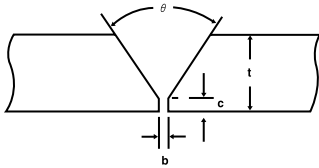

$\theta$	$\tan \frac{\theta}{2}$
45°	0.414
50°	0.466
60°	0.577
70°	0.700

$$W = \frac{\{(b \times t) + (t - c)^2 \tan \frac{\theta}{2}\} \times 1.2 \times \rho}{\eta} \times L$$

In case of CO<sub>2</sub> flux cored wire:

$$W(\text{gr/m}) = 11.08 \{ bt + (t - c)^2 \tan \frac{\theta}{2} \}$$

(The unit of b, c, t is mm)

#### Reference:

- In case of coated electrode  $W(\text{gr/m}) = 17.13 \{ bt + (t - c)^2 \tan \frac{\theta}{2} \}$
- In case of CO<sub>2</sub> solid wire  $W(\text{gr/m}) = 10.13 \{ bt + (t - c)^2 \tan \frac{\theta}{2} \}$

# The calculation method of welding materials demand

## 3 The demand quantity of welding rod when V-type Butt welding (Kg/m)

Plate Thickness (mm)	In Case of Coated Electrodes						Plate Thickness (mm)	In Case of CO <sub>2</sub> Flux Cored Wire							
	(θ°)	c(mm) b(mm)	0	1	2	3		4	(θ°)	c(mm) b(mm)	0	1	2	3	4
6	45	0	0.26	0.18	0.11	0.06	0.03	6	45	0	0.17	0.11	0.07	0.04	0.02
		1	0.36	0.28	0.22	0.17	0.13			1	0.23	0.18	0.14	0.11	0.08
		2	0.46	0.38	0.32	0.27	0.23			2	0.30	0.25	0.21	0.17	0.15
		3	0.56	0.49	0.42	0.37	0.34			3	0.36	0.31	0.27	0.24	0.22
		4	0.67	0.59	0.52	0.47	0.44			4	0.43	0.38	0.34	0.31	0.28
		5	0.77	0.69	0.63	0.58	0.56			5	0.50	0.45	0.41	0.37	0.35
	60	0	0.36	0.25	0.16	0.09	0.04	60	0	0.23	0.11	0.07	0.04	0.02	
		1	0.46	0.35	0.26	0.19	0.14		1	0.30	0.18	0.14	0.11	0.08	
		2	0.56	0.45	0.36	0.29	0.25		2	0.36	0.25	0.21	0.17	0.15	
		3	0.66	0.56	0.47	0.40	0.35		3	0.43	0.31	0.27	0.24	0.22	
		4	0.77	0.66	0.57	0.50	0.45		4	0.50	0.38	0.34	0.31	0.28	
		5	0.87	0.76	0.67	0.60	0.55		5	0.56	0.45	0.41	0.37	0.35	
9	45	0	0.57	0.45	0.35	0.26	0.18	9	45	0	0.37	0.29	0.22	0.17	0.11
		1	0.73	0.61	0.50	0.41	0.33			1	0.47	0.39	0.32	0.26	0.21
		2	0.88	0.76	0.66	0.56	0.49			2	0.57	0.49	0.42	0.36	0.31
		3	1.04	0.92	0.81	0.72	0.64			3	0.67	0.59	0.52	0.46	0.41
		4	1.19	1.07	0.96	0.87	0.79			4	0.77	0.69	0.62	0.56	0.51
		5	1.35	1.22	1.12	1.03	0.95			5	0.87	0.79	0.72	0.66	0.61
	60	0	0.80	0.63	0.48	0.26	0.18	60	0	0.52	0.41	0.31	0.17	0.11	
		1	0.95	0.79	0.64	0.41	0.33		1	0.62	0.51	0.41	0.26	0.21	
		2	1.11	0.94	0.79	0.56	0.49		2	0.72	0.61	0.51	0.36	0.31	
		3	1.26	1.10	0.95	0.72	0.64		3	0.82	0.71	0.61	0.46	0.41	
		4	1.42	1.25	1.10	0.87	0.79		4	0.92	0.81	0.71	0.56	0.51	
		5	1.57	1.40	1.26	1.03	0.95		5	1.02	0.91	0.81	0.66	0.61	
6	1.73	1.56	1.41	1.18	1.10	6	1.12	1.01	0.91	0.76	0.71				

Plate Thickness (mm)	In Case of Coated Electrodes						Plate Thickness (mm)	In Case of CO <sub>2</sub> Flux Cored Wire						
	(θ°)	c(mm) b(mm)	0	1	2	3		4	(θ°)	c(mm) b(mm)	0	1	2	3
19	45	0	2.56	2.30	2.05	1.82	1.60	45	0	1.66	1.49	1.33	1.17	1.03
		1	2.89	2.62	2.38	2.14	1.92		1	1.87	1.70	1.54	1.38	1.24
		2	3.21	2.95	2.70	2.47	2.25		2	2.08	1.91	1.75	1.60	1.45
		3	3.54	3.27	3.03	2.80	2.57		3	2.29	2.12	1.96	1.81	1.66
		4	3.86	3.60	3.35	3.12	2.90		4	2.50	2.33	2.17	2.02	1.87
		5	4.19	3.93	3.68	3.44	3.22		5	2.71	2.54	2.38	2.23	2.08
	60	0	3.57	3.20	2.86	2.53	2.22	60	0	2.31	2.07	1.83	1.60	1.45
		1	3.89	3.53	3.18	2.86	2.55		1	2.52	2.38	2.23	2.08	
		2	4.22	3.85	3.51	3.18	2.87		2	2.73	2.49	2.25	2.02	
		3	4.54	4.18	3.83	3.51	3.20		3	2.94	2.70	2.46	2.23	
		4	4.87	4.50	4.16	3.83	3.53		4	3.15	2.91	2.67	2.44	
		5	5.20	4.83	4.48	4.16	3.85		5	3.36	3.12	2.88	2.65	
22	45	0	3.43	3.13	2.84	2.56	2.30	45	0	2.22	2.02	1.83	1.66	1.49
		1	3.81	3.50	3.21	2.94	2.67		1	2.46	2.27	2.08	1.90	
		2	4.19	3.88	3.59	3.31	3.05		2	2.71	2.51	2.32	2.14	
		3	4.56	4.26	3.97	3.69	3.43		3	2.95	2.75	2.57	2.39	
		4	4.94	4.63	4.34	4.07	3.81		4	3.20	3.00	2.81	2.63	
		5	5.32	5.01	4.72	4.44	4.18		5	3.44	3.24	3.05	2.84	
	60	0	4.78	4.36	3.95	3.57	3.20	60	0	3.09	2.82	2.56	2.31	2.07
		1	5.16	4.74	4.33	3.94	3.58		1	3.34	3.06	2.80	2.56	
		2	5.54	5.11	4.71	4.32	3.96		2	3.58	3.31	3.04	2.80	
		3	5.91	5.49	5.08	4.70	4.33		3	3.83	3.55	3.29	3.04	
		4	6.29	5.87	5.46	5.08	4.71		4	4.07	3.79	3.53	3.28	
		5	6.67	6.24	5.84	5.45	5.09		5	4.31	4.04	3.78	3.53	
6	7.05	6.62	6.21	5.83	5.46	6	4.56	4.28	4.02	3.77				

# The essentials of welding work

Mild steel electrode

1 The essentials of welding work with mild steel electrode									
Section	Standard	KS	E4301	E4303	E4311	E4313	E4316	E4324	E4327
	AWS				E6011	E6013	E7016	E7024	E6027
Weldability	Arc state		Spray type	A little stable	Rough spray type	Stable	Short maintain	Spray type	Spray type
	Weld penetration		Deep	Normal	Deep	Normal	A little deep	Normal	A little deep
	Slag state		A lot, totally covered	Totally covered	A little, partially covered	Totally covered	A lot, easily desquamate	Naturally desquamate	A lot, totally covered
	Bead appearance		Beautiful	Beautiful	Normal	Beautiful	Normal	Beautiful	Beautiful
	Fillet state		A little concave	A little concave	Flat	A little convex	A little concave	A little concave	A little concave
	Internal organization		Superb	Good	Good	Normal	Superb	Normal	Good
	Spatter		A lot	Normal	A lot	A little	Normal	A little	Normal
	the main purpose of use		Use in mild steel and generally use in every welding including construction, shipbuilding, etc	Suitable for every position including flat position, especially appropriate to filler welding which has short vertical leg	Suitable for every position, especially appropriate to vertical and overhead position which needs x-ray examination. Moreover it could be use for pipe, galvanized steel sheet and low alloy steel	Appropriate to thin plate welding with every position	Having good mechanical property among the mild steel electrodes. Not only appropriate to alloy steel, hard carbon steel and high sulfur but also to malleable cast iron, spring steel, plating welding and enameling. Please take notice of its drying	High efficiency, contains a lot of iron among the coating material. Easily arcing and few or no short circuit during the welding. E4327 has good deposited metallic nature. In the case of flat fillet, nonexpert could also manage to weld uniformly and completely	

## 2 The comparison of crack resistance

The crack resistance of deposited metal is the core element when choosing a welding electrode. the following is the comparison picture of coating material's basicity

The comparison of crack resistance

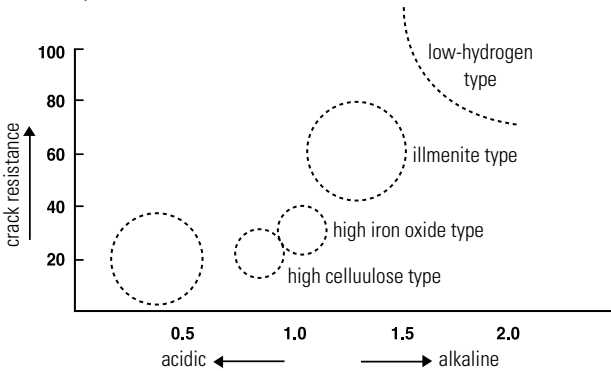

According to the picture, low-hydrogen type has the highest crack resistance and it is followed by illmenite, high iron oxide, high cellulose, high titanium oxide type. it means that work efficiency is improving if the coating material is more acidic type however on the contrary the crack resistance is declining.

Crack sensitivity =  $230C+190S+75P+45Nb-12.3Si-5.4Mn-1$

≤ 10: high crack resistance

20: cracking point

≥ 30: low crack resistance

# The essentials of welding work

High tensile and weatherproof steel electrodes

## 1 Drying of welding electrode

As the strength of welding electrode is high, the crack occurs more easily due to hydrogen and moisture absorption and also pit and blow hole occur frequently as well. To prevent the absorption, it is necessary to dry a welding electrode at constant temperature and moreover it needs to be stored at the degree of 100~150°C storage after drying.

Furthermore, after 2~4hours removing from the storage, it needs to be re-dried for proper uses.

## 2 Pre-heat and inter-pass temperature

Pre-heat maintains cooling rate of weld zone so that it could prevent hardening in HAZ and weld metal. Also, it could improve the ductility and foster the emission of Diffusion Hydrogen on the weld zone. Consequently, it proof against the weld crack.

The following table is the general temperature of preheat which is used for shielded metal arc welding. However, when the inter-pass temperature is over 200°C, its strength and impact value could decline. so it is advised to keep the proper temperature between the Pass. Like the preceding, it is advised to keep the proper temperature when doing tack welding, repair welding and gouging.

The example of preheat temperature (°C)

Steel Grade \ Plate Thickness (mm)	6~12	13~25	26~38	39~50
HT-50	needlessness	needlessness	under 70	40~100
HT-55	needlessness	under 70	40~100	70~120
HT-60	under 70	40~100	70~120	100~150
HT-70	40~100	70~120	100~150	120~180
HT-80	40~120	100~150	120~180	150~200
HT-100	40~150	120~180	150~200	150~200

**Attention:** When the temperature is under 10°C, preheat is needed, inter-pass temperature is under 200°C



### 3 Heat input

The following equation is the calculation of heat input.

$$\text{Heat input(J/cm)} = \frac{\text{welding current(A)} \times \text{arc voltage(V)} \times 60}{\text{welding speed(cm/min)}}$$

The welding heat input influences the cooling speed and Pass sequence. The bigger heat input makes not only the cooling speed slower but also makes the bigger bead grain so that the bead itself becomes thicker. The strength of weld metal would fall, yield strength and the impact value of weld metal would decline. Therefore, you have to be careful of too much heat input.

On the contrast, the smaller heat input makes the cooling speed faster. it causes the hardening of weld metal and parent metal. In result, the crack would appear on the weld zone.

In conclusion, in order to prevent the crack and doing a better welding, it is necessary to select the proper limit of heat input.

The example of welding heat input (KJ/cm)

Steel Grade \ Plate Thickness (mm)	6~12	13~25	26~38	39~50
HT-50, HT-55	under 30	10~50	10~50	15~60
HT-60	under 30	10~45	10~45	15~55
HT-70, HT-80	under25	10~40	10~40	15~45
HT-100	under 25	10~35	10~35	15~40

**Attention:** If the plate thickness is thinner, the upper limit has to be smaller than the indicated

### 4 General precautions

- 1) Keep the groove clean and choose the shape that less welding strain occurs
- 2) Over 50mm tack welding is needed and remove the tack weld when you do the regular welding
- 3) In order to prevent the blowhole, back step process is needed when starting arc.
- 4) Choose the welding method and welding process which can reduce residual stress and distortion.
- 5) Try to avoid the arc strike at the base metal. In unavoidable case. the repair welding must be needed to avoid crack.
- 6) You have to be careful especially during the humid weather in the summer that the weld crack easily occurs due to the increase of the hydrogen amount in the deposited metal.
- 7) When doing annealing for stress relief, the heating temperature has to be lower than the annealing temperature of the base metal.

# The essentials of welding work

High tensile and weatherproof steel electrodes

## 5 The pre-heat temperature and carbon equivalent

Steel Type	Carbon Equivalent (%)	Pre-Heat Temperature	Note
Carbon low alloy steel	≤0.3	≤100	Pre-Heat Temperature (°C)
	≤0.4	≥100	
	≤0.5	≥150	
	≤0.6	≥200	
	≤0.7	≥250	
	≤0.8	≥300	
	≥0.8	≥350	
High Mn steel		-	
Austenitic steel		-	
Stainless steel		-	
High alloy steel		≥400	

$$\text{Carbon equivalent (Ceq, \%)} = C + \frac{Mn}{6} + \frac{Si}{24} + \frac{Ni}{40} + \frac{Cr}{5} + \frac{Mo}{4} + \frac{V}{14}$$

## 6 The relationship between preheat temperature and weld crack index of steel

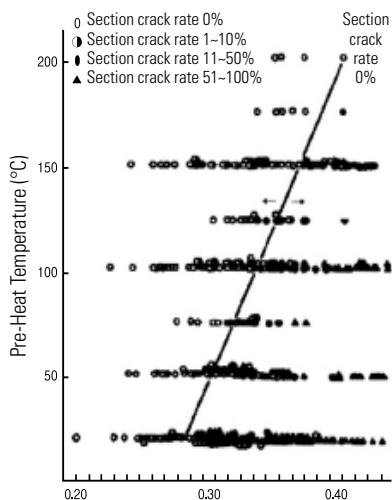

Chemical Component of Steel	C : 0.007 ~ 0.22
	Si : 0 ~ 0.60
	Mn : 0.40 ~ 1.40
	Cu : 0 ~ 0.50
	Ni : 0 ~ 1.20
	Cr : 0 ~ 1.20
	Mo : 0 ~ 0.70
	V : 0 ~ 0.12
	Ti : 0 ~ 0.05
	Nb : 0 ~ 0.04
B : 0 ~ 0.005	
Diffusion hydrogen amount H : 1.0 ~ 5.0cc/100g	
Plate thickness t : 19 ~ 50mm	
Intensity of restraint K : 500 ~ 3300Kg/mm-mm	
Heat input : 17 ~ 33KJ/cm	

Weld crack rate(Pc):

$$P_c = C + \frac{Si}{30} + \frac{Mn}{20} + \frac{Cu}{20} + \frac{Ni}{60} + \frac{Cr}{20} + \frac{Mo}{15} + \frac{V}{10} + 5B + \frac{t}{600} + \frac{H}{60} + (\%)$$

The relationship between the Pc and the preheat temperature(t=16~50mm)

Weld crack sensitivity(Pcm):

$$P_{cm}(\%) = C + \frac{Si}{30} + \frac{Mn}{20} + \frac{Cu}{20} + \frac{Ni}{60} + \frac{Cr}{20} + \frac{Mo}{15} + \frac{V}{10} + 5B$$

Crack sensitivity quotient(Pw):

$$P_w = P_{cm} + \frac{H}{60} + \frac{t}{600} = P_{cm} + \frac{H}{60} + \frac{K}{40,000}$$

H : Diffusion hydrogen amount      ml/100g

t : Plate thickness                      mm

K : Intensity of restraint                Kg/mm·mm

# The essentials of welding work

Low alloy heat resisting steel and low temp. steel electrode

## 1 The welding work of low temp. steel electrode

It needs proper preheat in order to get good impact values.

Plate Thickness (mm)	Preheat (KJ/cm)
6~12	under 25
13 ~ 25	10 ~3 5
26 ~ 50	15 ~ 30

**Attention:** The thinner plate thickness needs smaller preheat range. Drying, preheat, inter-pass temperature and general precautions of other electrode follow the rules of high tensile electrode.

## 2 The welding work with low alloy heat resisting steel electrode

The welding work of heat resisting steel electrode is essentially similar to high tensile steel electrode. However, it needs higher preheat and also post weld heat treatment after the welding work because of the hardening due to high content of Cr and Mo.

### 1) Preheating

The following is the welding preheat temperature in general.

You have to maintain a proper preheat temperature not only during the welding work but also until the beginning of the post weld heat treatment(PWHT). if the cooling is needed before the PWHT, you need to remove the hydrogen in advance.

Steel Type	Perheat Temperature (°C)
Mn-Mo-(Ni) 0.5% Mo 0.5% Cr-0.5% Mo	100 ~ 200
1% Cr-0.3% Mo 1% Cr-0.5% Mo 1.2% Cr-0.5% Mo	150 ~ 300
2.25% Cr-1% Mo 3% Cr-1% Mo 5% Cr-0.5% Mo	200 ~ 350

**Attention:** You must obey the following terms when doing a hydrogen elimination

Heating Temperature (°C)	Heating Hour (hr)
250	1 ~ 24
300	1 ~ 20
350	1 ~ 16

## 2) PWHT

A heat resisting steel has high self-hardening property, so the change of heat-affected zone is not sufficient enough by preheating and moreover because of its poor ductility and unstable matrix, PWHT is needed to get rid of residual stress so that it could avoid the welding crack. The following table indicates general terms of PWHT.

You need to be careful when heating long hour with extremely thick materials because there is a possibility of decreasing solidity due to the growing of ferrite particle. Maintaining temperature of middle welding PHWT has to be 30~60° lower than the final welding PHWT. Furthermore, the steel type which the annealing crack is easily occurs, you have to do grinding work before the PHWT.

### Terms of PWHT

Steel Type	The Plate Thickness which could skip The Heat Treatment (mm)	Maintaining Temperature (°C)	Maintaining Temperature (hr)	Heating, Cooling Speed (°C X hr)
Mn-Mo(Ni)	under 38	590 ~ 650	t/25 minimum 1hour	Over 400°C (1) Heating under 220 × 25/t must not over 220°C/hr (2) Cooling under 270 × 25/t must not over 220°C/hr
0.5% Mo 0.5% Cr - 0.5% Mo	under 16	600 ~ 650		
1% Cr - 0.3% Mo 1% Cr - 0.5% Mo 1.25% Cr - 0.3% Mo	under 13	620 ~ 720		
2.25% Cr - 1% Mo 3% Cr - 1% Mo	-	680 ~ 730		
5% Cr - 0.5% Mo	-	680 ~ 730		

t: plate thickness

# The essentials of welding work

## Surface hardening

Surface hardening welding is to deposit the special purpose alloy on the defected parent metal surface which is caused by abrasion, corrosion, thermal resistance and when you doing a the welding work you have to satisfy the following conditions.

- 1) Investigate the wear condition of parent metal
- 2) Choose the right electrode for the wear part
- 3) Choose the proper welding method.

### 1 The classification of abrasion shape

Wear means that the phenomenon of getting a crack or a part of the object falling off. Actual wear is very complicate. therefore, the following is the classification of the actual wear phenomenon.

#### 1) Grinding wear

- (1) The wear caused by the scratch and remaining fine soil on the surface due to the nonmetallic particle stress.
- (2) The wear that the steel surface is cut under the stress of nonmetallic particle and rich soil or hardened swelling
- (3) The wear that the steel surface is dug deeply due to impact and high tension.
- (4) The wear caused by the exercising fluidic particle.
- (5) The wear caused by the friction between steel and non-steel

#### 2) Adhesive wear

Adhesive wear is the wear due to two different steel's friction that the harden steel burst the soft one.

#### 3) Impact wear

The wear that a high impact makes a crack on the surface of the steel.

### 2 Crack prevention measures of surface hardening welding

Majority of anti-abrasion electrodes contain alloying element and the parent metal also contains a lot of high tensile alloy steel so it is easy to get a crack on it. Therefore, in order to prevent the crack, it is emphasized doing preheat and PWHT. For deciding its temperature,  $C_{eq}$  and  $H_v$  max. are used extensively.

$$\text{Carbon equivalent (Ceq, \%)} = C + \frac{1}{24}\text{Si} + \frac{1}{6}\text{Mn} + \frac{1}{15}\text{Ni} + \frac{1}{5}\text{Cr} + \frac{1}{4}\text{Mo} + \frac{1}{5}\text{V}$$

$$\text{The highest gradient (HV max.)} = 1200 \times \text{Ceq} - 200$$

HV max	Crack Prevention Measures
under 200	Unnecessary
200–250	Preheat and pwht needed (about 100°C) Preheat needed for thick plate, wide area welding and in winter season
250–325	Preheat for over 150°C, 650 × 1hr, stress relief
over 325	Preheat for over 250°C, right after welding 650 × 1hr, stress relief

### 3 Parent metal and carbon equivalent

Component Name	Steel Type	JIC symbol	Carbon Equivalent (%)
Truck roller	0.50–0.55C Carbon steel	S50C	0.65–0.75
Truck link	0.50–0.55C Carbon steel	S 45 C	0.50–0.70
		S Cr 4	0.65–0.75
		SCM 3	0.70–0.80
Tipper teeth	High mn steel	SCMnH	-
	Medium ni-cr-mo carbon steel	S Cr 4	0.65–0.75
Dredger cutter knife	Cast carbon steel	SC 49	0.35–0.40
	Low mn cast steel	SCA 2	0.50–0.55
	Medium carbon steel	S 45 C	0.55–0.65
	Medium ni-cr-mo carbon steel	SNCM 9	0.80–0.90
Dredger pump casing	Cast carbon steel	SC 46	0.35–0.40
	Low mn cast steel	SCA 51	0.65–0.75
	Medium carbon steel	-	0.65~
	Medium carbon ni-cr-mo steel	-	-
Jaw crusher	High mn steel	SCMnH	-
Gear	Medium carbon steel	S40C	0.40–0.65
	Medium carbon ni-cr-mo steel	SN CM1	0.70–0.80
	Cr-mo steel	SCM4	0.50–1.00
	Cast steel	-	-
Roller	Medium carbon steel	-	0.50–0.90
	High carbon steel	-	0.80–1.50
	High carbon cr-mo steel	-	1.40–2.50
	Cast iron	-	-
Punch for cold forging	Carbon tool steel	SK 3	1.0–1.2
	Dies steel	SK D 6	-
	High-speed steel	SKD	-
	Superhard alloy	-	-
Valve	Cast carbon steel	SC 46	0.35–0.40
	Stainless steel	-	-
	Copper alloy	SCS 14	-

**Attention:** The following equation is the calculation of the carbon equivalent





$$\text{Carbon equivalent (Ceq, \%)} = C + \frac{1}{24}Si + \frac{1}{6}Mn + \frac{1}{5}Cr + \frac{1}{4}Mo + \frac{1}{15}Ni$$

# The essentials of welding work





Surface hardening

## 4 Application of surface stiffen welding electrode

### 1) Engineering construction part





Component Name and Shape	Materials	Electrode				Note
		Under Laying		Over Laying		
		Name	Standard(JIC)	Name	Standard(JIC)	
Bulldozer Idler 	Medium carbon steel	S-7016-M	D4316	S-260A-B	DF2A-300-B	Preheat: ≥200°C
	Low alloy steel	S-7016-H	D5016	S-350B-B	DF2A-400-B	
Bulldozer Sprocket 	"	"	"	"	"	"
Bulldozer Shoe 	Medium carbon steel	S-7016-M S-7016-H	D4316 D5016	S-600A-B S-700B-B	DF2B-600-B DF2C-600-B	Preheat, PWHT: ≥200°C
	Manganese steel High manganese steel	-	-	S-700B-B S-13MN-B	DF3C-600-B DFMA-250-B	-
Bulldozer Link 	High carbon steel	S-7016-M	D4316	S-700B-B S-13MN-B	DF3C-600-B DFMA-250-B	Preheat, PWHT: ≥200°C
	Cast steel Medium carbon steel	S-7016-H	D5016	(final layer) S-700B-B	DF3C-600-B	



Component Name and Shape	Materials	Electrode				Note
		Under Laying		Over Laying		
		Name	Standard(JIC)	Name	Standard(JIC)	
Bulldozer Cutting Edge 	Carbon tool steel	S-7016-M S-7016-H	D4316 D5016	S-600B-B S-700B-B	DF2B-600-B DF3C-600-B	Preheat: ≥200°C
				S-13MN-B (When an object contains many rocks)	DFMA-250-B	
Bulldozer End-Bit 	Carbon tool steel	S-7016-M S-7016-H	D4316 D5016	S-600B-B S-700B-B	DF2B-600-B DF3C-600-B	Preheat: ≥200°C
				S-13MN-B (When an object contains many rocks)	DFMA-250-B	
Bulldozer Trunnion 	Silicon steel	S-7016-M S-7016-H S-8016-G S-9016-G	D4316 D5016 D5316 D5816	S-260A-B S-240A-R	DF2A-300-B DF2A-250-R	Preheat: ≥150°C
Bulldozer Shank Tip 	High carbon steel	S-7016-M S-7016-H	D4316 D5016	S-13MN-B (When an object contains many rocks)	DFMA-250-B	Preheat, PWHT: ≥200°C

# The essentials of welding work

## Surface hardening

Component Name and Shape	Materials	Electrode				Note
		Under Laying		Over Laying		
		Name	Standard(JIC)	Name	Standard(JIC)	
Bulldozer Roller 	Medium carbon steel	S-7016-M S-7016-H S-8016-G S-9016-G	D4316 D5016 D5316 D5816	S-260A-B S-600B-B S-700B-B	DF2A-300-B DF2B-600-B DF3C-600-B	Preheat: 70~150°C
Shovel Shoe 	High manganese steel	S-316-16N	D316-16	S-13MN-B  (final layer) S-700B-B	DFMA-250-B  DF3C-600-B	-
Shovel Roller 	Medium carbon steel Low alloy steel	S-7016-M S-7016-H S-8016-G S-9016-G	D4316 D5016 D5316 D5816	S-260A-B S-600B-B S-700B-B	DF2A-300-B DF2B-600-B DF3C-600-B	Preheat: 70~150°C
Shovel Sprocket 	Medium carbon steel Low alloy steel	"	"	"	"	Preheat: 100~150°C
Shovel Idler 	Medium carbon steel Low alloy steel	"	"	"	"	Preheat: 100~150°C

Component Name and Shape	Materials	Electrode				Note
		Under Laying		Over Laying		
		Name	Standard(JIC)	Name	Standard(JIC)	
Pinion Gear 	Medium carbon steel	"	"	"	"	Preheat: 70-150°C
Bucket 	Cast carbon steel	-	-	S-600B-B S-700B-B	DF2B-600-B DF3C-600-B	"
				S-13MN-B (When an object contains many rocks)	DFMA-250-B	
Bucket Tooth 	High manganese steel	S-316-16N S-13MN-B	D316 DFHE-200B	S-13MN-B S-350B-B	DFMA-250-B DF2A-400-B	"
				(fore-end) S-700B-B	DF3C-600-B	
Pin 	Silicon steel	-	-	S-600B-B S-700B-B	DF2B-600-B DF3C-600-B	Preheat: 70-150°C

SMAW

SAW

GMAW

GTAW

FCAW





Non-FERROUS

APPENDIX



# The essentials of welding work

## Surface hardening

### 2) Dredge part

Component Name and Shape	Materials	Electrode				Note
		Under Laying		Over Laying		
		Name	Standard(JIC)	Name	Standard(JIC)	
Pump Casing 	Cast carbon steel	S-7016-M	D4316	S-600B-B	DF2B-600-B	Preheat: 100~150°C
	Low manganese Cast steel	S-7016-H	D5016	S-700B-B	DF3C-600-B	
Pump Impeller 	Cast carbon steel	S-7016-M	D4316	S-600B-B	DF2B-600-B	Preheat: 100~150°C
	Low manganese Cast steel	S-7016-H	D5016	S-700B-B	DF3C-600-B	
Cutter Knife 	Cast carbon steel	S-7016-M	D4316	S-600B-B	DF2B-600-B	Preheat: 100~150°C
	Low manganese Cast steel	S-7016-H	D5016	S-700B-B	DF3C-600-B	
Bucket 	Mild steel	S-7016-M	D4316	S-600B-B	DF2B-600-B	Preheat: 70~150°C
	Cast carbon steel	S-7016-H	D5016	S-700B-B	DF3C-600-B	

### 3) Mining machinery part

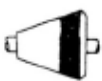
Component Name and Shape	Materials	Electrode				Note
		Under Laying		Over Laying		
		Name	Standard(JIC)	Name	Standard(JIC)	
Jaw Crusher Liner 	High manganese steel	S-7016-M	D4316	S-13MN-B	DFMA-250-B	-
		S-7016-H	D5016	(final layer)		
		S-8016-G	D5316	S-600B-B	DF2B-600-B	
		S-9016-G	D5816	S-700B-B	DF3C-600-B	
Cone Crusher Liner 	High manganese steel	S-7016-M	D4316	S-13MN-B	DFMA-250-B	-
		S-7016-H	D5016	(final layer)		
		S-8016-G	D5316	S-600B-B	DF2B-600-B	
		S-9016-G	D5816	S-700B-B	DF3C-600-B	
Roller Crusher Roll 	"	"	"	"	"	-
Cone Crusher Mantle 	"	"	"	"	"	-

# The essentials of welding work

## Surface hardening

Component Name and Shape	Materials	Electrode				Note
		Under Laying		Over Laying		
		Name	Standard(JIC)	Name	Standard(JIC)	
Crusher Hammer 	High manganese steel	S-316-16N	D316	S-13MN-B	DFMA-250-B	Water cooling welding
		S-13MN-B	DFHE-200B			
Screw Conveyer 	Mild steel Low alloy steel	-	-	S-600B-B	DF2B-600-B	Preheat: 100~150°C
				S-700B-B	DF3C-600-B	
Rock Drill Knife 	Medium carbon steel Low alloy medium carbon steel	-	-	S-700B-B	DF3C-600-B	Preheat: ≥250°C
Ladle Pin 	Cast carbon steel	-	-	S-600B-B	DF2B-600-B	Preheat: 70~150°C
				S-700B-B	DF3C-600-B	

Component Name and Shape	Materials	Electrode				Note
		Under Laying		Over Laying		
		Name	Standard(JIC)	Name	Standard(JIC)	
Crank Shaft 	Low alloy steel	-	-	S-260A-B	DF2A-300-B	Preheat: 100~150°C
Coupling 	Cast carbon steel	S-7016-M	D4316	S-260A-B	DF2A-300-B	Preheat: 70~150°C
		S-7016-H	D5016	S-240A-R	DF2A-250-R	
Roller 	"	"	"	"	"	"
Mn-Rail Crossing 	High manganese steel	S-308-16N	D308-16	S-13MN-B	DFMA-250-B	-
				(when connecting) S-308-16N S-240A-R	D308 DF2A-250-R	

# The essentials of welding work

Stainless steel

## 1 Notes on Usage

### 1) Re- dry welding

When welding rod coatings contains a large amount of moisture it can be the cause of a BlowHole. Also if the re-drying temperature is too high and because the thermal expansion coefficient of the core is large, the coating may crack during solidification.

### 2) welding current

When the welding current exceeds occurs a phenomenon in a honeycomb form at the late when welding, becoming the cause of each welding defects (undercuts, intergranular corrosion). Also in the case of DC welding it should lowered the current 10 to 15 percent more than the AC case.

### 3) Diferent cracks that occur during welding

The crack produced between Cr-Ni steel is a high-temperature crack of 900°C which appears on welding first and late time. This phenomenon occurs mainly because the low melting point compounds are gathered together in the austenite grain boundaries and the weld metal coagulates outside, and it occurs because it can't tolerate the stresses generated during contraction. Therefore to mitigate the cracking sensitivity it must add a small amount of ferrite in the Austenite system and limit below 150°C the interpass temperature

### 4) Thoroughly remove the remains in the weld area.

### 5) Arc distance and super arc welding

When welding it must keep a short arc distance to prevent oxidation damage and the intrusion of harmful elements should be suppressed . Also when super arc welding the imperfections in the coatings due to degradation and lack of protective gas shortage the deoxidized super arc blow hole occurs easily use the setback method or the alluvial gold method.

### 6) vertical upward welding

When welding the weld metal flows down the bead shape phenomenon can easily change to @ type, therefore the intermittent welding low current is recommendable.



## 2 Stainless steel weld metal composition and organization

The Organization is use to obtain the ferrite amount of the austenite stainless steel weld metal. In addition the organization besides stainless steel weld metal from steel to high-alloy steel weld metal with a wide range of organizations from across the chemical composition can be used to estimate. For example, carbon steel and stainless steel joints for Victim welded austenitic stainless steel or carbon steel materials when welding stainless steel welding materials, etc. If you want to foster the organization of the weld metal has been used to estimate.

Schaeffler Organization

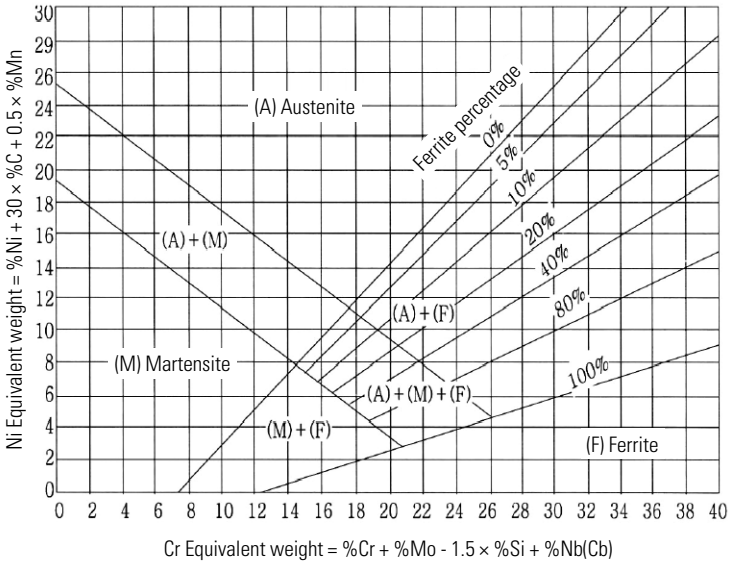

# The essentials of welding work

Stainless steel

Delong Organization

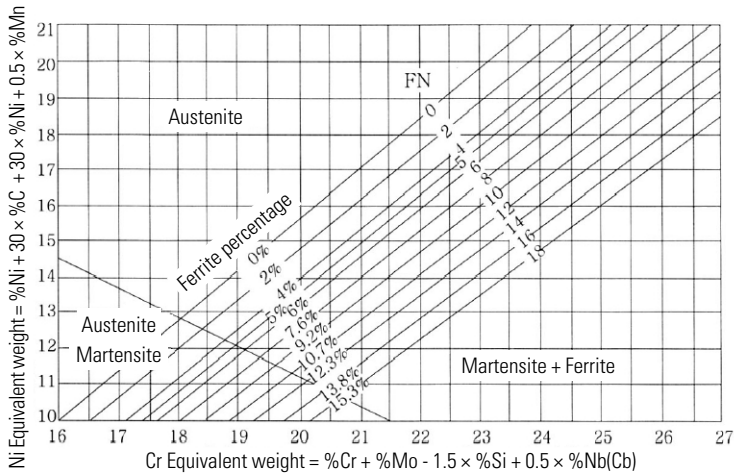

**Note:** In case of using this organization chart, it is recommendable to calculate the amount of nitrogen by analysis tests. Unless, please use the nitrogen content at 0.03% approximately.

WRC Organization

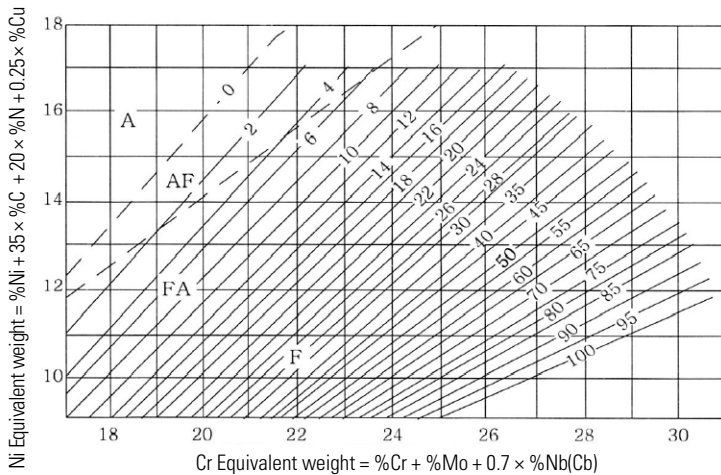

**Note:** In the table the A, AF, FA, F refers the solidification mode, A for austenite(Y) phase, AF for Y definition + ferrite process, FA for primary crystal+peritectic/process, F for single phase iron solification.

### 3 Intergranular corrosion

During 18% Cr-8% Ni welding the chromium carbide is deposited in the austenite boundaries (deposition temperature area 550~750°C) near the boundary of Cr concentration is diluted, Cr content necessary to ensure corrosion resistance is less than 11.7% and occurs first the corrosion. As a way to prevent this:

- 1) In case that the carbon contents less than retained the chromium carbide precipitation is hard, therefore it is recommendable the use of low carbon stainless welding rod(308L, 316L, ...)
- 2) Because the titanium, niobium has stronger affinity with carbon in 850~930°C than the chrome TiC, NbC are formed to prevent loss of Cr. Therefore it is recommendable the usage of stainless welding rods(309Cb, 347) with such stable elements(Ti, Nb)
- 3) In order to avoid 550~750°C temperature area(Chromim carbide precipitation) it is recommendable to quick cooling after low-current welding or normal welding.

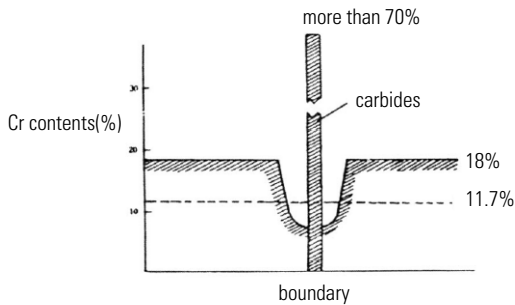

### 4 The role of ferrite in the weld metal

To prevent the cracking of solidification of the weld metal it is preferable to choose eld metal ferrite in the range of 5-8%

As the reason

- 1) The Ferrite elements and impurities harmful elements (P, S, Si, Nb, O)'s solid solubility is higher than autenite and due to the presence of ferrite during solidification of low melting point is less preventive, the solidification range is narrowed making it hard to crack.
- 2) The presence of ferrite lows thermal expansion the contraction stresses are reduced making difficult to cracks.

# The essentials of welding work

Stainless steel

## 5 Welding rod selection method

Base metal specification		Applicable welding rod specifications		HYUNDAI WELDING consumable
ANSI	JIS	ANSI	JIS	
301	SUS 301	E 308	D 308	S-308.16N
302	SUS 302	E 308	D 308	S-308.16N
304	SUS 304	E 308	D 308	S-308.16N
		E 308L	D 308L	S-308L.16N
304L	SUS304L	E 308L	D 308L	S-308L.16N
309		E 309	D 309	S-309.16N
		E 309L	D 309L	S-309L.16N
309S	SUS 309S	E 309	D 309	S-309.16N
		E 309L	D 309L	S-309L.16N
310		E 310	D 310	S-310.15
310S	SUS 310S	E 310	D 310	S-310.15
316	SUS 316	E 316	D 316	S-316.16N
		E 316L	D 316L	S-316L.16N
316L	SUS 316L	E 316L	D 316L	S-316.16N
321	SUS 321	E 347	D 347	S-347.16
347	SUS 347	E 347	D 347	S-347.16

## 6 Stainless heterogeneous welding material

Base metal	430	410	405	403	347	321	317L	317	316L	316	310S	309S	304L	304
304	309	309	309	309	347	347	317L	317L	316L	316	309	309	308L	308
304L	309L	309L	309L	309L	347	347	317L	317L	316L	316L	309L	309L	308L	
309S	309	309	309	309	309	309	309Mo	309Mo	309Mo	309Mo	309	309		
310S	NiCrFe-3	NiCrFe-3	NiCrFe-3	NiCrFe-3	NiCrFe-3	NiCrFe-3	309Mo	309Mo	309Mo	309Mo	310			
316	309Mo	309Mo	309Mo	309Mo	316L	316L	317L	317L	316L	316				
316L	309MoL	309MoL	309MoL	309MoL	316L	316L	317L	317L	316L					
317	309Mo	309Mo	309Mo	309Mo	317L	317L	317L	317L						
317L	309MoL	309MoL	309MoL	309MoL	317L	317L	317L							
321	309	309	309L	309L	347	347								
347	309	309	309L	309L	347									
403	430	410	430	410										
405	430	430	430											
410	430	410												
430	430													

# The essentials of welding work

Mains of cast iron

Arc welding of cast iron to 500~600°C of the base metal is heated to high temperatures without doing warm-up or local low-temperature hot- welding process for welding cold welding preheating is carried out.

## 1 Hot welding process

It is used with pure iron wire electrodes.

- 1) Base material in whole or preheated to 500~600°C local row.
- 2) It is good that the welding has weaving with continuous welding performance.
- 3) After welding is usually maintained at 600°C for one hour and the slowly cooled.

## 2 Cold welding process

It is good to use welding rod with alloy core of pure Ni-Fe, Ni-Cu, etc.

- 1) It must remove from the base part of the material all contaminants such as oil, rust, sand paint, etc.
- 2) If possible use one path welding rod and not weaving in low current when welding
- 3) Avoid the continuous welding making a short bead, symmetrical method, and with headstone method to stress relief.
- 4) Each bead innings carried the blood stress and residual stress in the weld with plan reduction.
- 5) Much more good results are obtained with a 100~200°C preheating.

SMAW

SAW

GMW

GTAW

FCAW

Non-FERROUS

APPENDIX

# The essentials of welding work

## Submerged arc

### 1 Submerged arc welding materials management

The correct welding material management is specially the X-Ray properties and impact toughness weld quality of the structure is important because it affects, so a crucial extra care is required.

- 1) It shall be stored on the pallet (temperature:  $20 \pm 10^{\circ}\text{C}$ , Relative humidity: maximum 70%)
- 2) In case of carrying overweight the packaging can't deal with the weight and break, therefore for safety it cannot carry more than 2 blocks.
- 3) It must have care because the packaging can suffer damage from improper handling during transportation. Also, It is absolutely prohibited transportation with rain or snow wether, but on the exceptions the material must be packaged with double water-proof packaging
- 4) The wire for rust prevention and with Welder Contact Tips the wire is made of copper plating to improve the electric current and to prevent the surface deterioration from harmful gases(sulfur dioxide, sea, wind, etc.) it must be kept isolated from such places also in case of storage the remaining wire be sure that the product is name and signed its dimensions. If the welding wire is rusted the electrical current with the contact tip and inhibit the feeding and with the arc unstable harming not only the outside but also becoming the reason of welding defects such as the Pit, the blow hole, etc.
- 5) In general, the Hyundai flux in order to get a good welding characteristics is fabricated with moisture content with as low as possible control(in the case of high temperature sintering mold, can be determined up to 0.1% at  $1000^{\circ}\text{C}$ ) and supplied with Tin can or Paper bag so it can prevent moisture. If there is a possibility that the flux enters in contact with rain or snow use the re-dried system to dry and after dried use it.

#### Methods for Flux re-drying management

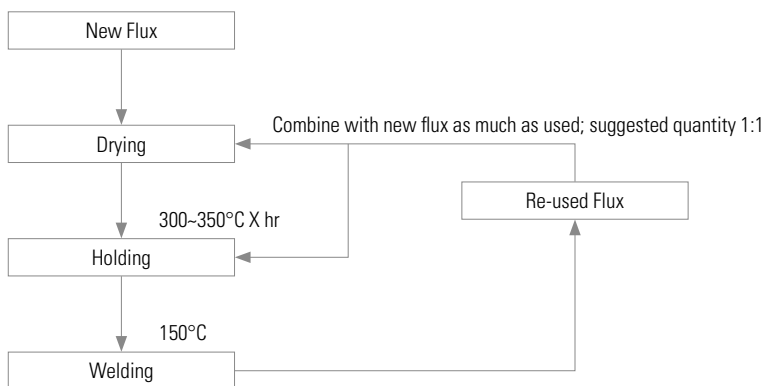

## Caution

- 1) It is appropriate redry the flux after took it out of its package spray it into the drawer with approx. 50mm of scatter space. The redrying time may vary depending on the flux weight, therefore review the redrying method before the performance.
- 2) Redried fluxes that are not used immediately it is recommendable to keep it at a maintaining temperature of  $150\pm 25^{\circ}\text{C}$ .
- 3) When Redry the flux separate it by the dry condition and maintenance condition, and by drying the moisture content of the flux can be managed to a minimum.

## 2 Wire diameter according to the appropriate current range

Proper current		under 400	300~350	350~800	500~1100	700~1600	above 1000
Wire diameter	mm	2.4	3.2	4.0	4.8	6.4	7.9
	inch	3/32	1/8	5/32	3/16	1/4	5/16

## Submerged arc welding wire chemical composition

Category	ID. Tag	Specifications	Chemical composition (%)			
			C	Si	Mn	Mo
L-8	Brown	A5.17 EL8	0.07	0.01	0.5	-
L-12	Blue	A5.17 EL12	0.09	0.02	0.5	-
M-12K	Red	A5.17 EM12K	0.10	0.20	1.0	-
H-14	Orange	A5.17 EH14	0.12	0.03	2.01	-
H-14L	Purple	A5.23 EG	0.05	0.02	1.98	-
A-3	Green	A5.23 EA3	0.08	0.01	1.82	0.47
A-G	Black	A5.23 EG	0.12	0.03	1.90	-

## 3 Carbon steel submerged arc welding precautions

- 1) Please store the flux in a dry place that is not damp one. On the other hand, before use redrying the flux to obtain a good welding quality. When repeat the scale, slag, contaminants, etc. The change of particle size distribution of the mixture and bead appearance may occur supplemented by a new flux to use.
- 2) Improvement in the rust, oil, contaminants, moisture, etc can be the cause of defectcs in the pit, blow hole, etc, therefore remove it.
- 3) If the improve angle, Root spacing are not accurate the burn through, incomplete penetration, and such as women and the overs and shorts may cause the degree of improvement than other welding methods should be accurate, improved angle :  $\pm 5^{\circ}$ , the root gap : up to 0.8mm, the root surface :  $\pm 1\text{mm}$ .

# The essentials of welding work

## Submerged arc

- 4) In the case of multi-layer welding, please note the following.
  - When the humidity is high or when the temperature is low, the greater the thickness welds please preheat before welding.
  - A relatively thin wire diameter should be used.
  - Improvement in the root pass welding conditions should be applied with low-current low speed.
  - Root pass weld root crack the binding of the cursor to happen because Yiwu improve the shape of the weld to resist arrest, please. (Section 4 (2) of the regulations.)
  - In order to improve the stripping slag welding voltage select in particular(approx.28 Volt) it is needed to pay attention to the medium and low-current welding conducted.
- 5) In particular, the welding of high strength steel that can be comparable to the base metal with excellent impact toughness of the weld metal of the wire to get the choice should be careful.
- 6) High strength steel material is hardened heat affected depending on the welding torch smell That cracks in metal, so please pay attention to the construction method.
- 7) The relatively low current re-arrested on two large multi-storey high-tensile steel to weld the crack to prevent the case Kilo class 50 and 60 of the 50~100°C for preheating and interpass temperature should be maintained. However, the type and thickness of steel, welding procedure, welding materials may vary depending on the characteristics of the appropriate preheat temperature calculated in advance, please Construction.

## 4 The main factors and measures of solidification cracking

### 1) Reception of the metal composition

\* Crack sensitive units (Unit of crack susceptibility: UCS factor)

$$= 230C + 190S + 75P + 45Nb - 12.3Si - 5.4Mn - 1$$

UCS ≤ 10: in the high crack resistance, UCS = 20: the start of the crack, UCS ≥ 30: in the crack resistance is low.

### 2) the form of weld metal solidification

\* The width of the weld bead / penetration depth (b / p) ratio of 1.0 to 1.25 times has to be selected for welding conditions.

b / p < 1.0: internal cracking risk, b / p > 1.25: risk of surface cracks

### 3) Pre-heating

(1) Preheat a large structure even in the case of the redemption of the weld is carried out in order to reduce shrinkage stress.



- (2) Excessive weld metal and HAZ hardenability, ductility to prevent lack of critical temperature on the cooling rate of the law is carried out in order to delay.
- (3) Under the fires bead (Underbead crack) to prevent cold cracking as the weld metal and the base metal near the hydrogen is released from the cooling rate for gatgi plenty of time to delay the warm-up to one conducted, in addition to prevent cracking of the weld Oil, water, removal of organic matter and the rate of hydrogen volcanoes occur quickly to prevent the blow hole is deungmok few.

**Caution**

- 1) Maintain a constant weld preheat temperature to prevent the occurrence of aggregation of the water and avoiding partial preheat and preheat improvement on the whole part.
- 2) Avoid welding preheat improve and improve surface if the thickness of the base metal on both sides is more than five times the width of the water in the preheat portion of weld improvement which clumping should eb prevented.
- 3) Excessive preheat may cause deformation(Distortion) of welded joints, as well as the cause of base metal impurity elements (C, P, S, etc.) rather than by increasing the dilution of clotting, which can cause cracking of the matrix, depending on the thickness, and carbon equivalent must be selected with proper temperature.

**5 Solution of welding defects**

Defect	Cause	Measures
Pock Mark	<ul style="list-style-type: none"> <li>1. Flux moisture</li> <li>2. Use of contaminated flux</li> <li>3. Foreign material presence in the welding (rust, paint, scale, etc.)</li> <li>4. Excessive flux spray height</li> <li>5. Undervalued welding voltage</li> <li>6. Excessive welding speed</li> </ul>	<ul style="list-style-type: none"> <li>1. Redrying the flux for 1 hour between 300~350°C</li> <li>2. Removement of foreign material and use of new flux</li> <li>3. Presence of foreign material in the welds (Brushing, Grinding, Fire, etc)</li> <li>4. Maintain the spray height to avoid arc direct exposure</li> <li>5. Increase of welding voltage</li> <li>6. Low the welding speed</li> </ul>
Porosity (Blow hole, Pin hole)	<ul style="list-style-type: none"> <li>1. Flux moisture</li> <li>2. Presence of foreign material and moisture in the welds</li> <li>3. Use of contaminated flux</li> <li>4. Low sprayed height of flux (Arc exposure)</li> <li>5. Grafting defects</li> <li>6. Excessive welding speed</li> </ul>	<ul style="list-style-type: none"> <li>1. Redrying the flux for 1 hour between 300~350°C</li> <li>2. Preheat and grinding clean of the welds</li> <li>3. Removement of foreign material and use of new flux</li> <li>4. Maintain the spray height to avoid arc direct exposure</li> <li>5. Grafting work and slag removal</li> <li>6. Low the welding speed</li> </ul>

# The essentials of welding work

## Submerged arc

<p>Crack (Transverse crack, Longitudinal crack)</p>	<ol style="list-style-type: none"> <li>1. Inappropriate selection of flux and wire</li> <li>2. When the C and S of steel are high</li> <li>3. When the bound of welds are severe</li> <li>4. When the ambient temperature of welding place is low</li> <li>5. Excessive penetration of the bead width</li> <li>6. Flux moisture</li> <li>7. When the welds improve grooves are inadequate</li> </ol>	<ol style="list-style-type: none"> <li>1. Selection of appropriate steel wire and flux</li> <li>2. Reduction of welding current and rate</li> <li>3. Adapted to withstand stresses of appropriate welding conditions</li> <li>4. Welding pre and post heat</li> <li>5. Application of low speed and low current</li> <li>6. Flux at 300~350°C for 1hour redrying</li> <li>7. Welds should greatly improve the angle of the groove</li> </ol>
<p>Slag inclusion</p>	<ol style="list-style-type: none"> <li>1. Leading slag by bad selection of welding direction</li> <li>2. Leading slag by over slow welding speed</li> <li>3. Inadequate aim location of the wire</li> <li>4. Bead shape of conductive layer defects</li> <li>5. Insufficient slag removal of conductive layer when multi layer welding</li> <li>6. Fire penetration</li> </ol>	<ol style="list-style-type: none"> <li>1. In a place without slope I must weld from low to high slope</li> <li>2. Increase welding speed</li> <li>3. In terms of improving the wire spacing to wire diameter</li> <li>4. Modify the weld bead shape by grinding</li> <li>5. Slag removal on conductive layer</li> <li>6. Deep penetration by increasing the welding current</li> </ol>
<p>Over lap</p>	<ol style="list-style-type: none"> <li>1. Excessive welding current</li> <li>2. Over low welding voltage</li> <li>3. Over low welding speed</li> <li>4. Inadequate wire diameter</li> <li>5. Inadequate aim location of wire</li> </ol>	<ol style="list-style-type: none"> <li>1. Reduce the welding current</li> <li>2. Increase the welding voltage</li> <li>3. Increase the welding speed</li> <li>4. Select appropriate wire diameter</li> <li>5. Control of wire aim positioning</li> </ol>
<p>Under cut</p>	<ol style="list-style-type: none"> <li>1. Excessive welding current</li> <li>2. Over low welding voltage</li> <li>3. Over low welding speed</li> <li>4. Inadequate wire diameter</li> <li>5. Inadequate aim location of wire(Fillet weld)</li> </ol>	<ol style="list-style-type: none"> <li>1. Reduce the welding current</li> <li>2. Increase the welding voltage</li> <li>3. Increase the welding speed</li> <li>4. Select appropriate wire diameter</li> <li>5. Control of wire aim positioning</li> </ol>
<p>Lack of penetration</p>	<ol style="list-style-type: none"> <li>1. Level of improvement of welded joints shape</li> <li>2. Over low of welding current</li> <li>3. Improper welding polarity</li> <li>4. Excessive welding voltage</li> <li>5. Excessive welding speed</li> <li>6. Inadequate aim location of wire</li> <li>7. Inadequate wire diameter</li> <li>8. Defects on selecting welding direction</li> </ol>	<ol style="list-style-type: none"> <li>1. Improve the level of geometric resolution (if is groove improvement's root surface, the interval between roots)</li> <li>2. Increase welding current</li> <li>3. Apply the welding polarity to DC+</li> <li>4. Low the welding voltage</li> <li>5. Low the welding speed</li> <li>6. Control of wire aim positioning</li> <li>7. Apply thin wire</li> <li>8. In a place without slope I must weld from low to high slope</li> </ol>

## 6 Tips for welding according to the improved forms

### 1) S-717, S-787TB, S-707TP, S-777MX, Superflux 787, S-777MXH apply (multilayer welding)

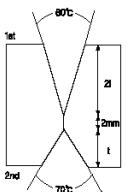
Improvement shape	Thickness (mm)	Wire diameter (mm)	Stacking sequence	Electrode	Polarity	Current (A)	Voltage (V)	Speed (cm/min)
	≥20	4.0	1st	Root	DC+	450~500	26~28	30~40
				Foster	DC+	500~600	28~30	30~50
			-	Back gouging				
			2nd	Root	DC+	450~500	26~28	30~40
				Foster	DC+	500~600	28~30	30~50
			4.0   4.0	1st	Root	L(DC+)	450~500	26~28
		Foster			L(DC+)	600~700	30~32	60~80
		-		Back gouging				
		2nd		Root	L(DC+)	450~500	26~28	30~40
				Foster	L(DC+)	600~700	30~32	60~80
		T(AC)		500~600	32~36	60~80		
		4.0   4.0   4.0	1st	Root	L(DC+)	450~500	26~28	30~40
				Foster	L(DC+)	600~700	30~32	70~90
			-	Back gouging				
			2nd	Root	L(DC+)	450~500	26~28	30~40
				Foster	L(DC+)	600~700	30~32	70~90
			T1(AC)	500~600	32~36	70~90		
		T2(AC)	400~500	34~36				

**Note:** Shield bead welding for melt prevention : GMAW, SM-70 1~2 layer welding

# The essentials of welding work

Submerged arc

## 2) S-707, S-717, S-727, S-787TB, S-707TP, S-777MX, S-777MXH, S-777MXT apply

(Both-sided single layer welding)

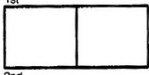
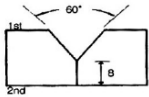
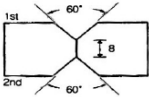
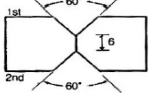
Thickness (min)	Wire Diameter (min)	Improvement	1st			2nd		
			Current (A)	Voltage (V)	Speed (cm/min)	Current (A)	Voltage (V)	Speed (cm/min)
6	4.0		500	34	60	600	36	60
8			550	34	55	650	36	55
10			650	34	50	750	36	50
12			700	34	50	800	36	50
14	4.8		700	34	35	800	36	55
16			750	34	35	825	36	55
18			800	34	30	850	36	50
20			850	34	30	875	36	45
22	4.8		800	34	30	900	35	40
25			825	34	35	825	36	40
28			850	34	30	950	36	35
30	4.8		875	34	30	950	36	30

## 3) S-727, S-777MX, S-777MXH, S-777MXT (Flat welding)

Improvement	Angle of Groove (L, mm)	Wire Diameter (mm)	Current (A)	Voltage (V)	Speed (cm/min)
	6	4.0	500	30	60~70
	7		600	32	60~70
	8		700	32	60~70
	9	4.8	650	34	50~60
	10		700	34	50~60
	12		750	34	40~50
	14		800	34	30~40

# The essentials of welding work

One side welding

## 1 SSB Process

### 1) Overview

One side automatic welding process, is made of double-sided adhesive tape a special structure that can be easily be manageable the backing material attached to the S-22, and the surface of the weld bead, forming and welding process is at the same time as housing and omitting.

S-22 is as shown in the figure below the cambium of fiberglass tape and one side bead layer height of special solid flux, refractory layer to prevent absorption of the asbestos and embedded in Heat Shrink Films the material position movement(turn-over) is limited simplifying the application to the automatic welding points.

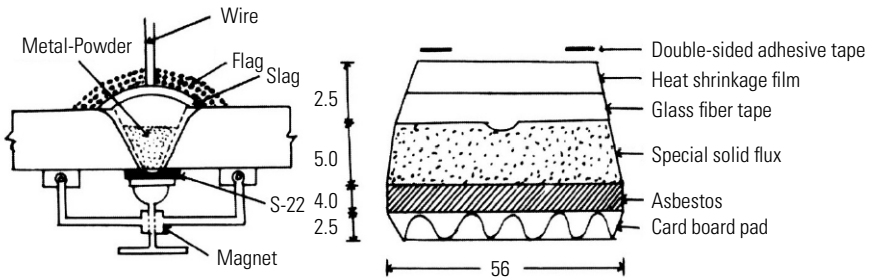

### 2) Characteristics

- (1) S-22 is not absorbed so it does not need to be redry.
- (2) S-22 is easy to handle as it is lighter.
- (3) Improved mounting side is that in the surface the double sided adhesive is possible, therefore the removal is more simple.
- (4) Have full flexibility and the improve side doest not fit well so it twists or the difference of thickness adaptability is large and the defects due to the backing material defections.
- (5) 300mm extent because the curvature of the surface of the material applied to the inflexibility is also available.

SMAW

SAW

GMMAW

GTAW

FCAW

Non-FERROUS

APPENDIX

# The essentials of welding work

## One side welding

### 3) Use

- (1) The automatic welding as material applicable, the both side automatic welding is a bit difficult, therefore applies the backing material S-22 to improve efficiency.
- (2) In particular, the upper deck for shipbuilding, bottom and side members inside and dock locations are suitable for welding.
- (3) Relatively heavy plate steel and plate welding structure applied to one side automatic welding to weld cost reduction and efficiency improvement.

### 4) Welding material

Force applied	Flux	Wire	Iron	Backing article
50kg/mm <sup>2</sup> class for mild steel and high strength steel	S-707	L-8	IRN	S-22(std.-type) S-22(M-type) S-22(S-type) CBM-600F
	S-705EF	H-14		

### 5) Example of welding conditions

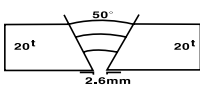
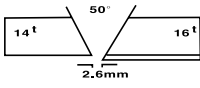
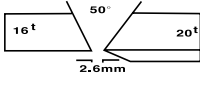
Thickness (mm)	Wire diameter (mm)	Iron height (mm)	Backing article	Improvement	Layers	Current (Amp)	Voltage (Volt)	Rate (Cpm)
20 x 20	4.8	13	Standard		1	860	34	38
					2	830	33	35
					3	720	34	35
14 x 16	4.8	14	M		1	960	34	23
16 x 20	4.8	14	S		1	960	34	23

# The essentials of welding work

Dioxide carbon gas

## 1 Welding conditions

Carbon dioxide gas arc welding wire range of welding conditions are shown in Figure 1. That's kind of appropriate welding conditions for welding of steel sheet thickness, etc. and for improving the shape changes. In addition, carbon dioxide gas arc welding process changes drastically the weld bead shape and performance on the conditions, so it is required to set the welding conditions carefully. The effects of the welding conditions are shown in Figure 2.

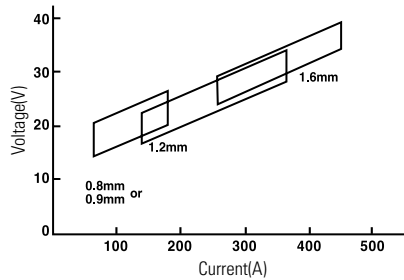

Draw 1. Appropriate welding conditions of the wire

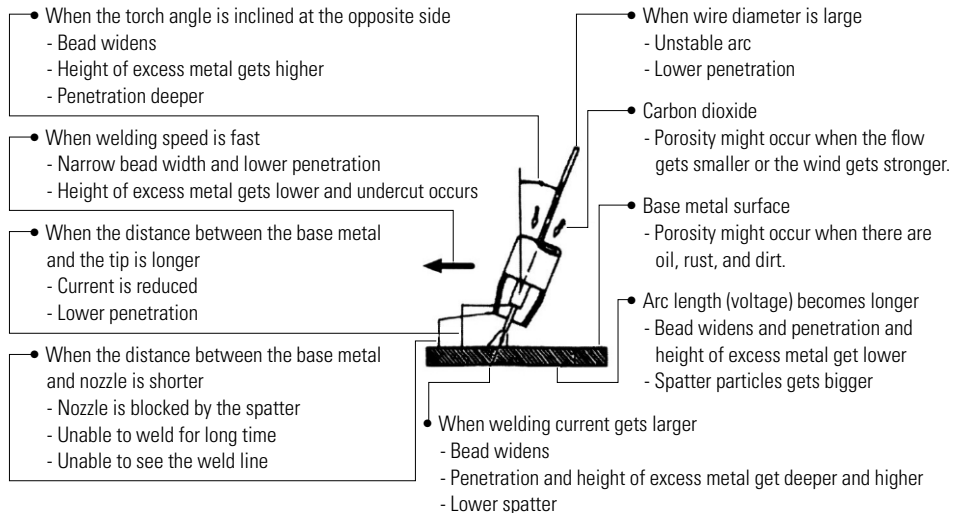

Draw 2. Welding conditions and its effects

### 1) Tip-base metal distance between

Tip-base metal distance between the bead shape, efficiency, etc., depending on the relationship, so using the current gap in Table 1 should be maintained

SMAW  
 SAW  
 GMAW  
 GTAW  
 FCAW  
 Non-FERROUS

APPENDIX

# The essentials of welding work

Dioxide carbon gas

Tip-base metal distance between the fair value of

Current to use	Distance between Tip-Base material (mm)	Note
< 250	6 ~ 15	As the current gets higher the distance between Tip-Base material gets larger
≥ 250	15 ~ 25	

## 2) The angle of the torch

Torch angle and manipulation method is shown in Figure 3.

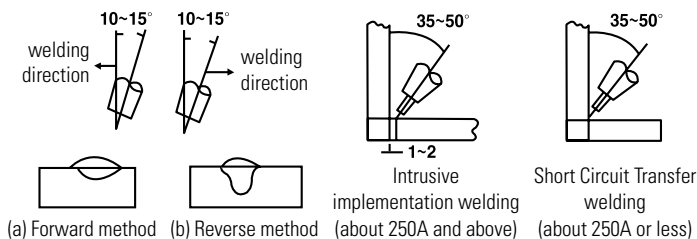

Draw 3. Angle of Torch

## 3) The slope of the base metal

It can obtain a good welding result in thin plate welding by slightly welding position. By the slope of the base metal bead shape the difference is shown in Figure 4.

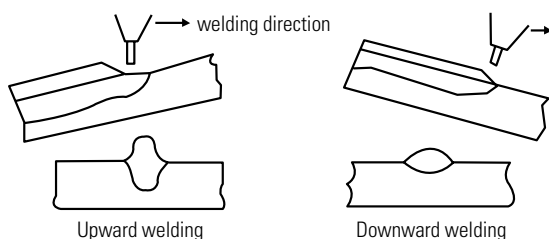

Draw 4. Bead phenomenon due to the inclination of the base metal

## 4) Carbonated gas flow

Carbon dioxide gas arc welding using carbon dioxide or using JIS 3 species carbonic acid gas welding. Also, the flow of the inherently 20 / min to the spill.



## 2 Weld preparation

### 1) Improving the processing

In the case of semi-automatic welding the results depends on the improve preparation, so the precision is high obtaining a clean improving process.

### 2) Grafting

Grafting dimensions of the bead, as shown in Figure 5 at the minimum possible. The end point, in order to prevent the defects the welding must be performed .with the same material and same thickness.

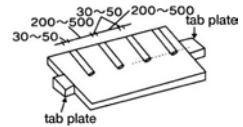

Draw 5. How to temp-welding

### 3) Improvement of the soil

The attached to the improve side it must keep, paint, moisture, excessive rust should be removed.

## 3 Wire storage

Wire wound on plastic spool should not re-dry. The surface of the wire is cover with copper and a special material, therefore the wire is hard to rust or absorb humidity, However if the wire stays a long time in a humid place the rust might appear, so please store the wire in a dry place if it is not in use for a long time.

## 4 Adjustment of welding

Carbon dioxide gas regulator, welding power source and wire feeding device, if there is a flaw in welding adversely affect the results, so please adjust the necessary.

## 5 General Precautions

### 1) Type of shielding gas

Protect the purity of the gas, in particular the water content in the weld, as well as cause a blow hole can cause hydrogen embrittlement of the following (1) to (3) above, please be aware of the selection.

- (1) CO<sub>2</sub> is JIS 3class (JIS K 1106) or CO<sub>2</sub> welding
- (2) Ar gas is for welding, Ar gas(JIS K 1105)
- (3) O<sub>2</sub> is JIS K 1101

# The essentials of welding work

Dioxide carbon gas

## 2) Shielding gas flow

If there is not enough gas flow it may occur a blow hole or a Pit and in case of using CO<sub>2</sub>, be aware of the following points.

- (1) If low-current (Wind velocity = 0): 15~20ℓ/min
- (2) For high current or wind 2m/sec about 25~30ℓ/min.

## 3) The arc voltage (arc length)

Penetrate when arc voltage change, bead shape and workability might be unstable, so please remain the arc voltage constant as possible.

## 4) Nozzle altitude

High or Low if the altitude of the nozzle is not constant the spatter might be attached and the supply of the CO<sub>2</sub> could be unstable producing the cause of a Blow hole or a Pit. Therefore remain constant the altitude of the nozzle.

## 5) Distance between tip- base material

Keep it 20mm.

## 6 Cause and measures for CO<sub>2</sub> welding defects

Type of defects	Cause	Measures
Blow hole, Pit	<ol style="list-style-type: none"><li>1. Incomplete gas protection</li><li>2. Excessive moisture content in the CO<sub>2</sub> gas</li><li>3. Steel rust, filth</li><li>4. Improper welding conditions</li></ol>	<ol style="list-style-type: none"><li>1. Gas flow adjustment, perfect protective gas effects</li><li>2. Use CO<sub>2</sub> gas of JIS 3 class of high purity</li><li>3. Rust, filth removal</li><li>4. Maintain proper conditions</li></ol>
Spatter	<ol style="list-style-type: none"><li>1. When the arc voltage is over low</li><li>2. When the welding current is high</li></ol>	<ol style="list-style-type: none"><li>1. Proper voltage at working</li><li>2. Proper current at working</li></ol>
Undercut	<ol style="list-style-type: none"><li>1. When the arc voltage is over high</li><li>2. When the welding speed is faster</li><li>3. When the welding current is over high</li></ol>	<ol style="list-style-type: none"><li>1. Maintain proper voltage</li><li>2. Maintain proper welding speed</li><li>3. Maintain proper current</li></ol>
Bead Exterior defects	<ol style="list-style-type: none"><li>1. When there is high voltage</li><li>2. When the manipulation speed is faster</li><li>3. When the base material is overheated</li><li>4. When the manipulation speed is instable</li></ol>	<ol style="list-style-type: none"><li>1. Maintain proper voltage</li><li>2. Maintain proper manipulation speed</li><li>3. Lower the interlayer temperature</li><li>4. Maintain constant manipulation speed</li></ol>

# The essentials of welding work

Flux cored wire

## 1 Storage

- 1) It must be stored in a dried and well ventilated place
  - humidity: under 60%
  - temperature under 30°C
- 2) The floor has to be flat and when storing on the Pallet it must be under 2 stages
- 3) Welding materials have to be store on the Pallet which at least 10cm away from the wall and floor
- 4) Avoid the easy contact of sea breeze, SO<sub>2</sub> gas, etc.

## 2 Transportation

Cover it with humid proof on snow, rain or high humidity days. also the packaging might suffer damage, so handle it with precaution.

## 3 Precautions when using

- 1) Before using maintain it in its original package
- 2) After use, the remaining should be packed in plastic bags in order to protect from any kind of humidity and storage in a dry place as mentioned in section (1).

SMW

SAW

GMW

GTW

FCW

Non-FERROUS

APPENDIX

# The essentials of welding work

Stainless wire

## 1) Welding power

Applying the characteristics of the DC voltage, use DC(+) when welding.

## 2) Shielding gas

The shielding gas usually uses the CO<sub>2</sub> or for better workability uses Ar + 20% CO<sub>2</sub> gas mixture

## 3) The distance between the tip and the base material (Stick-out)

0.9mm wire 15mm before and after and remain for 1.2~1.5mm wire 15~20mm

## 4) Windproof

When the wind speed around the arc exceed the 1m/sec it easily produce a blow hole, Arc 1m/sec exceed the wind speed near the blow hole is easy to occur, and the inhalation of atmospheric nitrogen, the amount of ferrite in the weld metal is easier to decrease the risk of hot cracking occurs please make the appropriate windproof.

## 5) Welding fume

Because the amount of welding fume is more than the solid wire, please make sure that the ventilation is enough

# The essentials of welding work

Inert gas arc

## 1 Overview

For inert gas welding protection there is the Ar, Ar + O<sub>2</sub>, Ar + CO<sub>2</sub> and is classified widely by TIG, MIG welding methods. The TIG welding method is the using of Ar in the arc produced between the active Tungsten and the base material. This method is each class of each strong class specially stainless sheet(3mm or less) welding using in the root pass of the pipe side welding and in marageing weldings, etc.

Because the flux current and the slag does not have any residual the work is more easy, and able to obtain a beautiful bead exterior, also because of the inert gas welding is performed it can obtain a clean weld metal.

MIG welding is the using of Ar, Ar + 2~5% O<sub>2</sub>, Ar + 5~70% CO<sub>2</sub> as a protective gas to the arc produced between the core and the base material depending on the application. This welding method is widely applicable and usually used on mild steel, high strength steel, low alloy steels, stainless steels welding.

Specially compared to other welding methods the current density is 6 times than mild steels, and because is 2 times higher than TIG welding the speed is extremely fast and efficient welding method.

Depending the core melted state is classified in short circuit transition, intrusive transition, and spray transition and in case of use 100% Ar protection gas the volume gets larger and the spray transition becomes difficult, therefore it may content the oxygen 2~5% so the arc can stabilize, and facilitate the spray transition.

## 2 Characteristics of MIG welding

The MIG welding is the using of the DC welding machine making it in a reverse polarity. The arc has a long a thin cone array in the center of the argon gas, and around it can see a vague beam in a cup form, and again surrounded by spilled argon gas.

The vague beam surrounding the cone in the central part is produced mainly by the argon gas light emitted and the ion gas urged between the base material surface and the electrode(+) makes the clean application.

SWAW

SAW

GMAW

GTAW

FCAW

Non-FERROUS

APPENDIX

# The essentials of welding work

## Inert gas arc

The melting rate of the covered arc is determined by the arc current independent from the arc voltage and the MIG welding is influenced by the arc voltage.

When the current gets at the same the arc voltage increases making the melting rate slow and when the electrode feed rate gets constant the arc length gets shorter returning to its original size, this effect its call the MIG arc attributes.

Difference to the flare groove welding, the MIG welding has arc voltage attributes, rising attributes, therefore the welding machine has to beb practically suitable with the proper constant voltage characteristics or rising characteristics.

### 3 TIG welding characteristics

In TIG welding(Tungsten inert gas arc welding) it is possible the usage of both direct current or alternating current. In the direct current the welding work might change depending the DC polarity, The most common gas to use in TIG welding in South Korea is the Ar gas.

#### 1) Direct current welding

In a positive welding the electron shocks with the base metal in a high speed making more heatable the base metal. In the reverse polarity welding has the opposite phenomenon the electrodes are heated with high temperature melting it at the final. Therefore in the reverse polarity it need to be use a more thicker electrode than the positive welding. For example, with a tungten electrode of 1.6mm diameter it might flow a welding current of 125A in a positive polarity, If the same current flows in the reverse polarity it is need a 6.4mm diameter of tungsten electrode. The opposite heating effect will affect the penetration depth and form. Therefore in the positive it is possible to obtain a weld with a small width and a deep penetration, but in the reverse because of the usage of a thick electrode usually uses a low current so it obtains a large width and a shallow weld.

#### 2) Clean application

Another characteristic of the reverse polarity welding is the clean effect(Plate cleaning action, surface cleaning action). Generally the accelerated gas ion with shocking on the base material surface produces the oxide substrates destruction as it knows, the cleaning application removes the metal oxide of the base material as the Sand Blastraw cleaning. For that, aluminium, magnesium, and others strong oxide metals or metals that has a high level melting the welding

is always possible. This cleaning application as an inert gas when using He gas the He ion is too lighter than when using Ar gas, therefore it is unable to get effectiveness. On the other side in the reverse the polarity is heated and melted mixing with the welding metal, also the arc get unstable and because the control of the welding gets hard so instead of aluminium or magnesium or the alloy welding they normally use in welding the following explained AC welding.

### 3) AC welding

The AC welding has the characteristics of the DC and reverse polarity welding, therefore can be used evenly. Simplifying, does not matter that the electrode diameter is smaller relatively, as using the Ar gas the oxide layer applies and the penetration is a bit wider and deep.

#### 4 Shielding gas type and Applicable base material and welding position

Arc Characteristics	Protection Gas	Apply Steel	Welding positions
Spray Arc	Argon	Aluminum, Aluminum alloy, Titanium, Titanium alloy, Nickel, Nickel alloy, Copper, Copper alloy	Lower 90° degree Horizontal fillet
	Argon + 2-5% Oxygen	Mild steel, High strength steel, Low alloy steel and stainless steel	Lower 90° degree Horizontal fillet
	Argon + 5-20% Carbon dioxide	Mild steel, High strength steel, and Low alloy steel	Lower 90° degree Horizontal fillet
Short Arc	Argon + 30-70% Carbon dioxide	Mild steel, Low alloy high strength steel and stainless steel	All positions
	Helium + Argon + Carbon dioxide (ex. 60%-35%-5%)	High strength steel, stainless steel, Nickel alloy steel	Lower 90° degree Horizontal fillet
	Helium + Argon + Carbon dioxide (ex. 60%-35%-5%)	High strength steel, stainless steel, Nickel alloy steel	Lower 90° degree Horizontal fillet
Pulse Arc	Argon + 2% Oxygen Argon + 5% Carbon dioxide	Mild steel, High strength steel, Stainless steel	All positions
	Argon	Nickel alloy(Inconel), Stainless steel	Lower 90° degree Horizontal fillet

# Storage and handling instructions

SMAW

## 1 The Storage and Treatment Standard of Welding Electrode

When releasing the thoroughly dried welding materials, the proper storage place is needed in order to prevent it from the moisture absorption, so it is necessary for worker's convenience to place the drying cabinet which is consistently under the temperature of 100~120°C.

The moisture absorption of welding materials highly depends on the climate condition. So everytime when releasing the dried materials, it is ideal way to select the limited working time and checking the temperature and humidity. However, practically it is almost impossible to do it due to the working condition of site. Therefore, in order to resolve this problem, it is essential to select the standard setting of worst condition.

Recently, in case of low hydrogen type electrode, we set up the moisture absorption limit under 0.6% and the standard considering every condition of workability as follows;

- 1) Put it in a drying road immediately after replacing the package.
- 2) Store it in a holding over right after the re-drying.
- 3) Using a portable drying machine prior to distribution in the actual site
- 4) Forecast the total quantity of demand for work(remaining electrodes should be retrieved and using again after re-drying)

## 2 Drying welding electrode and its moisture content

- 1) When packing the mild steel welding electrode, moisture content has to be managed as approximately 1.0%.
- 2) When packing the Low-hydrogen welding electrode after high temperature drying, moisture content has to be 0~0.5%.
- 3) The moisture absorption degree of Mild and Low Hydrogen welding electrode
  - a. Mild-steel welding electrode absorbs approximately 3% of moisture in 8 hours of complete neglectedness in the atmosphere(30°C relative humidity 80%)
  - b. Low-hydrogen welding electrode absorbs approximately 0.6% of moisture after completely dried in 5hours in the atmosphoere.(30°C relative humidity 80%)
- 4) Drying condition
  - a. When re-drying the welding electrode, I has to follow the proper drying (60mins) time and temperature and drying time should not be shorter than 30mins.
  - b. When the temperature exceed the maximum marginal temperature(depanding on type of electrode), it lower the workability due to the crack and alteration of coating materials.
  - c. Low-hydrogen electrode has to be dried in the temperature of 300°C for 1 hour and Mild-steel electrode doesn't need to be re-dry when storing in the warmed storage.



### 3 The re-drying and temperature maintenance of shielded metal arc welding electrode

#### Re-drying and temperature maintenance of welding electrode (AWS A5.1-91 Appendix Table A2)

AWS Classification	Re-drying	Temperature Maintenance
E6010,E6011	-	-
E6012, E6013, E6019, E6022, E6020, E6027, E7014, E7024, E7027	120~150°C 1 hour	12~24°C
E7015, E7016, E7018, E7028, E7048, E7018M	260~427°C 1 to 2 hours	30~140°C

#### Re-drying condition of welding electrode

Steel type	Covering material type	Product name	Limited moisture absorption ratio (%)	Dry Temp. (°C)	Dry Time (min.)
Mild Steel	Ilmenite	S-4301.I	2.5	70~100	30~60
	Lime titania	S-4303.V, S-4303.T	2.0		
	High cellulose	S-6010.D, S-6011.D	5.0		
	High oxidized titania	S-6013.LF, S-6013.V, S-7014.F, S-7024.F	3.0		
	Iron oxidized steel	S-6027.LF	2.0		
High Tensile Steel	Low hydrogen	S-7016.H, S-7016.LF, S-7016.M, S-7016.G, S-7016.O, S-7048.V	0.5	300~350	30~60
		S-7016.HR, S-8016.G, S-9016.G, S-10016.G, S-11016.G	0.5	350~400	60
	Iron powder low hydrogen	S-7018.G, S-7018.1, S-7028.F, S-8018.G, S-9018.M, S-11018.M, S-7018.W, S-8018.G	0.5	300~350	60
Weather Proof Steel	Iron powder low hydrogen	S-7018.W, S-8018.W	0.5	350~400	60
Low-temperature Service Steel	Low hydrogen	S-7016.LS, S-76LTH, S-8016.C1, S-8016.C2, S-8016.C3	0.5	350~400	60
	Iron powder low hydrogen	S-7018.1, S-7018.1H, S-78LTH, S-8018.C1, S-8018.C3			
Low Alloy, Heat Resist Steel	High cellulose	S-7010.A1	5.0	70~100	30~60
	Low hydrogen	S-7016.A1, S-8016.B1, S-8016.B2, S-9016.B3, S-8016.B5, S-8016.B6, S-9015.B9, S-9016.B9, S-9015.B92, S-9016.B92	0.5	350~400	60
		Iron powder low hydrogen			
Hard Facing Steel	Titania	S-240A.R, S-350B.B	2.0	70~100	30~60
	Low hydrogen	S-260A.B, S-350B.B, S-450B.B, S-500B.B, S-600B.B, S-700B.B, S-711, S-13MN.B	0.5	350~400	60
Stainless Steel	Lime titania	S-308(L).16N, S-309(L).16N, S-309Mo(L).16, S-316(L).16N, S-347.16, S-310.16, S-312.16, S-308L.17, S-316L.17, S-307.16, S-317.16, S-308LT.16, S-316LT.16, S-22019.16	1.0	300~350	30~60
Cast Iron	Graephite	S-NCI, S-NFC, S-FCF	1.5	70~100	30~60
Special Alloy	Low hydrogen	SR-134, SR-182, SR-133, SR-625	0.5	350~400	60

# Storage and handling instructions

SAW

## 1 Storage and handling

The fluxes of Hyundai welding for submerged arc welding (SAW) are generally manufactured from calcinated minerals which have been heat treated at high temperatures (400~1000°C) which gives excellent storage properties. The Hyundai Fluxes have a moisture content with a nominal level of max. 0.10% determined at 1000°C.

It is of great importance for the quality of the weld metal that moisture content is kept as low as possible.

Hyundai has set the following guidelines for handling to avoid these incidents:

- 1) Unopened cans/bags must be stored under warm and dry conditions. It is important that these conditions are maintained continuously.
- 2) Unopened cans/bags should not be exposed to direct moisture such as rain or snow.
- 3) Dry the flux at 300~350°C(572~662°F) for 60minutes before use.
- 4) Remaining flux from opened cans/bags or flux hopper should be stored at a temperature of 150±25°C.

If the fluxes have become wet, it could be possible to return the fluxes to their original state by redrying.

## 2 Redrying

When handled and stored according to the directions given earlier, redrying of the flux can restore its original condition with regard to moisture content should the flux pick up moisture due to unfavorable handling and storage.

Redrying is recommended to perform as follows: (Agglomerate Fluxes)

Recycle (Times)	Redrying (325±25°C)	Recommend to use (New flux : Redried flux)
1st	1 hour	-
2nd	2 hours	1 : 1
3rd	3 hours	1 : 1
4th	4 hours	1 : 1

Redried flux which is no immediately used should be stored at 150±25°C.

### 3 Recycling

Oil and moisture must be removed from the compressed air used in the recycling system. Foreign materials such as mill scale, dross etc. should be removed by a suitable method e. g. sieving and magnetic separation. Non consumed flux, collected from the weld, shall be cleaned from slag, mill scale, and dross etc.

\* Generally Recycle times is recommended less than 5 times.

### 4 Re-drying condition of welding flux

Steel type	Flux type	Product name	Limited moisture absorption ratio (%)	Dry Temp. (°C)	Dry time (min)
Flux Submerged	Agglomerated	S-707, S-707T, S-717, S-727, S-737, S-707TP, S-705EF, S-705HF, S-777MX, S-777MXH, S-777MXT, S-800MX, Superflux 800T, S-800WT, S-800SP, S-900SP, S-787TB, S-787TT, Superflux 55ULT, Superflux 55LP, S-460Y, S-800CM, S-400HF, Superflux 300S, Superflux 787, S-Ni2, Superflux 600, Superflux 800, S-800P, S-100	0.1	250-300	120

# Storage and handling instructions

FCW

## 1 FCW storage

To prevent contamination on the surface of the FCW wire the spool must be covered and in case of rough handling crack may occur in the surface.

In case of long period storage after opening the package pay attention that any crack may occur in the surface of the wire, in case of re-use try to keep any oil, grease substance from the wire surface in order to avoid absorption.

## 2 FCW Absorb prevention management

Generally to improve anti corrosive effects of the Flux Cored Wire the surface is treated by bluing or any other surface treatment process and to improve long term storage effects it is packaged by anti-rust volatile plastic.

## 3 FCW handling, packaging, preservation methods

As part of welding material management process it must comply with the following instructions to get the best welding consumable quality.

### 1) storage and handling

Appropriate conditions, ie, wrapped in a Spool or Coil standard package in a place with temperature not exceeding  $30\pm 10^{\circ}\text{C}$  and humidity less than 50~70% can prevent from any damage produced by humidity and contamination.

Specially when the diffusion of the deposited metal can be guaranteed it has to be wrapped in vacuum packed or any other appropriate method.

- (1) Welding material in its first packaging must be stored on a wood stand in a dry and well ventilated place with at least 10cm or more away from the wall and the floor.
- (2) Welding material should be stored classifying it in order of specification, product name and OD.
- (3) To avoid any external damage the welding material should be treated with care.

### 2) Re-drying

Generally because the wire surface and interior of the FCW absorbs the metal powder it may cause porosity in the weld metal, which can be prevented by re-drying the welding material.

The re-drying time is determined depending the package specifications. Re-drying at  $150^{\circ}\text{C}$  for at least 5 hours those products in coil, wire basket or mesonite spool,  $50^{\circ}\text{C}$  for at least 48 hours those in plastic spool. Always retire the plastic bag in re-drying process.

### 3) Cautions

- (1) The welder has to recollect the necessary amount of welding material for use to avoid maximum exposure.
- (2) When finished the welding work the FCW must be protected from moisture.
- (3) In case of using the FCW as welding material in welding work after rested 4 hours or more please comply one of the following methods to prevent moisture absorption.
  - Remove the FCW from the feeding device and keep it in a plastic bag.
  - Remove the FCW from the feeding device and store it in a dryer oven at  $30\pm 10^{\circ}\text{C}$ , 60% max. humidity.
  - It is not necessary remove the FCW from the feeding device 4 hours prior to performing again weld-work (In case of rain or high humidity 1 hour or less).

# Welding Standard Code

Classification	Code	Standard Name
Global Standard	ISO	International Organization for Standardization
National Standard	KS	Korean Industrial Standards
	JIS	Japanese Industrial Standards
	ANSI	American National Standards Institute
	BS	British Standards
	DIN	Deutsch Industrie Normen
	NF	Normes Francaises
	UNI	Ente Nazionale Italiano di Unificazione
	DOCT (GOST)	The National standards of Soviet Union
Group Standard	IIW	International Institute of Welding
	AWS	American Welding Society
	ASME	American Society of Mechanical Engineers
	ASTM	American Society for Testing and Materials
	AISI	American Iron and Steel Institute
	SAE	Society of Automotive Engineers
	MIL	Military Specification and Standards
	VDEh	Verein Deutscher Eisenhüttenleute
	JRS	Japanese Welding Engineering Society Standard
	WES	Japan Welding Engineering Society Standards
	CSA	Canadian Standards Association
	CWB	Canadian Welding Bureau (Welding-related Division of CSA)
	KR	Korean Register of Shipping
	ABS	American Bureau of Shipping
	LR	Lloyd's Register
	DNV	Det Norske Veritas
	NK	Nippon Kaiji Kyokai
	BV	Bureau Veritas
	GL	Germanischer Lloyd
	CCS	China Classification Society
	RINA	Registro Italiano Navale
	RS	Russian Maritime Register of Shipping
CRS	Croatian Register of Shipping	
TÜV	Technischer Überwachungs Verein	

# AWS Classification System

SMAW

## 1 AWS A 5.1

Specification for carbon steel electrodes for Shielded Metal Arc Welding

$\frac{E}{\textcircled{1}}$      $\frac{XX}{\textcircled{2}}$      $\frac{YY}{\textcircled{3}}$  -  $\frac{1}{\textcircled{4}}$      $\frac{HZ}{\textcircled{5}}$      $\frac{R}{\textcircled{6}}$

- ① Designates an electrode
- ② Designates the minimum tensile strength (ksi) - See Table 2
- ③ Designates the welding position, the type of covering, and the kind of welding current  
- See Table 1
- ④ Designates that the electrode meets the requirements for improved toughness
- ⑤ Designates that the electrode meets the requirements of the diffusible hydrogen test  
- See Table 4
- ⑥ Designates that the electrode meet the requirements of the absorbed moisture test - See Table 3

table 1 Electrode Classification

AWS Classification		Type of Covering	Welding Position	Type Current
A 5.1	A 5.1M			
E6010	E4310	High cellulose sodium	F, V, OH, H	DCEP
E6011	E4311	High cellulose potassium	F, V, OH, H	AC or DCEP
E6012	E4312	High titania sodium	F, V, OH, H	AC or DCEN
E6013	E4313	High titania potassium	F, V, OH, H	AC, DCEP, or DCEN
E6018	E4318	Low-hydrogen potassium, iron powder	F, V, OH, H	AC or DCEP
E6019	E4319	Iron oxide titania potassium	F, V, OH, H	AC, DCEP, or DCEN
E6020	E4320	High iron oxide	H-Fillet, F	AC or DCEN AC, DCEP, or DCEN
E6022	E4322	High iron oxide	F, H-Fillet	AC or DCEN
E6027	E4327	High iron oxide, iron powder	H-Fillet, F	AC or DCEN AC, DCEP, or DCEN
E7014	E4914	Iron powder, titania	F, V, OH, H	AC, DCEP, or DCEN
E7015	E4915	Low-hydrogen sodium	F, V, OH, H	DCEP
E7016	E4916	Low-hydrogen potassium	F, V, OH, H	AC or DCEP
E7018	E4918	Low-hydrogen potassium, iron powder	F, V, OH, H	AC or DCEP
E7018M	E4918M	Low-hydrogen iron powder	F, V, OH, H	DCEP
E7024	E4924	Iron powder, titania	H-Fillet, F	AC, DCEP, or DCEN
E7027	E4927	High iron oxide, iron powder	H-Fillet, F	AC or DCEN AC, DCEP, or DCEN
E7028	E4928	Low-hydrogen potassium, iron powder	H-Fillet	AC or DCEP
E7048	E4948	Low-hydrogen potassium, iron powder	F, OH, H, V-down	AC or DCEP

SMAW  
 SAW  
 GMAW  
 GTAW  
 FCAW  
 Non-FERROUS  
 APPENDIX

# AWS Classification System

SMAW

**table 2** Tension Test Requirements

AWS Classification		Tensile Strength		Yield strength at 0.2% Offset		Elongation Percentage In 4X Diameter Length
A 5.1	A 5.1M	A 5.1 (ksi)	A 5.1M (MPa)	A 5.1 (ksi)	A 5.1M (MPa)	
E6010	E4310	60	430	48	330	22
E6011	E4311	60	430	48	330	22
E6012	E4312	60	430	48	330	17
E6013	E4313	60	430	48	330	17
E6018	E4318	60	430	48	330	22
E6019	E4319	60	430	48	330	22
E6020	E4320	60	430	48	330	22
E6022	E4322	60	430	Not Specified		Not Specified
E6027	E4327	60	430	48	330	22
E7014	E4914	70	490	58	400	17
E7015	E4915	70	490	58	400	22
E7016	E4916	70	490	58	400	22
E7018	E4918	70	490	58	400	22
E7024	E4924	70	490	58	400	17 <sup>c</sup>
E7027	E4927	70	490	58	400	22
E7028	E4928	70	490	58	400	22
E7048	E4948	70	490	58	400	22
E7018M	E4918M	Note	Note	53-72	370-500	24

**table 3** Moisture Contents Limits For Electrode Coverings

AWS Classification		Electrode Designation		Limit of Moisture Content, % by Wt, Max.			
A 5.1	A 5.1M	A 5.1	A 5.1M	As-Received or conditioned	As-Exposed		
E6018	E4318	E6018	E4318	0.6	Not Specified		
E7015	E4915	E7015	E4915				
E7016	E4916	E7016	E4916				
		E7016-1	E4916-1				
E7018	E4918	E7018	E4918				
		E7018-1	E4918-1				
E7028	E4928	E7028	E4928				
E7048	E4948	E7048	E4948				
E6018	E4318	E6018R	E4318R			0.3	0.4
E7015	E4915	E7015R	E4915R				
E7016	E4916	E7016R	E4916R				
		E7016-1R	E4916-1R				
E7018	E4918	E7018R	E4918R				
		E7018-1R	E4918-1R				
E7028	E4928	E7028R	E4928R				
E7048	E4948	E7048R	E4948R				
E7018M	E4918M	E7018M	E4918M	0.1	0.4		



table 4 Diffusible Hydrogen Limits for Weld Metal

AWS Classification		Diffusible Hydrogen Designator	Diffusible Hydrogen Content, Average mL/100g Deposited Metal, Max.
A 5.1	A 5.1M		
E7018M	E4918M	None	4
E6018	E4318	H16 H8 H4	16 8 4
E7015	E4915		
E7016	E4916		
E7018	E4918		
E7028	E4928		
E7048	E4948		

## 2 AWS A 5.4

table 1 Chemical Composition Requirements for Undiluted Weld Metal

AWS Classification	Weight Percent <sup>b</sup>										
	C <sup>a</sup>	Cr	Ni	Mo	Cb(Nb) plus Ta	Mn	Si	P	S	N	Cu
E209-XX <sup>e</sup>	0.06	2.50-24.0	9.5-12.0	1.5-3.0	-	4.0-7.0	1.00	0.04	0.03	0.10-0.30	0.75
E219-XX	0.06	19.0-21.5	5.5-7.0	0.75	-	8.0-10.0	1.00	0.04	0.03	0.10-0.30	0.75
E240-XX	0.06	17.0-19.0	4.0-6.0	0.75	-	10.5-13.5	1.00	0.04	0.03	0.10-0.30	0.75
E307-XX	0.04-0.14	18.0-21.5	9.0-10.7	0.5-1.5	-	3.30-4.75	1.00	0.04	0.03	-	0.75
E308-XX	0.08	18.0-21.0	9.0-11.0	0.75	-	0.5-2.5	1.00	0.04	0.03	-	0.75
E308H-XX	0.04-0.08	18.0-21.0	9.0-11.0	0.75	-	0.5-2.5	1.00	0.04	0.03	-	0.75
E308L-XX	0.04	18.0-21.0	9.0-11.0	0.75	-	0.5-2.5	1.00	0.04	0.03	-	0.75
E308Mo-XX	0.08	18.0-21.0	9.0-12.0	2.0-3.0	-	0.5-2.5	1.00	0.04	0.03	-	0.75
E308MoL-XX	0.04	18.0-21.0	9.0-12.0	2.0-3.0	-	0.5-2.5	1.00	0.04	0.03	-	0.75
E309-XX	0.15	22.0-25.0	12.0-14.0	0.75	-	0.5-2.5	1.00	0.04	0.03	-	0.75
E309L-XX	0.04	22.0-25.0	12.0-14.0	0.75	-	0.5-2.5	1.00	0.04	0.03	-	0.75
E309Cb-XX	0.12	22.0-25.0	12.0-14.0	0.75	0.70-1.00	0.5-2.5	1.00	0.04	0.03	-	0.75
E309Mo-XX	0.12	22.0-25.0	12.0-14.0	2.0-3.0	-	0.5-2.5	1.00	0.04	0.03	-	0.75
E309LMo-XX	0.04	22.0-25.0	12.0-14.0	2.0-3.0	-	0.5-2.5	1.00	0.04	0.03	-	0.75
E310-XX	0.08-0.20	25.0-28.0	20.0-22.5	0.75	-	1.0-2.5	0.75	0.03	0.03	-	0.75
E310H-XX	0.35-0.45	25.0-28.0	20.0-22.5	0.75	-	1.0-2.5	0.75	0.03	0.03	-	0.75
E310Cb-XX	0.12	25.0-28.0	20.0-22.0	0.75	0.70-1.00	1.0-2.5	0.75	0.03	0.03	-	0.75
E310Mo-XX	0.12	25.0-28.0	20.0-22.0	2.0-3.0	-	1.0-2.5	0.75	0.03	0.03	-	0.75
E312-XX	0.15	28.0-32.0	8.0-10.5	0.75	-	0.5-2.5	1.00	0.04	0.03	-	0.75
E316-XX	0.08	17.0-20.0	11.0-14.0	2.0-3.0	-	0.5-2.5	1.00	0.04	0.03	-	0.75
E316H-XX	0.04-0.08	17.0-20.0	11.0-14.0	2.0-3.0	-	0.5-2.5	1.00	0.04	0.03	-	0.75
E316L-XX	0.04	17.0-20.0	11.0-14.0	2.0-3.0	-	0.5-2.5	1.00	0.04	0.03	-	0.75
E317-XX	0.08	18.0-21.0	12.0-14.0	3.0-4.0	-	0.5-2.5	1.00	0.04	0.03	-	0.75
E317L-XX	0.04	18.0-21.0	12.0-14.0	3.0-4.0	-	0.5-2.5	1.00	0.04	0.03	-	0.75

# AWS Classification System

SMAW

E318-XX	0.08	17.0-20.0	11.0-14.0	2.0-3.0	6 C, min to 1.00 max.	0.5-2.5	1.00	0.04	0.03	-	0.75
E320LR-XX	0.07	19.0-21.0	32.0-36.0	2.0-3.0	8 C, min to 1.00 max.	0.5-2.5	1.00	0.04	0.03	-	3.0-4.0
E320-XX	0.03	19.0-21.0	32.0-36.0	2.0-3.0	8 C, min to 0.40 max.	1.5-2.5	0.30	0.020	0.015	-	3.0-4.0
E330-XX	0.18-0.25	14.0-17.0	33.0-37.0	0.75	-	1.0-2.5	1.00	0.04	0.03	-	0.75
E330H-XX	0.35-0.45	14.0-17.0	33.0-37.0	0.75	-	1.0-2.5	1.00	0.04	0.03	-	0.75
E347-XX	0.08	18.0-21.0	9.0-11.0	0.75	6 C, min to 1.00 max	0.5-2.5	1.00	0.04	0.03	-	0.75
E349-XX	0.13	18.0-21.0	8.0-10.0	0.35- 0.65	0.75-1.20	0.5-2.5	1.00	0.04	0.03	-	0.75
E383-XX	0.03	26.5-29.0	30.0-33.0	3.2-4.2	-	0.5-2.5	0.90	0.02	0.02	-	0.6-1.5
E385-XX	0.03	19.5-21.5	24.0-26.0	4.2-5.2	-	1.0-2.5	0.90	0.03	0.02	-	1.2-2.0
E410-XX	0.12	11.0-13.5	0.7	0.75	-	1.0	0.90	0.04	0.03	-	0.75
E410NiMo-XX	0.06	11.0-12.5	4.0-5.0	0.40- 0.70	-	1.0	0.90	0.04	0.03	-	0.75
E430-XX	0.10	15.0-18.0	0.6	0.75	-	1.0	0.90	0.04	0.03	-	0.75
E502-XX	0.10	4.0-6.0	0.4	0.45- 0.65	-	1.0	0.90	0.04	0.03	-	0.75
E630-XX	0.05	16.00- 16.75	4.5-5.0	0.75	0.15-0.30	0.25-0.75	0.75	0.04	0.03	-	3.25- 4.00
E16-8 2-XX	0.10	14.5-16.5	7.5-9.5	1.0-2.0	-	0.5-2.5	0.60	0.03	0.03	-	0.75
E7Cr-XX	0.10	6.0-8.0	0.4	0.45- 0.65	-	1.0	0.90	0.04	0.03	-	0.75
E2209-XX	0.04	21.5-23.5	8.5-10.5	2.5-3.5	-	0.5-2.0	0.90	0.04	0.03	0.08-0.20	0.75
E2553-XX	0.06	24.0-27.0	6.5-8.5	2.9-3.9	-	0.5-1.5	1.0	0.04	0.03	0.10-0.25	1.5-2.5

## Notes:

- a. Analysis shall be made for the elements for which specific values are shown in the table. If however, the presence of other elements is indicated in the course of routine analysis, further analysis shall be made to determine that the total these other elements, except iron, is not present in excess of 0.50 percent.
- b. Single values are maximum percentages.
- c. Classification suffix-XX may be - 15, -16, -17, -25 or -26
- d. Vanadium shall be 0.10 to 0.30 percent
- e. Titanium shall be 0.15 percent max.
- f. Tungsten shall be from 1.25 to 1.75 percent.

**table 2** Mechanical Property Requirement of All-Weld Metal for Covered Electrodes

AWS Classification	Tensile strength. mi.		Elongation min. Percent	Heat Treatment
	ksi	MPa		
E209-XX	100	690	15	none
E219-XX	90	620	15	none
E240-XX	100	690	15	none
E307-XX	85	590	30	none
E308-XX	80	550	35	none
E308H-XX	80	550	35	none
E308L-XX	75	520	35	none
E308Mo-XX	80	550	35	none
E309-XX	80	550	35	none
E309L-XX	75	520	30	none
E309Cb-XX	80	550	30	none
E309Mo-XX	80	550	30	none
E309MoL-XX	75	520	30	none
E310-XX	80	550	30	none
E310H-XX	90	620	10	none
E310Cb-XX	80	550	25	none
E310Mo-XX	80	550	30	none
E312-XX	95	660	22	none
E316-XX	75	520	30	none
E316H-XX	75	520	30	none
E316L-XX	70	490	30	none
E317-XX	80	550	30	none
E317L-XX	75	520	30	none
E318-XX	80	550	25	none
E320-XX	80	550	30	none
E320LR-XX	75	520	30	none
E330-XX	75	520	25	none
E330H-XX	90	620	10	none
E347-XX	75	520	30	none
E349-XX	100	690	25	none
E383-XX	75	520	30	none
E385-XX	75	520	30	none
E410-XX	75	450	20	a
E410NiMo-XX	110	760	15	c
E430-XX	65	450	20	d
E502-XX	60	420	20	b
E505-XX	60	420	20	b
E630-XX	135	930	7	e
E16-8-2-XX	80	550	35	none
E7Cr-XX	60	420	20	b
E2209-XX	100	690	20	none
E2553-XX	110	760	15	none

# AWS Classification System

SMAW

## Notes:

- Heat to 1350 to 1400°F(730 to 760°C), hold for one hour, furnace cool at rate of 100°F(60°C)per hour to 600°F(315°C) and air cool to ambient.
- Heat to 1550 to 1600°F(840 to 870°C), hold for two hour, furnace cool at rate not exceeding 100°F(55°C)per hour to 1100°F(595°C) and air cool to ambient.
- Heat to 1100 to 1150°F(595 to 620°C), hold for one hour, and air cool to ambient.
- Heat to 1400 to 1450°F(760 to 790°C), hold for two hour, furnace cool at rate not exceeding 100°F(55°C)per hour to 1100°F(595°C) and air cool to ambient.
- Heat to 1875 to 1925°F(1025 to 1050°C), hold for one hour, and air cool to ambient, and than precipitation harden at 1135 to 1165°F(610 to 630°C), hold for four hours, and air cool to ambient.

## 3 AWS A 5.5

table 1 Composition Requirements of Covered electrodes for Low Alloy Steels

Electrode Classification	Chemical Composition, Percent								
	C	Mn	P	S	Si	Ni	Cr	Mo	V
<b>Carbon-Molybdenum Steel Electrodes</b>									
E7010-A1		0.60			0.40				
E7011-A1		0.60			0.40				
E7015-A1		0.90			0.60				
E7016-A1	0.12	0.90	0.03	0.03	0.60	...	...	0.40 to 0.65	...
E7018-A1		0.90			0.80				
E7020-A1		0.60			0.40				
E7027-A1		1.00			0.40				
<b>Chromium-Molybdenum Steel Electrodes</b>									
E8016-B1	0.05 to 0.12	0.90	0.03	0.03	0.60	...	0.40 to 0.65	0.40 to 0.65	...
E8018-B1					0.80				
E7016-B2L	0.05	0.90	0.03	0.03	0.60	...	1.00 to 1.50	0.40 to 0.65	...
E8016-B2	0.05 to 0.12	0.90	0.03	0.03	0.60	...	1.00 to 1.50	0.40 to 0.65	...
E8018-B2					1.00	...	2.00 to 2.50	0.90 to 1.20	...
E9015-B3	0.05 to 0.12	0.90	0.03	0.03	1.00	...	2.00 to 2.50	0.90 to 1.20	...
E9016-B3					0.60				
E9018-B3					0.80				
E8018-B3L	0.05	0.90			0.80	...	2.00 to 2.50	0.90 to 1.20	...
E8015-B3L	0.05	0.90	0.03	0.03	1.00	...	1.75 to 2.25	0.40 to 0.65	...
E8016-B5	0.07 to 0.15	0.04 to 0.70			0.30 to 0.60	...	0.40 to 0.60	1.00 to 1.25	0.05

Nickel Steel Electrodes									
E8016-C1 E8018-C1	0.12	1.25	0.03	0.03	0.60 0.80	2.00 to 2.75	...	...	...
E8016-C2 E8018-C2	0.12	1.25	0.03	0.03	0.60 0.80	3.00 to 3.75	...	...	...
E8016-C3 E8018-C3	0.12	0.04 to 1.25	0.03	0.03	0.80	0.80 to 1.10	0.15	0.35	0.05
Manganese-Molybdenum Steel Electrodes									
E8018-D1	0.12	1.00 to 1.75	0.03	0.03	0.80	...	...	0.25 to 0.45	...
E10015-D2 E10016-D2 E10018-D2	0.15	1.65 to 2.00	0.03	0.03	0.60 0.60 0.80	...	...	0.25 to 0.45	...
Other Low-Alloy Steel Electrodes									
EXX10-G EXX11-G EXX13-G EXX15-G EXX16-G EXX18-G E7020-G	...	1.00min	...	...	0.80min	0.50min.	0.30min.	0.20min.	0.10min.
E9018-M E10018-M E11018-M E12018-M	0.10 0.10 0.10 0.10	0.60 to 1.25 0.75 to 1.70 1.30 to 1.80 1.30 to 2.25	0.030 0.030 0.030 0.030	0.030 0.030 0.030 0.030	0.80 0.60 0.60 0.60	1.40 to 1.80 1.40 to 2.10 1.25 to 2.50 1.75 to 2.25	0.15 0.35 0.40 0.30 to 1.50	0.35 0.25 to 0.50 0.25 to 0.50 0.30 to 0.55	0.05 0.05 0.05 0.05

**Note:** Single values shown are Maximum percentage except where otherwise specified

# AWS Classification System

SMAW

**table 2** Mechanical Property Requirements of All Weld Metal for Covered Electrodes for Low Alloy Steels

AWS Classification	Tensile Strength min. psi	Yield Strength at 0.2 Percent offset, psi	Elongation 2 inch, min, Percent
E7010-X	70,000	57,000	22
E7011-X			22
E7015-X			25
E7016-X			22
E7018-X			22
E7020-X			22
E7027-X	80,000	67,000	22
E8010-X			19
E8011-X			19
E8013-X			16
E8015-X			19
E8016-X			19
E8018-X			19
E8016-C3	80,000	68,000 to 80,000	24
E8018-C3			
E9010-X	90,000	77,000	17
E9011-X			17
E9013-X			14
E9015-X			17
E9016-X			17
E9018-X			17
E9018-M	90,000	78,000 to 110,000	24
E10010-X	100,000	87,000	16
E10011-X			16
E10013-X			13
E10015-X			16
E10016-X			16
E10018-X			16
E10018-M	100,000	88,000 to 90,000	20
E11051-X	110,000	97,000	15
E11016-X			
E11018-X			
E11081-M	110,000	98,000 to 110,000	20
E12015-X	120,000	107,000	14
E12016-X			
E12018-X			
E12018-M	120,000	108,000 to 120,000	18
E12018-M1			

**table 3** Impact-Property Requirements of Covered Electrodes for Low Alloy Steels

AWS Classification	Minimum V-Notch Impact Requirement
E8018-NM E8016-C3 E8018-C3	20 ft·lb at -40°F <sup>b</sup> (27J at -40°C)
E8016-D3 E8018-D3 E8015-D1 E8018-D1 E10015-D2 E10016-D2 E10018-D2	20 ft·lb at -60°F <sup>b</sup> (27J at -51°C)
E7018-W1 E8018-W2	20 ft·lb at 0°F <sup>b</sup> (27J at -18°C)
E9018-M E10018-M E11018-M E12018-M	20 ft·lb at -60°F <sup>b</sup> (27J at -51°C)
E12018-M1	50 ft·lb at 0°F <sup>b</sup> (68J at -18°C)
E8016-C1 E8018-C1	20 ft·lb at -75°F <sup>b</sup> (27J at -59°C)
E7015-C1L E7016-C1L E7018-C1L E8016-C2 E8018-C2	20 ft·lb at -100°F <sup>b</sup> (27J at -73°C)
E7015-C2L E7016-C2L E7018-C2L	20 ft·lb at -150°F <sup>b</sup> (27J at -101°C)
All other classifications	Not required

- a. The extremely lowest value obtained together with the extremely highest value shall be disregarded for this test. Two of the three remaining values shall be greater than the specified 20 ft·lb energy level; one of the three may be lower but shall not be less than 15 ft·lb. The computed average value of the three remaining values shall be equal to, or greater than, the 20 ft·lb energy level
- b. As-welded impact properties.
- c. Stress-relieved properties.

# AWS Classification System

SAW

## 1 AWS A 5.17

Specification for carbon steel electrodes and fluxes for Submerged Arc Welding

F    S    X    X    X    –    ECXXX    –    HX  
 ①    ②    ③    ④    ⑤       ⑥       ⑦

- ① Indicates a submerged arc welding flux
- ② Indicates that the welding flux being classified is made solely from crushed slag or is a blend of Crushed slag with unused (virgin) flux. Omission of the “S” indicates that the flux being classified is virgin flux
- ③ Indicates the minimum tensile strength – See Table 2
- ④ Designates the condition of heat treatment in which the tests were conducted ; “A” for as Welded and “P” for postweld heat treated
- ⑤ Indicates a temperature in “F” (For impact test) – See Table 3
- ⑥ Indicates classification of the electrode – Refer to Table 1
- ⑦ Optional supplemental diffusible hydrogen designator – See Table 4

table 1 Chemical Composition Requirements for Solid Electrodes

Electrode Classification	UNS Number	wt. percent						
		C	Mn	Si	S	P	Cu <sup>(4)</sup>	Ti
<b>Low-Manganese Electrodes</b>								
EL8	K01008	0.10	0.25/0.60	0.07	0.030	0.030	0.35	-
EL8K	K01009	0.10	0.25/0.60	0.10/0.25	0.030	0.030	0.35	-
EL12	K01012	0.04/0.14	0.25/0.60	0.10	0.030	0.030	0.35	-
<b>Medium-Manganese Electrodes</b>								
EM11K	K01111	0.07/0.15	1.00/1.50	0.65/0.85	0.030	0.025	0.35	-
EM12	K01112	0.06/0.15	0.80/1.25	0.10	0.030	0.030	0.35	-
EM12K	K01113	0.05/0.15	0.80/1.25	0.10/0.35	0.030	0.030	0.35	-
EM13K	K01313	0.06/0.16	0.90/1.40	0.35/0.75	0.030	0.030	0.35	-
EM14K	K01314	0.06/0.19	0.90/1.40	0.35/0.75	0.025	0.025	0.35	0.03/0.17
EM15K	K01515	0.10/0.20	0.80/1.25	0.10/0.35	0.030	0.030	0.35	-
<b>High-Manganese Electrodes</b>								
EH10K	K01210	0.07/0.15	1.30/1.70	0.05/0.25	0.025	0.025	0.35	-
EH11K	K11140	0.07/0.15	1.40/1.85	0.80/1.15	0.030	0.030	0.35	-
EH12K	K01213	0.06/0.15	1.50/2.00	0.25/0.65	0.025	0.025	0.35	-
EH14	K11585	0.10/0.20	1.70/2.20	0.10	0.030	0.030	0.35	-
EG		Not-Specified						



table 2 A5.17 Tension Test Requirements

Flux-Electrode Classifications	Tensile Strength, psi	Yield Strength, psi	Elongations, %
F6XX-EXXX	60 000-80 000	48 000	22
F7XX-EXXX	70 000-95 000	58 000	22

table 3 A5.17 Impact Test Requirements

Digit	Maximum Test Temperature, °F	Minimum Test Average Energy Level
0	0	20 ft-lbf
2	-20	
4	-40	
5	-50	
6	-60	
8	-80	
Z	No impact requirements	

table 4 Diffusible Hydrogen Requirements

AWS Flux-Electrode Combination Classification	Optional Supplemental Diffusible Hydrogen Designation	Average Diffusible Hydrogen Maximum (mL/100g Deposited Metal)
All	H16	16.0
All	H8	8.0
All	H4	4.0
All	H2	2.0

## 2 AWS A 5.23

Specification for low alloy steel electrodes and fluxes for Submerged Arc Welding

F   X   X   X - E   C   XXX   N - XN  
 ①   ②   ③   ④   ⑤   ⑥   ⑦   ⑧   ⑨

- ① Indicates flux
- ② Indicates the minimum tensile strength (in increments of 10,000 psi [69Mpa] of weld metal with the flux and some specific classification of electrode deposited according to the welding conditions specified herein ,Two digits are used for weld metal of 100,000 psi(690 Mpa) tensile strength and higher – See Table. 7 AWS A5. 23 - 97
- ③ Designates the condition of heat treatment in which the test were conducted: “A” for as-welded and “P” for postweld heat treated. The time and temperature of the PWHT are specified herein
- ④ Indicates the lowest temperature at which the impact strenght of the weld metal referred to above meets or exceeds 20 ft-lb(27J)

# AWS Classification System

SAW

- ⑤ Indicates electrode
- ⑥ Indicates composite electrode, Omission of the “C” indicates solid electrode
- ⑦ Classification of the electrode used in depositing the weld metal referred to above – See Table 1
- ⑧ The “N” is used only when footnote C to Tables 1 and 2 apply – See Appendix A 2,2 for explanation
- ⑨ Indicates the chemical composition of the weld metal. One or more letters or digits are used – See Table 2

## Example

F9P0 - EB3 - B3 is a complete designation. It refers to a flux that will produce weld metal which, in the postweld heat - treated condition, will have a tensile strength no lower than 90,000 psi and Charpy V - notch impact strength of at least 20ft lb at 0°F when deposited with an EB3 electrode under the conditions called for in this specification/ The composition of the weld metal will be B3 (see Table 2)

**table 1** Composition Requirements for Electrodes

Electrode Class.	Chemical Composition, Percent											Remarks		
	C	Mn	Si	S	P	Cr	Ni	Mo	Cu	V	Al		Ti	Zr
EL12	0.04/0.14	0.25/0.60	0.10	0.030	0.030	-	-	-	0.35	-	-	-	-	carbon
EM12K	0.05/0.15	0.80/1.25	0.10/0.35	0.030	0.030	-	-	-	0.35	-	-	-	-	steel
EA1	0.07/0.17	0.65/1.00	0.20	0.030	0.025	-	-	0.45/0.65	0.35	-	-	-	-	
EA2	0.07/0.17	0.95/1.35	0.20	0.030	0.025	-	-	0.45/0.65	0.35	-	-	-	-	C-Mo
EA3	0.07/0.17	1.65/2.20	0.20	0.030	0.025	-	-	0.45/0.65	0.35	-	-	-	-	steel
EA4	0.07/0.17	1.20/1.70	0.20	0.030	0.025	-	-	0.45/0.65	0.35	-	-	-	-	
EB2	0.07/0.15	0.45/1.00	0.05/0.30	0.030	0.025	1.00/1.75	-	0.45/0.65	0.35	-	-	-	-	
EB2H	0.28/0.33	0.45/0.80	0.55/0.75	0.015	0.015	1.00/1.50	-	0.10/0.65	0.30	0.20/0.30	-	-	-	
EB3	0.05/0.15	0.40/0.80	0.05/0.30	0.025	0.025	2.25/3.00	-	0.90/1.10	0.35	-	-	-	-	Cr-Mo
EB5	0.18/0.23	0.40/0.70	0.40/0.60	0.025	0.025	0.45/0.65	-	0.90/1.10	0.35	-	-	-	-	steel
EB6	0.10	0.35/0.70	0.05/0.60	0.025	0.025	4.50/6.00	-	0.45/0.70	0.35	-	-	-	-	
EB6H	0.25/0.40	0.75/1.00	0.25/0.50	0.030	0.025	4.80/6.00	-	0.45/0.65	0.35	-	-	-	-	
ENi1	0.12	0.75/1.25	0.05/0.30	0.020	0.020	0.15	0.75/1.25	0.30	0.35	-	-	-	-	
ENi2	0.12	0.75/1.25	0.05/0.30	0.020	0.020	-	2.10/2.90	-	0.35	-	-	-	-	Ni steel
ENi3	0.13	0.60/1.20	0.05/0.30	0.020	0.020	0.15	3.10/3.80	-	0.35	-	-	-	-	
ENi4	0.12/0.19	0.60/1.00	0.10/0.30	0.020	0.015	-	1.60/2.10	0.10/0.30	0.35	-	-	-	-	
EF1	0.07/0.15	0.90/1.70	0.15/0.35	0.025	0.025	-	0.95/1.60	0.25/0.55	0.35	-	-	-	-	
EF2	0.10/0.18	1.70/2.40	0.20	0.025	0.025	-	0.40/0.80	0.40/0.65	0.35	-	-	-	-	

EF3	0.10/0.18	1.70/2.40	0.30	0.025	0.025	-	0.70/1.10	0.40/0.65	0.35	-	-	-	-	
EF4	0.16/0.23	0.60/0.90	0.15/0.35	0.035	0.025	0.10/0.60	0.10/0.80	0.15/0.30	0.35	-	-	-	-	
EF5	0.10/0.17	1.70/2.20	0.20	0.010	0.010	0.25/0.50	2.30/2.80	0.45/0.65	0.50	-	-	-	-	Other low
EF6	0.07/0.15	1.45/1.90	0.10/0.30	0.015	0.015	0.20/0.55	1.75/2.25	0.40/0.65	0.25	-	-	-	-	alloy steel
EM2	0.10	1.25/1.80	0.20/0.60	0.010	0.010	0.30	1.40/2.10	0.25/0.55	0.25	0.05	0.10	0.10	0.10	
EM3	0.10	1.40/1.80	0.20/0.60	0.010	0.010	0.55	1.90/2.60	0.25/0.65	0.25	0.04	0.10	0.10	0.10	
EM4	0.10	1.40/1.80	0.20/0.60	0.010	0.010	0.60	2.00/2.80	0.30/0.65	0.25	0.03	0.10	0.10	0.10	
EW	0.12	0.35/0.65	0.20/0.35	0.040	0.030	0.50/0.80	0.40/0.80	-	0.30/0.80	-	-	-	-	
EG	-	-	-	-	-	-	-	-	-	-	-	-	-	

**table 2** Chemical Composition Requirements for Solid Electrodes

Electrode Class.	Chemical Composition, Percent										Remarks
	C	Mn	Si	S	P	Cr	Ni	Mo	Cu	V,Ti,Zr	
A1	0.12	1.00	0.80	0.040	0.030	-	-	0.40/0.65	0.35	-	C-Mo steel
A2	0.12	1.40	0.80	0.040	0.030	-	-	0.40/0.65	0.35	-	
A3	0.15	2.10	0.80	0.040	0.030	-	-	0.40/0.65	0.35	-	
A4	0.15	1.60	0.80	0.040	0.030	-	-	0.40/0.65	0.35	-	
B2	0.15	1.20	0.80	0.010	0.030	1.00/1.50	-	0.40/0.65	0.35	-	Cr-Mo steel
B2H	0.10/0.25	1.20	0.80	0.040	0.030	1.00/1.50	-	0.40/0.65	0.35	0.30V	
B3	0.15	1.20	0.80	0.040	0.030	2.00/2.50	-	0.90/1.20	0.35	-	
B4	0.12	1.20	0.80	0.040	0.030	1.75/2.25	-	0.40/0.65	0.35	-	
B5	0.18	1.20	0.80	0.040	0.030	0.45/0.65	-	0.90/1.20	0.35	-	
B6	0.12	1.20	0.80	0.040	0.030	0.45/6.00	-	0.40/0.65	0.35	-	
B6H	0.10/0.25	1.20	0.80	0.040	0.030	0.45/6.00	-	0.40/0.65	0.35	-	
Ni1	0.12	1.60	0.80	0.030	0.030	0.15	0.75/1.10	0.35	0.35	0.05Ti	Ni steel
Ni2	0.12	1.60	0.80	0.030	0.030	-	2.00/2.90	-	0.35	-	
Ni3	0.12	1.60	0.80	0.030	0.030	0.15	2.80/3.80	-	0.35	-	
Ni4	0.14	1.60	0.80	0.030	0.030	-	1.40/2.10	0.35	0.35	-	
F1	0.12	0.70/1.50	0.80	0.040	0.030	0.15	0.90/1.70	0.55	0.35	-	Other low alloy steel
F2	0.17	1.25/2.25	0.80	0.040	0.030	-	0.40/0.80	0.40/0.65	0.35	-	
F3	0.17	1.25/2.25	0.80	0.040	0.030	-	0.70/1.10	0.40/0.65	0.35	-	
F4	0.17	1.60	0.80	0.040	0.030	0.60	0.40/0.80	0.25	0.35	0.03Ti	
F5	0.17	1.20/1.80	0.80	0.030	0.030	0.65	2.00/2.80	0.30/0.80	0.50	-	
F6	0.14	0.80/1.85	0.80	0.030	0.030	0.65	1.50/2.25	0.60	0.40	-	
M1	0.10	0.60/1.60	0.80	0.040	0.030	0.15	1.25/2.00	0.35	0.30	0.03Ti	
M2	0.10	0.90/1.80	0.80	0.040	0.030	0.35	1.40/2.10	0.25/0.65	0.30	0.03Ti	
M3	0.10	1.30/2.25	0.80	0.030	0.030	0.65	1.80/2.60	0.20/0.70	0.35	0.03Ti	
M4	0.10	0.50/1.60	0.80	0.040	0.030	0.80	2.00/2.80	0.30/0.80	0.30	0.03Ti	
W	0.12	0.50/1.60	0.80	0.040	0.030	0.45/0.70	0.40/0.80	-	0.30/0.75	-	
G	-	-	-	-	-	-	-	-	-	-	

# AWS Classification System

SAW

**table 3** Mechanical Property Requirements

AWS Classification	Tensile Strength (psi)	Yield Strength (psi)	Elongation (%)
F7XX-EXXX-X	70,000-95,000	≥58,000	≥22
F8XX-EXXX-X	80,000-100,000	≥68,000	≥20
F9XX-EXXX-X	90,000-110,000	≥78,000	≥17
F10XX-EXXX-X	100,000-120,000	≥88,000	≥16
F11XX-EXXX-X	110,000-130,000	≥98,000	≥15
F12XX-EXXX-X	120,000-140,000	≥108,000	≥14

**table 4** Impact Strength Requirements

Digit	Impact Values (ft-lb)	Digit	Impact Values (ft-lb)
Z	-	6	≥20(-60°F)
0	≥20(0°F)	8	≥20(-80°F)
2	≥20(-20°F)	10	≥20(-100°F)
4	≥20(-40°F)	15	≥20(-150°F)
5	≥20(-50°F)		

**table 5** Postweld Heat-treatment Temperature

Weld metal Classification	Postweld-Heat-Treatment-Temperature °F±25(°C±14)
F4, F5, F6	1050 (566)
M1, M2, M3, M4, W	1125 (607)
A1, A2, A3, A4, B1	
B2, B2H, B5, Ni1, Ni2	1150 (621)
Ni3, Ni4, F1, F2, F3	
B3, B4	1275 (691)
B6, B6H, B8	1375 (746)

# AWS Classification System

GMAW

## 1 AWS A 5.18

Specification for carbon steel electrodes and rods for gas shielded arc welding

E (ER)    XX    C(S) - X    Y    HZ  
 ①        ②        ③        ④        ⑤        ⑥

- ① Designates use as either an electrode or rod (ER), or use only as an electrode (E)
- ② Designates the minimum tensile strength
- ③ Indicates whether the filler metal is solid (S) or composite (C).
- ④ Indicates the chemical composition of a solid electrode or the chemical composition of the weld metal produced by a composite electrode. The use of the "GS" suffix designates filler metals intended for single pass applications only.
- ⑤ Indicates the type of shielding gas used for classification of composite electrodes.
- ⑥ Optional supplemental diffusible hydrogen designator.

**table 1** Chemical composition requirements for solid electrodes and rods : refer to Table as below

AWS Classifications		UNS Number	Weight Percent												
A5.18	A5.18M		C	Mn	Si	S	P	Ni	Cr	Mo	V	Cu	Ti	Zr	Al
ER70S-2	ER48S-2	K10726	0.07	0.90 to 1.40	0.45 to 0.70	0.025	0.035	0.15	0.15	0.15	0.03	0.50	0.05 to 0.15	0.02 to 0.12	0.05 to 0.15
ER70S-3	ER48S-3	K11022	0.06 to 0.15	0.90 to 1.40	0.45 to 0.75	0.025	0.035	0.15	0.15	0.15	0.03	0.50	-	-	-
ER70S-4	ER48S-4	K11132	0.06 to 0.15	1.00 to 1.50	0.65 to 0.85	0.025	0.035	0.15	0.15	0.15	0.03	0.50	-	-	-
ER70S-6	ER48S-6	K11140	0.06 to 0.15	1.40 to 1.85	0.80 to 1.15	0.025	0.035	0.15	0.15	0.15	0.03	0.50	-	-	-
ER70S-7	ER48S-7	K11125	0.07 to 0.15	1.5 0to 2.00	0.505 to 0.85	0.025	0.035	0.15	0.15	0.15	0.03	0.50	-	-	-
ER70S-G	ER48S-G	-	Not specified												

**table 2** Chemical composition requirements for weld metal from composite electrodes

AWS Classifications		UNS Number	Shielding Gas	Weight Percent										
A5.18	A5.18M			C	Mn	Si	S	P	Ni	Cr	Mo	V	Cu	
<b>Multiple Pass Classifications</b>														
E70C-3X	E-48C-3X	W07703	75-80% Ar/Balance CO <sub>2</sub> or CO <sub>2</sub>	0.12	1.75	0.90	0.03	0.03	0.50	0.20	0.30	0.08	0.50	
E70C-6X	E-48C-6X	W07706	75-80% Ar/Balance CO <sub>2</sub> or CO <sub>2</sub>	0.12	1.75	0.90	0.03	0.03	0.50	0.20	0.30	0.08	0.50	
E70C-G(X)	E-48C-G(X)	-	f	Not specified										
<b>Single Pass Classifications</b>														
E70C-GS(X)	E-48C-GS(X)	-	f	Not specified										

SMAW

SAW

GMAW

GTAW

FCAW

Non-FERROUS

APPENDIX

# AWS Classification System

GMAW

**table 3** Tension test requirements (As welded)

AWS Classification		Shielding Gas	Tensile Strength (minimum)		Yields Strength (minimum)		Elongation Percent (minimum)
A5.18	A5.18M		psi	Mpa	psi	Mpa	
ER70S-2	ER48S-2	CO <sub>2</sub>	70,000	480	58,000	400	22
ER70S-3	ER48S-3						
ER70S-4	ER48S-4						
ER70S-6	ER48S-6						
ER70S-7	ER48S-7						
ER70S-G	ER48S-G	d	70,000	480	58,000	400	22
E70C-3X	E48C-3X	75-80% Ar/Balance CO <sub>2</sub> or CO <sub>2</sub>	70,000	480	58,000	400	22
E70C-6X	E48C-6X						
E70C-G(X)	E48C-G(X)	d	70,000	480	58,000	400	22
E70C-GS(X)	E48C-GS(X)	d	70,000	480	Not specified		Not specified

**table 4** Impact test requirements (As welded)

AWS Classification		Average Impact Strength (minimum)	
A5.18	A5.18M	A5.18	A5.18M
ER70S-2	ER48S-2	20ft-lbf at -20°F	27 J at -30°C
ER70S-3	ER48S-3	20ft-lbf at 0°F	27 J at -20°C
ER70S-4	ER48S-4	Not Required	Not Required
ER70S-6	ER48S-6	20ft-lbf at -20°F	27 J at -30°C
ER70S-7	ER48S-7	20ft-lbf at -20°F	27 J at -30°C
ER70S-G	ER48S-G	As agreed between supplier and purchasers	
E-70C-G(X)	E-48C-G(X)	As agreed between supplier and purchasers	
E-70C-3X	E-48C-3X	20ft-lbf at 0°F	27 J at -20°C
E-70C-6X	E-48C-6X	20ft-lbf at -20°F	27 J at -30°C
E-70C-GS(X)	E-48C-GS(X)	Not Required	Not Required

## 2 AWS A 5.28

### Specification for low-alloy steel electrodes and rods for gas shielded arc welding

E(ER)    XX    X – X    HZ  
 ①        ②        ③        ④        ⑤

- ① Designates use as either electrode or rod (ER), or use only as an electrode (E)
- ② Tensile strength designator
- ③ Indicates whether the filler metal is solid (S) or composite stranded or metal cored (C)
- ④ Indicates the chemical composition of a solid electrode or the chemical composition of the weld metal produced by a composite electrode
- ⑤ Optional supplemental diffusible hydrogen designator

**table 1** Chemical composition requirements for solid electrodes and rods

AWS Classifications		UNS Number	Weight Percent													
A5.28	A5.28M		C	Mn	Si	P	S	Ni	Cr	Mo	V	Ti	Zr	Al	Cu	Other Elements Total
<b>Carbon-Molybdenum Steel Electrodes and Rods</b>																
ER70S-A1	ER49S-A1	K11235	0.12	1.30	0.30-0.70	0.025	0.025	0.20	-	0.40-0.65	-	-	-	-	0.35	0.50
<b>Chromium-Molybdenum Steel Electrodes and Rods</b>																
ER80S-B2	ER55S-B2	K20900	0.07-0.12	0.40-0.70	0.40-0.70	0.025	0.025	0.20	1.20-1.50	0.40-0.65	-	-	-	-	0.35	0.50
ER70S-B2L	ER49S-B2L	K20500	0.05	0.40-0.70	0.40-0.70	0.025	0.025	0.20	1.20-1.50	0.40-0.65	-	-	-	-	0.35	0.50
ER90S-B3	ER62S-B3	K30960	0.07-0.12	0.40-0.70	0.40-0.70	0.025	0.025	0.20	2.30-2.70	0.90-1.20	-	-	-	-	0.35	0.50
ER80S-B3L	ER55S-B3L	K30560	0.05	0.40-0.70	0.40-0.70	0.025	0.025	0.20	2.30-2.70	0.90-1.20	-	-	-	-	0.35	0.50
ER80S-B6	ER55S-B6	K50280	0.10	0.40-0.70	0.50	0.025	0.025	0.60	4.50-6.00	0.45-0.65	-	-	-	-	0.35	0.50
ER80S-B8	ER55S-B8	K50480	0.10	0.40-0.70	0.50	0.025	0.025	0.50	8.00-10.50	0.80-1.20	-	-	-	-	0.35	0.50
ER90S-B9	ER62S-B9	K50482	0.07-0.13	1.20	0.15-0.50	0.010	0.010	0.80	8.00-10.50	0.850-1.20	0.15-0.30	-	-	0.04	0.20	0.50
<b>Nickel Steel Electrodes and Rods</b>																
ER80S-Ni1	ER55S-Ni1	K11260	0.12	1.25	0.40-0.80	0.025	0.025	0.80-1.10	0.15	0.35	0.05	-	-	-	0.35	0.50
ER80S-Ni2	ER55S-Ni2	K21240	0.12	1.25	0.40-0.80	0.025	0.025	2.00-2.75	-	-	-	-	-	-	0.35	0.50
ER80S-Ni3	ER55S-Ni3	K31240	0.12	1.25	0.40-0.80	0.025	0.025	3.00-3.75	-	-	-	-	-	-	0.35	0.50

# AWS Classification System

GMAW

Manganese-Molybdenum Steel electrodes and Rods																
ER80S-D2	ER55S-D2	K10945	007-0.12	1.60-2.10	0.50-0.80	0.025	0.025	0.15	-	0.40-0.60	-	-	-	-	0.50	0.50
ER90S-D2	ER62S-D2															
Other Low-Alloy Steel Electrodes and Rods																
ER100S-1	ER69S-1	K10882	0.08	1.25-1.80	0.20-0.55	0.010	0.010	1.40-2.10	0.30	0.25-0.55	0.05	0.10	0.10	0.10	0.25	0.50
ER110S-1	ER76S-1	K21015	0.09	1.40-1.80	0.20-0.55	0.010	0.010	1.90-2.60	0.50	0.25-0.55	0.04	0.10	0.10	0.10	0.25	0.50
ER120S-1	ER83S-1	K21030	0.10	1.40-1.80	0.25-0.60	0.010	0.010	2.00-2.80	0.60	0.30-0.65	0.03	0.10	0.10	0.10	0.25	0.50
ERXXS-G	ERXXS-G	-	Not specified													

**table 2** Chemical composition requirements for weld metal from composite electrodes

AWS Classifications		UNS Number	Weight Percent													
A5.28	A5.28M		C	Mn	Si	P	S	Ni	Cr	Mo	V	Ti	Zr	Al	Cu	Other Elements Total
Chromium-Molybdenum Weld Metal																
E80C-B2	E55C-B2	W52030	0.05-0.12	0.40-1.00	0.25-0.60	0.025	0.030	0.20	1.00-1.50	0.40-0.65	0.03	-	-	-	-	0.50
E70C-B2L	E49C-B2L	W52130	0.05	0.40-1.00	0.25-0.60	0.025	0.030	0.20	1.00-1.50	0.40-0.65	0.03	-	-	-	0.35	0.50
E90C-B3	E62C-B3	W53030	0.05-0.12	0.40-1.00	0.25-0.60	0.025	0.030	0.20	2.00-2.50	0.90-1.20	0.03	-	-	-	0.35	0.50
E80C-B3L	E55C-B3L	W53130	0.05	0.40-1.00	0.25-0.60	0.025	0.030	0.20	2.00-2.50	0.90-1.20	0.03	-	-	-	0.35	0.50
E80C-B6	E55C-B6		0.10	0.40-1.00	0.25-0.60	0.025	0.025	0.60	4.50-6.00	0.45-0.65	0.03	-	-	-	0.35	0.50
E80C-B8	E55C-B8		0.10	0.40-1.00	0.25-0.60	0.025	0.025	0.20	8.00-10.50	0.80-1.20	0.03	-	-	-	0.35	0.50
E80C-B9	E55C-B9		0.08-0.13	1.20	0.50	0.020	0.015	0.80	8.00-10.50	0.85-1.20	0.15-0.30	-	-	0.04	0.20	0.50
Nickel Steel Electrodes and Rods																
E80C-Ni1	E55C-Ni1	W21030	0.12	1.50	0.90	0.025	0.030	0.80-1.10	-	0.30	0.03	-	-	-	0.35	0.50
E70C-Ni2	E49C-Ni2	W22030	0.08	1.25	0.90	0.025	0.030	1.75-2.75	-	-	0.03	-	-	-	0.35	0.50
E80C-Ni2	E55C-Ni2	W22030	0.12	1.50	0.90	0.025	0.030	1.75-2.75	-	-	0.03	-	-	-	0.35	0.50
E80C-Ni3	E55C-Ni3	W23030	0.12	1.50	0.90	0.025	0.030	2.75-3.75	-	-	0.03	-	-	-	0.35	0.50



Manganese-Molybdenum Steel Electrodes and Rods																
E90C-D2	E62C-D2	W19230	0.12	1.00-1.90	0.90	0.025	0.030	-	-	0.40-0.60	0.03	-	-	-	0.35	0.50
Other Low-Alloy Steel Electrodes and Rods																
E90C-K3	E62C-K3		0.15	0.75-2.25	0.80	0.025	0.025	0.50-2.50	0.15	0.25-0.65	0.03	-	-	-	0.35	0.50
E100C-K3	E69C-K3		0.15	0.75-2.25	0.80	0.025	0.025	0.50-2.50	0.15	0.25-0.65	0.03	-	-	-	0.35	0.50
E110C-K3	E76C-K3		0.15	0.75-2.25	0.80	0.025	0.025	0.50-2.50	0.15	0.25-0.65	0.03	-	-	-	0.35	0.50
E110C-K4	E76C-K4		0.15	0.75-2.25	0.80	0.025	0.025	0.50-2.50	0.15-0.65	0.25-0.65	0.03	-	-	-	0.35	0.50
E120C-K4	E83C-K4		0.15	0.75-2.25	0.80	0.025	0.025	0.50-2.50	0.15-0.65	0.25-0.65	0.03	-	-	-	0.35	0.50
E80C-W2	E55C-W2		0.12	0.50-1.30	0.35-0.80	0.025	0.030	0.40-0.80	0.45-0.70	-	0.03	-	-	-	0.30-0.75	0.50
EXXC-G	EXXC-G	-	Not specified													

table 3 Tension test requirements

AWS Classification		Shielding Gas	Tensile Strength (minimum)		Yields Strength (minimum)		Elongation Percent (minimum)	Testing Condition							
A5.28	A5.28M		psi	Mpa	psi	Mpa									
ER70S-B2L	ER49S-B2L	Argon/1-5% O <sub>2</sub> (Classes SG-A0-1 thru SG-A0-5)	75,000	515	58,000	400	19	PWHT							
ER70C-B2L	E49C-B2L														
ER70S-A1	ER49S-A1														
ER80S-B2	ER55S-B2														
E80C-B2	E55C-B2														
ER80S-B3L	ER55S-B3L														
E80C-B3L	E55S-B3L														
ER90S-B3	ER62S-B3														
E90C-B3	E62C-B3														
ER80S-B6	ER55S-B6	Argon/5% CO <sub>2</sub> (Class SG-AC-5)	80,000	550	68,000	470	17	PWHT							
E80C-B6	E55C-B6														
ER80S-B8	ER55S-B8														
E80C-B8	E55C-B8														
ER90S-B9	ER62S-B9								Argon/5-25% CO <sub>2</sub> (Classes SG-AC-5 thru SG-AC-25)	90,000	620	60,000	410	16	PWHT
E90C-B9	E62C-B9														

# AWS Classification System

GMAW

ER70C-Ni2	E49C-Ni2	Argon/1-5% O <sub>2</sub> (Classes SG-AO-1 thru SG-AO-5)	70,000	480	58,000	400	24	PWHT
ER80S-Ni1 E80C-Ni1	ER55S-Ni1 E55C-Ni1		80,000	550	68,000	470	24	As-Welded
ER80S-Ni2 E80C-Ni2 ER80S-Ni3 E80C-Ni3	ER55S-Ni2 E55C-Ni2 ER55S-Ni3 E55C-Ni3		80,000	550	68,000	470	24	PWHT
ER80S-D2	ER55S-D2	CO <sub>2</sub> (Classes SG-C)	80,000	550	68,000	470	17	As-Welded
ER90S-D2 E90C-D2	ER62S-D2 E62C-D2	Argon/1-5% O <sub>2</sub> (Classes SG-AO-1 thru SG-AO-5)	90,000	620	78,000	540	17	As-Welded
ER100S-1	ER69S-1	Argon/2% O <sub>2</sub> (Class SG-AO-2)	100,000	690	88,000	610	16	As-Welded
ER110S-1	ER76S-1		110,000	760	95,000	660	15	
ER120S-1	ER83S-1		120,000	830	105,000	730	14	
E90C-K3	E62C-K3	Argon/5-25% CO <sub>2</sub> (Classes SG-AC-5 thru SG-AC-25)	90,000	620	78,000	540	18	As-Welded
E100C-K3	E69C-K3		100,000	690	88,000	610	16	
E110C-K3 E110C-K4	E76C-K3 E76C-K4		110,000	710	98,000	680	15	
E120C-K4	E83C-K4		120,000	830	108,000	750	15	
E80C-W2	E55C-W2		80,000	550	68,000	470	22	
ER70S-G E70C-G		(d)	70,000	480	(e)	(e)	(e)	(e)
ER80S-G E80C-G		(d)	80,000	550	(e)	(e)	(e)	(e)
ER90S-G E90C-G		(d)	90,000	620	(e)	(e)	(e)	(e)
ER100S-G E100C-G		(d)	100,000	690	(e)	(e)	(e)	(e)
ER110S-G E110C-G		(d)	110,000	760	(e)	(e)	(e)	(e)
ER120S-G E120C-G		(d)	120,000	830	(e)	(e)	(e)	(e)

table 4 Impact test requirements

AWS Classification		Average Impact Energy Absorber <sup>a,b</sup> (minimum)		Testing Condition
A5.28	A5.28M	A5.28	A5.28M	
ER70S-A1	ER49S-A1	Not Required	Not Required	-
ER70S-B2L	ER49S-B2L			
E70C-B2L	E49C-B2L			
ER80S-B2	ER55S-B2			
E80C-B2	E55C-B2			
ER80S-B3L	ER55S-B3L			
E80C-B3L	E55S-B3L			
ER90S-B3	ER62S-B3			
E90C-B3	E62C-B3			
ER80S-B6	ER55S-B6			
E80C-B6	E55C-B6			
ER80S-B8	ER55S-B8			
E80C-B8	E55C-B8			
ER90S-B9	ER62S-B9			
E90C-B9	E62C-B9			
ER80S-Ni1	ER55S-Ni1			
E80C-Ni1	E55C-Ni1	20ft-lbf at -80°F	27 J at -60°C	PWHT <sup>b</sup>
E70C-Ni2	E49C-Ni2			
ER80S-Ni2	ER55S-Ni2			
E80C-Ni2	E55C-Ni2	20ft-lbf at -100°F	27 J at -75°C	PWHT <sup>b</sup>
ER80S-Ni3	ER55S-Ni3			
E80C-Ni3	E55C-Ni3			
ER80S-D2	ER55S-D2	20ft-lbf at -20°F	27 J at -30°C	As-Welded
ER90S-D2	ER62S-D2			
E90C-D2	E62C-D2			
ER100S-1	ER69S-1	50ft-lbf at -60°F	27 J at -50°C	As-Welded
ER110S-1	ER76S-1			
ER120S-1	ER83S-1			
E90C-K3	E62C-K3	20ft-lbf at -60°F	27 J at -50°C	As-Welded
E100C-K3	E69C-K3			
E110C-K3	E76C-K3			
E110C-K4	E76C-K4			
E120C-K4	E83C-K4			
E80C-W2	E55C-W2	20ft-lbf at -20°F	27 J at -30°C	As-Welded
ERXXS-G	ERXXS-G	As agreed between supplier and purchasers	As agreed between supplier and purchasers	-
EXXC-G	EXXC-G			-

# AWS Classification System

FCAW

## 1 AWS A 5.20

Specification for carbon steel electrodes for Flux Cored Arc Welding

E    X    X    T – X    X – J    X    HX  
 ①    ②    ③    ④    ⑤    ⑥    ⑦    ⑧    ⑨

- ① Designates an electrode
- ② Tensile strength designator
- ③ Welding position designator (“0” is for flat and horizontal position only, “1” is for all positions)
- ④ This designator identifies the electrode as a flux cored electrode
- ⑤ Usability designator
- ⑥ Shielding gas designator
- ⑦ The letter “J” designates that the electrodes meet the requirements for improved toughness (27J at -40°C)
- ⑧ The letter “D” or “Q” when present in this position indicates that the weld metal will meet supplemental mechanical property requirements with welding done using low heat input and high heat input – See Table 2, 3
- ⑨ Optional supplemental diffusible hydrogen designator – See Table 1

table 1 Optional hydrogen limits for weld metal<sup>a</sup>

Optional Supplemental Diffusible Hydrogen Designator	Average Diffusible Hydrogen Max. mL/100g Deposited Metal
H16	16.0
H8	8.0
H4	4.0

table 2 Procedure requirements for “D” and “Q” optional supplemental designators

Optional Supplemental Designator	Procedure Heat Input (Fast or Slow Cooling Rate)	Preheat Temperature °F(°C)	Interpass Temperature °F(°C)	Heat Input Requirement for Any Single Pass	Required Average Heat Input for All Passes
D	Low (Fast cooling rate)	70° ± 25°F [20° ± 15°C]	200° ± 25°F [90° ± 15°C]	For electrode diameters < 3/32 in. [2.4mm]	
				33 kJ/in. [1.3 kJ/mm] maximum	30 + 2, -5 kJ/in. [1.2 + 0.1, -0.2 kJ/mm]
				For electrode diameters < 3/32 in. [2.4mm]	
				44 kJ/in. [1.7 kJ/mm] minimum	40 + 2, -5 kJ/in. [1.6 + 0.1, -0.2 kJ/mm]

Q	High (Slow cooling rate)	300° ± 25°F [150° ± 15°C]	500° ± 50°F [260° ± 25°C]	75 kJ/in. [3.0 kJ/mm] minimum	80 + 5, -2 kJ/in. [3.1 + 0.2, -0.1 kJ/mm]
	Low (Fast cooling rate)	70° ± 25°F [20° ± 15°C]	150°F max. [65°C max.]	33 kJ/in. [1.3 kJ/mm] minimum	30 + 2, -5 kJ/in. [1.2 + 0.1, -0.2 kJ/mm]
	High (Slow cooling rate)	300° ± 25°F [150° ± 15°C]	300° ± 25°F [150° ± 15°C]	60 kJ/in. [2.4 kJ/mm] minimum	70 + 5, -2 kJ/in. [2.8 + 0.2, -0.1 kJ/mm]

**table 3** Mechanical property requirements for “D” and “Q” optional supplemental designators

Optional Supplemental Designator	Tensile Test Requirements	Minimum Charpy V-Notch Requirements
D	58 ksi[400 MPa] min. yield strength 70 ksi[490 MPa] min. tensile strength 22% min. elongation in 2 in. [50 mm]	40 ft-lbf at +70°F [54J at +20°C]
Q	58 to 80 ksi[400-550 MPa] yield strength for high heat input, slow cooling rate test 90 ksi[620 MPa] max. yield strength for low heat input, fast cooling rate test 22% min. elongation in 2 in. [50mm] (see Note c)	20 ft-lbf at -20°F [27J at -30°C]

## 2 AWS A 5.29

### Specification for low-alloy steel electrodes for Flux Cored Arc Welding

E   X   X   T   X - X   X - J   HX  
 ①   ②   ③   ④   ⑤   ⑥   ⑦   ⑧   ⑨

- ① Designates an electrode
- ② Tensile strength designator – See Table 1
- ③ Welding position designator (“0” is for flat and horizontal position only, “1” is for all positions)
- ④ This designator identifies the electrode as a flux cored electrode
- ⑤ Usability designator
- ⑥ Deposit composition designator - See Table 2
- ⑦ Shielding gas designator
- ⑧ The letter “J” designates that the electrodes meet the requirements for improved toughness (27J at -40°C)
- ⑨ Optional supplemental diffusible hydrogen designator – See Table 3

# AWS Classification System

FCAW

**table 1** A5.29 Mechanical property requirements

AWS Classification(s)	Condition	Tensile Strength (ksi)	Yield Strength (ksi)	Elongation Minimum (%)	Charpy V-Notch Impact Energy Minimum
E8XT1-K2C, -K2M E8XT5-K2C, -K3M	AW	80-100	68 min.	19	20 ft-lbf @-20°F
E9XT1-K2C, -K4M	AW	90-110	78 min.	17	20 ft-lbf @0°F
E9XT5-K2C, -K5M	AW	90-110	78 min.	17	20 ft-lbf @-60°F
E10XT1-K3C, -K3M	AW	100-120	88 min.	16	20 ft-lbf @0°F
E10XT5-K3C, -K4M	AW	100-120	88 min.	16	20 ft-lbf @-60°F
E11XT1-K3C, -K3M	AW	110-130	98 min.	15	20 ft-lbf @0°F
E11XT5-K3C, -K4M	AW	110-130	98 min.	15	20 ft-lbf @-60°F
E11XT1-K4C, -K4M	AW	110-130	98 min.	15	20 ft-lbf @0°F
E11XT5-K4C, -K4M	AW	110-130	98 min.	15	20 ft-lbf @-60°F
E12XT5-K4C, -K4M	AW	120-140	108 min.	14	20 ft-lbf @-60°F
E12XT1-K5C, -K5M	AW	120-140	108 min.	14	Not-specified
E7XT5-K6C, -K6M	AW	70-90	58 min.	20	20 ft-lbf @-75°F
E6XT8-K6	AW	60-80	50 min.	22	20 ft-lbf @-20°F
E7XT8-K6	AW	70-90	58 min.	20	20 ft-lbf @-20°F
E10XT1-K7C, -K7M	AW	100-120	88 min.	16	20 ft-lbf @-60°F
E9XT8-K8	AW	90-110	78 min.	17	20 ft-lbf @-20°F
E10XT1-K9C, -K9M	AW	100-120	82-97	18	35 ft-lbf @-60°F
E8XT1-W2C, -W2M	AW	80-100	68 min.	19	20 ft-lbf @-20°F
EXXTX-G,-GC,-GM	The weld deposit composition, condition of test (AW or PWHT) and Charpy V-Notch impact properties are as agreed upon between the supplier and purchaser. Requirements for the tension test, positionality, slag system and shielding gas, if any, conform to those indicated by the digits used.				
EXXTX-X	The slag system, shielding gas, if any, condition of test (AW or PWHT) and Charpy V-Notch impact properties are as agreed upon between the supplier and purchaser. Requirements for the tension test, positionality and weld deposit composition conform to those indicated by the digits used.				
EXXTG-G	The slag system, shielding, if any, condition of test (AW or PWHT) and Charpy V-Notch impact properties and weld deposit composition are as agreed upon between the supplier and purchaser. Requirements for the tension test and positionality conform to those indicated by the digits used.				

**table 2** Weld metal chemical composition requirements for classification to AWS A5.29/A5.29M (cont'd)

Weld Metal Designation	UNS Number	Weight Percent											
		C	Mn	P	S	Si	Ni	Cr	Mo	V	Al	Cu	Other
<b>Other Low-Alloy Steel Electrodes</b>													
K1	W2113X	0.15	0.80~1.40	0.030	0.030	0.80	0.80~1.10	0.15	0.20~0.65	0.05	-	-	-
K2	W2123X	0.15	0.50~1.75	0.030	0.030	0.80	1.00~2.00	0.15	0.35	0.05	1.8	-	-
K3	W2133X	0.15	0.75~2.25	0.030	0.030	0.80	1.25~2.60	0.15	0.25~0.65	0.05	-	-	-
K4	W2233X	0.15	1.20~2.25	0.030	0.030	0.80	1.75~2.60	0.20~0.60	0.20~0.65	0.03	-	-	-
K5	W2162X	0.10~0.25	0.60~1.60	0.030	0.030	0.80	0.75~2.00	0.20~0.70	0.15~0.55	0.05	-	-	-
K6	W2104X	0.15	0.50~1.50	0.030	0.030	0.80	0.40~1.00	0.20	0.15	0.05	1.8	-	-
K7	W2205X	0.15	1.00~1.75	0.030	0.030	0.80	2.00~2.75	-	-	-	-	-	-
K8	W2143X	0.15	1.00~2.00	0.030	0.030	0.40	0.50~1.50	0.20	0.20	0.05	1.8	-	-
K9	W23230	0.07	0.50~1.50	0.015	0.015	0.60	1.30~3.75	0.20	0.50	0.05	-	0.06	-
W2	W2013X	0.12	0.50~1.30	0.030	0.030	0.35~0.80	0.40~0.80	0.45~0.70	-	-	-	0.30~0.75	-
G	-	-	0.50	0.030	0.030	1.00	0.50	0.30	0.20	0.10	1.8	-	-

**table 3** Diffusible hydrogen limits for weld metal

Optional Supplemental Diffusible Hydrogen Designator	Average Diffusible Hydrogen Max. mL/100g Deposited Metal
H16	16.0
H8	8.0
H4	4.0

# EN Classification System

## 1 EN 10204 : Metallic products – Type of inspection documents

### General

1. This document specifies the different types of inspection documents supplied to the purchaser, in accordance with the requirements of the order, for the delivery of all metallic products e.g. plates, sheets, bars, forgings, castings, whatever their method of production
2. This document may also apply to non-metallic products
3. This document is used in conjunction with the product specifications which specify the technical delivery conditions of the products.

EN 10204 Reference	Designation of the document type	Document content	Document Validated by
Type 2.1	Declaration of Compliance with the order	Statement of Compliance with the order	The manufacturer
Type 2.2	Test report	Statement of Compliance with the order, With Indication of results of non-specific inspection	The manufacturer
Type 3.1	Inspection Certificate 3.1	Statement of compliance with the order, with Indication of results of Specific inspection	The manufacturer's authorized inspection representative independent of the manufacturing department
Type 3.2	Inspection Certificate 3.2	Statement of compliance with the order, with indication of results of specific inspection	The manufacturer's authorized inspection representative independent of the manufacturing department and either the purchaser's authorized inspection representative or the inspector designated by the official regulations

## 2 EN ISO 2560 : 2005

Welding consumables – Covered electrodes for manual metal arc welding of non-alloy and Fine grain steels – Classification

ISO 2560 – A – E 46 3 1Ni B 5 4 H5  
 ① ② ③ ④ ⑤ ⑥ ⑦ ⑧

- ① Covered electrode/manual metal arc welding
- ② Strength and elongation – See Table 4
- ③ Impact properties – See Table 5



- ④ Chemical composition of all-weld metal – See Table 3
- ⑤ Type of electrode covering – See table 1
- ⑥ Nominal electrode efficiency and type of current
- ⑦ Welding position – See Table 2
- ⑧ Hydrogen content – See Table 6

table 1

Symbol	Type of covering
A	Acid covering
C	Cellulosic covering
B	Basic covering
R	Rutile covering
⋮	⋮

table 3

Symbol	Chemical composition		
	Mn	Mo	Ni
No Symbol	2.0	-	-
Mo	1.4	0.3~0.6	-
MnMo	1.4~2.0	0.3~0.6	-
1Ni	1.4	-	0.6~1.2

table 4

Symbol	Minimum Yield strength (MPa)	Tensile Strength (MPa)	Minimum Elongation (%)
35	355	440~570	22
38	380	470~600	20
42	420	500~640	20
46	460	530~680	20
50	500	560~720	18

table 5

Symbol	Test temperature (°C)
0	0
2	-20
3	-30
4	-40
5	-50
⋮	⋮

table 2

Symbol	Welding position
1	PA, PB, PC, PD, PE, PF & PG
2	PA, PB, PC, PD, PE & PF
3	PA & PB
4	PA
5	PA, PB & PG

PA = Flat position

PB = Horizontal vertical position

PC = Horizontal position

PD = Horizontal overhead position

PE = Overhead position

PF = Vertical up position

PG = Vertical down position

table 6

Symbol	Hydrogen content (ml/100g)
H5	5
H10	10
H15	15

# EN Classification System

## 3 EN ISO 17632 : 2008

Welding consumables – Tubular cored electrodes for gas shielded and non-gas shielded metal arc welding of non-alloy and fine grain steels – classification

ISO 17632 – A – T   46   3   1Ni   B   M   1   H5  
                   ①      ②      ③      ④      ⑤      ⑥      ⑦      ⑧

- ① Indicates a tubular cored electrode/metal arc welding
- ② Represents the tensile properties – See Table 2
- ③ Indicates impact properties of 47J, minimum – See Table 3
- ④ Chemical composition of all-weld metal – See Table 1
- ⑤ Type of electrode core – See Table 6
- ⑥ Shielding gas
- ⑦ Welding position – See Table 4
- ⑧ Hydrogen content – See Table 5

table 1

Composition Designation	Chemical composition (%)											
	C	Mn	Si	P	S	Cr	Ni	Mo	V	Nb	Al	Cu
No Symbol	-	2.0	-	-	-	0.2	0.5	0.2	0.08	0.05	2.0	0.3
Mo	-	1.4	-	-	-	0.2	0.5	0.3-0.6	0.08	0.05	2.0	0.3
MnMo	-	1.4-2.0	-	-	-	0.2	0.5	0.3-0.6	0.08	0.05	2.0	0.3
1Ni	-	1.4	0.80	-	-	0.2	0.6-1.2	0.2	0.08	0.05	2.0	0.3
1.5Ni	-	1.6	-	-	-	0.2	1.2-1.8	0.2	0.08	0.05	2.0	0.3
2Ni	-	1.4	-	-	-	0.2	1.8-2.6	0.2	0.08	0.05	2.0	0.3
3Ni	-	1.4	-	-	-	0.2	2.6-3.8	0.2	0.08	0.05	2.0	0.3
⋮												

table 2

Symbol	Minimum Yield strength (MPa)	Tensile Strength (MPa)	Minimum Elongation (%)
35	355	440-570	22
38	380	470-600	20
42	420	500-640	20
46	460	530-680	20
50	500	560-720	18

table 3

Symbol	Test temperature (°C)
0	0
2	-20
3	-30
4	-40
5	-50
⋮	⋮

table 5

Symbol	Hydrogen content (ml/100g)
H5	5
H10	10
H15	15

table 6

Symbol	Characteristics	Type of weld
R	Rutile, Slow freezing slag	Single, multiple pass
P	Rutile, Fast freezing slag	Single, multiple pass
B	Basic	Single, multiple pass
M	Metal powder	Single, multiple pass
⋮	⋮	⋮

table 4

Symbol	Welding position
1	PA, PB, PC, PD, PE, PF & PG
2	PA, PB, PC, PD, PE & PF
3	PA & PB
4	PA
5	PA, PB & PG

PA = Flat position

PB = Horizontal vertical position

PC = Horizontal position

PD = Horizontal overhead position

PE = Overhead position

PF = Vertical up position

PG = Vertical down position

# EN Classification System

## 4 EN ISO 14341 : 2011

Welding consumables – Wire electrodes and weld deposits for gas shielded metal arc welding of non alloy and fine grain steels – Classification

ISO 14341 – A – G    46    5    M21    3Si1  
                           ①        ②        ③        ④        ⑤

- ① Designates a wire electrode and/or deposit produced by gas shielded metal arc welding
- ② Strength and elongation – See Table 2
- ③ Impact properties – See Table 3
- ④ Shielding gas
- ⑤ Chemical composition of the wire electrode – See Table 1

table 1

Composition Designation	Chemical composition (%)											
	C	Si	Mn	P	S	Ni	Cr	Mo	V	Cu	Al	Ti+Zr
2Si	0.06-0.14	0.50-0.80	0.90-1.30	0.025	0.025	0.15	0.15	0.15	0.03	0.35	0.02	0.15
3Si1	0.06-0.14	0.70-1.00	1.30-1.60	0.025	0.025	0.15	0.15	0.15	0.03	0.35	0.02	0.15
3Si2	0.06-0.14	1.00-1.30	1.30-1.60	0.025	0.025	0.15	0.15	0.15	0.03	0.35	0.02	0.15
4Si1	0.06-0.14	0.80-1.20	1.60-1.90	0.025	0.025	0.15	0.15	0.15	0.03	0.35	0.02	0.15
2Ti	0.04-0.14	0.40-0.80	0.90-1.40	0.025	0.025	0.15	0.15	0.15	0.03	0.35	0.05-0.20	0.05-0.25
2Al	0.08-0.14	0.30-0.50	0.90-1.30	0.025	0.025	0.15	0.15	0.15	0.03	0.35	0.35-0.75	0.15
3Ni1	0.06-0.14	0.50-0.90	1.00-1.60	0.020	0.020	0.80-1.50	0.15	0.15	0.03	0.35	0.02	0.15
⋮												

table 2

Symbol	Minimum Yield strength (MPa)	Tensile Strength (MPa)	Minimum Elongation (%)
35	355	440-570	22
38	380	470-600	20
42	420	500-640	20
46	460	530-680	20
50	500	560-720	18

table 3

Symbol	Test temperature (°C)
0	0
2	-20
3	-30
4	-40
5	-50
⋮	⋮

## 5 EN ISO 14171 : 2011

Welding consumables – Solid wire electrodes, tubular cored electrodes and electrode/flux  
Combinations for submerged arc welding of non alloy and fine grain steels - Classification

ISO 14171 – A – S    46    3    AB    S2  
                           ①        ②        ③        ④        ⑤

- ① Electrode/flux combination for submerged arc welding
- ② Indicates the tensile properties – See Table 2
- ③ Indicates the impact properties – See Table 3
- ④ Type of welding flux (Refer to EN 14174)
- ⑤ Chemical composition of the wire electrode – See Table 1

table 1

Composition Designation	Chemical composition (%)								
	C	Si	Mn	P	S	Mo	Ni	Cr	Cu
S1	0.05-0.15	0.15	0.35-0.60	0.025	0.025	0.15	0.15	0.15	0.30
S2	0.07-0.15	0.15	0.80-1.30	0.025	0.025	0.15	0.15	0.15	0.30
S3	0.07-0.15	0.15	1.30-1.75	0.025	0.025	0.15	0.15	0.15	0.30
S4	0.07-0.15	0.15	1.75-2.25	0.025	0.025	0.15	0.15	0.15	0.30
S1Si1	0.07-0.15	0.15-0.40	0.35-0.60	0.025	0.025	0.15	0.15	0.15	0.30
S2Si1	0.07-0.15	0.15-0.40	0.80-1.30	0.025	0.025	0.15	0.15	0.15	0.30
S2Si2	0.07-0.15	0.40-0.60	0.80-1.30	0.025	0.025	0.15	0.15	0.15	0.30
⋮	⋮	⋮	⋮	⋮	⋮	⋮	⋮	⋮	⋮

table 2

Symbol	Minimum Yield strength (MPa)	Tensile Strength (MPa)	Minimum Elongation (%)
35	355	440-570	22
38	380	470-600	20
42	420	500-640	20
46	460	530-680	20
50	500	560-720	18

table 3

Symbol	Test temperature (°C)
0	0
2	-20
3	-30
4	-40
5	-50
⋮	⋮

# Standards of welding consumables

Classification Society

## 1 Flux covered arc welding rods for mild and high tensile steel

Approvals	Steel type	Yield point (N/mm <sup>2</sup> )	Tensile strength (N/mm <sup>2</sup> )	EL (%)	Impact value			Hydrogen contents (ml/100gr)
					Grade	°C	J	
KR	Mild steel	≥305	400-560	≥22	RMW1 RMW2 RMW3	20 0 -20	≥47(≥34)	Glycerin method ≤0.10H ≤0.05HH Mercury method ≤0.15H 0.08HH
	YP32,38 High tensile steel	≥375	490-660	≥22	RMW52 RMW53	0 -20	≥47(≥34)	
	YP50 High tensile steel	≥490	570-730	≥20	RMW61 RMW62 RMW63	0 -20 -30	≥47(≥34)	
ABS	Mild steel	≥305	400-655		1 2 3	20 0 -20 or -10	≥47(≥34) or ≥61	Glycerin method ≤0.10H ≤0.05H Mercury method ≤0.16H ≤0.08HH
	YP32,38 High tensile steel	≥370	490-655		1Y 2Y 3Y	20 or 0 0 or -20 -20 or -40	≥54(≥34) or ≥27	
LR	Mild steel	≥305	400-560		1 2 3	20 0 -20	≥47(≥34)	Glycerin method ≥0.1H Mercury method ≥0.15H
	YP32,38 High tensile steel	≥375	460-660		2Y 3Y	0 -20		
BV	Mild steel	≥305	400-560		1 2 3	20 0 -20	≥47(≥34)	Glycerin method ≤0.1H ≤0.05HH Mercury method ≤0.15H 0.08HH ≤0.05HH
	YP32,38 High tensile steel	≥375	490-660		2Y 3Y	0 -20		
DNV	Mild steel	≥305	400-560		1 2 3	20 0 -20	≥47(≥34)	Glycerin method ≤0.1H15 ≤0.05H10 Mercury method ≤0.15H15 ≤0.10H10 ≤0.05H5
	YP32,38 High tensile steel	≥375	490-660		2Y 3Y 4Y 5Y	0 -20 -40 -60		
	YP40 High tensile steel	≥400	510-690		2Y40 3Y40 4Y40	0 -20 -40	≥47(≥41)	
NK	Mild steel	≥305	400-560	≥22	KMW1 KMW2 KMW3	20 0 -20	≥47(≥34)	Glycerin method ≤0.1H15 ≤0.05H10 Mercury method ≤0.15H15 ≤0.10HH10
	YP32,38 High tensile steel	≥375	490-660		KMW52 KMW53 KMW54	0 -20 -40		
	YP40 High tensile steel	≥400	510-690		KMW52Y40 KMW53Y40 KMW54Y40	0 -20 -40	≥47(≥41)	

Remark: ( ) value in impact value blank appears regulated value for butt welding

## 2 Mild steel and high-tensile steel arc welding material

Approvals	Steel type	Yield point (N/mm <sup>2</sup> )	Tensile strength (N/mm <sup>2</sup> )	EL (%)	Impact value		
					Grade	°C	J
KR	Mild steel	≥305	400-560	≥22	RMW1 RMW2 RMW3	20 0 -20	≥47(≥34)
	YP32,38 High tensile steel	≥375	490-660		RMW52 RMW53	0 -20	
	YP50 High tensile steel	≥490	570-730	≥20	RMW61 RMW62 RMW63	0 -20 -30	
ABS	Mild steel	≥305	400-655	≥22	1 2 3	20 0 -20 or -10	≥47(≥34) or ≥61
	YP32,38 High tensile steel	≥370	490-655		1Y 2Y 3Y	20 or 0 0 or -20 -20 or -40	≥54(≥34) or ≥27
LR	Mild steel	≥305	400-560		≥22	1 2 3	20 0 -20
	YP32,38 High tensile steel	≥375	460-660	1Y 2Y 3Y		20 0 -20	
BV	Mild steel	≥305	400-560	≥22		1 2 3	20 0 -20
	YP32,38 High tensile steel	≥375	490-660		1Y 2Y 3Y	20 0 -20	
DNV	Mild steel	≥305	400-560		≥22	I II III	20 0 -20
	YP32,38 High tensile steel	≥375	490-660	IY IIY IIY IVY VY		20 0 -20 -40 -60	
	YP40 High tensile steel	≥400	510-690	IIY40 IIY40 IVY40		0 -20 -40	≥47(≥41)
NK	Mild steel	≥305	400-560	≥22	KMW1 KMW2 KMW3	20 0 -20	≥47(≥34)
	YP32,38 High tensile steel	≥375	490-660		KMW52 KMW53 KMW54	0 -20 -40	
	YP40 High tensile steel	≥400	510-690		KMW52Y40 KMW53Y40 KMW54Y40	0 -20 -40	

Remark: ( ) value in impact value blank appears regulated value for butt vertical welding

# Standards of welding consumables

Classification Society

## 3 Mild steel and high-tensile sub merged arc welding material

Approvals	Steel type	Yield point (N/mm <sup>2</sup> )	Tensile strength (N/mm <sup>2</sup> )	EL (%)	Impact value		
					Grade	°C	J
KR	Mild steel	≥305	400-560	≥22	RMW1 RMW2 RMW3	20 0 -20	≥34
	YP32,38 High tensile steel	≥375	490-660	≥22	RMW52 RMW53	0 -20	
	YP50 High tensile steel	≥490	570-730	≥20	RMW61 RMW62 RMW63	0 -20 -30	
ABS	Mild steel	≥305	400-655	≥22	1 2 3	20 0 -20 or -10	≥34 or ≥27
	YP32,38 High tensile steel	≥370	490-655		1Y 2Y 3Y	20 or 0 0 or -20 -20 or -30	≥40 or ≥27
LR	Mild steel	≥305	400-560	≥22	1 2 3	20 0 -20	≥34
	YP32,38 High tensile steel	≥375	460-660		1Y 2Y 3Y		
BV	Mild steel	≥305	400-560	≥22	1 2 3	20 0 -20	≥34
	YP32,38 High tensile steel	≥375	490-660		1Y 2Y 3Y	20 0 -20	
DNV	Mild steel	≥305	400-560	≥22	I II III	20 0 -20	≥34
	YP32,38 High tensile steel	≥375	490-660		IY IIY IIYY IVY VY	20 0 -20 -40 -60	
	YP40 High tensile steel	≥400	510-690		IIY40 IIYY40 IVY40	0 -20 -40	
NK	Mild steel	≥305	400-560	≥22	KMW1 KMW2 KMW3	20 0 -20	≥34
	YP32,38 High tensile steel	≥375	490-660		KMW52 KMW53 KMW54	0 -20 -40	
	YP40 High tensile steel	≥400	510-690		KMW52Y40 KMW53Y40 KMW54Y40	0 -20 -40	

Remark: ( ) value in impact value blank appears regulated value for butt vertical welding



**4 Low Temperature Arc Electrode, Gas Shield Arc Welding Materials and Sub Merged Arc Welding Material**

Approvals	Steel type	Yield point (N/mm <sup>2</sup> )	Tensile strength (N/mm <sup>2</sup> )	EL (%)	Impact value			
					Grade	°C	J	
KR	Low temperature steel	≥305	400-560	≥22	RMWL1 RSWL1 RAWL1	-40	≥34 (≥27)	
		≥345	440-610		RMWL2 RSWL2 RAWL2	-60		
		≥375	490-660	≥21	RMWL3 RSWL3 RAWL3			-196
			≥590	≥25	RMWL91 RSWL91 RAWL91			
		≥410	≥660	≥25	RMWL92 RSWL92 RAWL92			
LR		≥375	≥460	≥22	1 1/2Ni	-80	≥34	
			≥420	≥25	3 1/2Ni	-100		
			≥500		5Ni	-120		
			≥600	9Ni	-196			
DNV		≥305	400-560	≥22	5/V	-55	≥41	
	≥375	490-660	5Y/VY			-60	≥34	
				-55	≥41			
	≥275	≥420	≥25	NV1.5Ni	-95	≥34		
		≥345		≥440	NV3.5Ni		-115	
		≥390		≥570	NV5Ni		-140	
≥490		≥640		NV9Ni	-196			
NK	≥305	400-560	≥22	KMWL1 KSWL1 KAWL1	-40	≥34 (≥27)		
	≥345	440-610		KMWL2 KSWL2 KAWL2	-60			
	≥375	490-660	≥21	KMWL3 KSWL3 KAWL3			-196	≥27
		≥590	≥25	RMWL91 RSWL91 RAWL91				
	≥410	≥660	≥25	RMWL92 RSWL92 RAWL92				

Remark: ( ) value in impact value blank appears RAWL(KAWL) case 1,2,3

SMW  
SAW  
GMAW  
GTAW  
FCAW  
Non-FERROUS  
APPENDIX

# Reference Material

## 1 Hardness conversion table

Vickers Hardness (DPH)	Brinell hardness 10mm Ball 3,000kg load		Rockwell Hardness		Shore Hardness	Tensile Strength (kgf/mm <sup>2</sup> ) (approx)
	Standard Ball	Tungsten Carbide Ball	B scale	C scale		
940	-	-	-	68.0	97	-
920	-	-	-	67.5	96	-
900	-	-	-	67.0	95	-
880	-	767	-	66.4	93	-
860	-	757	-	65.9	92	-
840	-	745	-	65.3	91	-
820	-	733	-	64.7	90	-
800	-	722	-	64.0	88	-
780	-	710	-	63.5	87	-
760	-	698	-	62.6	86	-
740	-	684	-	61.8	84	-
720	-	670	-	61.0	83	-
700	-	656	-	60.1	81	-
690	-	647	-	59.7	-	-
680	-	638	-	59.2	80	-
670	-	630	-	58.8	-	227
660	-	620	-	58.3	79	224
650	-	611	-	57.8	-	220
640	-	601	-	57.3	77	217
630	-	591	-	56.8	-	213
620	-	582	-	56.3	75	210
610	-	573	-	55.7	-	206
600	-	564	-	55.2	74	203
590	-	554	-	54.7	-	199
580	-	545	-	54.1	72	196
570	-	535	-	53.6	-	192
560	-	525	-	53.0	71	189
550	505	517	-	52.3	-	185
540	496	507	-	51.7	69	182
530	488	497	-	51.1	-	178
520	480	488	-	50.5	67	175
510	473	479	-	49.8	-	171
500	465	471	-	49.0	66	168
490	456	460	-	48.4	-	164
480	448	452	-	47.7	64	161
470	441	442	-	46.9	-	157
460	433	433	-	46.1	62	154
450	425	425	-	45.3	-	150
440	415	415	-	44.5	59	147
430	405	405	-	43.6	-	143
420	397	397	-	42.7	57	140

Vickers Hardness (DPH)	Brinell hardness 10mm Ball 3,000kg load		Rockwell Hardness		Shore Hardness	Tensile Strength (kgf/mm <sup>2</sup> ) (approx)
	Standard Ball	Tungsten Carbide Ball	B scale	C scale		
410	388	388	-	41.8	-	137
400	379	379	-	40.8	55	133
390	369	369	-	39.8	-	130
380	360	360	(110.0)	38.8	52	126
370	350	350	-	37.7	-	123
360	341	341	(109.0)	36.5	50	119
350	331	331	-	35.5	-	116
340	322	322	(108.0)	34.4	47	113
330	313	313	-	33.3	-	109
320	303	303	(107.0)	32.2	45	106
310	294	294	-	31.0	-	102
300	284	284	(105.5)	29.8	42	99
295	280	280	-	29.2	-	97.8
290	275	275	(104.5)	28.5	41	95.2
285	270	270	-	27.8	-	94.1
280	265	266	(103.5)	27.1	40	92.0
275	261	261	-	26.4	-	90.6
270	256	256	(102.0)	25.6	38	88.6
265	252	252	-	24.8	-	87.2
260	247	248	(101.2)	24.0	37	85.1
255	243	243	-	23.1	-	83.7
250	238	238	99.5	22.2	36	81.0
245	233	233	-	21.3	-	80.1
240	228	228	98.1	20.3	34	78.0
230	219	219	96.7	(18.0)	33	74.5
220	209	209	95.0	(15.7)	32	71.0
210	200	200	93.6	(13.4)	30	68.2
190	181	181	89.5	(8.5)	28	61.8
180	171	171	87.1	(6.0)	26	59.0
170	162	162	85.0	(0.3)	25	55.5
160	152	152	81.7	(0.0)	24	52.7
150	143	143	78.7	-	22	49.9
140	133	133	75.0	-	21	46.4
130	124	124	71.2	-	20	43.6
120	114	114	66.7	-	-	40.1
110	105	105	62.3	-	-	-
105	95	95	56.2	-	-	-
95	90	90	52.2	-	-	-
90	86	86	48.0	-	-	-
85	81	81	41.0	-	-	-

# Reference Material

## 2 Stress conversion table (1)

(lbs/in<sup>2</sup> → kgf/mm<sup>2</sup>)

lbs/in <sup>2</sup>	0.000	1.000	2.000	3.000	4.000	5.000	6.000	7.000	8.000	9.000
Kgf/mm <sup>2</sup>	Kgf/mm <sup>2</sup>	Kgf/mm <sup>2</sup>	Kgf/mm <sup>2</sup>	Kgf/mm <sup>2</sup>	Kgf/mm <sup>2</sup>	Kgf/mm <sup>2</sup>	Kgf/mm <sup>2</sup>	Kgf/mm <sup>2</sup>	Kgf/mm <sup>2</sup>	Kgf/mm <sup>2</sup>
0.000	0.000	0.703	1.406	2.109	2.812	3.515	4.218	4.922	5.625	6.328
10,000	7.031	7.734	8.437	9.140	9.843	10.546	11.249	11.952	12.655	13.359
20,000	14.063	14.765	15.468	16.171	16.874	17.577	18.280	18.983	19.686	20.398
30,000	21.092	21.796	22.499	23.202	23.905	24.608	25.311	26.014	26.717	27.420
40,000	28.123	28.826	29.529	30.233	30.936	31.639	32.342	33.045	33.748	34.451
50,000	35.154	35.857	36.560	37.263	37.966	38.669	39.373	40.076	40.779	41.482
60,000	42.185	42.888	43.591	44.294	44.997	45.700	46.403	47.106	47.810	48.513
70,000	49.216	49.919	50.622	51.325	52.028	52.731	53.434	54.137	54.840	55.543
80,000	56.247	56.950	57.653	58.356	59.059	59.762	60.465	61.168	61.871	62.574
90,000	63.277	63.980	64.683	65.387	66.090	66.793	67.496	68.199	68.902	69.605
100,000	70.308	71.011	71.714	72.417	73.120	73.824	74.527	75.230	75.933	76.635
110,000	77.339	78.042	78.745	79.448	80.151	80.854	81.557	82.261	82.964	83.667
120,000	84.370	85.073	85.776	86.479	87.182	87.885	88.588	89.291	89.994	90.698
130,000	91.401	92.104	92.807	93.510	94.213	94.916	95.619	96.322	97.025	97.728
140,000	98.431	99.134	99.838	100.541	101.244	101.947	102.650	103.353	104.056	104.759
150,000	105.462	106.165	106.868	107.571	108.275	108.978	109.681	110.384	111.087	111.790
160,000	112.493	113.196	113.899	114.502	115.205	115.908	116.612	117.315	118.018	118.721
170,000	119.524	120.227	120.930	121.633	122.336	123.039	123.742	124.445	125.148	125.852
180,000	123.555	127.258	127.961	128.664	129.367	130.070	130.773	131.476	132.179	132.882
190,000	133.585	134.289	134.992	135.695	136.398	137.101	137.804	138.507	13.210	139.913
200,000	140.161	141.319	142.022	142.726	143.429	144.132	144.835	145.538	146.241	146.944
210,000	147.647	148.350	149.058	149.756	150.459	151.166	151.866	152.569	153.272	153.975
220,000	154.678	155.381	156.084	156.787	157.490	158.193	158.896	159.599	160.303	161.006
230,000	161.709	162.412	163.115	163.818	164.521	165.224	165.927	166.630	167.333	168.036
240,000	168.740	169.443	170.146	170.849	171.552	172.255	172.958	173.661	174.364	175.067
250,000	175.770	176.473	177.177	177.880	178.583	179.286	179.989	180.692	181.395	182.098

lbs/in <sup>2</sup>	100	200	300	400	500	600	700	800	900
Kgf/mm <sup>2</sup>	0.0703	0.1406	0.2109	0.2812	0.3512	0.4218	0.4918	0.5625	0.6328

### 3 Stress conversion table (2)

(kgf/mm<sup>2</sup> → MPa) / Conversion Factor: 1kgf/mm<sup>2</sup> = 9.80665MPa

Kgf/mm <sup>2</sup>	MPa										Kgf/mm <sup>2</sup>
	0	0.1	0.2	0.3	0.4	0.5	0.6	0.7	0.8	0.9	
-		0.9807	1.9613	2.9420	3.9227	4.9033	5.8840	6.8647	7.8453	8.826	-
1	9.8067	10.787	11.768	12.749	13.729	14.710	15.691	16.671	17.652	18.633	1
2	19.613	20.594	21.575	22.555	23.536	24.517	25.497	26.478	27.459	28.439	2
3	29.420	30.401	31.381	32.362	33.343	34.323	35.304	36.285	37.265	38.246	3
4	39.227	40.207	41.188	42.169	43.149	44.130	45.111	46.091	47.072	48.053	4
5	49.033	50.014	50.995	51.975	52.956	53.937	54.917	55.898	56.879	57.859	5
6	58.840	59.821	60.801	61.763	62.763	63.743	64.724	65.705	66.685	67.666	6
7	68.647	69.627	70.608	71.589	72.569	73.550	74.531	75.511	76.492	77.473	7
8	78.453	79.434	80.415	81.395	82.376	83.357	84.337	85.318	86.299	87.279	8
9	88.260	89.241	90.221	91.202	92.138	93.163	94.144	95.125	96.105	97.086	9
10	98.067	99.047	100.03	101.01	101.99	102.97	103.95	104.63	105.91	106.89	10
11	107.87	108.85	109.83	110.82	111.80	112.78	113.76	114.74	115.72	116.70	11
12	117.68	118.66	119.64	120.62	121.60	122.58	123.56	124.54	125.53	126.51	12
13	127.49	128.47	129.45	130.43	131.41	132.39	133.37	134.35	135.33	136.31	13
14	137.29	138.27	139.25	140.24	141.22	142.20	143.18	144.16	145.14	146.12	14
15	147.10	148.08	149.06	150.04	151.02	152.00	152.98	135.96	154.95	155.93	15
16	156.91	157.89	158.87	159.85	160.83	161.81	162.79	163.77	164.75	165.73	16
17	166.71	167.69	168.67	169.66	170.64	171.62	172.60	173.58	174.56	175.54	17
18	176.52	177.50	178.48	179.46	180.44	181.42	182.40	183.38	184.37	185.35	18
19	186.33	187.31	188.29	189.27	190.25	191.23	192.21	193.19	194.17	195.15	19
20	196.13	197.11	198.09	199.07	200.06	201.04	202.02	203.00	203.98	204.96	20
21	205.94	206.92	207.90	208.88	209.86	210.84	211.82	212.80	213.78	214.77	21
22	215.75	216.73	217.71	218.69	219.67	220.65	221.63	222.61	223.59	224.57	22
23	225.55	226.53	227.51	228.49	229.48	230.46	231.44	232.42	233.40	234.37	23
24	235.36	236.34	237.32	238.30	239.28	240.26	241.24	242.22	243.20	244.19	24
25	245.17	246.15	247.13	248.11	249.09	250.07	251.05	252.03	253.01	253.99	25
26	254.97	255.95	256.93	257.91	258.90	259.88	260.86	261.84	262.82	263.80	26
27	264.78	265.76	266.74	267.72	268.70	269.68	270.66	271.64	272.62	273.61	27
28	274.59	275.57	276.55	277.53	278.51	279.49	280.47	281.45	282.43	283.41	28
29	284.39	285.37	286.35	287.33	288.32	289.30	290.28	291.26	292.24	293.22	29
30	294.20	295.18	296.16	297.14	298.12	299.10	300.08	301.06	302.04	303.03	30
31	304.01	304.99	305.97	306.95	307.93	308.91	309.89	310.87	311.85	312.83	31
32	313.81	314.79	315.77	316.75	317.74	318.72	319.70	320.68	321.66	322.64	32
33	323.62	324.60	325.58	326.56	327.54	328.52	329.50	330.48	331.46	332.45	33
34	333.63	334.41	335.39	336.37	337.35	338.33	339.31	340.29	341.27	342.25	34
35	343.23	344.21	345.19	346.17	347.16	348.14	349.12	350.10	351.08	352.06	35
36	353.04	354.02	355.00	355.98	356.96	357.94	358.92	359.90	360.88	361.87	36
37	362.85	363.83	364.81	365.79	366.77	367.75	368.73	369.71	370.69	370.67	37
38	372.65	373.63	374.61	375.59	376.58	377.56	378.54	379.52	380.50	381.48	38
39	382.46	383.44	384.42	385.40	386.38	387.36	388.34	389.32	390.30	391.29	39
40	392.27	393.25	394.23	395.21	396.19	397.17	398.15	399.13	400.11	401.09	40
41	402.07	403.05	404.03	405.01	406.00	406.98	407.96	408.94	409.92	410.90	41
42	411.88	412.86	413.84	414.82	415.80	416.78	417.76	418.74	419.72	420.71	42
43	421.69	422.67	423.65	424.63	425.61	426.59	427.57	428.55	429.53	430.51	43
44	431.49	432.47	433.45	434.43	435.42	436.40	437.38	438.35	439.34	440.32	44
45	441.30	442.28	443.26	444.24	445.22	446.20	447.18	448.16	449.14	450.13	45
46	451.11	452.09	453.07	454.05	455.03	456.01	456.99	457.97	458.95	459.93	46
47	460.91	461.89	462.87	463.85	464.84	465.82	466.80	467.79	468.76	469.74	47
48	470.72	471.70	472.68	473.66	474.64	475.62	476.60	477.58	478.56	479.55	48
49	480.53	481.51	482.49	483.47	484.45	485.43	486.41	487.39	488.37	489.35	49

SMW  
SAW  
GMW  
GTAW  
FCW  
Non-FERROUS  
APPENDIX

# Reference Material

(kgf/mm<sup>2</sup> → MPa) / Conversion Factor: 1kgf/mm<sup>2</sup> = 9.80665MPa

Kgf/mm <sup>2</sup>	MPa										Kgf/mm <sup>2</sup>
	0	0.1	0.2	0.3	0.4	0.5	0.6	0.7	0.8	0.9	
50	490.33	491.31	492.29	493.27	494.26	495.24	496.22	497.20	498.18	499.16	50
51	500.14	501.12	502.10	503.08	504.06	505.04	506.02	507.00	507.98	508.97	51
52	509.95	510.93	511.91	512.89	513.85	514.85	515.83	516.81	517.79	518.77	52
53	519.75	520.73	521.71	522.69	523.68	524.66	525.64	526.62	527.60	528.58	53
54	529.56	530.54	531.52	532.50	533.48	534.46	535.44	536.42	537.40	538.39	54
55	539.37	540.35	541.33	542.31	543.29	544.27	545.25	546.23	547.21	548.19	55
56	549.17	550.15	551.13	552.11	553.10	554.08	555.06	556.04	557.02	558.00	56
57	558.98	559.96	560.94	561.92	562.90	563.88	564.83	565.84	566.82	567.81	57
58	568.79	569.77	570.75	571.73	572.71	573.69	574.67	575.65	576.63	577.61	58
59	578.59	579.57	580.55	581.53	582.52	583.50	584.48	585.46	586.44	587.42	59
60	588.40	589.38	590.35	591.34	592.32	593.30	594.28	595.26	596.24	597.22	60
61	598.21	599.19	600.17	601.15	602.13	603.11	604.06	605.07	606.56	607.06	61
62	608.01	608.99	609.67	610.95	611.93	612.92	613.90	614.88	615.56	616.84	62
63	617.82	618.80	619.78	620.76	621.74	622.72	623.70	624.68	625.66	626.64	63
64	627.63	628.61	629.59	630.57	631.55	632.53	633.51	634.49	635.47	636.45	64
65	637.43	638.41	639.39	640.37	641.35	642.34	643.32	644.30	645.28	646.26	65
66	647.24	648.22	649.20	650.18	651.16	652.14	653.12	654.10	655.08	656.06	66
67	657.05	658.03	659.01	659.99	660.97	661.95	662.93	663.91	664.89	665.87	67
68	666.85	667.83	668.81	669.79	670.77	671.76	672.74	673.72	674.70	675.68	68
69	676.66	677.64	678.62	679.60	680.58	681.56	682.54	683.52	684.50	685.48	69
70	686.47	687.45	688.43	689.41	690.39	691.37	692.16	693.33	694.31	695.29	70
71	696.27	697.25	698.23	699.21	700.19	701.18	702.16	703.14	704.12	705.10	71
72	706.08	707.06	708.04	709.025	710.00	710.98	711.96	712.94	713.92	714.90	72
73	715.89	716.87	717.85	718.83	719.81	720.79	721.77	722.75	723.73	724.71	73
74	725.69	726.67	727.65	728.63	729.61	730.60	731.58	732.56	733.73	734.52	74
75	735.50	736.48	737.46	738.44	739.42	740.40	741.38	742.36	743.34	744.32	75
76	745.31	746.29	747.27	748.25	749.23	750.21	751.19	752.17	753.15	754.13	76
77	755.11	756.09	757.07	758.05	759.03	760.02	761.00	761.98	762.96	763.94	77
78	764.92	765.90	766.88	767.86	768.84	769.82	770.80	771.78	772.76	773.74	78
79	774.73	775.71	776.69	777.67	778.65	779.63	780.61	781.59	782.57	783.55	79
80	784.53	785.51	786.49	787.47	788.26	789.44	790.42	791.40	792.38	793.36	80
81	794.34	795.32	796.30	797.27	798.26	799.24	800.22	801.20	802.18	803.16	81
82	804.15	805.13	806.11	807.09	808.07	809.05	810.03	811.01	811.99	812.97	82
83	813.95	814.93	815.91	816.89	817.87	818.86	819.84	820.82	821.80	822.78	83
84	823.76	824.74	825.72	826.70	827.68	828.66	829.64	830.62	831.60	832.75	84
85	833.57	834.55	835.53	836.51	837.49	838.47	839.45	840.43	841.41	842.39	85
86	843.37	844.35	845.33	846.31	847.29	848.28	849.26	850.24	851.22	852.20	86
87	853.18	854.16	855.14	856.12	857.10	858.08	859.06	860.04	861.02	862.00	87
88	862.99	863.97	864.95	865.93	866.91	867.89	868.87	869.85	870.83	871.81	88
89	872.79	873.77	874.75	875.73	876.71	877.70	878.48	879.66	880.64	881.62	89
90	882.41	883.58	884.56	885.54	886.52	887.50	888.48	889.49	890.44	891.42	90
91	892.41	893.93	894.37	895.35	896.33	897.31	898.29	899.27	900.25	901.23	91
92	902.21	903.19	904.17	905.15	906.13	907.12	908.10	909.08	910.06	911.04	92
93	912.02	913.00	913.98	914.96	915.94	916.92	917.90	918.88	919.86	920.84	93
94	921.83	922.81	923.79	924.77	925.75	926.13	927.71	928.69	929.67	930.65	94
95	931.63	932.61	933.59	934.57	935.55	936.54	937.52	938.50	939.48	940.46	95
96	941.44	942.42	943.40	944.38	945.36	946.34	947.32	948.30	949.28	950.26	96
97	951.25	952.23	953.22	954.19	955.17	956.15	957.13	958.11	959.09	960.07	97
98	891.05	962.03	963.01	963.99	964.97	965.96	966.94	967.92	968.90	969.88	98
99	970.86	971.84	972.82	973.80	974.78	975.76	976.74	977.72	978.70	979.68	99

#### 4 Stress conversion table (3)

(MPa → kgf/mm<sup>2</sup>) / Conversion Factor: 1MPa = 0.10197kgf/mm<sup>2</sup>

MPa	Kgf/mm <sup>2</sup>									MPa	
	0	0.1	0.2	0.3	0.4	0.5	0.6	0.7	0.8		0.9
-	-	0.1020	0.2039	0.3059	0.4079	0.5099	0.6118	0.7138	0.8158	0.9177	
10	1.0197	1.1217	1.12237	1.3256	1.3276	1.5296	1.6315	1.7335	1.8355	1.9375	10
20	2.0394	2.1417	2.2434	2.3453	2.4473	2.5493	2.6543	2.7532	2.8552	2.9572	20
30	3.0591	3.1611	3.2631	3.3651	3.4670	3.5690	3.6710	3.7729	3.8749	3.9769	30
40	4.0789	4.1808	4.2828	4.3848	4.4868	4.5887	4.6907	4.7927	4.8946	4.9966	40
50	5.0936	5.2006	5.3025	5.4045	5.5065	5.6084	5.7104	5.8124	5.9144	6.0163	50
60	6.1183	6.2203	6.3222	6.4242	6.5262	6.6282	6.7301	6.8321	6.9341	7.0363	60
70	7.1380	7.2400	7.3420	7.4439	7.5499	7.6479	7.7498	7.8518	7.9538	8.0558	70
80	8.1577	8.2597	8.3617	8.4636	8.5656	8.6676	8.7696	8.8715	8.9735	9.0755	80
90	9.1774	9.2794	9.3814	9.4834	9.5853	9.6873	9.7893	9.8912	9.9932	10.095	90
100	10.197	10.290	10.401	10.503	10.605	10.707	10.809	10.911	11.013	11.115	100
110	11.217	11.319	11.421	11.523	11.625	11.727	11.829	11.931	12.033	12.135	110
120	12.237	12.339	12.441	12.543	12.644	12.764	12.848	12.950	13.052	13.154	120
130	13.256	13.358	13.460	13.562	13.644	13.766	13.868	13.970	14.072	14.174	130
140	14.276	14.378	14.480	14.582	14.674	14.786	14.888	14.990	15.092	15.194	140
150	15.296	15.398	15.500	15.602	15.704	15.806	15.908	16.010	16.112	16.213	150
160	16.315	16.417	16.519	16.621	16.723	16.825	16.927	17.029	17.131	17.233	160
170	17.335	17.437	17.539	17.641	17.743	17.845	17.947	18.049	18.151	18.253	170
180	18.355	18.457	18.559	18.661	18.763	18.865	18.967	19.069	19.171	19.273	180
190	19.375	19.477	19.579	19.681	19.782	19.884	19.986	20.088	20.190	20.292	190
200	20.394	20.496	20.598	20.700	20.802	20.904	21.006	21.108	21.210	21.312	200
210	21.414	21.516	21.618	21.720	21.822	21.924	22.026	22.128	22.230	22.332	210
220	22.434	22.536	22.638	22.740	22.842	22.944	23.046	23.148	23.250	23.352	220
230	23.453	23.555	23.657	23.759	23.861	23.963	24.065	24.167	24.269	24.371	230
240	24.473	24.575	24.677	24.779	24.881	24.983	25.085	25.187	25.289	25.391	240
250	25.493	25.595	25.697	25.799	25.901	26.003	26.015	26.207	26.309	26.411	250
260	26.513	26.614	26.717	26.899	26.921	27.022	27.124	27.223	27.328	27.430	260
270	27.532	27.634	27.736	27.838	27.940	27.042	28.144	28.246	28.348	28.450	270
280	28.552	28.654	28.756	28.858	28.960	29.062	29.164	29.266	29.368	29.470	280
290	29.572	29.674	29.776	29.878	29.980	30.082	30.184	30.286	30.388	30.490	290
300	30.591	30.693	30.795	30.897	30.999	31.101	31.203	31.305	31.407	31.509	300
310	31.611	31.713	31.815	31.917	32.019	32.121	32.223	32.325	32.427	32.529	310
320	32.631	32.733	32.835	32.937	33.039	33.141	33.243	33.345	33.447	33.549	320
330	33.651	33.753	33.855	33.957	34.059	34.160	34.262	34.364	34.466	34.568	330
340	34.670	34.772	34.874	34.976	35.078	35.180	35.282	35.384	35.486	35.588	340
350	35.690	35.792	35.894	35.996	36.098	36.200	36.302	36.404	36.506	36.608	350
360	36.710	36.812	36.914	37.016	37.118	37.220	37.322	37.424	37.526	37.628	360
370	37.729	37.831	37.933	38.035	38.137	38.239	38.341	38.443	38.545	38.647	370
380	38.749	38.851	38.953	39.055	39.157	39.259	39.361	39.463	39.565	39.667	380
390	39.769	39.871	39.973	40.075	40.177	40.279	40.381	40.483	40.585	40.687	390
400	40.789	40.891	40.993	41.095	41.197	41.299	41.400	41.502	41.604	41.706	400
410	41.808	41.910	42.012	42.114	42.216	42.318	42.420	42.522	42.624	42.726	410
420	42.848	42.930	43.032	43.134	43.236	43.338	43.440	43.542	43.644	43.746	420
430	43.848	44.950	44.052	44.154	44.256	44.358	44.460	44.562	44.664	44.766	430
440	44.868	44.969	45.071	45.173	45.275	45.377	45.479	45.581	45.683	45.785	440
450	45.88	45.989	46.091	46.193	46.295	46.397	46.499	46.601	46.703	46.805	450
460	46.907	47.009	47.111	47.213	47.315	47.417	47.519	47.621	47.723	47.825	460
470	47.927	48.029	48.131	48.233	48.335	48.437	48.538	48.640	48.742	48.844	470
480	48.946	49.048	49.150	49.253	49.354	49.456	49.558	49.660	49.762	49.864	480
490	49.966	50.068	50.170	50.272	50.374	50.476	50.578	50.680	50.782	50.884	490

SMAW  
 SAW  
 GMAW  
 GTAW  
 FCAW  
 Non-FERROUS  
 APPENDIX

# Reference Material

(MPa → kgf/mm<sup>2</sup>) / Conversion Factor: 1MPa = 0.10197kgf/mm<sup>2</sup>

MPa	Kgf/mm <sup>2</sup>										MPa
	0	0.1	0.2	0.3	0.4	0.5	0.6	0.7	0.8	0.9	
500	50.986	51.088	51.190	51.292	51.394	51.496	51.598	51.700	51.802	51.904	500
510	52.006	52.107	52.209	52.311	52.413	52.515	52.617	52.719	52.821	52.923	510
520	53.025	53.127	53.229	53.33	53.433	53.535	53.637	53.739	53.841	53.943	520
530	54.025	54.147	54.249	54.351	54.453	54.555	54.657	54.759	54.861	54.963	530
540	55.265	55.167	55.269	55.371	55.473	55.575	55.677	55.779	55.880	55.982	540
550	56.084	56.186	56.288	56.390	56.492	56.594	56.696	56.798	56.900	57.002	550
560	57.104	57.206	57.308	57.410	57.512	57.614	57.716	57.818	57.920	58.022	560
570	58.124	58.226	58.328	58.430	58.532	58.634	58.736	58.838	58.940	59.042	570
580	59.144	59.246	59.347	59.449	59.551	59.653	59.755	59.857	59.959	60.061	580
590	60.163	60.265	60.367	60.469	60.571	60.673	60.775	60.877	60.979	61.081	590
600	61.183	61.285	61.387	61.489	61.591	61.693	61.795	61.897	61.999	62.101	600
610	62.203	62.305	62.407	62.509	62.611	62.713	62.815	62.917	63.018	63.120	610
620	63.222	63.324	63.426	63.528	63.630	63.732	63.834	63.936	64.038	64.140	620
630	64.242	64.344	64.446	64.548	64.650	64.752	64.854	64.956	65.058	65.160	630
640	65.262	65.364	65.466	65.568	65.670	65.772	65.874	65.976	66.078	66.180	640
650	66.282	66.384	66.486	66.588	66.689	66.791	66.893	66.995	67.097	67.199	650
660	67.301	67.403	67.404	67.607	67.709	67.811	67.913	68.15	68.117	68.219	660
670	68.321	68.432	68.525	68.627	68.729	68.831	68.933	69.035	69.137	69.239	670
680	69.341	69.443	69.545	69.647	69.749	69.851	69.953	70.055	70.156	70.258	680
690	70.360	70.462	70.564	70.666	70.768	70.870	70.972	71.074	71.176	71.278	690
700	71.380	71.482	71.584	71.686	71.788	71.890	71.992	72.094	72.196	72.298	700
710	72.400	72.402	72.604	72.706	72.808	72.910	73.012	73.114	73.216	73.318	710
720	73.420	73.522	73.624	73.725	73.827	73.929	74.031	74.133	74.295	74.337	720
730	74.439	74.541	74.643	74.745	74.847	74.949	75.051	75.153	75.255	75.357	730
740	75.459	75.561	75.663	75.765	75.867	75.969	76.071	76.173	76.275	76.377	740
750	76.479	76.581	76.682	76.785	76.887	76.989	77.081	77.193	77.294	77.396	750
760	77.498	77.600	77.702	77.804	77.906	78.008	78.110	78.212	78.314	78.416	760
770	78.518	78.620	78.722	78.824	78.926	79.028	79.130	79.232	79.334	79.436	770
780	79.538	79.640	79.742	79.844	79.946	80.048	80.150	80.252	80.354	80.456	780
790	80.558	80.660	80.762	80.863	80.965	81.067	81.169	81.271	81.373	81.475	790
800	81.577	81.679	81.762	81.833	81.985	82.087	82.189	82.291	82.393	82.495	800
810	82.597	82.699	82.801	82.903	83.005	83.107	83.209	83.311	83.413	83.515	810
820	83.617	83.719	83.821	83.923	84.025	84.127	84.229	84.331	84.433	84.534	820
830	84.636	84.738	84.840	84.942	85.044	85.146	85.248	85.350	85.452	85.554	830
840	85.656	85.758	85.860	85.962	86.064	86.166	86.268	86.370	86.472	86.574	840
850	86.676	86.778	86.880	86.982	87.084	87.186	87.288	87.390	87.492	87.594	850
860	87.696	87.798	87.900	88.002	88.103	88.205	88.307	88.409	88.511	88.613	860
870	88.715	88.817	88.919	89.021	89.123	89.225	89.327	89.429	89.531	89.633	870
880	89.735	89.837	89.939	90.041	90.143	90.245	90.347	90.449	90.551	90.653	880
890	90.755	90.857	90.959	91.061	91.163	91.265	91.367	91.469	91.571	91.672	890
900	91.774	91.876	91.978	92.080	92.182	92.284	92.386	92.488	92.590	92.692	900
910	92.794	92.896	92.998	93.100	93.202	93.304	93.406	93.508	93.610	93.712	910
920	93.814	93.916	93.100	94.120	94.222	94.324	94.426	94.528	94.630	94.732	920
930	94.834	94.936	94.140	95.140	95.241	95.343	95.445	95.547	95.649	95.751	930
940	95.853	95.955	96.159	96.159	96.261	96.363	96.465	96.567	96.669	96.771	940
950	96.873	96.975	97.179	97.179	97.281	97.383	97.485	97.589	97.689	97.791	950
960	97.893	97.995	98.301	98.199	98.301	98.403	98.505	98.607	98.709	98.811	960
970	98.912	99.014	99.218	99.218	99.320	99.422	99.524	99.626	99.728	99.830	970
980	99.932	100.03	100.24	100.24	100.34	100.44	100.52	100.67	100.75	100.85	980
990	100.95	101.05	101.16	101.26	101.36	101.46	101.56	101.64	101.77	101.87	990



## 5 Impact value conversion table (1)

(ft.-lbs → kgf-m) / Conversion Factor: 1ft.-lbs = 0.138255kgf-m

ft.-lbs	0	1	2	3	4	5	6	7	8	9	ft.-lbs
	Kgm	Kgm	Kgm	Kgm	Kgm	Kgm	Kgm	Kgm	Kgm	Kgm	Kgm
0	0.000	0.138	0.276	0.415	0.553	0.691	0.830	0.968	1.106	1.244	0
10	1.383	1.521	1.659	1.797	1.936	2.074	2.212	2.350	2.489	2.627	10
20	2.765	2.903	3.042	3.180	3.318	3.456	3.595	3.733	3.871	4.009	20
30	4.148	4.286	4.424	4.562	4.701	4.839	4.977	5.116	5.254	5.392	30
40	5.530	5.667	5.807	5.945	6.083	6.222	6.360	6.498	6.636	6.774	40
50	6.913	7.051	7.189	7.328	7.466	7.604	7.742	7.881	8.019	8.157	50
60	8.295	8.434	8.572	8.710	8.848	8.987	9.125	9.263	9.401	9.540	60
70	9.678	9.816	9.955	10.093	10.231	10.369	10.508	10.646	10.784	10.922	70
80	11.061	11.199	11.337	11.475	11.614	11.752	11.890	12.028	12.167	12.305	80
90	12.443	12.581	12.720	12.858	12.996	13.134	13.273	13.411	13.549	13.687	90
100	13.826	13.964	14.105	14.240	14.379	14.517	14.655	14.794	14.932	15.070	100
110	15.208	15.347	15.482	15.623	15.761	15.900	16.038	16.176	16.314	16.453	110
120	16.591	16.729	16.867	17.006	17.144	17.282	17.420	17.559	17.697	17.835	120

SMAW

SAW

GMAW

GTAW

FCAW

Non-FERROUS

APPENDIX

# Reference Material

## 6 Impact value conversion table (2)

(kgf-m → N·m or J) / Conversion Factor: 1kgf-m = 9.80665N·m(or J)

kgf-m	N·m(or Joule)									
	0	0.1	0.2	0.3	0.4	0.5	0.6	0.7	0.8	0.9
	-	0.9807	1.9613	2.9420	3.9227	4.9033	5.8840	6.8647	7.8453	8.8260
1	9.8066	10.787	11.768	12.749	13.729	14.710	15.691	16.671	17.652	18.633
2	19.613	20.594	21.575	22.555	23.534	24.517	25.497	26.478	27.652	28.439
3	29.420	30.401	31.381	32.362	33.343	34.323	35.304	36.285	37.265	38.246
4	39.229	40.207	41.188	42.169	43.149	44.130	45.111	46.091	47.072	48.053
5	49.033	50.014	50.995	51.975	52.956	53.937	54.917	55.898	56.879	57.859
6	58.844	59.821	60.801	61.728	62.763	63.743	64.724	65.705	66.685	67.666
7	68.647	69.627	70.608	71.589	72.569	73.550	74.531	75.511	76.492	77.473
8	78.453	78.434	80.415	81.395	82.376	83.357	84.337	85.318	86.299	87.279
9	88.260	89.241	90.221	91.202	92.183	93.163	94.144	95.125	96.105	97.086
10	98.066	99.047	100.03	101.01	101.99	102.97	103.95	104.93	105.91	106.89
11	107.87	108.85	109.83	110.82	111.80	112.78	113.76	114.74	115.72	116.70
12	117.68	118.66	119.64	120.62	121.60	122.58	123.56	124.54	125.53	126.51
13	127.49	128.47	129.45	130.43	131.41	132.39	133.37	134.35	135.33	136.31
14	137.29	138.27	139.25	140.24	141.22	142.20	143.18	144.16	145.14	146.12
15	147.10	148.08	149.06	150.04	151.02	152.00	152.98	153.96	154.95	155.93
16	156.91	157.89	158.87	159.85	160.83	161.81	162.72	163.77	164.75	165.73
17	166.71	167.69	168.67	169.66	170.64	171.62	172.60	173.58	174.56	175.54
18	176.52	177.50	178.48	179.46	180.44	181.42	182.40	183.38	184.37	185.35
19	186.33	187.31	188.29	189.27	190.25	191.23	192.21	193.19	194.17	195.15
20	196.13	197.11	198.09	199.07	200.06	201.04	202.02	203.00	203.98	204.96
21	205.94	206.92	207.90	208.88	209.86	210.84	211.82	212.80	213.78	214.77
22	215.75	216.73	217.71	218.69	219.67	220.65	221.63	222.61	223.59	224.57
23	225.55	226.53	227.51	228.49	229.48	230.46	231.44	232.42	233.40	234.38
24	235.36	236.34	237.32	238.30	239.28	240.26	241.24	242.22	243.20	244.19
25	245.17	246.15	247.13	248.11	249.09	250.07	251.05	252.03	253.01	253.99
26	254.97	255.95	256.93	257.91	258.89	259.87	260.85	261.83	262.81	263.80
27	264.78	265.76	266.74	267.72	268.70	269.68	270.66	271.64	272.62	273.61
28	274.59	275.57	276.55	277.53	278.51	279.49	280.47	281.45	282.43	283.41
29	284.39	285.37	286.35	287.33	288.32	289.30	290.28	291.26	292.24	293.22
30	294.20	295.18	296.16	297.14	298.12	299.10	300.08	301.06	302.04	303.03
31	304.01	304.99	305.97	306.95	307.93	308.91	309.89	310.87	311.85	312.83
32	313.81	314.79	315.77	316.75	317.74	318.72	319.70	320.68	321.66	322.64
33	323.62	324.60	325.58	326.56	327.54	328.52	329.50	330.48	331.46	332.45
34	333.43	334.41	335.39	336.37	337.35	338.33	339.31	340.29	341.27	342.25
35	343.23	344.21	345.19	346.17	347.16	348.14	349.12	350.10	350.88	351.87
36	353.04	354.02	355.00	355.98	356.96	357.94	358.92	359.90	360.88	361.87
37	362.85	363.83	364.81	365.79	366.77	367.75	368.73	369.71	370.69	371.67
38	372.35	373.63	374.61	375.59	376.58	377.56	378.54	379.52	380.50	381.48
39	382.46	383.44	384.42	385.40	386.38	387.36	388.34	389.32	390.30	391.29
40	392.27	393.25	394.23	395.21	396.19	397.17	398.15	399.13	400.11	401.09
41	402.07	403.05	404.03	405.01	406.00	406.98	407.96	408.94	409.92	410.90
42	411.88	412.86	413.84	414.82	415.80	416.78	417.76	418.74	419.72	420.71
43	421.69	422.67	423.65	424.63	425.61	426.59	427.57	428.55	429.53	430.51
44	431.49	432.47	433.45	434.43	435.42	436.40	437.38	438.36	439.34	440.32
45	441.30	442.28	443.26	444.24	445.22	446.20	447.18	448.13	449.14	450.13
46	451.11	452.09	453.07	454.05	455.03	456.01	456.99	457.97	458.95	459.93
47	460.91	461.89	462.87	463.85	464.83	465.82	466.80	467.78	468.76	469.74
48	470.72	471.70	472.68	473.66	474.64	475.62	476.60	477.58	478.56	479.55
49	480.53	481.51	482.49	483.47	484.45	485.43	486.41	487.39	488.37	489.35

## (kgf-m → N-m or J) / Conversion Factor: 1kgf-m = 9.80665N-m(or J)

kgf-m	N-m(or Joule)									
	0	0.1	0.2	0.3	0.4	0.5	0.6	0.7	0.8	0.9
50	490.33	491.31	492.29	493.27	494.26	495.24	496.22	497.20	498.18	499.16
51	500.14	501.12	502.10	503.27	504.06	505.04	506.02	507.99	507.98	508.97
52	509.95	510.93	511.91	512.89	513.87	514.85	515.83	516.82	517.79	518.77
53	519.75	520.73	521.71	522.69	523.68	524.66	525.64	526.32	527.64	528.58
54	529.56	530.54	531.52	532.50	533.48	534.46	535.44	536.45	537.64	538.39
55	539.37	540.35	541.33	542.31	543.48	544.46	545.44	546.42	547.64	548.39
56	549.17	550.15	551.13	552.11	553.10	554.27	555.03	556.06	557.02	558.00
57	558.98	559.96	560.94	561.92	562.90	563.88	564.86	565.84	566.82	567.81
58	568.79	569.77	570.75	571.73	572.71	573.69	574.67	575.65	576.63	577.61
59	578.59	579.57	580.55	581.53	582.52	583.50	584.48	585.46	586.44	587.42
60	588.40	589.38	590.36	591.34	592.32	593.30	594.28	595.26	596.24	597.22
61	598.21	599.19	600.17	601.15	602.13	603.11	604.09	605.07	606.05	607.03
62	608.01	608.99	609.97	610.95	611.93	612.92	613.90	614.88	615.86	616.84
63	617.81	618.80	619.78	620.76	621.74	622.72	623.70	624.68	625.66	626.64
64	627.63	628.61	629.59	630.57	631.55	632.53	633.51	634.49	635.47	636.45
65	637.43	638.41	639.39	640.37	641.35	642.34	643.32	644.30	645.28	646.26
66	647.24	648.22	649.20	650.18	651.16	652.14	653.12	654.10	655.08	656.06
67	657.05	658.03	659.01	659.99	660.97	661.95	662.93	663.91	664.89	665.87
68	666.85	667.83	668.81	669.99	670.77	671.76	672.74	673.72	674.70	675.68
69	676.66	677.64	678.62	679.60	680.58	681.56	682.54	683.52	684.50	685.48
70	686.47	687.45	688.43	689.41	690.39	691.37	692.35	693.33	694.31	695.29
71	696.27	697.25	698.23	699.21	700.19	701.18	702.16	703.14	704.12	705.10
72	706.08	707.06	708.04	709.02	710.00	710.98	711.96	712.94	713.92	714.90
73	715.89	716.87	717.85	718.83	719.81	720.79	721.77	722.75	723.73	724.71
74	725.69	726.67	727.65	728.63	729.61	730.60	731.58	732.56	733.54	734.52
75	735.50	736.48	737.46	738.44	739.42	740.40	741.38	742.36	743.34	744.32
76	745.31	746.29	747.27	748.25	749.23	750.21	751.19	752.17	753.15	754.13
77	755.11	756.09	757.07	758.05	759.03	760.02	761.00	761.98	762.96	763.94
78	764.92	765.90	766.88	767.86	768.84	769.82	770.80	771.78	772.76	773.74
78	774.73	775.71	776.69	777.67	778.65	779.63	780.61	781.59	782.57	783.55
80	784.53	785.51	786.49	787.47	788.45	789.44	790.42	791.40	792.38	793.36
81	794.34	795.32	796.30	797.28	798.26	799.24	800.22	801.20	802.18	803.16
82	804.15	805.13	806.11	807.09	808.07	809.05	810.03	811.01	811.99	812.97
83	813.95	814.93	815.91	816.89	817.87	818.86	819.84	820.82	821.80	822.78
84	823.76	824.74	825.72	826.70	827.68	828.66	829.64	830.62	831.60	832.58
85	833.56	834.74	835.53	836.70	837.68	838.66	839.64	840.62	841.60	842.58
86	843.37	844.35	845.72	846.51	847.49	848.47	849.45	850.43	851.41	852.39
87	853.18	854.16	855.14	856.12	857.10	858.08	859.06	860.04	861.02	862.00
88	862.99	863.97	864.95	865.93	866.91	867.89	868.87	869.85	870.83	871.81
89	872.79	873.77	874.75	875.73	876.71	877.70	878.68	879.66	880.64	881.62
90	882.60	883.58	884.56	885.54	886.52	887.50	888.48	889.46	890.44	891.23
91	892.41	893.39	894.37	895.35	896.33	897.31	898.28	899.27	900.25	901.23
92	902.21	903.19	904.17	905.15	906.13	907.12	908.10	909.08	910.06	911.04
93	912.02	913.00	913.98	914.96	915.94	916.92	917.90	918.88	919.86	920.84
94	921.83	922.81	923.79	924.77	925.75	926.73	927.71	928.69	929.67	930.65
95	931.63	932.61	933.59	934.57	935.55	936.54	937.54	938.50	939.48	940.46
96	941.44	942.42	943.40	944.38	945.36	946.34	947.32	948.30	949.28	950.26
97	951.25	952.23	953.21	954.19	955.17	956.15	957.13	958.11	959.09	960.07
98	961.05	962.03	963.01	963.99	964.97	965.96	966.94	967.92	968.90	969.88
99	970.86	971.84	972.82	973.80	974.72	975.76	976.74	977.72	978.70	979.68
100	980.66									

SMAW  
 SAW  
 GMAW  
 GTAW  
 FCAW  
 Non-FERROUS  
**APPENDIX**

# Reference Material

## 7 Temperature conversion table

0~45			46~91			92~450			460~910		
°C	°F		°C	°F		°C	°F		°C	°F	
-17.8	0	32	7.7	46	114.8	33.3	92	197.6	238	460	860
-17.2	1	33.8	8.2	47	116.8	33.8	93	199.4	243	470	878
-16.7	2	35.6	8.8	48	118.8	34.4	94	201.2	249	480	896
-16.1	3	37.4	9.3	49	120.2	34.8	95	203.0	254	490	914
-15.6	4	39.2	9.9	50	122.0	35.5	96	204.8	260	500	932
-15.0	5	41.0	10.4	51	123.8	36.1	97	206.6	265	510	950
-14.4	6	42.8	11.1	52	125.8	36.6	98	208.4	271	520	968
-13.9	7	44.6	11.5	53	127.4	37.1	99	210.2	276	530	986
-13.3	8	46.4	12.1	54	129.2	37.7	100	212.0	282	540	1004
-12.8	9	48.2	12.6	55	131.0	38	100	212	288	550	1022
-12.2	10	50.0	13.2	56	132.8	43	110	230	293	560	1040
-11.7	11	51.8	13.7	57	134.6	49	120	248	299	570	1058
-11.1	12	53.6	14.3	58	136.4	54	130	266	304	580	1076
-10.6	13	55.4	14.8	59	138.4	60	140	284	310	590	1094
-10.0	14	57.2	15.6	60	140.0	65	150	302	315	600	1112
-9.4	15	59.0	16.0	61	141.8	71	160	320	321	610	1130
-8.9	16	60.8	16.6	62	143.6	76	170	338	326	620	1148
-8.3	17	62.6	17.1	63	145.4	83	180	356	332	630	1166
-7.7	18	64.4	17.7	64	147.2	88	190	374	338	640	1184
-7.2	19	66.2	18.2	65	149.0	93	200	392	343	650	1202
-6.7	20	68.0	18.8	66	150.8	99	210	410	349	660	1220
-6.1	21	69.8	19.3	67	152.6	100	212	413	354	670	1238
-5.6	22	71.6	19.9	68	154.4	104	220	428	360	680	1256
-5.0	23	73.4	20.4	69	156.2	110	230	446	365	690	1274
-4.4	24	75.2	21.0	70	158.0	115	240	464	371	700	1292
-3.9	25	77.0	21.5	71	159.8	121	250	482	376	710	1310
-3.3	26	78.8	22.2	72	161.6	127	260	500	382	720	1328
-2.8	27	80.6	22.7	73	163.4	132	270	518	387	730	1346
-2.2	28	82.4	23.3	74	165.2	138	280	536	393	740	1364
-1.7	29	84.2	23.8	75	167.0	143	290	554	399	750	1382
-1.1	30	86.0	24.4	76	168.8	149	300	572	404	760	1400
-0.6	31	87.8	25.0	77	170.6	154	310	590	410	770	1418
0	32	89.6	25.5	78	172.4	160	320	608	415	780	1436
0.6	33	91.4	26.2	79	174.2	165	330	626	421	790	1454
1.1	34	93.2	26.8	80	176.0	171	340	644	426	800	1472
1.7	35	95.0	27.3	81	177.8	177	350	662	432	810	1490
2.2	36	96.8	27.7	82	179.6	182	360	680	438	820	1508
3.3	38	100.4	28.8	84	183.2	193	380	716	449	840	1544
3.9	39	102.2	29.3	85	185.0	199	390	734	454	850	1562
4.4	40	104.0	29.9	86	186.8	204	400	752	460	860	1580
5.0	41	105.8	30.4	87	188.6	210	410	770	465	870	1598
5.6	42	107.6	31.0	88	190.4	215	420	788	471	880	1616
6.1	43	109.3	31.5	89	192.2	221	430	806	476	890	1634
6.7	44	111.2	32.1	90	194.0	226	440	824	482	900	1652
7.2	45	113.0	32.6	91	195.8	232	450	842	487	910	1670

920-1370			1380-1830			1840-2290			2300-2750		
°C	°F	°F	°C	°F	°F	°C	°F	°F	°C	°F	°F
493	920	1688	748	1380	2516	1003	1840	3344	1260	2300	4172
498	930	1706	752	1390	2534	1008	1850	3362	1266	2310	4190
504	940	1724	760	1400	2552	1014	1860	3380	1271	2320	4208
510	950	1742	765	1410	2570	1019	1870	3398	1277	2330	4244
520	970	1778	776	1430	2606	1030	1890	3434	1288	2350	4262
526	980	1796	782	1440	2624	1036	1900	3452	1293	2360	4280
532	990	1814	787	1450	2642	1041	1910	3470	1299	2370	4298
538	1000	1832	793	1460	2660	1047	1920	3488	1304	2380	4316
543	1010	1850	798	1470	2678	1052	1930	3506	1310	2390	4334
549	1020	1868	804	1480	2696	1058	1940	3524	1316	2400	4552
555	1030	1886	809	1490	2714	1063	1950	3542	1321	2410	4370
560	1040	1904	815	1500	2732	1069	1960	3560	1327	2420	4388
565	1050	1922	820	1510	2750	1074	1970	3578	1332	2430	4406
571	1060	1940	827	1520	2768	1080	1980	3596	1338	2440	4424
576	1070	1958	831	1530	2786	1085	1990	3614	1343	2450	4442
582	1080	1976	838	1540	2804	1093	2000	3632	1349	2460	4460
587	1090	1994	842	1550	2822	1099	2010	3650	1354	2470	4478
593	1100	2012	849	1560	2840	1104	2020	3668	1360	2480	4496
604	1120	2048	860	1580	2876	1116	2040	3704	1371	2500	4532
609	1130	2066	864	1590	2894	1124	2050	3722	1377	2510	4550
616	1140	2084	871	1600	2912	1127	2060	3740	1382	2520	4568
620	1150	2102	876	1610	2930	1132	2070	3758	1388	2530	4586
626	1160	2120	882	1620	2948	1138	2080	3776	1393	2540	4604
631	1170	2138	887	1630	2966	1143	2090	3794	1399	2550	4622
637	1180	2156	893	1640	2984	1149	2100	3812	1404	2560	4640
642	1190	2174	898	1650	3002	1154	2110	3830	1410	2570	4658
648	1200	2192	904	1660	3020	1160	2120	3848	1416	2580	4676
653	1210	2210	909	1670	3038	1166	2130	3866	1421	2590	4694
659	1220	2228	915	1680	3056	1171	2140	3884	1427	2600	4712
664	1230	2246	920	1690	3074	1177	2150	3902	1432	2610	4730
670	1240	2264	926	1700	3092	1182	2160	3920	1438	2620	4748
675	1250	2282	934	1710	3110	1188	2170	3938	1443	2630	4766
682	1260	2300	937	1720	3128	1193	2180	3956	1449	2640	4784
686	1270	2318	942	1730	3146	1199	2190	3974	1454	2650	4802
692	1280	2336	948	1740	3164	1204	2200	3992	1460	2660	4820
697	1290	2354	953	1750	3182	1210	2210	4010	1466	2670	4838
704	1300	2372	959	1760	3200	1216	2220	4028	1471	2680	4856
708	1310	2390	964	1770	3218	1221	2230	4046	1477	2690	4874
715	1320	2408	970	1780	3236	1227	2240	4064	1482	2700	4892
719	1330	2426	975	1790	3255	1232	2250	4082	1488	2710	4910
726	1340	2444	981	1800	3272	1238	2260	4100	1493	2720	4928
734	1350	2462	986	1810	3290	1243	2270	4118	1499	2730	4946
737	1360	2480	992	1820	3308	1249	2280	4136	1504	2740	4964
741	1370	2498	997	1830	3326	1254	2290	4154	1510	2750	4982

# Reference Material

## 8 Unit conversion table of inch and millimeter

Conversion Factor: 1inch = 25.4mm

Inch		mm	Inch		mm
1/64	0.015625	0.3937	33/64	0.515625	13.0969
1/32	0.03125	0.7938	17/32	0.53125	13.4938
3/64	0.046875	1.1906	35/65	0.546875	13.8906
1/16	0.0625	1.5875	9/16	0.5625	14.2875
5/64	0.078125	1.9844	37/64	0.578125	14.6844
3/32	0.09375	2.3812	19/32	0.59375	15.0821
7/64	0.109375	2.7781	39/64	0.607375	15.4781
1/8	0.125	3.175	5/8	0.625	15.875
9/64	0.140625	3.5719	41/64	0.640625	16.2719
5/32	0.15625	3.9688	23/32	0.65625	16.6688
11/64	0.171875	4.3656	43/64	0.671875	17.656
3/16	0.1875	4.7625	11/16	0.6875	17.4625
13/64	0.203125	5.1554	45/64	0.703125	17.8554
7/32	0.21875	5.5562	23/32	0.71875	18.2562
15/64	0.234375	5.9531	47/64	0.734375	18.6531
1/4	0.25	6.35	3/4	0.75	19.05
17/64	0.265625	6.7459	49/64	0.785625	19.4469
9/32	0.28125	7.1438	25/32	0.75125	19.8438
19/64	0.296875	7.5406	51/64	0.796895	20.2406
5/16	0.3125	7.9375	13/16	0.8125	20.6375
21/64	0.328125	8.3344	53/64	0.828125	21.0344
11/32	0.34375	8.7312	27/32	0.74375	21.4312
23/64	0.359375	9.1281	55/64	0.859375	21.8241
3/8	0.375	9.525	7/8	0.875	22.225
25/64	0.390625	9.9219	57/64	0.890625	22.6219
13/32	0.40625	10.3188	29/32	0.90625	23.0188
27/64	0.421875	10.7156	59/64	0.921875	23.4156
7/16	0.4375	11.112	15/16	0.9375	23.8125
29/64	0.453125	11.5094	61/64	0.953125	24.2094
15/32	0.46875	11.9062	31/32	0.96875	24.6082
31/64	0.484375	12.3031	63/64	0.984375	25.0031
1/2	0.5	12.7	1	1	25.4

## Length

Meter	Inch	Feet	Yard	Mile
0.30303	11.9305	0.994211	0.331403	0.000188
1.81818	71.5832	5.96527	1.98842	0.001129
3927.27	154619	12884.9	4294.99	2.44033
1	39.3707	3.28089	1.09363	0.000621
0.025399	1	0.08333	0.027777	0.000015
0.030494	12	1	0.333333	0.00189
0.914383	36	3	1	0.00568
1609.31	63360	5280	1760	1

## Weight

Gram	Kilogram	Ounce	Pound	Long Ton	Short Ton
3750	5.75	132.28	8.2672	0.00375	0.004133
600	0.6	21.1647	1.32279	0.0006	0.000661
1	0.001	0.03527	0.0022	0.000001	0.000001
1000	1	35.273	2.20459	0.001	0.001102
28.3495	0.02835	1	0.0525	0.000028	0.000031
453.592	0.45359	16	1	0.00045	0.0005
1016047	36	35840	2240	1	1.12
907178	63360	32000	2000	0.892857	1

# Reference Material

## 9 Steel plate weight table

Thickness		Weight		Weight/plate					
mm	inch	kg/ft <sup>2</sup>	lb/ft <sup>2</sup>	3 feet × 6 feet		4 feet × 8 feet		5 feet × 10 feet	
				kg	lb	kg	lb	kg	lb
1	0.0394	0.7293	1.608	13.1	28.94	23.3	51.46	36.5	80.40
1.2	0.0172	0.8752	1.930	15.8	34.74	28.0	61.76	43.8	86.50
1.4	0.0551	1.021	2.251	18.4	40.52	32.7	72.03	51.1	112.6
1.6	0.0630	1.167	2.573	21.0	46.31	37.3	82.34	58.4	128.7
1.8	0.0709	1.313	2.895	23.6	52.11	42.0	92.64	65.7	144.8
2	0.0787	1.459	3.217	26.3	57.91	46.7	102.9	73.0	160.9
2.3	0.0906	1.677	3.697	30.2	66.55	53.7	118.3	83.9	184.9
2.6	0.1024	1.896	4.180	34.1	75.24	60.7	133.8	94.8	209.0
2.9	0.1142	2.115	4.663	38.1	83.93	67.7	142.2	106	233.2
3.2	0.1260	2.334	5.146	42.0	92.63	74.7	164.7	117	257.3
3.5	0.1378	2.553	5.628	46.0	101.3	81.7	180.1	128	281.4
4	0.1575	2.917	6.431	52.5	115.8	93.3	205.8	146	321.6
4.5	0.1772	3.282	8.040	65.6	144.7	117	257.3	182	402.0
5	0.1969	3.647	8.040	65.6	144.7	117	257.3	182	402.0
5.5	0.2165	4.011	8.843	72.2	159.2	128	283.0	201	442.2
6	0.2362	4.376	9.647	78.8	173.6	140	308.7	219	482.4
6.5	0.2559	4.740	10.45	85.3	188.1	152	334.4	237	522.5
7	0.2756	5.105	11.25	91.9	202.5	163	360.0	255	562.5
8	0.3150	5.834	14.47	118	260.5	210	463.0	328	723.5
10	0.3937	7.293	16.08	131	289.4	233	514.6	365	804.0
11	0.4331	8.022	17.69	144	318.4	257	566.1	401	884.5
12	0.4724	8.752	19.30	158	347.4	280	617.6	438	965.0



Thickness		Weight		Weight/plate					
mm	inch	kg/ft <sup>2</sup>	lb/ft <sup>2</sup>	3 feet × 6 feet		4 feet × 8 feet		5 feet × 10 feet	
				kg	lb	kg	lb	kg	lb
13	0.5118	9.481	20.90	171	376.2	303	668.8	474	1045
14	0.5512	10.21	22.51	184	405.2	327	720.3	511	1126
15	0.5906	10.94	24.12	197	434.2	350	771.8	547	1206
16	0.6299	11.67	25.73	210	463.1	373	823.4	584	1287
19	0.7480	13.86	30.56	249	550.1	444	979.9	693	1528
22	0.8661	16.04	35.36	389	636.5	513	1132	802	1768
25	0.9843	18.23	40.19	328	723.4	583	1286	912	2010
28	1.1024	20.42	45.02	368	810.4	653	1441	1021	2251
32	1.2598	23.34	51.46	420	926.3	747	1647	1167	2573
36	1.4173	26.25	57.87	473	1042	840	1852	1313	2894
40	1.5348	29.17	64.31	525	1158	933	2058	1459	3216
45	1.7717	32.82	72.35	591	1302	1050	2315	1641	3618
50	1.9685	36.47	80.40	656	1447	1167	2573	1824	4020
1/32	0.7938	0.5789	1.276	10.4	22.97	18.5	40.83	28.9	63.8
1/16	1.5875	1.158	2.553	20.8	45.95	37.1	81.70	57.9	127.7
3/32	2.3813	1.737	3.829*	31.3	68.92	55.6	122.5	86.9	191.5
1/8	3.1750	2.316	5.106	41.7	91.91	74.1	163.5	116	255.3
5/32	3.9688	2.894	6.380	52.1	114.8	92.6	204.2	145	319.0
3/16	4.7625	3.473	7.657	62.5	137.8	111	245.0	174	382.9
7/32	5.5563	4.052	8.933	72.9	160.8	130	285.9	203	446.7
1/4	6.3500	4.631	10.21	83.4	183.8	148	326.7	232	510.5
9/32	7.1438	5.210	11.49	93.8	206.8	167	367.7	261	574.5

# Approvals

Classification			Welding Position	Register of shipping & size(mm)		
Brand Name	KS	AWS		KR	ABS	LR
S-4301.I	E4301	E6019	All F	3 2.6-6.0	3 2.6-6.0	3 2.6-6.0
S-4303.V	E4303		All F, H-Fil	3 2.6-6.0	3 2.6-6.0	3 2.6-6.0
S-6010.D		E6010	All F, H-Fil	2 2.6-6.0	2 2.6-6.0	2 2.6-6.0
S-6011.D	E4311	E6011	All F, H-Fil	2 2.6-6.0	2 2.6-6.0	2 2.6-6.0
S-6013.LF	E4313	E6013	All F, H-Fil	2 2.6-6.0	2 2.6-6.0	2 2.6-6.0
S-6013.V	E4313	E6013	All V-down	2 2.6-5.0	2 2.6-5.0	2 2.6-5.0
S-6027.LF	E4327	E6027	F, H-Fil	3 4.0-8.0	3 4.0-8.0	3, 3G 4.0-8.0
S-7016.H	E5016	E7016	All F	3H10, 3YH10 2.6-6.0	3H10, 3Y 2.6-6.0	3, 3YH15 2.6-6.0
S-7016.LF	E5016	E7016	All	3H10, 3Y H10 2.6-6.0	3H10, 3Y 2.6-6.0	3, 3YH15 2.6-6.0
S-7016.LS	DL5016-6AP1	E7016-G	All F, H-Fil	3H10, 3YH10 (-60°C) 2.6-6.0	3H10, 3Y (-60°C) 2.6-6.0	5Y40H15 2.6-6.0
S-76LTH	DL5016-6AP1	E7016-G	All		5Y, 5Y400 H5 2.6-5.0	
S-7016.M	E4316	E7016	All F	3H10, 3YH10 2.6-6.0	3H10, 3Y 2.6-6.0	
S-7016.O	E4316	E7016	All	3H10, 3YH10 3.2-5.0	3H10, 3Y 2.6-5.0	3, 3YH15 2.6-5.0
S-7018.G	E5016	E7018	All F	3H10, 3Y H10 2.6-6.0	3H10, 3Y 2.6-6.0	3, 3YH15 2.6-6.0
S-7018.1	E5016	E7018-1	All		3H10, 3Y 2.6-5.0	3, 3YH15 2.6-5.0
S-7018.1H	E5016	E7018-1	All		4YH5 2.6-5.0	4YH5 2.6-5.0
S-7014.F	E4313	E7014	All F, H-Fil	2, 2Y 2.6-6.0	2Y 2.6-6.0	2, 2Y 2.6-6.0
S-7024.F	E4324	E7024	F, H-Fil		2 3.2-7.0	2, 2Y, 2YG 3.2-6.0
S-7028.F	E5026	E7028	F, H-Fil	3Y 3.2-7.0	3, 3Y 3.2-7.0	3, 3Y, 3YG 4.0-7.0
S-7048.V	E5026	E7048	All, F, H-Fil V-down	3H10, 3YH10 3.2-6.0	3H10, 3Y 3.2-6.0	3, 3YH15 3.2-6.0
S-7010.A1		E7010-A1	All F, H-Fil		AWS A5.5 E7010-A1 2.6-6.0	2Y 2.6-6.0
S-8016.B2		E8016-B2	All F, H-Fil		AWS A5.5 E8016-B2 2.6-6.0	
S-8018.B2		E8018-B2	All F, H-Fil		AWS A5.5 E8018-B2 2.6-6.0	
S-9018.B3		E9018-B2	All F, H-Fil	AWS A5.5 E9018-B3 3.2-6.0	AWS A5.5 E9018-B3 3.2-6.0	AWS A5.5 E9018-B3 3.2-6.0
S-8016.G	E5316	E8016-G	All		AWS A5.5 E8016-G 2.6-6.0	

Register of shipping & size(mm)

BV	DNV	GL	NK	TÜV	DB
3 2.6-6.0	3 2.6-6.0	3 2.6-6.0	KMW3 2.6-6.0		
3 2.6-6.0	3 2.6-6.0	3 2.6-6.0	KMW3 2.6-6.0		
2 2.6-6.0	2 2.6-6.0	2 2.6-6.0	KMW2 2.6-6.0		
2 2.6-6.0	2 2.6-6.0	2 2.6-6.0	KMW2 2.6-6.0		
2 2.6-6.0	2 2.6-6.0	2 2.6-6.0	KMW2 2.6-6.0		
			KMW2 2.6-5.0	EN ISO 2560-A E 38 0 RC 1 1	
3 4.0-8.0	3 4.0-8.0	3 4.0-8.0	KMW3 4.0-8.0		
3YHH 2.6-6.0	3YH10 2.6-6.0	3YH10 2.6-6.0	KMW53HH 2.6-6.0		
3, 3YHH 2.6-6.0	3YH10 2.6-6.0	3YH10 2.6-6.0	KMW53HH 2.6-6.0		
3, 3YHH (-60°C) 2.6-6.0	5YH10 2.6-6.0				
	5Y40H5, NV4-4L 2.6-5.0				
			KMW53HH 2.6-6.0		
	3YH10 2.6-5.0		KMW53HH 3.2-5.0		
3YHH 2.6-6.0	3YH10 2.6-6.0	3YH10 2.6-6.0	KMW53HH 2.6-6.0	EN ISO 2560-A E 42 3 B 1 2 H5	
3Y HH 2.6-5.0	3YH10 2.6-5.0	3YH10 2.6-5.0			
4Y HHH 2.6-5.0	4YH5 2.6-5.0	4YH5 2.6-5.0			
2, 2Y 2.6-6.0	2 2.6-6.0	2Y 2.6-6.0	KMW52 2.6-6.0		
	2 (25 t) 3.2-7.0		KMW2, KMW52 3.2-6.0		
3, 3Y 3.2-7.0	3 (25 t) 3.2-7.0	3Y 3.2-7.0	KMW3, KMW53 4.0-7.0		
3, 3YHH 3.2-6.0	3YH10 3.2-6.0	3YH10 3.2-6.0	KMW53HH 3.2-6.0		
	H10 NV2, 25Cr1Mo 3.2-6.0				

SMW

SAW

GMAW

GTAW

FCAW

Non-FERROUS

APPENDIX

# Approvals

Classification			Welding Position	Register of shipping & size(mm)		
Brand Name	KS	AWS		KR	ABS	LR
S-9016.G	E5816	E9016-G	All		AWS A5.5 E9016-G 2.6-6.0	
S-10016.G	E7016	E10016-G	All		AWS A5.5 E10016-G 2.6-6.0	
S-11016.G	E8016	E11016-G	All		AWS A5.5 E11016-G 2.6-6.0	
S-9018.M		E9018-M	All		AWS A5.5 E9018-M 2.6-5.0	
S-11018.M		E11018-M	All F, H-Fil		AWS A5.5 E11018-M 2.6-6.0	
S-308.16N	E308.16	E308-16	All F, H-Fil	RD308 2.4-5.0	AWS A5.4 E308-16 2.4-5.0	
S-308L.16N	E308L.16	E308L-16	All F, H-Fil	RD308L 2.4-5.0	AWS A5.4 E308L-16 2.4-5.0	304L 2.4-5.0
S-308LT.16	E308L.16	E308L-16	All		AWS A5.4 E308L-16 (-196°C) 2.0-4.0	
S-308L.17		E308L-17	All F, H-Fil		AWS A5.4 E308L-17 2.0-5.0	
S-309.16N	E309.16	E309-16	All F, H-Fil	RD309 2.4-5.0	AWS A5.4 E309-16 2.4-5.0	SS/CMn 2.4-5.0
S-309L.16	E309L.16	E309L-16	All F, H-Fil	RD309L 2.0-5.0	AWS A5.4 E309L-16 2.0-5.0	SS/CMn 2.0-5.0
S-309L.17		E309L-17	All F, H-Fil		AWS A5.4 E309L-17 2.0-5.0	
S-309Mo.16	E309Mo.16	E309Mo-16	All F, H-Fil		AWS A5.4 E309Mo-16 2.4-5.0	
S-309MoL.16	E309MoL.16	E309LMo-16	All F, H-Fil			
S-316.16N	E316.16	E316-16	All F, H-Fil	RD316 2.6-5.0	AWS A5.4 E316-16 2.4-5.0	
S-316L.16N	E316L.16	E316L-16	All F, H-Fil	RD316L 2.4-5.0	AWS A5.4 E316L-16 2.4-5.0	316L 2.4-5.0
S-316LT.16	E316L.16	E316L-16	All		AWS A5.4 E316L-16 (-196°C) 2.0-4.0	
S-316L.17		E316L-17	All F, H-Fil		AWS A5.4 E316L-17 2.0-5.0	
SR-625		ENiCrMo-3	All		AWS A5.11 ERNiCrMo-3 3.2-4.0	
ST-2209/ I1		ER2209	All		AWS A5.9 ER2209 (-50) 0.8-3.2	S31803m 1.6-3.2
ST-308/ I1	Y308	ER308	All	RY308G 0.8-3.2	AWS A5.9 ER308 0.8-3.2	
ST-308L/ I1	Y308L	ER308L	All	RY308L (-196°C) 0.8-3.2	AWS A5.9 ER308L 0.8-3.2	304L (-196°C) 0.8-3.2
ST-309/ I1	Y309	ER309	All		AWS A5.9 ER309 0.8-3.2	
ST-309L/ I1	Y309L	ER309L	All		AWS A5.9 ER309L 0.8-3.2	SS/CMn 0.8-3.2
ST-316/ I1	Y316	ER316	All		AWS A5.9 ER316 0.8-3.2	

Register of shipping & size(mm)					
BV	DNV	GL	NK	TÜV	DB
	308 2.4-5.0				
308L 2.0-5.0	308L 2.4-5.0		KD308L 2.4-5.0	EN ISO 3581-A E 19 9 L R	DIN EN ISO 3581-A E 19 9 L R
	309 2.4-5.0				
UP (E309L-16) 2.0-5.0	309L 2.0-5.0	4332 2.0-5.0	KD309L 2.0-5.0	EN ISO 3581-A E 23 12 L R	DIN EN ISO 3581-A E 23 12 L R
	309MoL (-20°C) 2.6-5.0			EN ISO 3581-A E 23 12 2 L R	DIN EN ISO 3581-A E 23 12 2 L R
UP (E316-16, -20°C) 2.0-5.0	316 2.4-5.0				
UP (E316L-16, -20°C) 2.0-5.0	316L 2.4-5.0		KD316L 2.0-5.0	EN ISO 3581-A E 19 12 3 L R	DIN EN ISO 3581-A E 19 12 3 L R
	Duplex Stainless Steel 1.6-3.2				
	308 0.8-3.2				
UP (KV -196°C) 0.8-3.2	308L (-196°C) 0.8-3.2		KY308L 0.8-3.2		
309L 0.8-3.2	309L 0.8-3.2		KY309L 0.8-3.2		

SMAW

SAW

GMAW

GTAW

FCAW

Non-FERROUS

APPENDIX

# Approvals

Classification			Welding Position	Register of shipping & size(mm)		
Brand Name	KS	AWS		KR	ABS	LR
ST-316L/ I1	Y316L	ER316L	All	RY316L (-196°C) 0.8-3.2	AWS A5.9 ER316L 0.8-3.2	316L (-196°C) 0.8-3.2
SM-309/ I1	Y309	ER309	F		AWS A5.9 ER309 0.8-3.2	
SM-316L/ I1	Y316L	ER316L	F		AWS A5.9 ER316L 0.8-3.2	
SMT-2594		ER2594	All		AWS A5.9 ER2594 1.0-3.2	
SMT-625/ I1 T:1.0-1.6 M:1.0-3.2		ERNiCrMo-3	All	L92S 1.0-3.2	AWS A5.14 ERNiCrMo-3 (-196°C) 1.0-3.2	9Ni H15 1.0-3.2
SMT-7030/ I1		ERCuNi	All		AWS A5.7 ERCuNi 1.0-3.2	
ST-9010/ I1	YCuNi-1		All	KS D7044 YCuNi-1 1.6-3.2		
ST-50G/ I1	YGT50	ER70S-G	All	3YSG 1.2-3.2	AWS A5.18 ER70S-G 1.2-3.2	3, 3Y H15 1.2-3.2
ST-50.3/ I1		ER70S-3	All		AWS A5.18 ER70S-3 (-50°C) 0.8-3.2	
ST-50.6/ I1	YGT50	ER70S-6	All		AWS A5.18 ER70S-6 (-30°C) 1.6-3.2	
ST-1N		ER80S-Ni1	All		AWS A5.28 ER80S-Ni1 (-50°C) 1.6-3.2	
SM-70/ C1	YGW12	ER70S-6	All (Except OH)	3SG, 3YSG(C) 0.8-1.6	3SA, 3YSA 0.8-1.6	3S, 3YS H15 0.8-1.6
SM-70/ M21	YGW12	ER70S-6	F, H-Fil	3YSG(M2), 3YMG(M2) 0.8-1.6	3SA, 3YSA 0.8-1.6	3YS, 3YM H15 0.8-1.6
SM-70EN/ C1	YGW12	ER70S-6	All V-down			
SM-70EN/ M21	YGW12	ER70S-6	All V-down			
SM-70G/ C1	YGW11	ER70S-G	F, H-Fil	3SG, 3YSG, 3MG, 3YMG (C1) 0.8-1.6	3SA, 3YSA 0.8-1.6	3YS H15 0.8-1.6
SM-70G/ M21	YGW11	ER70S-G	F, H-Fil		3SA, 3YSA 0.8-1.6	
SM-70GS/ M21	YGW15	ER70S-G	All			3YS H15 0.8-1.6
SM-70S/ C1	YGW16	ER70S-3	All		3SA, 3YSA 0.8-1.6	3S, 3YS H15 0.8-1.6
SM-70S/ M21	YGW16	ER70S-3	All		3SA, 3YSA 0.8-1.6	3S, 3YS H15 0.8-1.6
SM-80G/ C1	YGW21	ER80S-G	All		AWS A5.28 ER80S-G (-20°C) 1.0-1.6	
SM-70 Copper Free/ C1	YGW12	ER70S-6	All		3SA, 3YSA 0.8-1.6	
SM-70 Copper Free/ M21	YGW12	ER70S-6	All		3SA, 3YSA 0.8-1.6	
SM-70G Copper Free/ C1	YGW11	ER70S-G	F		3SA, 3YSA 0.8-1.6	
SM-70G Copper Free/ M21	YGW11	ER70S-G	F		3SA, 3YSA 0.8-1.6	

Register of shipping & size(mm)

BV	DNV	GL	NK	TÜV	DB
316L (KV -196°C) 0.8-3.2	316L (-196°C) 0.8-3.2	4435 0.8-3.2	KY316L 0.8-3.2		
AWS A5.14 ERNiCrMo-3 1.0-3.2	MS NV 1.5Ni, 9Ni 1.0-3.2	NiCr21Mo9Nb 1.0-3.2	KSWL92 1.0-3.2		
UP (-20°C) 1.2-3.2	IIIYM 1.2-3.2	3Y 1.2-3.2	KSW53G 1.2-3.2		
				EN ISO 636-A - W 42 5 W3Si1	
SA3, SA3YM 0.8-1.6	IIIYMS 0.8-1.6	3YS 0.8-1.6	KSW53G(C) 0.8-1.6	EN ISO 14341-A G42 2 C1 3Si1	DIN EN ISO 14341-A G 42 2 C1 3Si1
SA3YM 0.8-1.6	IIIYMS 0.8-1.6	3YS 0.8-1.6	KSW53G, KAW53MG (M2) 0.8-1.6	EN ISO 14341-A G42 3 M21 3Si1	DIN EN ISO 14341-A G 42 3 M21 3Si1
	IIIY40MS 0.8-1.6	3Y40S 0.8-1.6		EN ISO 14341-A G42 2 C1 4Si1	DIN EN ISO 14341-A G 42 2 C1 4Si1
	IIIY40MS 0.8-1.6	3Y40S 0.8-1.6		EN ISO 14341-A G46 4 M21 4Si1	DIN EN ISO 14341-A G 46 4 M21 4Si1
SA3, 3YM 0.8-1.6	IIIYMS 0.8-1.6	3YS 0.8-1.6	KSW53G, KAW53MG(C) 0.8-1.6		
	IIIYMS 0.8-1.6		KSW3G, KSW53G(M2) KAW3MG, KAW53MG(M2) 0.8-1.6		

SMAW

SAW

GMAW

GTAW

FCAW

Non-FERROUS

APPENDIX

# Approvals

Classification			Welding Position	Register of shipping & size(mm)		
Brand Name	KS	AWS		KR	ABS	LR
SC-EG2 Cored/ CBM600/C1		EG70T-2	V	3V, 3YV 1.6	3, 3YH10 1.6	3, 3Y 1.6
SC-EG2 Cored/ WS-600/C1		EG70T-2C	V-Up	3YV 1.6	3Y 1.6	
SC-EG3/ BS-SG/C1		EG82T-NM2	V-up	4Y40VH5 1.6	5Y400 H5 1.6	4Y40 H5 1.6
SC-460/ C1	YFL-C506R	E81T1- C1A6-K2	All V-down	5Y46SG(C1) H5 1.2~1.4	5YQ460SA H5 1.2-1.4	5Y46 H5 1.2~1.4
SC-70ML/ M21	YFW-A50DM	E70T15- M21A4-CS1	F, V H-Fil		4Y400SA H5 1.2-1.6	4Y40S H5 1.2-1.6
SC-70H Cored/ C1	YFW-C502M	E70T1- C1A2-CS1	F		3YSA H10 1.6-2.4	3YS H10 1.6-2.4
SC-70T Cored/ C1	YFW-C50DM	E70T15- C1A0-CS1	All		3YSAH10, 3YSA 1.2	3YS H10 1.2
SC-70T Cored/ M21	YFW-C50DM	E70T15- M21A2-CS1	All			3YS H5 1.2~1.6
SC-71HJ/ C1	YFW-C504R	E71T1- C1A4-CS1	All V-down	4Y40SG(C1)H10 1.2-1.4	4Y400SA H10 1.2-1.4	4Y40S H10 1.2-1.4
SC-71LH/ C1	YFW-C502R	E71T1- C1A2-CS1	All V-down	3YSG(C)H5 1.2~1.6	3YSA H5 1.2-1.6	3YS H5 1.2-1.6
SC-71LHM Cored/ M21		E71T1- M21A2-CS1	All V-down		3YSA H5 1.2~1.6	3YS H5 1.2~1.6
SC-71MJ		E71T1- M21A4-CS1	All V-down		4YSA, 4Y400SA H5 1.2~1.6	4Y40 H5 1.2~1.6
SC-71MSR/ M21		E71T1- M21A5-CS2	All V-down		4Y400SA H5 1.2	4Y40S H5 1.2
SC-71SR/ C1	YFL-C503R	E71T1- C1A6-CS2 H4	All V-down		4Y400SA H5 1.2-1.6	4Y40S H5 1.2~1.6
SC-81LT/ C1		E81T1- C1A6-K2	All V-down		5Y, 5Y400SAH5 1.2	5Y40S H5 1.2
SC-80MR/ M21		E80T15- M21A8-G	All			
SC-80K2/ C1		E80T1- C1A8-K2 H4	H-F	RSW54Y40MG(C)HHH 1.2-1.4	5Y400SA H5 1.2-1.4	4Y40S H5 1.2-1.4
2 X SC-80K2/ C1		E80T1- C1A8-K2 H4	H-F	RSW54Y40MG(C)HHH 1.2-1.4	5Y400SA H5 1.2-1.4	4Y40M H5 1.2-1.4
SC-81Ni2/ C1		E81T1- C1A8-Ni2	All V-down	5Y46SG(C1) H5 1.2~1.4	5YQ460SA H5 1.2-1.4	
SC-81Ni2M/ M21		E81T1- M21A8-Ni2	All V-down			
SC-81SR/ C1		E81T1- C1A8-K2	All V-down		5Y400SA H5 1.2	5Y40S H5, 5Y40srS 1.2
SC-81SR/ WS-601/C1		E81T1- C1P8-K2	All V-down			5Y40S H5, 5Y40srS 1.2
SC-91K2 Cored/ C1		E81T1- C1A4-K2	All V-down		AWS A5.29 E91T1-K2C (-40°C) 1.2	
SF-70MX/ C1	YFW-C50DM	E70T1- C1A0-CS1	F, H-Fil	2SG, 2YSG (C1) H10 2MG, 2YMG(C1) H10 1.2-1.6	2SA, 2YSAH10, 2Y400SA 1.2-1.6	2S, 2YS H10 1.2-1.6
SF-71/ C1	YFW-C50DR	E71T1- C1A0-CS1	All V-down	2SMG, 2YSMG(C)H10 1.2-1.6	2SA, 2YSAH10, 2Y400SA 1.2-1.6	2S, 2YS H10 1.2-1.6



Register of shipping & size(mm)

BV	DNV	GL	NK	TÜV	DB
AV3, AV3Y 1.6	IY (-20°C) 1.6	3YV 1.6	KEW53 1.6		
	IIY 1.6	3YV 1.6	KEW53G(C) 1.6		
AV5Y40 HHH 1.6	VY40(H5) NV2-4L, NV4-4L 1.6	6Y40H5V 1.6	KEW54Y40G(C)H5 (-60°C) 1.6		
SA5Y46 HHH 1.2-1.4	VY46MS(H5) 1.2-1.4	6Y46H5 1.2-1.4	KSW5Y46G(C)H5, KSW63Y47G(C)H5 (-20°C) 1.2-1.4		
SA4Y40M HHH 1.2-1.6	IVY40MS H5 1.2-1.6	4Y40H5S 1.2-1.6		EN ISO 17362-A T46 4 M M 2 H5	DIN EN ISO 17632-A T 46 4 M M 2 H5
		3YH10S 1.6-2.4			
SA3YM HH 1.2	IIYMS H10 1.2	3YH10S 1.2		EN ISO 17632-A T46 2 M M / T42 2 M C	DIN EN ISO 17632-A T 42 2 M C 1
SA3Y HHH 1.2-1.6	IIYMS H5 1.2-1.6	3YH5S 1.2-1.6		EN ISO 17632-A T46 2 M M / T42 2 M C	DIN EN ISO 17632-A T 46 2 M M 1
SA4Y40 HH 1.2-1.4	IVY40MS H10 1.2-1.4	4Y40H10S 1.2-1.4	KSW54Y40G(C)H10 1.2-1.4		
SA3Y HHH 1.2-1.6	IIYMS H5 1.2-1.6	3YH5S 1.2-1.6	KSW53Y40G(C) H5 1.2-1.6	EN ISO 17632-A T42 2 P C 1 H5	
SA3Y HHH 1.2-1.6	IIYMSH5 1.2-1.6	3YH5S 1.2-1.6		EN ISO 17632-A T46 3 P M 1 H5	DIN EN ISO 17632-A T 46 3 P M 1 H5
SA4Y, SA4Y40 HHH 1.2-1.6	IVY40MS (H5), IVYMS 1.2-1.6				
SA4Y40M HHH 1.2	IVY40MSH5 1.2	4Y40H5S 1.2		EN ISO 17632-A T46 4 P M 1 H5	DIN EN ISO 17632-A T 46 4 P M 2 H5
SA4Y40 HHH 1.2-1.6	IVY40MSH5 1.2-1.6	4Y40H5S 1.2-1.6			
	VY40MSH5 NV4-4L 1.2-1.4				
		6Y40H5S 1.2-1.4			
SA5Y40 HHH 1.2-1.4	VY40MS H5, NV4-4L 1.2-1.4	6Y40H5S 1.2-1.4	KAW54Y40MG(C), KSW54Y40MG(C)H5 (-60°C) 1.2-1.4		
SA5Y40 HHH 1.2-1.4	VY40MS H5, NV4-4L 1.2-1.4	6Y40H5S 1.2-1.4	KAW54Y40MG(C)H5 (-60°C) 1.2-1.4		
SA5Y46 HHH 1.2-1.4	VY46MS(H5) 1.2-1.4	6Y46S H5 1.2-1.4	KSW63Y47G(C)H5 1.2-1.4		
SA5Y46 HHH 1.2-1.4	VY46MS(H5) 1.2-1.4				
	IVY50MS H5 1.2				
SA2YM HH 1.2-1.6	IIYMSH10 1.2-1.6	2YH10S 1.2-1.6	KSW2G, KSW52Y40G(C)H10 KAW2MG, KAW52MG(C)H10 1.2-1.6		
SA2M, SA2YM HH AZM, AZYM HH 1.2-1.6	IIYMS H15 1.2-1.6	2YH10S 1.2-1.6	KSW52Y40G(C)H10 1.2-1.6	EN ISO 17632-A T 42 0 P C 1	

SMW

SAW

GNM

GTAW

FCAW

Non-FERROUS

APPENDIX

# Approvals

Classification			Welding Position	Register of shipping & size(mm)		
Brand Name	KS	AWS		KR	ABS	LR
SF-71/CBM8061/C1			F, V			2YS H10 1.2-1.4
SF-71/WS-601/C1			F, V			
SF-71LF/C1	YFW-C50DR	E71T1-C1A0-CS1	All V-down		2YSAH10 1.2-1.6	2S, 2YS H10 1.2-1.6
SF-71LF/CBM8061/C1			F, V			2S, 2YS H10 1.2-1.6
SF-71MC/C1		E71T1-C1A2-CS2	All V-down		3YSA H10 1.2-1.6	3YS H10 1.2-1.6
SF-71MC/M21		E71T1-M21A2-CS2	All V-down		3YSA H10 (75%Ar+25%CO <sub>2</sub> ) 1.2-1.6	3YS H10 1.2-1.6
Supercored 70B/M21	YFW-A502B	E71T5-M21A4-CS1 H4	All		3YSAH5 1.0-2.0	3S, 3YS H5 1.0-2.0
Supercored 70B/CBM8061/M21			F, V			3S, 3YS 1.0-2.0
Supercored 70SB/C1	YFW-C502B	E71T5-C1A2-CS1 H4	F, V	3YSG(C1)H5 1.2-1.6	3SA, 3YSAH5 1.2-1.6	3YSH5 1.2-1.6
Supercored 70SB/CBM8061/C1			F, V			3YSH5 1.2-1.6
Supercored 70NS/M21	YFW-A50DM	E70T15-M21A2-CS1	F, H-Fil		3SAH5, 3YSA 0.9-1.6	3S, 3YSH5 0.9-1.6
Supercored 70MXH/C1	YFW-C50DM	E70T1-C1A2-CS1	F, H-Fil	3YSG(C)HHH, 3YMG(C)HHH 1.4-2.0	3SAH5, 3YSA 1.4-2.0	3YSH5 1.4-2.0
2 X Supercored 70MXH/C1	YFW-C50DM	E70T1-C1A2-CS1	F, H-Fil	3YMG(C) HHH 1.4-2.0	3SAH5, 3YSA 1.4-2.0	3YMH5 1.4-2.0
Supercored 110/C1		E111T1-C1A4-G H4	All V-down	3Y69S(C) H5 1.2	AWS A5.29 E111T1-GC-H4 (IV-40°C) 1.2	
Supercored 71/C1	YFW-C502DR	E71T1-C1A0-CS1	All V-down	3SMG, 3YSMG(C) H10 0.9-1.6	3SAH10, 3YSA 0.9-1.6	3S, 3YSH10 0.9-1.6
Supercored 71/CBM8061/C1			All V-down			3S, 3YS 0.9-1.6
Supercored 71H/C1	YFW-C502R	E71T1-C1A4-CS1	All V-down	4YSMG(C) H10 1.2-1.4	4YSAH10 1.2-1.4	4YSH10 1.2-1.4
	YFW-C502R	E71T1-C1A4-CS1	All V-down	3YSMG(C) H10 1.6	3SAH10 1.6	
Supercored 71Hi/C1		E71T1-C1A4-CS1	All		4YSAH5 1.2-1.4	
Supercored 71MAG/M21	YFW-A502R	E71T1-M21A2-CS1	All V-down		3SAH10, 3YSA 1.2-1.6	3S, 3YSH10 1.2-1.6
Supercored 71MAG/CBM8061/M21			All V-down			3YS 1.2-1.4
Supercored 81MAG/M21		E81T1-M21A8-Ni1 H4	All V-down		5Y400SA H5 1.2	5Y40S H5 1.2
Supercored 81-K2/C1	YFL-C506R	E81T1-C1A8-K2 H4	All V-down	4Y40SG(C1) H5 (-60°C) 1.2-1.6	5Y400SA H5 1.2-1.6	5Y40S H5 1.2-1.6
Supercored 81-K2 MAG/M21	YFL-A506R	E81T1-M21A8-K2	All V-down		5Y400SA H5 1.2	5Y40S H5 1.2
SW-2209 Cored/M21		E2209T1-4	All			

Register of shipping & size(mm)

BV	DNV	GL	NK	TÜV	DB
				EN ISO 17632-A T 42 0 P C 1	
			KSW52Y40G (C) 1.2-1.4	EN ISO 17632-A T 42 0 P C 1	
	IIYMSH10 1.2-1.6		KSW52G(C)H10, KAW52MG(C) 1.2-1.6		
SA3YM HH 1.2-1.6	IIYMS H10 1.2-1.6			EN ISO 17632-A T42 2 P C 1 H10	DIN EN ISO 17632-A T 46 2 P C 1 H10
SA3YM HH 1.2-1.6	IIYMS H10 1.2-1.6			EN ISO 17632-A T46 3 P M 1 H10	DIN EN ISO 17632-A T 46 3 P M 1 H10
SA3YM HHH 1.0-2.0	IIYMS H5 1.0-2.0	3YH5S 1.0-2.0		EN ISO 17632-A T 42 4 B M 3 H5	DIN EN ISO 17632-A T 42 4 B M 3 H5
				EN ISO 17632-A T 42 4 B M 3 H5	DIN EN ISO 17632-A T 42 4 B M 3 H5
SA3YM HHH 1.2-1.6	IIYMS H5 1.2-1.6	3YH5S 1.2-1.6	KSW53G(C)H5 1.2-1.6		
SA3M, SA3YM HHH 0.9-1.6	IIYMS H5 0.9-1.6	3YH5S 0.9-1.6		EN ISO 17632-A T 42 3 M M 3	DIN EN ISO 17632-A T 42 2 M M 3
SA3YM, A3YM HHH 1.4-2.0	IIYMS H5 1.4-2.0	3YH5S 1.4-2.0	KSW53G(C)H5, KAW53MG(C)H5 1.4-2.0		
SA3YM, A3YM HHH 1.4-2.0	IIYMS H5 1.4-2.0	3YH5S 1.4-2.0	KAW53MG(C) 1.4-2.0		
SA3M, SA3YM, A3M, A3YM HH 0.9-1.6	IIYMS H10 0.9-1.6	3YH10S 0.9-1.6	KSW53Y40G(C)H10 0.9-1.6	EN ISO 17632-A T 42 2 P C 1	DIN EN ISO 17632-A T 42 2 P C 1
				EN ISO 17632-A T 42 2 P C 1	DIN EN ISO 17632-A T 42 2 P C 1
SA4YM HH 1.2-1.4	IVYSM H5 1.2-1.4	4YS H10 1.2-1.4	KSW54G(C) H10 1.2-1.4	EN ISO 17632-A T 42 2 P C 1	DIN EN ISO 17632-A T 42 2 P C 1
SA3YM HH 1.6	IIYMS H5 1.6	3YS H10 1.6	KSW53G(C) H10 1.6	EN ISO 17632-A T 42 2 P C 1	DIN EN ISO 17632-A T 42 2 P C 1
	IVYMS(H5) 1.2-1.4				DIN EN ISO 17632-A T 42 2 P C 1
SA3M, SA3YM HH A3M, A3YM 1.2-1.6	IIYMS H10 1.2-1.6	3YH10S 1.2-1.6		EN ISO 17632-A T 42 2 P M 1	DIN EN ISO 17632-A T 42 2 P M 1
				EN ISO 17632-A T 42 2 P M 1	DIN EN ISO 17632-A T 42 2 P M 1
SA5Y40M HHH 1.2	VY40MS H5 1.2			EN ISO 17632-A T 46 6 1Ni P M 2 H5	DIN EN ISO 17632-A T 46 6 1Ni P M 2 H5
SA5Y40M HHH 1.2-1.6	VY40MS H5, NV2-4L, 4-4L 1.2-1.6	6Y40H5S 1.2-1.6	KSW54Y40G(C)H5 (-60°C(Butt)) 1.2-1.6		
SA5Y40M HHH 1.2	VY40MS H5 1.2	6Y40S H5 1.2		EN ISO 17632-A T 46 6 1.5 Ni P M 2	DIN EN ISO 17632-A T 46 6 1.5Ni P M 2
UP (KV -20°C) 1.2	Duplex Stainless Steel 1.2				

SMAW

SAW

GMAW

GTAW

FCAW

Non-FERROUS

APPENDIX

# Approvals

Classification			Welding Position	Register of shipping & size(mm)		
Brand Name	KS	AWS		KR	ABS	LR
SW-308L Cored/C1	TS308L-FB1	E308LT1-1	All		AWS A5.22 E308LT1-1 (-120°C) 1.2~1.6	304L (-120°C) 1.2~1.6
SW-308LT/C1	TS308L-FB1	E308LT1-1	All		AWS A5.22 E308LT1-1 (-196°C) 1.2	
SW-308LT/M21	TS308L-FB1	E308LT1-4	All		AWS A5.22 E308LT1-4 (-196°C) 1.2	
SW-309L Cored/C1	TS309L-FB1	E309LT1-1	All	RW309LG (C) (-20°C) 1.2~1.6	AWS A5.22 E309LT1-1 1.2-1.6	SS/CMn 1.2~1.6
SW-309MoL Cored/C1		E309LMoT1-1	All			
SW-309MoL Cored/M21		E309LMoT1-4	All			
SW-316L Cored/C1	TS316L-FB1	E316LT1-1	All	RW316LG (C) (-60°C) 1.2~1.6	AWS A5.22 E316LT1-1 0.9-1.6	316L 1.2~1.6
SW-316L Cored/M21	TS316L-FB1	E316LT1-4	All		AWS A5.22 E316LT1-4 0.9-1.6	
Supercored 309L/M21		E309LT0-4	Down-hand			SS/CMn 0.9-1.6
Supercored 309MoL/M21		E309LMoT0-4	Down-hand			SS/CMn 0.9-1.6
Supercored 316L/M21		E316LT0-4	Down-hand			316L 0.9-1.6
A-3/S-787TB			F	L3T H10 Max. thick. 28mm (-60°C) 3.2-4.8	5YT H10 Max. thick. 28mm 3.2-4.8	4YT H10 (-60°C) 3.2-4.8
2 X A-3/S-787TB			F		5YT H10 Max. thick. 28mm 3.2-4.8	4YT H10 (-60°C) 3.2-4.8
A-3/Superflux55LP			F		5YT H10 Max. thick. 24mm 3.2-4.8	4YT H10 (-60°C) 3.2-4.8
A-3/Superflux55ULT			F		5YT Max. thick. 1 Wire ≤ 20mm, 2 Wire ≤ 25mm 3.2-4.8	5YT Max. thick. 1 Wire ≤ 20mm, 2 Wire ≤ 25mm 3.2-4.8
H-12K/Superflux787		F7A8-EH12K	F		4YM H5, AWS A5.17 F7A8-EH12K AWS A5.17 F7P8-EH12K 1.2-6.4	
H-14/S-460Y		F8P8-EH14	F	5Y46MH5 1.2-6.4	5YQ460M H5 1.2-6.4	5Y46 H5 1.2-6.4
H-14/S-705EF/IRN/S-22			F	2SMR, 2YSMR 2.0-6.4	2, 2Y 2.0-6.4	2A, 2YA 2.0-6.4
H-14/S-705EF/CW/CBM-G22			F	2SR, 2YSR Max. thick. 25mm 2.0-6.4	2, 2Y 2.0-6.4	2A, 2YA Max. thick. 25mm 2.0-6.4
H-14/S-705EF/CW/SAW-10			F	2YSR 2.0-6.4	2Y 2.0-6.4	
H-14/S-705HF/CW/CBM-G22			F	3Y-SMR Max. thick. 25mm 2.0-6.4	3Y 2.0-6.4	3YA 2.0-6.4
H-14/S-705HF/IRN/BS-3W			F	3Y-SR 2.0-6.4	3Y 2.0-6.4	3YA 2.0-6.4
2 X H-14/S-705HF/IRN/BS-3W			F	3Y-SR 2.0-6.4	3Y 2.0-6.4	3YA 2.0-6.4
H-14/S-707T	S502-H	F7A6-EH14 F7P6-EH14	F	3T, 3YT, 4YM 1.2-6.4	4YM, 3T, 3YT 1.2-6.4	4YM, 3T, 3YT 1.2-6.4
2 X H-14/S-707T	S502-H	F7A6-EH14 F7P6-EH14	F	3T, 3YT, 4YM 1.2-6.4	4YM, 3T, 3YT 1.2-6.4	4YM, 3T, 3YT 1.2-6.4

Register of shipping & size(mm)

BV	DNV	GL	NK	TÜV	DB
UP (KV -120°C) 1.2-1.6	308L (-120°C) 1.2-1.6		KW308LG(C) 1.2-1.6	EN ISO 17633-A T 19 9 L P M21/C1 2	DIN EN ISO 17633-A T 19 9 L P M/C 2
309L with KV at -20°C 1.2-1.6	309L 1.2-1.6	4332S 1.2-1.6	KW309LG(C) 1.2-1.6	EN ISO 17633-A T 23 12 L P M21/C1 2	DIN EN ISO 17633-A T 23 12 L P M/C 2
	309MoL (-20°C) 1.2-1.6	4459S 1.2-1.6	KW309MoLG(C) 1.2-1.6		
	309MoL (-20°C) 1.2-1.6				
316L (-60°C) 1.2-1.6	316L 1.2-1.6	4435S 0.9-1.6	KW316LG(C) 1.2-1.6	EN ISO 17633-A T 19 12 3 L P M21/C1 2	DIN EN ISO 17633-A T 19 12 3 L P M/C 2
				EN ISO 17633-A T 19 12 3 L P M21/C1 2	DIN EN ISO 17633-A T 19 12 3 L P M/C 2
309L 0.9-1.6	309L (-20°C) 0.9-1.6	4332S 0.9-1.6		EN ISO 17633-A T 23 12 L R M21/C1 3	DIN EN ISO 17633-A T 23 12 L R M/C 3
309L Mo 0.9-1.6	309MoL (-20°C) 0.9-1.6	4459S 0.9-1.6			
316L 0.9-1.6	316L (-20°C) 0.9-1.6	4435S 0.9-1.6		EN ISO 17633-A T 19 12 3 L R M21/C1 3	DIN EN ISO 17633-A T 19 12 3 L R M/C 3
A5YT HH thick. 28mm 3.2-4.8	VYT H10 (T:≤28mm) NV4-4L 3.2-4.8		KAWL3TH10 Max. 28mm		DIN EN 760-S A FB1
A5YT HH thick. 28mm 3.2-4.8	VYT H10 (T:≤28mm) NV4-4L 3.2-4.8		KAWL3TH10 Max. 28mm		DIN EN 760-S A FB1
A5YT HH 3.2-4.8	VYT H10 (T:≤24mm) NV4-4L 3.2-4.8	6YT H10 3.2-4.8			
A5YT Max. thick. 1 Wire ≤ 20mm, 2 Wire ≤ 25mm 3.2-4.8	VYT Max. thick. 1 Wire ≤ 20mm, 2 Wire ≤ 25mm Also for NV4-4L 3.2-4.8			EN ISO 14174 - S A FB 1	DIN EN 760-S A FB1
A5Y46M HHH 1.2-6.4	VY46M(H5) 1.2-6.4	6Y46MH5 1.2-6.4	KAW5Y46MH5, KAW63Y47MH5 (-20°C) 1.2-6.4	EN ISO 14171-A S4	DIN EN ISO 14171-A S4
A2M, A2YM 2.0-6.4	IiYM t≤22mm 2.0-6.4	2YM 2.0-6.4	KAW2, KAW52-SMP 2.0-6.4	EN ISO 14171-A S4	DIN EN ISO 14171-A S4
A2M, A2YM 2.0-6.4	IiYM t≤25mm 2.0-6.4	2YM 2.0-6.4	KAW52SP 2.0-6.4	EN ISO 14171-A S4	DIN EN ISO 14171-A S4
	IiY t≤25mm 2.0-6.4	2YM 2.0-6.4	KAW52SP 2.0-6.4	EN ISO 14171-A S4	DIN EN ISO 14171-A S4
A3YM 2.0-6.4	IiiYM t≤25mm 2.0-6.4	3YM 2.0-6.4	KAW53-SMP Max. thick. 25mm 2.0-6.4	EN ISO 14171-A S4	DIN EN ISO 14171-A S4
A3YM 2.0-6.4	IiiYM 2.0-6.4	3Y 2.0-6.4	KAW53SP Max. thick. 25mm 2.0-6.4	EN ISO 14171-A S4	DIN EN ISO 14171-A S4
A3YM 2.0-6.4	IiiYM 2.0-6.4	3Y 2.0-6.4	KAW53SP Max. thick. 30mm 2.0-6.4	EN ISO 14171-A S4	DIN EN ISO 14171-A S4
A4YM, A3T, A3YT 1.2-6.4	IvYM, IiiYT 1.2-6.4	4YM, 3YT 1.2-6.4	KAW53T, KAW54M 1.2-6.4	EN ISO 14171-A S4	DIN EN ISO 14171-A S4
A4YM, A3T, A3YT 1.2-6.4	IvYM, IiiYT 1.2-6.4	4YM, 3YT 1.2-6.4	KAW53T, KAW54M 1.2-6.4	EN ISO 14171-A S4	DIN EN ISO 14171-A S4

SMAW

SAW

GM/AW

GTAW

FCAW

Non-FERROUS

APPENDIX

# Approvals

Classification			Welding Position	Register of shipping & size(mm)		
Brand Name	KS	AWS		KR	ABS	LR
H-14/S-707T/ CW/CBM-G22			F	3YSR Max. thick 28mm 2.0-6.4	3Y Max. thick 28mm 2.0-6.4	3Y Max. thick 28mm 2.0-6.4
H-14/S-707TP	S502-H	F7A6-EH14 F7P6-EH14	F	3M, 3YM 2.0-6.4	3M, 3YM 2.0-6.4	3M, 3YM 2.0-6.4
H-14/S-737	S502-H	F7A4-EH14 F7P4-EH14	F	3M, 3YM 2.0-6.4	3M, 3YM 2.0-6.4	3M, 3YM 2.0-6.4
H-14/S-777MX	S502-H	F7A0-EH14	F	2M, 2YM 1.6-6.4	2M, 2YM 1.6-6.4	2M, 2YM 1.6-6.4
2 X H-14/S-777MX		F7A0-EH14	F		2M, 2YM 1.6-6.4	2M, 2YM 1.6-6.4
H-14/S-777MXH	S502-H	F7A2-EH14 F7P2-EH14	F	2T, 2YT, 3M, 3YM 1.2-6.4	2T, 2YT, 3M, 3YM 1.2-6.4	3M, 3YM, 2T, 2YT 1.2-6.4
2 X H-14/S-777MXH	S502-H	F7A2-EH14 F7P2-EH14	F		3YM 1.2-3.2	3M, 3YM 1.2-3.2
H-14/S-787TB	S502-H	F7A8-EH14 F7P8-EH14	F	3T, 3YT, 4Y40M (-60°C) 1.2-6.4	3T, 3YT, 5Y400M 1.2-6.4	3YT, 5Y40M 1.2-6.4
2 X H-14/S-787TB	S502-H	F7A8-EH14 F7P8-EH14	F		3T, 3YT, 5Y400M 1.2-6.4	3YT, 5Y40M 1.2-6.4
H-14/ Superflux55ULT	S502-H	F7A8-EH14 F7P8-EH14	F	4Y40M H5 (-60°C) 1.2-6.4	5Y400MH5, 4YT 1.2-6.4	4YT, 4Y40M H5 1.2-6.4
2 X H-14/ Superflux55ULT	S502-H	F7A8-EH14 F7P8-EH14	F	4YT 1.2-6.4	5Y400MH5, 4YT 1.2-6.4	4YT, 4Y40M H5 1.2-6.4
H-14/Superflux55ULT/ CW			F		4YM 1.2-6.4	4YM, 4YsrM 1.2-6.4
H-14/Superflux55LP		F7A8-EH14	F		5Y400M H10 1.2-6.4	4Y40M H10 1.2-6.4
H-14/Superflux787	S502-H	F7A8-EH14 F7P8-EH14	F	4YM 1.2-6.4	3M, 4YM 1.6-6.4	3M, 4YM 1.6-6.4
H-14L/Superflux787	S502-H	F7A8-EG-G	F		3M, 4YM 1.6-6.4	
L-8/S-707	S502-H	F7A4-EL8	F	3TM, 3YTM 1.6-6.4	3TM, 3YTM 1.6-6.4	3TM, 3YTM 1.6-6.4
2 X L-8/S-707		F7A4-EL8	F			3TM, 3YTM 1.6-6.4
L-8/S-707/ IRN/S-22			F	2SMR, 2YSMR 2.4-6.4	2, 2Y 2.4-6.4	2A, 2YA 2.4-6.4
L-8/S-707/ CW/CBM-G22			F	2YSR 2.0-6.4	2Y 2.0-6.4	2YA 2.0-6.4
L-8/S-727	S502-H	F7A2-EL8	F	2TM, 2YTM 2.4-6.4	2TM, 2YTM 2.4-6.4	2TM, 2YTM 2.4-6.4
L-12/S-727	S502-H	F7A2-EL12	F		2TM, 2YTM (Two-run tech : Max 5.0mm) 1.6-6.4	2YMH5 1.6-6.4
M-12K/S-717	S502-H	F7A6-EM12K F7P6-EM12K	F	3M, 3YM 2.4-6.4	3M, 3YM 2.4-6.4	3YM 2.4-6.4
YS-2209/ Superflux209			F			
YS-316L/ Superflux300S			F		AWS A5.9 ER316L(Wire) (-60°C) 1.6-5.0	

Register of shipping & size(mm)

BV	DNV	GL	NK	TÜV	DB
A3YU 2.0-6.4	IIIYM T≤28mm 2.0-6.4	3Y 2.0-6.4	KAW53SP Max. thick. 28mm 2.0-6.4	EN ISO 14171-A S4	DIN EN ISO 14171-A S4
A3M, A3YM 2.0-6.4	IIIYM 2.0-6.4	3YM 2.0-6.4	KAW3M, KAW53M 2.0-6.4	EN ISO 14171-A S4	DIN EN ISO 14171-A S4
	IIIYM 2.0-6.4	3YM 2.0-6.4		EN ISO 14171-A S4	DIN EN ISO 14171-A S4
A2M, A2YM 1.6-6.4	IIMY 1.6-6.4	2YM 1.6-6.4	KAW2M, KAW52M 1.6-6.4	EN ISO 14171-A S4	DIN EN ISO 14171-A S4
A2M, A2YM 1.6-6.4	IIMY 1.6-6.4	2YM 1.6-6.4	KAW2M, KAW52M 1.6-6.4	EN ISO 14171-A S4	DIN EN ISO 14171-A S4
A2T, A2YT, A3M, A3YM 1.2-6.4	IHYTH10, IIIYM H10 1.2-6.4	2YT, 3YM 1.2-6.4	KAW3M, KAW53M KAW2T, KAW52T 1.2-6.4	EN ISO 14171-A S4	DIN EN ISO 14171-A S4
A3YM 1.2-3.2		3YM 1.2-3.2		EN ISO 14171-A S4	DIN EN ISO 14171-A S4
A5Y40M, A3T, A3YT 1.2-6.4	VY40M H10, NV4-4L IIYT (35t), VYT (20t) 1.2-5.0	6Y40M, 3YT 1.2-6.4	KAWL3TM, KAW54Y40M 1.2-6.4	EN ISO 14171-A S4	DIN EN ISO 14171-A S4 DIN EN 760-S A FB1
	VY40M H10, NV4-4L IIYT (35t), VYT (20t) 1.2-5.0	6Y40M, 3YT 1.2-6.4		EN ISO 14171-A S4	DIN EN ISO 14171-A S4 DIN EN 760-S A FB1
A5Y40M HHH, A4YT 1.2-6.4	VY40MH5, IVYT, VYT (Tt≤20mm) 1.2-6.4	6Y40H5M, 4YT 1.2-6.4	KAW54T, KAW54Y40MH5 (-60°C) 1.2-6.4	EN ISO 14171-A S4	DIN EN ISO 14171-A S4
A5Y40M HHH, A4YT 1.2-6.4	VY40MH5, IVYT, VYT (Tt≤25mm) 1.2-6.4	6Y40H5M, 4YT 1.2-6.4	KAW54T, KAW54Y40M (-60°C) 1.2-6.4	EN ISO 14171-A S4	DIN EN ISO 14171-A S4
A4YM 1.2-6.4	IVYM 1.2-6.4	4YM 1.2-6.4		EN ISO 14171-A S4	DIN EN ISO 14171-A S4
A5Y40M HH 1.2-6.4	VY40M H10 NV4-4L 1.2-6.4	6Y40M H10 1.2-6.4		EN ISO 14171-A S4	DIN EN ISO 14171-A S4
A4YM 1.2-6.4	IVYM 1.6-6.4	4YM 1.2-6.4	KAW54M 1.2-6.4	EN ISO 14171-A S4	DIN EN ISO 14171-A S4
				EN ISO 14171-A S4	DIN EN ISO 14171-A S4
A3TM, A3YTM 2.4-6.4	IIITM 2.4-6.4	3YTM 2.4-6.4	KAW3TM, KAW53TM 2.4-6.4		
A2M, A2YM 2.4-6.4	IIMY 2.4-6.4	2YM 2.4-6.4	KAW2M, KAW52M 2.4-6.4		
A2YU 2.0-6.4	IIMY 2.0-6.4	2YM 2.0-6.4	KAW52SP 2.0-6.4		
A2TM, A2YTM 2.4-6.4	IIITM 2.4-6.4	2YTM 2.4-6.4	KAW2TM, KAW52TM 2.4-6.4		
A3, A3YM 2.0-6.4	IIIYM 2.0-6.4	3YM 2.0-6.4	KAW53M 2.0-6.4	EN ISO 14171-A S2Si EN ISO 14174 - S A AB 1	DIN EN ISO 14171-A S2Si DIN EN 760-S A AB1
	Duplex Stainless Steel 2.4-3.2				
UP (KV -60°C) 1.6-5.0					

SMAW

SAW

GMAW

GTAW

FCAW

Non-FERROUS

APPENDIX

# Recommendation on HYUNDAI WELDING consumable

## 1 Flux cored wire

Mild and high tensile steel	Minimum yield strength	50kgf/mm <sup>2</sup> (490N/mm <sup>2</sup> )	SF-71, SF-71LF, SC-71LH, Supercored 71, Supercored, 71H, SC-71Ni2, SF-71MC, Supercored 71MAG, SF-70MX, Supercored 70MXH
		60kgf/mm <sup>2</sup> (590N/mm <sup>2</sup> )	Supercored 81, Supercored 81MAG, SC-EG2, Supercored 81K2, Supercored 81K2MAG, SC-81LT, SC-81Ni2, SC-81Ni2M, SC-460, SC-91K2, SC-91LT
		80kgf/mm <sup>2</sup> (790N/mm <sup>2</sup> )	Supercored 110, Supercored 120
Heat resisting and molten Steel	Chemical composition requirement for base metal	0.5Mo	SC-80D2, SC-81A1
		0.5Mo-1.25Cr	Supercored 1CM, SC-81B2
		1.0Mo-2.25Cr	SC-91B3
For low temperature steels	Temperature requirement (°C)	-30°C Charpy-V	Supercored 81, Supercored 71MAG, SC-71LHM, Supercored 70NS
		-40°C Charpy-V	SC-71HJ, Supercored 70B(basic), Supercored 81-K2, SC-81LT
		-60°C Charpy-V	SC-71Ni2, SC-81Ni2, SC-81Ni2M, Supercored 81MAG, Supercored 81-K2MAG
Weather resistant steel	Tensile strength requirement	50kgf/mm <sup>2</sup> (490N/mm <sup>2</sup> )	SF-70W
		60kgf/mm <sup>2</sup> (590N/mm <sup>2</sup> )	SF-80W
Seamless	Temperature requirement (°C)	-20°C Charpy-V	SL-71LH
		-40°C Charpy-V	SL-81LT
		-60°C Charpy-V	SL-71Ni2, SL-81Ni2, SL-81Ni2M

Above stated are just lists of reference, please ask the detail to our institute of technology.



## 2 Covered electrode

Mild steel and high tensile steel	Needed tensile strength at minimum	40kgf/mm <sup>2</sup> (390N/mm <sup>2</sup> )	S-4301.I, S-4303.V, S-6010.D, S-6011.D, S-4303.T, S-6013.LF, S-6013.V, S-7014.F, S-6027.LF
		50kgf/mm <sup>2</sup> (490N/mm <sup>2</sup> )	S-7016.H, S-7016.HR, S-7016.LF, S-7016.M, S-7016.G, S-7016.O, S-7016.LS, S-76LTH, S-7018.G, S-7018.1, S-7018.1H, S-7028.F, S-7014.F, S-7024.F, S-7028.F, S-7048.V
		60kgf/mm <sup>2</sup> (590N/mm <sup>2</sup> )	S-8016.G, S-9016.G, S-8018.G, S-9018.M
		70kgf/mm <sup>2</sup> (690N/mm <sup>2</sup> )	S-10016.G, S-10018.D2
		75kgf/mm <sup>2</sup> (740N/mm <sup>2</sup> )	S-11016.G, S-11018.M
Steel sheet for high resistance and high temperature	Chemical composition of needed basic material	0.5Mo	S7010.A1, S-7016.A1, S-7018.A1
		0.5Cr-0.5Mo	S-8016.B1
		1.25Cr-0.5Mo	S-8016.B2, S-8018.B2, S-8018.B2R
		0.5Cr-1.0Mo	S-8016.B5
		2.25Cr-1.0Mo	S-9016.B3, S-9018.B3, S-9018.B3R
		5.0Cr-0.5Mo	S-8016.B6
		9.0Cr-1.0Mo	S-9015.B9, S-9016.B9
Steel sheet at low temperature	Needed temperature (°C)	-45°C Charpy-V	S-7018.1, S-7018.1H, S-8016.C3, S-8018.C3
		-51°C Charpy-V	S-9018.M, S-11018.M
		-60°C Charpy-V	S-7016.LS, S-76LTH, S-8016.C1, S-8016.C2, S-8018.C1
Weather resistant steel	Needed tensile strength	50kgf/mm <sup>2</sup> (490N/mm <sup>2</sup> )	S-7018.W
		60kgf/mm <sup>2</sup> (590N/mm <sup>2</sup> )	S-8018.W
Hard-facing steel	Needed diameter	Brinell hardness(H.B) 240	S-240A.R, S-260A.B, S-13MN.B
		Brinell hardness(H.B) 350	S-350A.R, S-350B.B
		Brinell hardness(H.B) 400	S-450B.B
		Brinell hardness(H.B) 500	S-500B.B
		Brinell hardness(H.B) 600	S-600B.B
		Brinell hardness(H.B) 700	S-700B.B, S-711
Alloy steel	For cast iron	Ni type	S-NCl, S-NFC
		Fe type	S-FCF
	Steel for 9%Ni	ENiCrFe-4 type	SR-134
	Special alloy	Ni alloy type	SR-182, SR-133, SR-625

Above stated are just lists of reference, please ask the detail to our institute of technology.

# Recommendation on HYUNDAI WELDING consumable

## 3 Saw wire and flux

Mild steel and high tensile steel	Minimum yield strength	50kgf/mm <sup>2</sup> (490N/mm <sup>2</sup> )	S-707 X L-8, S-707T X H-14, S-717 X M-12K, S-727 X L-8, S-777MX X H-14, S-705EF X H-14, Superflux787 X H-14 (H-12K), Superflux55ULT X H-14
		60kgf/mm <sup>2</sup> (590N/mm <sup>2</sup> )	S-777MXH X A-3, S-800MX X A-3, S-800SP X A-2, Superflux600 X A-3, S-460Y X H-14
	Needed temperature (°C)	-18°C Charpy-V	S-777MXT X H-14
		-29°C Charpy-V	S-727 X L-8, S-777MXH X H-14
		-40°C Charpy-V	S-800SP X M-12K, S-900SP X M-12K, S-707 X L-8
		-51°C Charpy-V	S-717 X M-12K, S-707T X H-14, Superflux600 X H-14
		-62°C Charpy-V	Superflux800T X M-12K, S-800WT X M-12K, S-787TT X H-14 (H-12K), S-787TB X H-14, Superflux787 X H-14 (H-12K), S-460Y X H-14, Superflux55ULT X H-14

Above stated are just lists of reference, please ask the detail to our institute of technology.

## 1 Automotive

Hyundai Welding material advantages, features and development for automotive industry

- Production and supply of products to comply with customer's environments and application
- Excellent wire feeding for automated robotic welding and premium solid wire for maximizing welding performance
- Development of high quality wire for GA grade steel to get the excellent porosity performance and low slag generation.

### 1) Featured products

Chassis frames	SM-70	MIG/MAG wire
	SM-70S	MIG/MAG wire
	SC-70Z	Metal cored wire(GA steel)
Exhaust pipe	SW-309LNS Cored	Metal cored wire(Stainless steel)
	SF-409Ti	Metal cored wire(Stainless steel)

### 2) Other products

Stick electrodes	
Flux cored wire	SF-430Nb
Metal cored wire	SF-430, SF-436, SC-439Ti Cored
SAW Wire & Flux	
MIG/MAG wire	SM-430LNb, SM-70EN
TIG wire	ST-430LNb
Ni-Alloy	
Others	

# Industries

## 2 Heavy Equipment

Hyundai Welding material advantages, features and development for heavy equipment industry

- Premium quality assurance designed for high ampere automatic welding
- Maximize productivity with developed PAK feeding system
- Wide range of wires in accordance with the recent trend of high tensile strength steel

### 1) Featured products

Construction equipment	SM-70G	MIG/MAG wire
	SM-70EN	MIG/MAG wire
	SM-80G	MIG/MAG wire
Industrial equipment	SM-100	MIG/MAG wire
	SM-110	MIG/MAG wire

### 2) Other products

Stick electrodes	
Flux cored wire	Supercored 70NS
Metal cored wire	SC-70ML, SC-80CM, SC-90M
SAW Wire & Flux	
MIG/MAG wire	SM-70, SM-70G, SM-70GS, SM-55H, SM-80G
TIG wire	
Ni-Alloy	
Others	

### 3) Equipment

Featured products	HD AUTO+ SERIES
Other products	HIEGW SERIES

### 3 Shipbuilding

Hyundai Welding material advantages, features and development for shipbuilding industry

- Good performance and less spatter in all position welding with stable arc
- Excellent crack and defective resistance in extreme situation and construction.
- Eco-friendly Low Fume material development to meet customer requirement

#### 1) Featured products

Chemical tankers	SW-316L Cored	Flux cored wire(Stainless steel)
	SW-309MoL Cored	Flux cored wire(Stainless steel)
LPG Tankers	Supercored 81-K2	Flux cored wire
	SC-80K2	Semi-metal cored wire
	SC-71Ni2	Flux cored wire
Container vessels	SF-71	Flux cored wire
	SC-71LH	Flux cored wire
	SF-70MX	Semi-metal cored wire
	Supercored 71	Flux cored wire

#### 2) Other products

Stick electrodes	S-7018.1H, S-76LTH, S-308L.16N, S-316L.16N, S-7016.H, S-7016.HR, S-7016.LS, S-7018.1, S-7018.G, S-7018.GH, S-309L.16, S-309MoL.16, S-317L.16
Flux cored wire	SC-71HJ
Metal cored wire	Supercored 71H, Supercored 71MAG, SC-71MJ, SC-71SR, SC-71MSR, SF-71MC, SC-71LHM, Supercored 70MXH, SF-80MX, SC-91K2, Supercored 110, Supercored 81K2MAG, Supercored 70NS, SC-70ML, SC-80M, SC-90M, SC-110M
SAW Wire & Flux	Superflux55ULT × H-14, S-707 × L-8, S-707T × H-14, S-787TB × H-14, S-705EF × H-14, S-705HF × H-14, S-460Y × H-14
MIG/MAG wire	SM-70, SM-70G, SM-308L, SM-309L, SM-316L
TIG wire	ST-50.3, ST-50.6, ST-1N, ST-308L, ST-309L, ST-316L
Ni-Alloy	
Others	

#### 3) Equipment

Featured products	HD AUTO+ SERIES
Other products	PONY SERIES, PHANTOM SERIES, LIBERO 600M, BETA SERIES, ALPHA SERIES, HIEGW SYSTEM, NEO SAW SERIES

# Industries

## 4 Offshore structures

Hyundai Welding material advantages, features and development for Offshore structures industry

- High impact toughness at cryogenic(-196°C) and CTOD toughness
- Diffusible hydrogen level control and cracking improvement by Seamless wire

### 1) Featured products

Offshore platform Jack up Rig Drillship Submersible LNG Vessels & FPSO	ST-1N	TIG wire
	SMT-625	MIG/TIG wire
	YS-2209 & Superflux209	SAW Wire & Flux(Duplex)
	SW-625	Flux cored wire(Ni- alloy)
	Supercored 81-K2	Flux cored wire
	SC-81LT	Flux cored wire
	SC-81Ni2	Flux cored wire
	SC-81Ni2M	Flux cored wire
	SL-81LT	Seamelss Flux cored wire
	SL-81Ni2	Seamelss Flux cored wire
SL-81Ni2M	Seamelss Flux cored wire	

### 2) Other products

Stick electrodes	S-7018.1H, S-76LTH, S-308LT.16, S-316LT.16, S-7018.1, S-7016.LS, S-8016.C1, S-8016.C2, S-8016.C3, S-308L.16N, S-309L.16, S-316L.16N, S-309MoL.16, S-317L.16
Metal cored wire	SC-70ML, Supercored 70NS, SC-80M, SC-90M, SC-110M
SAW Wire & Flux	Superflux55ULT × H-14, Superflux787 × H-14, S-460Y × H-14
MIG/MAG wire	SM-80G, SM-80CM, SM-100, SM-110
TIG wire	ST-50.6, ST-50G, ST-80B2, ST-308L, ST-309L, ST-316L
Ni-Alloy	SMT-686
Others	

### 3) Equipment

Featured products	HD AUTO+ SERIES
Other products	PONY SERIES, PHANTOM SERIES, ZEUS SERIES, HERA SERIES, LIBERO 600M, NEO SAW SERIES

## 5 Energy & Power Plants

Hyundai Welding material advantages, features and development for energy and power plant

- Development of heat resistance consumables designed for various heat treatment
- Improvement for crack resistance by controlling of X-Factor, diffusible hydrogen content

### 1) Featured products

Thermal & Hydroelectric generation	B-2 & S-800CM	SAW Wire & Flux
	ST-91B9	TIG Wire
	S-9018.B3R	Stick electrodes
Wind power	M-12K & Superflux800T	SAW Wire & Flux
	M-12K & S-717	SAW Wire & Flux
	Supercored 81-K2MAG	Flux cored wire
Nuclear Power	SF-71MSR	Flux cored wire
	S-7016.H	Stick electrodes
	S-308L.16	Stick electrodes(Stainless steel)
Other alternative power	H-12K & Superflux787	SAW Wire & Flux
	SC-80D2	Metal cored wire
Petro-Chemical plants	YSB-309LNb & S-300EM	SAW wire & flux(Stainless steel)
	SA-625 & Superflux300	SAW wire & flux(Ni-alloy)
	SR-625	Stick electrodes(Ni-alloy)
LNG storage Tank	S-Ni-2 & SA-08	SAW wire & flux(Ni-alloy)
	SR-134	Stick electrodes(Ni-alloy)
	SR-08	Stick electrodes(Ni-alloy)

### 2) Other products

Stick electrodes	S-8018.B2R, S-9018.B3R, S-9015.B92, S-9016.B92, S-9015.B9, S-308L.16N, S-309L.16, S-316L.16N, S-347.16, S-8018.G, S-9016.G, S-10016.G, S-11016.G, S-9018.M, S-11018.M, S-7016.A1, S-7018.A1, S-8016.B1, S-8016.B2, S-8018.B2, S-9016.B3, S-9018.B3, S-8016.B5, S-310.16, S-310.15, S-309MoL.16, S-312.16, S-317L.16, S-7018.W, S-8018.W
Flux cored wire	SC-81A1
Metal cored wire	SC-81B2, SC-91B3, Supercored 70NS, SC-70ML, Supershield EG-72T, Supershield EG-82T
SAW Wire & Flux	Superflux800T × M-12K, S-800WT × M-12K, S-717 × M-12K, S-800CM × B-2, S-777MXT × A-2(B-2), S-787TB × H-14
MIG/MAG wire	SM-70G, SM80G, SM-100, SM-109, SM-110, SM-80CM, SMT-625, SM-316L
TIG wire	ST-308L, ST-309L, ST-316L, ST-80B2
Ni-Alloy	SA-08 × S-Ni2
Others	Superflux300S × YS-308L, Superflux300S × YS-309L, Superflux300S × YS-316L

### 3) Equipment

Featured products	PONY SERIES, HD AUTO+ SERIES
Other products	ZEUS SERIES, HERA SERIES, BETA SERIES, LIBERO 600M, PHANTOM SERIES, ALPHA SERIES

# Industries

## 6 Steel Fabrication

Hyundai Welding material advantages, features and development for steel fabrication

- Good performance and less spatter in all position welding with stable arc
- Excellent anti-porosity against rusty and primed plate
- Excellent crack-resistance for high tensile TMCP plate
- Development products of different processes due to high strength trend

### 1) Featured products

General steel structure	SF-70MX	Semi-metal cored wire
	SF-71	Flux cored wire
High tensile steel structure	SC-91	Flux cored wire
	SC-91K2 Cored	Flux cored wire
	SM-100	MIG/MAG wire
	SC-110M Cored	Flux cored wire

### 2) Other products

Stick electrodes	S-6013.LF, S-7016.H, S-7016.HR, S-7018.G, S-7024.F, S-7018.1H, S-7018.1, S-308L.16N, S-309L.16, S-316L.16N, S-4301.I, S-4303.V, S-4303.T, S-6010.D, S-6011.D, S-6013.V, S-6027.LF, S-7014.F, S-7018.GH, S-7028.F, S-7048.V, S-8016.G, S-8018.G, S-9016.G, S-10016.G, S-11016.G, S-9018.M, S-11018.M, S-7018.W, S-8018.W, S-308Mo.16, S-309MoL.16, S-312.16, S-317.16
Flux cored wire	Supercored 70NS
Metal cored wire	SC-70ML, SC-70T Cored, SC-80D2, Supershield 11, SC-80M, SC-90M, SC-55 Cored, SC-55F Cored, Supercored 81, SC-91, SC-90, SC-81K2, SC-91K2, SC-80CM, SC-90M
SAW Wire & Flux	Superflux600 × H-14(A-3), S-777MX × H-14, S-777MXH × H-14(A-3), S-777MXT × H-14
MIG/MAG wire	SM-70, SM-70G, SM-70S, SM-70EN, SM-70GS, SM-55H, SM-80G, SM-80CM, SM-100, SM-110, SM-55H, SM-80G, SM-80CM, SM-100, SM-110
TIG wire	
Ni-Alloy	
Others	

### 3) Equipment

Featured products	PONY SERIES, HD AUTO+ SERIES
Other products	PONY SERIES, PHANTOM SERIES, ZEUS SERIES, HERA SERIES, HYPLA SERIES



## 7 Pipe industry

Hyundai Welding material advantages, features and development for pipe industry

- Strength moisture-proof with the control of hydrogen content and vacuum packing
- Development of pipe welding material to satisfy customer's requirement
- High product quality in accordance with customer's reference

### 1) Featured products

Pipe mill	A-2 & S-800SP	SAW wire & Flux
	M-12K & S-800SP	SAW wire & Flux
	A-2 & S-900SP	SAW wire & Flux
	M-12K & S-900SP	SAW wire & Flux
Pipeline installation	SC-71MSR	Flux cored wire
	Supercored 81MAG	Flux cored wire
	SC-91P	Flux cored wire

### 2) Other products

Stick electrodes	S-6010.D, S-6011.D, S-7016.O, S-308L.16N, S-309L.16, S-316L.16N, S-347.16
Flux cored wire	SF-71MC
Metal cored wire	SC-71SR, SC-70T Cored
SAW Wire & Flux	Superflux787 × H-12K, S-777MX × H-14, S-777MXT × H-14, S-800SP × M-12K(A-2), S-900SP × M-12K(A-2), S-787TT × H-14(H-12K), S-787TB × H-14
MIG/MAG wire	SM-80CM, SM-308L, SM-309L, SM-316L
TIG wire	ST-80B2, ST-308L, ST-309L, ST-316L
Ni-Alloy	
Others	

### 3) Equipment

Featured products	HD AUTO+ 600P, PIPEMATIC SYSTEM
Other products	LIBERO 600M

# Industries

## 8 Process industry

Hyundai Welding material advantages, features and development for process industry

- Quality assurance through applying inactive flux
- Excellent mechanical properties in weld metal under the condition of various heat treatment environments

### 1) Featured products

Food & Beverage	Supershield CrC	Flux cored wire
	Supershield CrCNb	Flux cored wire
Pressure vessels	H-12K & Superflux787	SAW wire & flux
	M-12K & S-717	SAW wire & flux
	H-14 & S-777MX	SAW wire & flux
	SC-81B2	Flux cored wire
	SC-91B3	Flux cored wire
	SC-91B9	Flux cored wire
	SC-80D2	Metal cored wire
	Supercored 1CM	Flux cored wire

### 2) Other products

Stick electrodes	
Flux cored wire	
Metal cored wire	
SAW Wire & Flux	
MIG/MAG wire	SM-55H, SM-80G, SM-100, SM-110
TIG wire	ST-50G, ST-50.6, ST-50.3, ST-80.B2, ST-50G, ST-50.6, ST-50.3, ST-80.B2
Ni-Alloy	
Others	

### 3) Equipment

Featured products	
Other products	BETA SERIES, ALPHA SERIES

## 9 Repair & Maintenance

Hyundai Welding material advantages, features and development for repair & maintenance industry

- Maximize wear resistance and impact resistance by forming compound carbide
- Providing high temperature wear resistance specially designed for continuous casting rolls
- Providing different kinds of welding material with Open-Arc, SAW, Gas Shield, etc method.

### 1) Featured products

Continuous casting rolls	SC-414S	Flux cored wire
	SC-423S	Flux cored wire
	SC-420S	Flux cored wire
	S-717	SAW flux
	S-400HF	SAW flux
Mining & other equipment	Supershield CRC	Flux cored wire
	Supershield CRCW	Flux cored wire
	SC-600HM	Flux cored wire

### 2) Other products

Stick electrodes	
Flux cored wire	Supershield 430-0
Metal cored wire	Supershield 410NiMo-0
SAW Wire & Flux	
MIG/MAG wire	
TIG wire	
Ni-Alloy	
Others	

### 3) Equipment

Featured products	
Other products	HIEGW SERIES

# HYUNDAI BALL PAC

FCW/Solid Wire

HYUNDAI BALL PAC is a new and improved version of our original Pail Pack. Our patented 'marble' system, acts as a 'non-static' resistance on top of the wire, The marbles add weight on the wire to ensure that only one strand, at a time, is picked up. With the shape and weight of the 'marbles', the wire pulls up and out of the Ball Pac consistently and without the normal static resistance found with other systems. Our wire is pulled out with minimum resistance and seamless feedability is the end result.

Hyundai hard wires are 'pre-tensioned' before being put into the Ball Pac. Meaning, our wire has little to no cast and helix when coming out of the Ball Pac and the 'straightness' of the wire will give more accurate and consistent starts and weld tracking. This is most ideal for robotic applications. As the wire has no cast, you can decrease the tip diameter by one size ("Except in the case of .052"). This will ensure that the wire is in constant contact with the tip (better current transfer) and will increase the accuracy of the weld.

Another major factor in the quality and consistency of Hyundai hard wire is the method of coppercoating the wire. Hyundai Welding is one of the few companies in the world, who are currently using the Electronic Coating process. With this State-of-the-Art coating process, the user will experience the following benefits

- 1) Better Feedability : due to the 'even' coating of copper, feedability is more consistent. Resulting in lower feed resistance.
- 2) Copper Flaking : since wire is coated electronically, the adherence of the copper on the wire is 100% as the coating is evenly applied thus, rendering 'copper-flaking' obsolete. No more clogged or damaged liners.
- 3) Current Transfer : the current transfer will be more consistent due to the 'evenness' of the copper coating
- 4) Less Fume : with the even and consistent copper coating, there are less fumes than conventional chemically-coated wires on the market today.

## 1 Characteristics of Product

- 1) Excellent feeding.  
Minimizing friction as it possesses a device developed for the prevention of twisted and tangled wire, thus, resulting in a smooth feeding action and stable arc, which facilitates welding.
- 2) Makes good tracking on a welding seam.  
Wire is set to be elastically twisted in the pail, so wire is pulled out straight, without rotation of the pail.

3) Improved welding efficiency.

The large-packaged wire can save time in change wire, which is effective, particularly, for robotic and other automatic welding.

4) Pressure device system, deformation in “stacked” state with anti-tangling pressure device system, deformation of the wound wire is greatly minimized or, as in most cases, has now become obsolete.

**2 Type of Product**

Packing Weight	Classification	Solid Wire/FCW
50kg(110lbs), 100kg(220lbs) 150kg(330lbs), 200kg(440lbs) 250kg(551lbs), 300kg(661lbs) 350kg(772lbs), 400kg(882lbs) 420kg(926lbs), 500kg(1,102lbs)		0.9ø(.035in), 1.0ø(.039in) 1.2ø(.045in), 1.4ø(.052in) 1.6ø(1/16in)

**3 Size of Feeder**

Classification		Drum	510 Type	660 Type
CAP	Outer dia. mm(in)		510(20.1)	660(26)
	Height mm(in)		300(11.8)	500(19.7)
FLEXIBLE CABLE	Outer dia. mm(in)		11(0.43)	11(0.43)
	Length(m)		1,2,3,4,5	1,2,3,4,5
CABLE FIXER			FLEXIBLE CABLE FIXING	

**4 Caution**

- 1) Keep in dry and moisture-free location.
- 2) Move on a pallet when moving individually, keep it standing up right, using the ring attached to container with the lid closed.
- 3) Severe impact can deform wire shape and cause poor feeding.
- 4) Laying down or tilting can entangle wire in container, which hinders usage.
- 5) Flexible cable needs periodic cleaning.
- 6) Make sure you use all the balls found inside.
- 7) Do not spill the glass balls on the floor to prevent from falling down.

SMAW  
 SAW  
 GMAW  
 GTAW  
 FCAW  
 Non-FERROUS  
 APPENDIX

# PAK Series



HYUNDAI BALL PAC is a new and improved version of our original Pail pack. Our patented 'marble' system, acts as a 'non-static' resistance on top of the wire. The marble add weight on the wire to ensure that only one strand, at a time, is picked up. With the shape and weight of the 'marbles', the wire pulls up and out of the Ball Pac consistently and without the normal static resistance found with other drum systems. Our wire is pulled out with minimum resistance and seamless feedability is the end result.



Easy to check the remaining wire as no drum is installed inside the pak. Designed as a pressing plate by step method which minimizes the wire feeding resistance, also adopted a practical design to prevent tangling during wire feeding. Likewise by removing the drum and using a light-weighted pressing plate, the light weighted pak could be launched. Therefore it is easy to carry and handle. It will be more likely to find out its convenience with advantages as this item made the best use of our ball pak type, which our company feels proud of.



The newly developed RING PAK can effectively prevent wire from any tangling in spite of insufficient winding quality. In a feedability comparison test with previous models, it shows predominant feedability and weldability. As a result of minimized resistance in feedings, it guarantees Superior feedability, Excellent seam tracking, consistent penetration and the straight in bead appearance.

## Product Packing Type

S : Solid Wires F : Flux Cored Wires

Type		Type Unit Weight(kg)										
		50	100	150	200	250	300	350	400	420	500	
Dia. (mm)	0.9	S/F	S/F	S/F	S/F	S/F	S/F	S/F	S/F	S/F	S/F	S/F
	1.0	S/F	S/F	S/F	S/F	S/F	S/F	S/F	S/F	S/F	S/F	S/F
	1.2	S/F	S/F	S/F	S/F	S/F	S/F	S/F	S/F	S/F	S/F	S/F
	1.4	S/F	S/F	S/F	S/F	S/F	S/F	S/F	S/F	S/F	S/F	S/F
	1.6	S/F	S/F	S/F	S/F	S/F	S/F	S/F	S/F	S/F	S/F	S/F



PATENT No.

US5746380 (U.S.A)  
 AU681988 (AUSTRALIA)  
 138931 (KOREA)  
 3040923 (JAPAN)  
 ZL962185353 (CHINA)

UTILITY MODEL No.

# HOW TO USE

## USE

### IMPORTANT

- Use **all** the balls packed inside.
- Only use the balls for their intended purpose.
- Do not put balls in mouth or roll them on the floor.
- Be careful not to drop balls on the floor, serious injuries can result.

• Before use – When installing

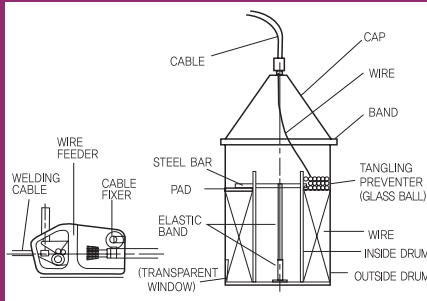

## CAUTION

1. STORAGE
2. TRANSFER
3. USE CAP
4. CABLE ESTABLISH
5. CLEANING

### ② TRANSFER



### ① STORAGE

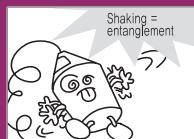

### ③ USE CAP

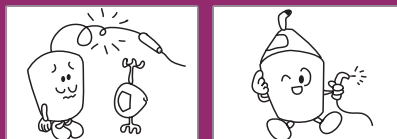

### ④ CABLE ESTABLISH



### ⑤ CLEANING



❖ CUSTOMER SERVICE TEL. : SEOUL (82-2)6230-6051~62

SMAW  
 SAW  
 GMAW  
 GTAW  
 FCAW  
 Non-FERROUS  
 APPENDIX



# HOW TO USE

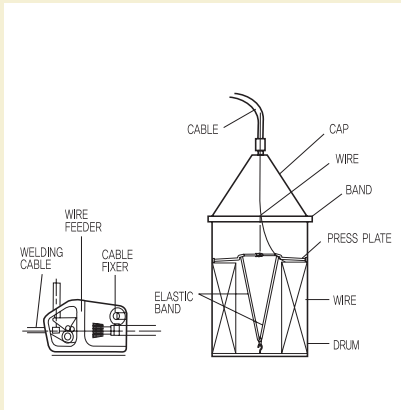

## USE

• Before use – When installing

1. Open the lid
2. First, remove elastic band,
3. Pull lead wire
4. Raise the cap on the top of roll and tighten it with band,
5. Connect one end of the cable with the wire-feeder. Then connect wire with the wire leader horizontally.
6. and tighten the other end on the cap
7. Loosen the wire in MAX PAK and connect the wire end with the wire leader THEN USE.

## CAUTION

1. STORAGE
2. TRANSFER
3. USE CAP
4. CABLE ESTABLISH
5. CLEANING

### ② TRANSFER

entanglement



### ① STORAGE



### ③ USE CAP



### ④ CABLE ESTABLISH



### ⑤ CLEANING



❖ CUSTOMER SERVICE TEL. : SEOUL (82-2)6230-6051~62





**USE**

# HOW TO USE

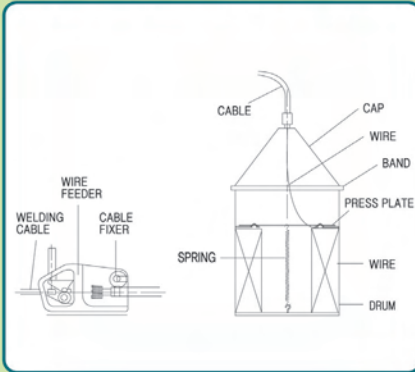

• Before use – When installing



- CAUTION**
1. STORAGE
  2. TRANSFER
  3. USE CAP
  4. CABLE ESTABLISH
  5. CLEANING

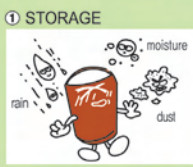

❖CUSTOMER SERVICE TEL. : SEOUL (82-2) 6230-6051~62

# HYUNDAI Standard Packing

## 1 Covered Electrodes

### 1) For Carbon Steels, High Tensile Steels, Low Alloy Steels, Hardfacing

5kg packet (4EA) / 20kg carton (50EA) / 1,000kg wooden pallet

**Standard Size**

5kg                      20kg                      1,000kg

Packet Size(mm)		Carton Size(mm)		Pallet Size(mm)	
a	78	d	82	$l \leq 450$	$l > 450$
b	40~65	e	180~275	A	400      400
c	304~554	f	312~562	B	130, 160    130, 160
				C	1,150      1,130
				D	930        980

$l$  = Electrode length

### 2) $l > 450$ : S-6027.LF, S-7028.F

10kg Packet (2EA) / 20kg carton (50EA) / 1,000kg wooden Pallet

### 3) For Stainless Steels, Cast Iron & Nickel Based Materials

2.5kg hermetically sealed P.V.C Box (4EA) / 10kg carton (90EA) / 900kg wooden pallet

**Hermetically sealed P.V.C Box**

2.5kg                      10kg                      900kg

Packet Size(mm)			Carton Size(mm)			Pallet Size(mm)		
$l$	300mm	350mm	$l$	300mm	350mm	$l$	300mm	350mm
a	79	73	d	86	80	A	860	800
b	79	73	e	335	310	B	130,160	130,160
c	340	390	f	360	410	C	1,070	1,210
						D	1,010	950

$l$  = Electrode length

#### 4) Vaccum packing

1.5kg aluminum vaccum packet (10EA) / 15kg Corton Box

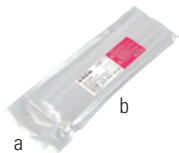

1.5kg packet Size(mm)			
l	350mm	400mm	450mm
a	150	150	150
b	450	500	550

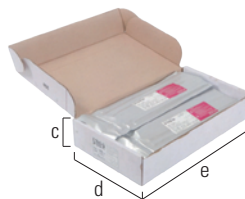

15kg carton Size(mm)			
l	350mm	400mm	450mm
c	142	142	142
d	175	175	175
e	420	470	520

#### 2 TIG Wire

5kg PVC tube (200EA) / 1,000kg wooden Pallet

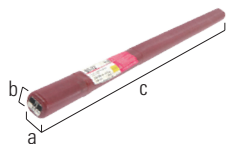

Tube Size(mm)	
a	48
b	31
c	1,010

Pallet Size(mm)	
A	280
B	130, 160
C	1,070
D	1,070

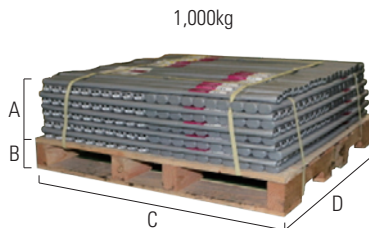

# HYUNDAI Standard Packing

## 3 Compound Flux (for Covered Electrodes, Submerged Arc Fluxes)

500kg / 1,000kg

	Bag Size(mm)	
	500kg	1,000kg
A	600	700
B	800	930
C	800	930
D	210	230
E	160	160
F	400	400

Bag Material: PP Cloth Lami

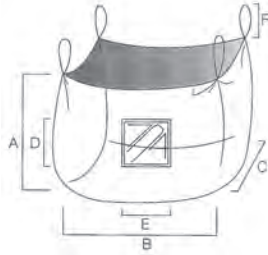

## 4 Spool

### 1) MIG Solid Wire

- (1) 15kg Plastic spool / (60EA) / 900kg wooden Pallet
- (2) 15kg Plastic spool / (72EA) / 1,080kg wooden Pallet
- (3) 20kg Plastic spool / (60EA) / 1,200kg wooden Pallet

### 2) Stainless MIG Wire

12.5kg Plastic spool / (72EA) / 900kg wooden Pallet

### 3) FCW

- (1) 5kg Plastic spool / (200EA) / 1,000kg wooden Pallet

Box Size(mm)	
a	64
b	210
c	215

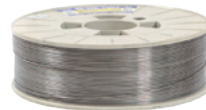
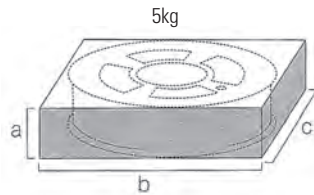

- (2) 12.5kg Plastic spool / (60EA) / 750kg wooden Pallet
- (3) 15kg Plastic spool / (60EA) / 900kg wooden Pallet
- (4) 15kg Plastic spool / (72EA) / 1,080kg wooden Pallet
- (5) 20kg Plastic spool / (60EA) / 1,200kg wooden Pallet

12.5kg / 15kg / 20kg

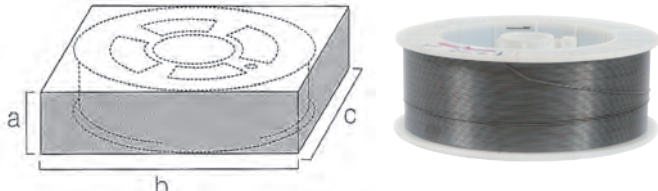

Box Size(mm)	
a	110
b	270-280
c	270-280

900kg / 1,200kg

Pallet Size(mm)			
	12.5kg/20kg spool	15kg spool	5kg spool
A	550	550-660	640
B	130, 160	130, 160	130, 160
C	1,200	1,130	1,130
D	900	850	850



## 5 Pail Pack

### 1) 510 type / wooden pallet

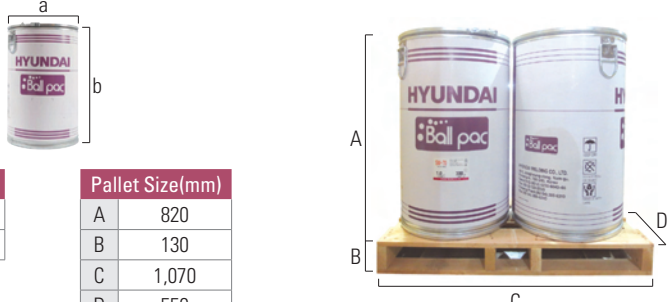

Pac Size(mm)	
a	510
b	810

Pallet Size(mm)	
A	820
B	130
C	1,070
D	550

# HYUNDAI Standard Packing

## 2) 570 type / wooden pallet

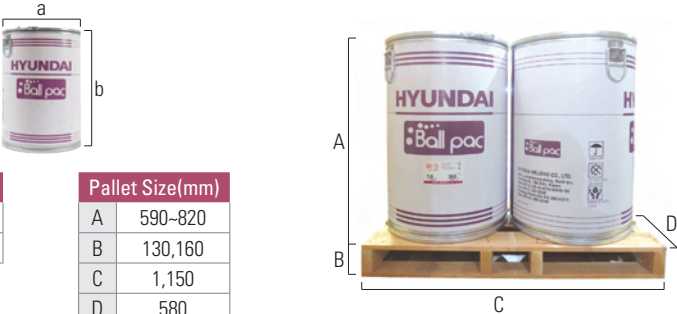

Pac Size(mm)	
a	570
b	575~810

Pallet Size(mm)	
A	590~820
B	130,160
C	1,150
D	580

## 3) 660 type / 350~500kg / wooden pallet

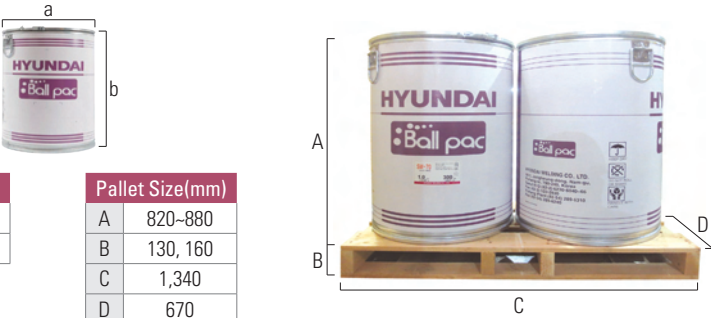

Pac Size(mm)	
a	660
b	810~870

Pallet Size(mm)	
A	820~880
B	130, 160
C	1,340
D	670

## 4) Cap & Cable

Cap & Cable Size(mm)				
	Cap		Cable	
	150-300kg Type	350-420kg Type	150/200/250kg Type	300/350kg Type
A	300	500		
B	510	660		
C			1, 2, 3, 4, 5(m)	1, 2, 3, 4, 5(m)
D			10(mm)	10(mm)

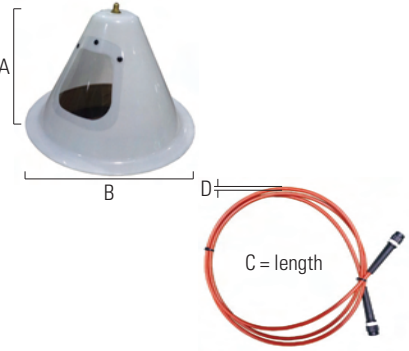

## 6 Submerged Wire & Flux

### 1) Submerged Wire

25kg coil / (48EA) / 1,200kg wooden pallet

Box Size(mm)

a	80
b	430
c	430

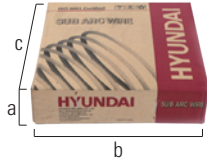

Pallet Size(mm)

A	640
B	130, 160
C	1,320
D	860

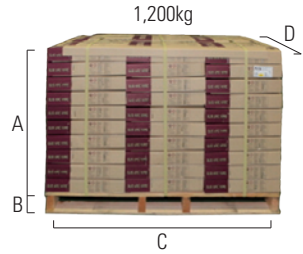

### 2) Submerged Wire Coil

Coil Size(mm)

	A	B	C
25kg	305/315	410/420	75/100
30kg	305	400	95
75kg	630	740	90/100
100kg	630	760	90/100
150kg	630	790	90
300kg	630	820	210
500kg	630	910	210
1,000kg	630	1,140	210

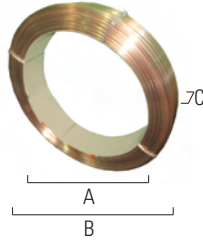

75kg Coil Type



100kg Coil Type



150kg Coil Type



300kg Coil Type



500kg Coil Type



1,000kg Coil Type



# HYUNDAI Standard Packing

## 3) Submerged Wire Coil (25kg Basket packing)

25kg coil / (48EA) / 1,200kg wooden pallet

Box Size(mm)	
a	105
b	430
c	430

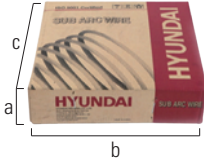

Pallet Size(mm)	
A	840
B	130, 160
C	1,320
D	860

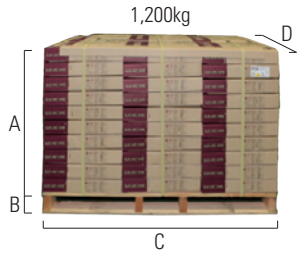

## 4) Submerged Flux

20kg Tin Can / (40EA) / 800kg wooden pallet



Can Size(mm)	
a	375
b	235
c	235

Pallet Size(mm)	
A	750
B	130
C	1,170
D	930



20kg Paper bag (50EA) / 1,000kg wooden pallet

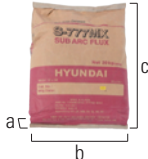

Paper bag Size (mm)	
a	75
b	415
c	650

Pallet Size(mm)	
A	650
B	160
C	1,210
D	970





20kg PE Bag (40EA) / 800kg wooden pallet

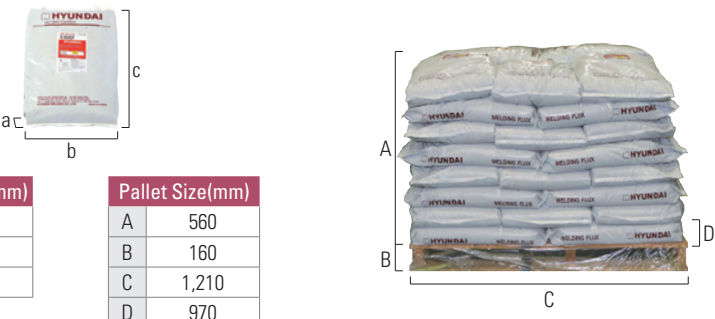

PE bag Size(mm)	
a	70
b	365
c	655

Pallet Size(mm)	
A	560
B	160
C	1,210
D	970

5) Plastic spool

Material	Spool Size(mm)			USAGE
	A	B	C	
HIPS	55	52	199-200	FCW / Solid Wire 5kg
HIPS	72	52	203-204	FCW 6.8 kg
HIPS	100-102	52-53	279-280	FCW 12.5kg
HIPS	100-102	52-53	269-270	FCW 15kg / Solid Wire 15-20kg
HIPS	100-102	52-53	279-280	FCW 20kg

HIPS : HIGH IMPACT POLYSTYREN

Spool Design

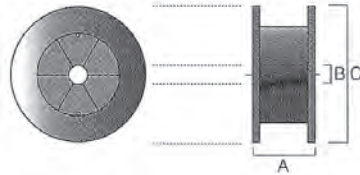

# HYUNDAI Standard Packing

## ※ Basket Spool

Coreless Type

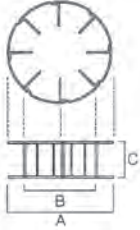

Basket Spool Adaptor

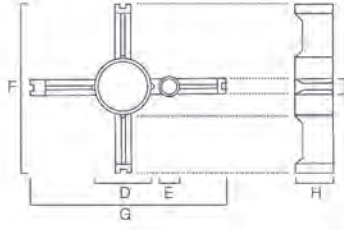

Spool Size(mm)

A	B	C	D	E	F	G	H	I	USAGE
298~300	180~182	98	55	13	180	220	97	18	15kg / Solid wire 15~20kg
413~419	297~303	103	-	-	-	-	-	-	Submerged Wire 25kg

Core Type

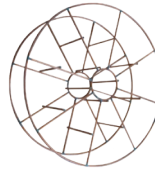
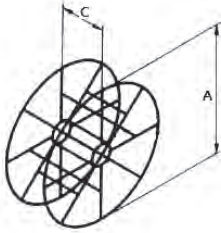

Spool Size(mm)

A	B	C	USAGE
298~300	-	99~100	FCW 15kg / Solid wire 15~20kg

## 7 Length of Wire

Description	Diameter	Weight(kg)	Length(m)
Solid Wire	0.8	20	5,470
	0.9	20	4,285
	1.0	20	3,445
	1.2	20	2,370
	1.4	20	1,730
	1.6	20	1,320
FCW	1.2	15	2,080
	1.4	15	1,520
	1.6	15	1,155
Submerged Wire	2.0	25	1,045
	2.4	25	720
	3.2	25	400
	4.0	25	255
	4.8	25	175
	5.0	25	165
	6.4	25	100

SWAW

SAW

GMAW

GTAW

FCAW

Non-FERROUS

APPENDIX

# Warning for Safety in Welding



## WARNING

- Be sure to follow the safety practices stated in the following in order to protect welders, operators and accompanied workers from a serious accident resulting in injury or death.

- Be sure to follow the safety practices stated in the following when you use welding consumables.
- Be sure to follow the safety practices stated in the instruction manual when you use welding equipment.



## WARNING



- Electric shock can kill.

- Do not touch live electrical parts.(A covered electrode held with an electrode holder and a wire in welding are electrically live.)
- Wear dry, insulated gloves. Do not wear teared and wet gloves.
- Use an electric shock preventing device(open-circuit-voltage-reducing device)when welders or operators work in confined or high-level spaces. Use also a lifeline when a welder or an operator conducts welding at a high-level area.
- Follow the safety practices stated in the instruction of the welding machine before you use. Do not use a welding machine case or cover of which is removed. Welding cables must be a size adequate for the capacity expected. Welding cables must be maintained, and a damaged cable must be repaired or replaced one.



## WARNING



- Fumes and gases generated in welding can be dangerous to your health.
- Welding in confined spaces can be dangerous for suffocation because of oxygen deficient atmospheres.

- Keep your head out of the source of gases to prevent from directly breathing high density fumes or gases.
- Use local exhaust ventilation, or wear respirators in order to prevent you from breathing fumes and toxic gases which cause toxication, poor health and suffocation by oxygen deficient atmospheres.
- Use general ventilation for welding in the workshop. Particularly in welding in confined spaces, be sure to use adequate ventilation, or wear respirators at the presence of a trained supervisor.
- Do not weld where operations of degreasing, cleaning, spraying, and painting are present nearby. Welding work close to these operations may cause a generation of harmful gases.
- Use adequate ventilation or respirators with special attention in welding plated and coated steel.
- Use respirators, eye safety glasses and safety leather gloves when handling welding fluxes in order to prevent you from the flux dust.



## WARNING



- Arc rays can injure eyes and burn skin.

- Wear hand shields with an adequate grade of shade in welding and supervising the welding work.
- Select the correct grade shade for filter lenses and filter plates suitable for exact welding work by referring to the standard of JIS T8141.

- Wear protectors suitable for preventing contact with arc rays, such as safety leather gloves for welding, long sleeve shirts, foot covers, leather aprons, etc.
- Use, as needed shade curtains for welding by surrounding the welding areas in order to prevent accompanied workers from the arc rays.

**WARNING**

- The tips of the welding wires and filler wires can injure eyes, face, etc.

- Do not lose your hold on the wire when taking off the tip of the wire.
- Do not point the welding torch towards your face when checking the wire feeding condition.

**WARNING**

- Falling down and dropping welding consumables can injure you.

- Wear safety shoes, and pay your attention not to drop welding consumables on your body when you carry and handle them. Keep your posture correct not to cause a crick in your back while handling them.
- Pile up welding consumables so that falling down and dropping cannot take place while storing and carrying them.

**WARNING**

- Fire and explosion can take place.

- Never weld in areas adjacent to highly inflammable materials. Remove consumables so that spatter cannot ignite them. If combustibles cannot be removed, cover them with a noninflammable material.
- Do not weld a vessel or PiPe which contains combustibles or being sealed.
- Do not Put a hot weldment close to combustibles right after welding finished.
- When welding ceiling, floors, walls, etc, remove combustibles at the other side of them.
- Any part of welding wire, with exception of wire extended at the tip of the torch, must be free from touching on the electrical circuit of the base metal side.
- Fasten the cable joints and seal them in a insulation tape. The cable for the base metal side should be connected closer to the part of welding.
- Be ready to cope with a possible accident by equipping fire-extinguishing equipment adjacent to the welding areas.

**WARNING**

- Flying spatters and slags can injure eyes and cause burn skins.
- High temperature heat in welding can cause burn skins.

- Wear safety glasses, safety leather gloves for welding, long sleeve shirts, foot covers, leather aprons, etc.
- Do not touch weldments while hot.

## CERTIFICATE OF APPROVAL

This is to certify that the Quality Management System of:

**Hyundai Welding Co., Ltd.**  
**100, Daesong-ro, Nam-gu, Pohang-si**  
**Gyeongbuk, 37863, Korea**

has been approved by Lloyd's Register Quality Assurance  
to the following Quality Management System Standards:

**ISO 9001:2008**

The Quality Management System is applicable to:

**Design, manufacture and sales of covered electrodes,  
solid wires & rods, flux cored wires,  
submerged arc wires and fluxes.**

This certificate is valid only in association with the certificate schedule bearing the same  
number on which the locations applicable to this approval are listed.

Approval  
Certificate No: SEO0941752

Original Approval: 07 February 1995

Current Certificate: 25 January 2016

Certificate Expiry: 14 September 2018



Issued by: LRQA (Korea) Ltd. for and on behalf of  
Lloyd's Register Quality Assurance Limited



001

17th Floor, Singsong Bldg, 67, Yeouinaru-ro, Yeongdeungpo-gu, Seoul, Korea  
For and on behalf of LRQA Ltd 1 Trinity Park, Bickenhill Lane, Birmingham, B37 7ES, United Kingdom

This approval is carried out in accordance with the LRQA assessment and certification procedures and monitored by LRQA.  
The use of the UKAS Accreditation Mark indicates Accreditation in respect of those activities covered by the Accreditation Certificate Number 001

Lloyd's Register Group Limited, its affiliates and subsidiaries, including Lloyd's Register Quality Assurance Limited (LRQA), and their respective officers, employees or agents are, individually and collectively, referred to in this clause as 'Lloyd's Register'. Lloyd's Register assumes no responsibility and shall not be liable to any person for any loss, damage or expense caused by reliance on the information or advice in this document or howsoever provided, unless that person has signed a contract with the relevant Lloyd's Register entity for the provision of this information or advice and in that case any responsibility or liability is exclusively on the terms and conditions set out in that contract.



Lloyd's Register  
LRQA

## CERTIFICATE OF APPROVAL

This is to certify that the Quality Management System of:

**Hyundai Welding Co., Ltd.**  
**100, Daesong-ro, Nam-gu, Pohang-si**  
**Gyeongbuk, 37863, Korea**

has been approved by Lloyd's Register Quality Assurance  
to the following Quality Management System Standard:

**ISO/TS 16949:2009**

The Quality Management System is applicable to:

**Design and manufacture of solid wires & rods  
and flux cored wires.**

This certificate is valid only in association with the certificate schedule bearing the same  
number on which the locations applicable to this approval are listed.

Approval  
Certificate No: SE00941752

Certification date: 25 January 2016

Certificate Expiry: 14 September 2018

Issued by: LRQA (Korea) Ltd. for and on behalf of  
Lloyd's Register Quality Assurance Limited



IATF Certificate No: 0229931

17th Floor, Singsong Bldg, 67, Yeouinaru-ro, Yeongdeungpo-gu, Seoul, Korea  
For and on behalf of LRQA Ltd 1 Trinity Park, Bickenhill Lane, Birmingham, B37 7ES, United Kingdom  
This approval is carried out in accordance with the LRQA assessment and certification procedures and monitored by LRQA.

More Kinston 15

Lloyd's Register Group Limited, its affiliates and subsidiaries, including Lloyd's Register Quality Assurance Limited (LRQA), and their respective officers, employees or agents are, individually and collectively, referred to in this clause as 'Lloyd's Register'. Lloyd's Register assumes no responsibility and shall not be liable to any person for any loss, damage or expense caused by reliance on the information or advice in this document or howsoever provided, unless that person has signed a contract with the relevant Lloyd's Register entity for the provision of this information or advice and in that case any responsibility or liability is exclusively on the terms and conditions set out in that contract.



Lloyd's Register  
LRQA

## CERTIFICATE OF APPROVAL

This is to certify that the Environmental Management System of:

**Hyundai Welding Co., Ltd.**  
**100, Daesong-ro, Nam-gu, Pohang-si**  
**Gyeongbuk, Korea**

has been approved by Lloyd's Register Quality Assurance  
to the following Environmental Management System Standard:

**ISO 14001:2004**

The Environmental Management System is applicable to:

**Design and manufacture of covered electrodes,  
solid wires & rods, flux cored wires,  
submerged arc wires and fluxes.**

Approval  
Certificate No: SEO 0032015

Original Approval: 10 February 2004

Current Certificate: 10 February 2016

Certificate Expiry: 14 September 2018

Issued by: LRQA (Korea) Ltd. for and on behalf of  
Lloyd's Register Quality Assurance Limited



17th Floor, Singsong Bldg, 67, Yeouinaru-ro, Yeongdeungpo-gu, Seoul, Korea  
For and on behalf of LRQA Ltd 1 Trinity Park, Bickenhill Lane, Birmingham, B37 7ES, United Kingdom

This approval is carried out in accordance with the LRQA assessment and certification procedures and monitored by LRQA.  
The use of the UKAS Accreditation Mark indicates Accreditation in respect of those activities covered by the Accreditation Certificate Number 001

Lloyd's Register Group Limited, its affiliates and subsidiaries, including Lloyd's Register Quality Assurance Limited (LRQA), and their respective officers, employees or agents are, individually and collectively, referred to in this clause as 'Lloyd's Register'. Lloyd's Register assumes no responsibility and shall not be liable to any person for any loss, damage or expense caused by reliance on the information or advice in this document or howsoever provided, unless that person has signed a contract with the relevant Lloyd's Register entity for the provision of this information or advice and in that case any responsibility or liability is exclusively on the terms and conditions set out in that contract.





# Note

---

<b>1<sup>ST</sup> EDITION</b>	<b>1989. 9.</b>
<b>2<sup>ND</sup> EDITION</b>	<b>1998. 11.</b>
<b>3<sup>RD</sup> EDITION</b>	<b>1999. 1.</b>
<b>4<sup>TH</sup> EDITION</b>	<b>2001. 8.</b>
<b>5<sup>TH</sup> EDITION</b>	<b>2003. 2.</b>
<b>6<sup>TH</sup> EDITION</b>	<b>2004. 9.</b>
<b>7<sup>TH</sup> EDITION</b>	<b>2005. 8.</b>
<b>8<sup>TH</sup> EDITION</b>	<b>2006. 12.</b>
<b>9<sup>TH</sup> EDITION</b>	<b>2008. 1.</b>
<b>10<sup>TH</sup> EDITION</b>	<b>2009. 1.</b>
<b>11<sup>TH</sup> EDITION</b>	<b>2010. 4.</b>
<b>12<sup>TH</sup> EDITION</b>	<b>2011. 6.</b>
<b>13<sup>TH</sup> EDITION</b>	<b>2013. 5.</b>
<b>13<sup>TH</sup> EDITION (REVISED)</b>	<b>2013. 8.</b>
<b>14<sup>TH</sup> EDITION</b>	<b>2014. 7.</b>
<b>14<sup>TH</sup> EDITION (REVISED)</b>	<b>2016. 2.</b>

# Overseas Offices

## **HYUNDAI WELDING CO., LTD. (HEAD OFFICE)**

ILSONG BLDG. 16TH FL. 507, TEHERAN-RO,  
GANGNAM-GU, SEOUL  
TEL: (+82-2) 6230-6032~35, 51-68, 76~81  
FAX: (+82-2) 522-2030, 525-7317

## **HYUNDAI WELDING JAPAN CO., LTD. (OSAKA)**

8TH FLOOR, SHINOSAKA ROSE B/D 5-12-10,  
NISHINAKAJIMA, YODOGAWA-KU, OSAKA, JAPAN  
TEL: (+81-6) 6305-8700, FAX: (+81-6) 6305-8720

## **HYUNDAI WELDING JAPAN CO., LTD. (TOKYO)**

5TH FLOOR, HIGASHI NIHONBASHI B/D, 1-3-3,  
HIGASHI NIHONBASHI, CHUOKU, TOKYO, JAPAN  
TEL: (+81-3) 3861-2502, FAX: (+81-3) 3861-2512

## **HYUNDAI WELDING JAPAN CO., LTD. (KYUSYU)**

8TH FLOOR ABUNDANT 90 B/D, 3-11-14, HAKATA-  
EKI HIGASHI, HAKATA-KU, FUKUOKA, JAPAN  
TEL: (+81-92) 415-6450, FAX: (+81-92) 415-6593

## **HYUNDAI WELDING JAPAN CO., LTD. (HIROSHIMA)**

3RD FLOOR 510B/D 10-1 HASHIMOTO-CHO, NAKA-  
KU, HIROSHIMA, JAPAN  
TEL: (+81-82) 224-1580, FAX: (+81-82) 224-1581

## **HYUNDAI WELDING JAPAN CO., LTD. (NAGOYA)**

#D 2ND FLOOR RINOFRIENDS, 1-12 NAWA-CHO,  
TOKAI-SHI, AICHI-KEN, NAGOYA, JAPAN  
TEL: (+81-52) 689-5775, FAX: (+81-52) 689-5776

## **HYUNDAI WELDING (S'PORE) PTE., LTD.**

8 BOON LAY WAY #09-13 TRADEHUB 21  
SINGAPORE 609964  
TEL: (+65) 6863-3218, FAX: (+65) 6863-3225

## **HYUNDAI WELDING CO., LTD (SHANGHAI, CHINA)**

UNIT 1708, FEIDIAO INTERNATIONAL PLAZA,  
NO.1065 ZHAOJIABANG ROAD, SHANGHAI, CHINA  
P.C: 200030  
TEL: (+86-21) 6486-6699(+803)  
FAX: (+86-21) 3368-0580

## **HYUNDAI WELDING DALIAN OFFICE (CHINA)**

ROOM 1105, DALIAN INTERNATIONAL HOTEL, NO.9  
RENMIN ROAD, DALIAN, CHINA P.C: 116001  
TEL: (+86-411) 8265-4798, FAX: (+86-411) 8259-3748

## **HYUNDAI WELDING GUANGZHOU OFFICE (CHINA)**

ROOM G, 16/F, ZHONGQIAO BUILDING, NO.76  
XIANLIE ZHONG ROAD, GUANGZHOU, CHINA  
P.C: 510095  
TEL: (+86-20) 8732-5007, FAX: (+86-20) 8732-2595

## **HYUNDAI WELDING QINGDAO OFFICE (CHINA)**

ROOM2002, UNIT 2 BUILDING, HUANYUKANGTING,  
NO118, SHANGDONG ROAD, QINGDAO, CHINA  
TEL: (+86-532) 8086-2925, FAX: (+86-532) 8086-2926

## **HYUNDAI WELDING PRODUCTS, INC. (USA, ATLANTA)**

SATELLITE BOULEVARD SUITE 300 ATLANTA, GA  
30024  
TEL: (+1-770) 614-7577, FAX: (+1-770) 614-6636

## **HYUNDAI WELDING EUROPE OFFICE (NETHERLANDS)**

SEATTLEWEG 5, 3195 ND ROTTERDAMPERNIS, THE  
NETHERLANDS  
TEL: (+31-10) 494-5788, FAX: (+31-10) 494-5778