



2020

VOREL 



STHOR



LUND



FLO 

STHOR



FALA 



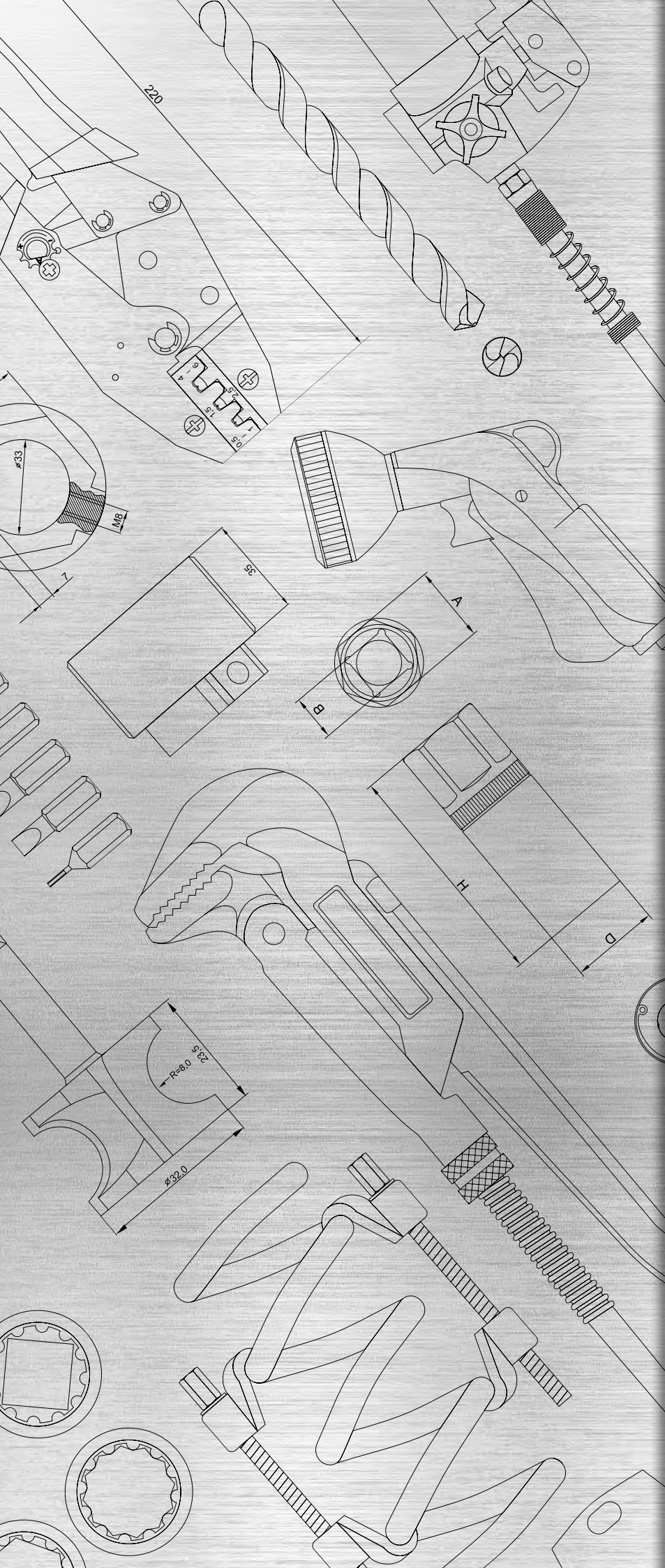

TOYA SA
ul. Soltysowicka 13-15
51-168 Wrocław
☎ (+48 71) 32 46 200
fax: (+48 71) 32 46 370

sales@yato.pl (sale)
export@yato.pl (export)
import@yato.pl (import)

ODDZIAŁ WARSZAWSKI
Teren ProLogis Park Nadarzyn
al. Kasztanowa 160
05-831 Młochów k. Warszawy

☎ (+48 22) 73 82 800
☎ (+48 22) 73 82 828
sales@yato.pl (sale)
export@yato.pl (export)

1 Spanners Klucze

6-13



2 Sockets, accessories & sets Klucze nasadowe, akcesoria i zestawy

14-23



3 Screwdrivers & screwdriver bits Wkrętaki i końcówki wkrętakowe

24-45



4 Pliers & pipe wrenches Szczypce i klucze do rur

46-55



5 Electrician tools Narzędzia dla elektryków

56-61



6 Hammers, chisels, punches & axes Młotki, dłuta, przecinaki i siekiery

62-71



7 Clamps & vices Ściski i imadła

72-77



8 Cutting tools Narzędzia tnące

78-119



9 Plumbing tools 120-127

Narzędzia hydrauliczne

**10 Fastening tools** 128-145

Narzędzia do łączenia

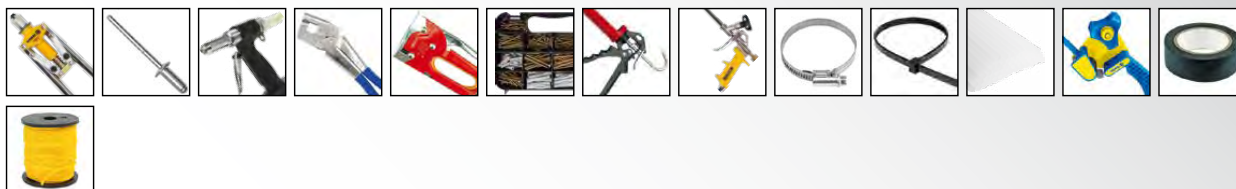
**11 Plastering & bricklaying tools** 146-179

Narzędzia budowlane i malarskie

**12 Measuring tools** 180-193

Narzędzia miernicze

**13 Pneumatic tools** 194-207

Narzędzia pneumatyczne

**14 Special automotive tools & equipment** 208-239

Narzędzia i wyposażenie warsztatu samochodowego

**15 Power tools & accessories** 240-275

Elektronarzędzia i akcesoria



16 Welding equipment Sprzęt spawalniczy

276-285



17 Safes, padlocks & locks Sejfy, kłódki i zamki

286-293



18 Accessories Akcesoria

294-299



19 Bicycle accessories Akcesoria rowerowe

300-305



20 Kitchen and home appliance Sprzęt AGD

306-327



21 Household equipment Gospodarstwo domowe

328-357



22 Health & safety products Artykuły BHP

358-373



1

Spanners Klucze



Combination spanners Klucze płasko-oczkowe

8-10



Combination spanners & sets, polished head

Klucze płasko-oczkowe i zestawy,
polerowana główka.....

8

Combination spanners & sets, satin finish CrV

Klucze płasko-oczkowe i zestawy,
wykończenie satynowe CrV.....

9

Combination ratchet wrenches Klucze płasko-oczkowe z grzechotką

10



Combination ratchet wrenches

Klucze płasko-oczkowe z grzechotką.....

10

Combination ratchet wrench sets

Zestawy kluczy płasko-oczkowych z grzechotką.....

10

Double open end spanners Klucze płaskie

10-11



Double open end spanners & sets, polished head

Klucze płaskie i zestawy, polerowana główka.....

10

Double open end spanner sets, satin finish CrV

Zestawy kluczy płaskich,
wykończenie satynowe CrV.....

11

Bi-hexagonal ring spanners Klucze oczkowe odgięte

11



Bi-hexagonal ring spanners & sets, polished head

Klucze oczkowe odgięte i zestawy,
polerowana główka.....

11

Open end swivel socket spanners Klucze płasko-nasadowe

11



T-type deep socket wrenches Klucze nasadowe typu „T”

11

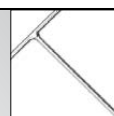

Box end wrenches Klucze rurowe

12



L-type wrenches Klucze nasadowe typu „L”

12



Multipipe wrenches Klucze uniwersalne

12



Double ratchet wrenches Klucze rurowe

12



Adjustable wrenches Klucze nastawne

12-13



Torque wrenches Klucze dynamometryczne

13



1

PL Klucz plasko-oczkowy CZ Plochý a očkový klíč
 GB Combination spanner RO Cheie combinata
 D Maulringschlüssel H Kulcs villás-csillag
 RUS Ключ комбинированный E Combinada con llave de estrella



No.	mm	
51060	6	200/1200
51070	7	200/1000
51080	8	100/600
51090	9	60/600
51100	10	50/600
51110	11	50/400
51120	12	50/400
51130	13	50/400
51140	14	50/300
51150	15	50/300
51160	16	50/200
51170	17	20/200
51180	18	25/200
51190	19	30/120
51200	20	20/160
51210	21	20/120
51220	22	30/120
51240	24	15/90
51270	27	15/60
51300	30	10/40
51320	32	10/40

PL Komplet kluczy plasko-oczkowych CZ Souprava plochých a očkových klíčů
 GB Combination spanner set RO Set chei combinate
 D Maulringschlüsselsatz H Kulcskészlet villás-csillag clip
 RUS Набор комбинированных ключей E Juego de combinadas con llave de estrella



No.	mm	pcs	
51580	6; 8; 10; 11; 13; 14; 17; 19	8	5/50
51620	6; 7; 8; 9; 10; 11; 12; 13; 14; 17; 19; 22	12	5/20
51650	6; 7; 8; 9; 10; 11; 12; 13; 14; 15; 16; 17; 18; 19; 20; 21; 22; 23; 24; 25; 26; 27; 28; 30; 32	25	4

PL Klucz plasko-oczkowy CZ Plochý a očkový klíč
 GB Combination spanner RO Cheie combinata
 D Maulringschlüssel H Kulcs villás-csillag
 RUS Ключ комбинированный E Combinada con llave de estrella



STHOR

No.	mm	
51040	6	200/1200
51042	8	100/600
51044	10	50/600
51046	12	50/400
51047	13	50/400
51048	14	50/300
51049	15	50/300
51051	17	20/200

PL Komplet kluczy plasko-oczkowych CZ Souprava plochých a očkových klíčů
 GB Combination spanner set RO Set chei combinate
 D Maulringschlüsselsatz H Kulcskészlet villás-csillag clip
 RUS Набор комбинированных ключей E Juego de combinadas con llave de estrella



No.	mm	pcs	
51560	8; 10; 12; 13; 14; 17	6	15/60
51590	6; 8; 10; 12; 13; 14; 17; 19	8	10/40
51630	6; 7; 8; 9; 10; 11; 12; 13; 14; 17; 19; 22	12	5/20
51640	6; 7; 8; 9; 10; 11; 12; 13; 14; 17; 19; 21; 24; 27; 32	15	2/12
51645	6; 7; 8; 9; 10; 11; 12; 13; 14; 15; 16; 17; 18; 19; 21; 22; 24; 27; 30; 32	20	8

PL Komplet kluczy plasko-oczkowych CZ Souprava plochých a očkových klíčů
 GB Combination spanner set RO Set chei combinate
 D Maulringschlüsselsatz H Kulcskészlet villás-csillag clip
 RUS Набор комбинированных ключей E Juego de combinadas con llave de estrella



VOREL

No.	mm	pcs	
50850	8; 10; 12; 13; 14; 17	6	4/40
50861	6; 8; 10; 13; 14; 17; 19; 22	8	4/32
50871	6; 7; 8; 9; 10; 11; 12; 13; 14; 17; 19; 22	12	2/20

PL Komplet kluczy plasko-oczkowych
GB Combination spanner set
D Maulringschlüsselsatz
RUS Набор комбинированных ключей

CZ Souprava plochých a očkových klíčů
RO Set chei combinate
H Kulcskészlet villás-csillag clip
E Juego de combinadas con llave de estrella

9
PCS

CrV



No.	size / rozmiar	pcs	box
50880	1/4" (6.3 mm); 5/16" (7.9 mm); 3/8" (9.5 mm); 7/16" (11.1 mm); 1/2" (12.7 mm); 9/16" (14.3 mm); 5/8" (15.9 mm); 17/16" (17.5 mm); 3/4" (19.0 mm)	9	10

PL Komplet kluczy plasko-oczkowych
GB Combination spanner set
D Maulringschlüsselsatz
RUS Набор комбинированных ключей

CZ Souprava plochých a očkových klíčů
RO Set chei combinate
H Kulcskészlet villás-csillag clip
E Juego de combinadas con llave de estrella

CrV



No.	mm	pcs	box
51720	8; 10; 12; 13; 14; 17	6	4/40
51721	6; 8; 10; 12; 13; 14; 17; 19	8	4/32
51722	6; 7; 8; 9; 10; 11; 12; 13; 14; 17; 19; 22	12	2/20

PL Komplet kluczy plasko-oczkowych
GB Combination spanner set
D Maulringschlüsselsatz
RUS Набор комбинированных ключей

CZ Souprava plochých a očkových klíčů
RO Set chei combinate
H Kulcskészlet villás-csillag clip
E Juego de combinadas con llave de estrella

8
PCS

CrV



No.	mm	pcs	box
51705	8; 10; 12; 13; 14; 15; 17; 19	8	30

PL Klucz plasko-oczkowy
GB Combination spanner
D Maulringschlüssel
RUS Ключ комбинированный

CZ Plochý a očkový klíč
RO Cheie combinata
H Kulcs villás-csillag
E Combinada con llave de estrella

CrV



1



No.	mm	box
51671	6	20/400
51672	7	20/400
51673	8	20/400
51674	9	20/400
51675	10	20/320
51676	11	20/240
51677	12	20/240
51678	13	20/200
51679	14	20/200
51680	15	20/200
51681	16	20/200
51682	17	20/160
51683	18	20/160
51684	19	20/160
51685	20	20/120
51686	21	20/120
51687	22	20/120
51688	23	10/80
51689	24	10/80
51690	25	10/60
51691	26	10/40
51692	27	10/40
51693	28	10/40
51694	29	10/40
51695	30	10/40
51696	32	10/40

PL Komplet kluczy plasko-oczkowych
GB Combination spanner set
D Maulringschlüsselsatz
RUS Набор комбинированных ключей

CZ Souprava plochých a očkových klíčů
RO Set chei combinate
H Kulcskészlet villás-csillag clip
E Juego de combinadas con llave de estrella

12
PCS

CrV



No.	mm	pcs	box
51710	6; 8; 10; 11; 12; 13; 14; 15; 17; 18; 19; 22	12	20

1

- PL Komplet kluczy plasko-oczkowych
 GB Combination spanner set
 D Maulringschlüsselsatz
 RUS Набор комбинированных ключей
- CZ Souprava plochých a očkových klíčů
 RO Set chei combinate
 H Kulcskészlet villás-csillag
 E Juego de combinadas con llave de estrella



No.	mm	pcs	
51715	6; 7; 8; 9; 10; 11; 12; 13; 14; 15; 16; 17; 18; 19; 20; 21; 22; 23; 24; 25; 26; 27; 28; 30; 32	25	4

- PL Zestaw kluczy plasko-oczkowych z grzechotką
 GB Combination ratchet wrench set
 D Ratschenringmaulschlüssel-Satz
 RUS Набор комбинированных ключей с трещоткой
 CZ Klíče ráčnové sada
 RO Set chei combinate
 H Racsnis csillag-villás kulcs készlet
 E Juego de llaves planas con matraca



No.	mm	pcs	
52661	10; 13; 17; 19	4	10/20

- PL Komplet kluczy plaskich
 GB Double open end spanner set
 D Doppelmaulschlüsselsatz
 RUS Набор ключей рожковых
- CZ Souprava plochých klíčů
 RO Set chei fixe
 H Kulcskészlet, villás
 E Juego de llaves fijas



No.	mm	pcs	
50560	6x7; 8x9; 10x11; 12x13; 14x15; 16x17	6	20/80
50590	6x7; 8x9; 10x11; 12x13; 14x15; 16x17; 18x19; 20x22	8	10/40
50610	6x7; 8x9; 10x11; 12x13; 14x15; 16x17; 18x19; 20x22; 24x27; 30x32	10	5/20
50630	6x7; 8x9; 10x11; 12x13; 14x15; 16x17; 18x19; 20x22; 21x23; 24x26; 25x28; 27x32	12	5/15

- PL Klucz plasko-oczkowy z grzechotką
 GB Combination ratchet wrench
 D Ratschenringmaulschlüssel
 RUS Ключ комбинированный с трещоткой
 CZ Klíč oškorplochy ráčnový
 RO Cheie combinata cu crichet
 H Csillag-villás kulcs racsnis
 E Llave combinada fija abierta y carraca



No.	mm	
52652	10	10/100
52653	11	10/100
52654	12	10/100
52655	13	10/100
52656	14	10/100
52657	15	10/100
52658	17	10/50
52659	19	10/50
52660	22	10/40

- PL Klucz plaski
 GB Double open end spanner
 D Doppelmaulschlüssel
 RUS Ключ рожковый
- CZ Plochý klíč
 RO Cheie fixa
 H Villáskulcs
 E Llave fija



No.	mm	
50070	6x7	100/1000
50090	8x9	60/600
50100	8x10	60/600
50110	10x11	60/600
50120	10x13	50/500
50130	12x13	50/500
50150	14x15	50/300
50170	13x17	50/300
50190	17x19	30/180
50220	19x22	30/180
50270	24x27	25/100
50330	30x32	15/60

- PL Komplet kluczy plaskich
 GB Double open end spanner set
 D Doppelmaulschlüsselsatz
 RUS Набор ключей рожковых
- CZ Souprava plochých klíčů
 RO Set chei fixe
 H Kulcskészlet, villás
 E Juego de llaves fijas



No.	mm	pcs	
50580	6x7; 8x9; 10x11; 12x13; 14x15; 16x17; 18x19; 20x22	8	10/40
50620	6x7; 8x9; 10x11; 12x13; 14x15; 16x17; 18x19; 20x22; 21x23; 24x26; 25x28; 27x32	12	5/15

PL Komplet kluczy płaskich
GB Double open end spanner set
D Doppelmaulschlüsselsatz
RUS Набор ключей рожковых

CZ Souprava plochých klíčů
RO Set chei fixe
H Kulcskészlet, villás
E Juego de llaves fijas



VOREL

No.	mm	pcs	
51740	6x7; 8x9; 10x11; 12x13; 14x15; 16x17	6	4/40
51741	6x7; 8x9; 10x11; 12x13; 14x15; 16x17; 18x19; 20x22	8	4/24

PL Komplet kluczy oczkowych odgiętych
GB Bi-hexagonal ring spanner set
D Doppelringschlüsselsatz
RUS Набор ключей накидных изогнутых

CZ Klíče očkové vyhnuté sada
RO Set chei inelare cu cot
H Csillagkulcs készlet
E Juego de llaves de estrella acodadas

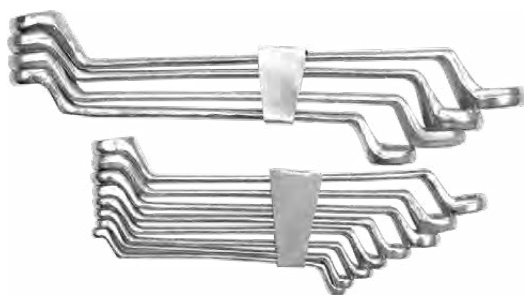

No.	mm	pcs	
52560	6x7; 8x9; 10x11; 12x13; 14x15; 16x17	6	6/36
52570	6x7; 8x9; 10x11; 12x13; 14x15; 16x17; 18x19; 20x22	8	5/20
52630	6x7; 8x9; 10x11; 12x13; 14x15; 16x17; 18x19; 20x21; 22x23; 24x25; 26x27; 28x32	12	2/8

PL Klucz płasko-nasadowy, przegubowy
GB Open end swivel head socket wrench
D Maul-Steckschlüssel
RUS Ключ рожково-торцевой с шарниром

CZ Klic nasad. ploch.
RO Chei fixe-tubulare
H Kulcs villás-dugó
E Combinada con vaso



No.	mm	
52680	8	20/200
52700	10	20/200
52710	11	20/200
52720	12	20/200
52730	13	20/200
52740	14	20/200
52750	15	25/100
52770	17	25/100
52790	19	25/50
52820	22	25/50

PL Klucz oczkowy odgięty
GB Bi-hexagonal ring spanner
D Doppelringschlüssel
RUS Ключ накидной изогнутый

CZ Očkový klíč ohnutý
RO Cheie inelare-curbată
H Hajítottszárú csillagkulcs
E Llave de estrella

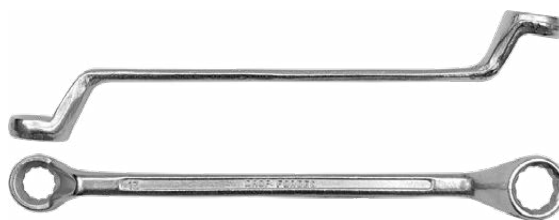

No.	mm	
52100	8x10	50/300
52120	10x13	50/200
52130	12x13	50/200
52170	13x17	30/120
52190	17x19	25/100
52220	19x22	20/80
52270	24x27	10/60
52340	30x32	5/40

PL Komplet kluczy oczkowych odgiętych
GB Bi-hexagonal ring spanner set
D Doppelringschlüsselsatz
RUS Набор ключей накидных изогнутых

CZ Klíče očkové vyhnuté sada
RO Set chei inelare cu cot
H Csillagkulcs készlet
E Juego de llaves de estrella acodadas

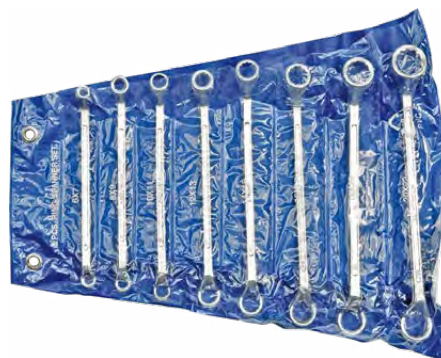

No.	mm	pcs	
52580	6x7; 8x9; 10x11; 12x13; 14x15; 16x17; 18x19; 20x22	8	5/20

PL Klucz nasadowy typu „T”
GB T-type socket wrench
D T-Griff-Steckschlüssel
RUS Ключ торцевой Т-образный

CZ Čepový a nastrčný klíč
RO Cheie tubulara tip „T”
H Kulcs, csap-dugó
E Llave mandril vaso



No.	L (mm)	mm	
56710	380	8	50
56720	380	10	50
56730	380	13	50
56740	380	17	50
56770	190	8	50
56780	190	10	50
56790	190	13	50

1

PL Komplet kluczy rurowych
GB Tubular socket wrench set
D Rohrsteckschlüsselsatz
RUS Набор ключей трубчатых

CZ Klíče trubkové
RO Chei pt. țevi
H Csőkulcs
E Llaves de tuberia

10
PCS



No.	mm	pcs	
52900	6-22	10	6/24

PL Klucze uniwersalne
GB Multipipe wrenches
D Universalschlüssel
RUS Ключи универсальные

CZ Univerzální klíče
RO Chei universale
H Univerzális kulcs
E Juego de llaves universales



VOREL

No.	mm	pcs	
54000	9-32	2	20/40

PL Klucze rurowe
GB Double ratchet wrench
D Gerüstratsche
RUS Ключ торцевой с трещоткой

CZ Ráčňový kľúč průchozí dvoustranný
RO Cheie tubulara dubla cu clichet
H Kettős racsnis kulcs
E Llave de vaso con carraca

32T



VOREL

No.	mm	
52935	17x19	2/40
52936	19x22	2/40

PL Klucz nasadowy typu „L”
GB L-type socket wrench
D Steckschlüssel gebogen
RUS Ключ торцевой L-типа

CZ Nástrčný kľúč fajfkový
RO Cheie tubulara cu cot tip „L”
H Kulcs, dugó-pipa
E Llave de vaso „L”



No.	mm	
54600	6	20/240
54610	7	20/240
54620	8	20/240
54630	9	20/240
54640	10	20/240
54650	11	20/200
54660	12	20/200
54670	13	20/200
54680	14	10/100
54690	15	10/100
54700	16	10/100
54710	17	10/80
54720	18	10/80
54730	19	10/80
54750	21	10/60
54760	22	10/60
54780	24	10/40

PL Klucz nastawny
GB Adjustable wrench
D Rollgabelschlüssel
RUS Ключ разводной

CZ Nastavitelný kľúč
RO Cheie reglabilă
H Állítható
E Llave ajustable



VOREL

No.	L (mm)	
54061	200	6/60
54062	250	6/36
54063	300	6/24

PL Klucz nastawny CZ Nastawitelny klíč
 GB Adjustable wrench RO Cheie reglabilă
 D Rollgabelschlüssel H Állítható
 RUS Ключ разводной E Llave ajustable



No.	L (mm)	packing	
54065	150		6/120
54066	200		6/60
54067	250		6/36
54068	300		6/24
54080	375		6/12
54081	450		6

PL Klucz dynamometryczny wychylny
 GB Torque wrench
 D Drehmomentschlüssel
 RUS Ключ динамометрический стрелочный
 CZ Dynamometrický klíč
 RO Cheie cu dinamometru
 H Nyomatékkulcs
 E Llave dinamometrico inclin.

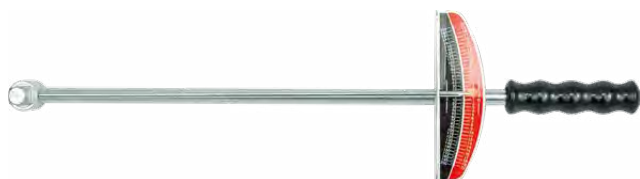
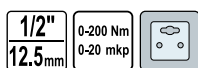

No.	size / rozmiar	
57450	1/2" (12.7 mm)	6/24

PL Klucz dynamometryczny wychylny
 GB Torque wrench
 D Drehmomentschlüssel
 RUS Ключ динамометрический стрелочный
 CZ Dynamometrický klíč
 RO Cheie cu dinamometru
 H Nyomatékkulcs
 E Llave dinamometrico inclin.

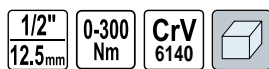

No.	size / rozmiar	
57451	1/2" (12.7 mm)	16

PL Klucz nastawny CZ Nastawitelny klíč
 GB Adjustable wrench RO Cheie reglabilă
 D Rollgabelschlüssel H Állítható
 RUS Ключ разводной E Llave ajustable



1



No.	L (mm)	
54070	150	6/120
54071	200	6/60
54072	250	6/36
54073	300	6/24

PL Klucz dynamometryczny CZ Dynamometrický klíč
 GB Torque wrench RO Cheie cu dinamometru
 D Drehmomentschlüssel H Nyomatékkulcs
 RUS Ключ динамометрический E Llave dinamometrico



No.	size / rozmiar	L (mm)	Nm	packing	
57300	3/8" (9.5 mm)	270	13.6 - 108		20
57350	1/2" (12.7 mm)	465	28.0 - 210		10
57400	3/4" (19.0 mm)	625	68.0 - 406		10

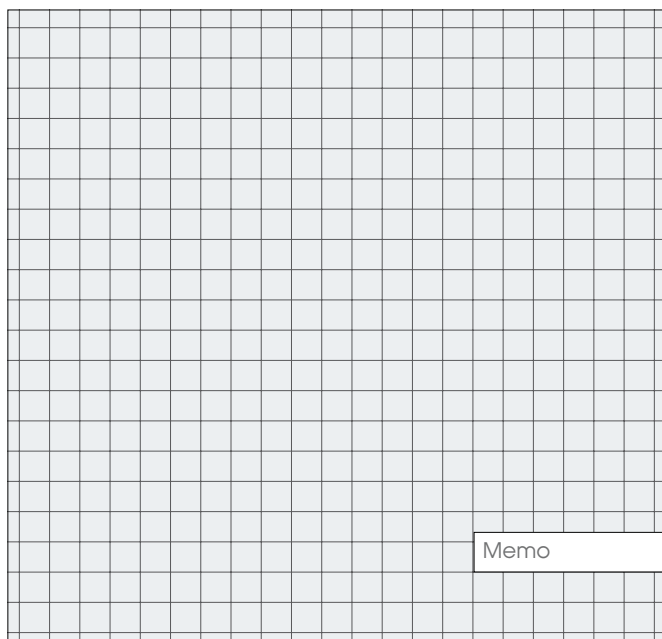

2

Sockets, accessories & sets Klucze nasadowe, akcesoria i zestawy



Sockets**Klucze nasadowe**

16

**Hexagonal sockets 1/2"**

Klucze nasadowe sześciokątne 1/2"..... 16

Hexagonal sockets 3/4"

Klucze nasadowe sześciokątne 3/4"..... 16

Universal wrench sockets

Nasadki uniwersalne..... 16

Accessories**Akcesoria**

16-17

**Extension bars**

Przedłużki..... 16

Universal joints

Przeguby Cardana..... 17

Sliding T-bars

Pokręta typu „T”..... 17

Speed braces

Rękojeści wygięte..... 17

Ratchet handles**Grzechotki**

17-18

**Socket & tool sets****Zestawy kluczy nasadowych i narzędziowych**

18-23



2

Socket sets 1/4"

Zestawy kluczy nasadowych 1/4"..... 18

Socket sets 3/8"

Zestawy kluczy nasadowych 3/8"..... 18

Socket sets 1/2"

Zestawy kluczy nasadowych 1/2"..... 18

Socket sets 3/4"

Zestawy kluczy nasadowych 3/4"..... 19

Tool sets

Zestawy narzędziowe..... 19

PL Nasadka sześciokątna
GB Hexagonal socket
D Sechskantenschlüssel
RUS Торцевая головка 6-гранная

CZ Šestihřanný nástavec
RO Cheie tubulară hexagonală
H Hatszögű rátét
E Boquilla hexagonal corta

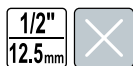

No.	mm	size / rozmiar	
53080	8	1/2" (12.7 mm)	150/300
53100	10	1/2" (12.7 mm)	150/300
53120	12	1/2" (12.7 mm)	150/300
53130	13	1/2" (12.7 mm)	150/300
53140	14	1/2" (12.7 mm)	150/300
53150	15	1/2" (12.7 mm)	150/300
53160	16	1/2" (12.7 mm)	150/300
53170	17	1/2" (12.7 mm)	125/250
53180	18	1/2" (12.7 mm)	100/200
53190	19	1/2" (12.7 mm)	100/200
53210	21	1/2" (12.7 mm)	75/150
53220	22	1/2" (12.7 mm)	75/150
53240	24	1/2" (12.7 mm)	50/100
53270	27	1/2" (12.7 mm)	50/100
53300	30	1/2" (12.7 mm)	40/80
53320	32	1/2" (12.7 mm)	40/80

PL Nasadka uniwersalna
GB Universal wrench socket
D Universal Steckschlüssel
RUS Головка универсальная

CZ Univerzální šroubovací nástavec
RO Cheie tubulara universala
H Univerzálnis dugókulcs
E Universal llave de cubo



VOREL

No.	mm	size / rozmiar	
53002	7-19	3/8" (9.5 mm)	8/48
53003	11-32	1/2" (12.7 mm)	6/24

PL Przedłużka
GB Extension bar
D Verlängerung
RUS Удлинитель для воротка

CZ Prodlužovací přípravek
RO Prelungitor
H Hosszabbító
E Tubo de prolongación



No.	size / rozmiar	L (mm)	
53610	1/2" (12.7 mm)	125	50/100
53630	1/2" (12.7 mm)	250	25/50

PL Nasadka sześciokątna
GB Hexagonal socket
D Sechskantenschlüssel
RUS Торцевая головка 6-гранная

CZ Šestihřanný nástavec
RO Cheie tubulară hexagonală
H Hatszögű rátét
E Boquilla hexagonal corta

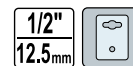

STWOR

No.	mm	size / rozmiar	
53332	10	1/2" (12.7 mm)	10/300
53335	13	1/2" (12.7 mm)	10/300
53336	14	1/2" (12.7 mm)	5/300
53337	15	1/2" (12.7 mm)	5/300
53338	16	1/2" (12.7 mm)	5/300
53339	17	1/2" (12.7 mm)	5/250
53340	18	1/2" (12.7 mm)	5/200
53341	19	1/2" (12.7 mm)	5/200

PL Nasadka sześciokątna
GB Hexagonal socket
D Sechskantenschlüssel
RUS Торцевая головка 6-гранная

CZ Šestihřanný nástavec
RO Cheie tubulară hexagonală
H Hatszögű rátét
E Boquilla hexagonal corta

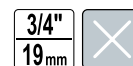

No.	mm	size / rozmiar	
53400	22	3/4" (19.0 mm)	50
53410	24	3/4" (19.0 mm)	50
53420	27	3/4" (19.0 mm)	50
53430	30	3/4" (19.0 mm)	50
53440	32	3/4" (19.0 mm)	50
53450	36	3/4" (19.0 mm)	50
53460	38	3/4" (19.0 mm)	40
53470	41	3/4" (19.0 mm)	25
53480	46	3/4" (19.0 mm)	20
53490	50	3/4" (19.0 mm)	20



VOREL

No.	size / rozmiar	L (mm)	
53650	3/4" (19.0 mm)	100	60
53670	3/4" (19.0 mm)	200	25

PL Przegub Cardana CZ Kardanový kloub
 GB Universal joint RO Articulație Cardanică
 D Kardangelenk H Kardan csukló
 RUS Карданный шарнир E Articulación Cardan



No.	size / rozmiar	L (mm)	
53598	1/4" (6.3 mm)	150/300	
53599	3/8" (9.5 mm)	100/200	
53600	1/2" (12.7 mm)	60/120	

PL Rękojeść wygięta CZ Ohnutá rukojeť
 GB Speed brace RO Măner curbat (manivelă)
 D Kurbelverlängerung H Hajlított markolat /korba/
 RUS Вороток-коловорот E Mango encorvado /manivela/



No.	size / rozmiar	L (mm)	
53730	1/2" (12.7 mm)	400	40

PL Grzechotka CZ Řehtačka
 GB Ratchet handle RO Antrenor cu clichet
 D Hebelumschaltknarre H Racsni
 RUS Трещотка для торцевых головок E Llave de carraca



No.	size / rozmiar	L (mm)	
53561	1/4" (6.3 mm)	135	40/80
53562	3/8" (9.5 mm)	190	25/50
53563	1/2" (12.7 mm)	240	20/40

PL Grzechotka CZ Řehtačka
 GB Ratchet handle RO Antrenor cu clichet
 D Hebelumschaltknarre H Racsni
 RUS Трещотка с изогнутой ручкой E Llave de carraca



No.	size / rozmiar	L (mm)	teeth / zęby	
53571	1/4" (6.3 mm)	150	72	6/36
53572	3/8" (9.5 mm)	200	72	6/36
53573	1/2" (12.7 mm)	260	72	6/36

PL Pokrętko typu „T” CZ Otočná račka typ „T”
 GB Sliding t-bar RO Măner clupă tipul „T”
 D Handgriff mit Gleitstück H „T” alakú hajtókár
 RUS Вороток для торцевых головок Т-образный E Mango tipo „T”



No.	size / rozmiar	L (mm)	
53700	1/2" (12.7 mm)	250	25/50



No.	size / rozmiar	L (mm)	
53710	3/4" (19.0 mm)	450	20

PL Grzechotka CZ Řehtačka
 GB Ratchet handle RO Antrenor cu clichet
 D Hebelumschaltknarre H Racsni
 RUS Трещотка для торцевых головок E Llave de carraca



No.	size / rozmiar	L (mm)	
53500	1/4" (6.3 mm)	125	40/80
53520	3/8" (9.5 mm)	195	25/50
53540	1/2" (12.7 mm)	250	20/40

PL Grzechotka przegubowa CZ Kloubová řehtačka
 GB Flexible ratchet handle RO Antrenor cu clichet, flexibil
 D Gelenk-Hebelumschaltknarre H Csuklós racsni
 RUS Трещотка шарнирная E Llave de carraca articulada

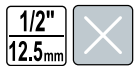

No.	size / rozmiar	L (mm)	
53560	1/2" (12.7 mm)	250	25/50

PL Grzechotka CZ Řehtačka
 GB Ratchet handle RO Antrenor cu clichet
 D Hebelumschaltknarre H Racsni
 RUS Трещотка с пластиковым покрытием E Llave de carraca



No.	size / rozmiar	L (mm)	teeth / zęby	
53575	1/4" (6.3 mm)	155	72	12/72
53576	3/8" (9.5 mm)	200	72	6/48
53577	1/2" (12.7 mm)	250	72	6/36

PL Grzechotka
GB Ratchet handle
D Hebelumschaltknarre
RUS Трещотка для торцевых головок

CZ Řehtačka
RO Antrenor cu cichet
H Racsni
E Llave de carraca



2



No.	size / rozmiar	L (mm)	pcs	box
53580	3/4" (19.0 mm)	500	10	1

PL Komplet nasadek z akcesoriami
GB Socket set
D Sechskantenschlüssel-Einsatz
RUS Набор торцевых головок

CZ Sada nástrčných kľučí a ráčny
RO Trusă de scule
H Dugókulcs készlet racsnis hajtókarral
E Juego de boquillas con accesorios



3/8" (9.5 mm) x 190 mm; 1/4" (6.3 mm) x 50 mm; 3/8" (9.5 mm) x 21 mm;
3/8" (9.5 mm) x 70 mm; 3/8" (9.5 mm); 1/4" (6.3 mm) x 3/8" (9.5 mm); 1/4" (6.3 mm);
4, 4.5, 5, 5.5, 6, 7, 8, 9, 10, 11, 12 mm; 3/8" (9.5 mm): 13, 14, 17 mm

No.	pcs	box
58210	20	10

PL Komplet nasadek z akcesoriami
GB Socket set
D Sechskantenschlüssel-Einsatz
RUS Набор торцевых головок

CZ Sada nástrčných kľučí a ráčny
RO Trusă de scule
H Dugókulcs készlet racsnis hajtókarral
E Juego de boquillas con accesorios



1/2" (12.7 mm) x 240 mm; 1/2" (12.7 mm): 10, 11, 12, 13, 14, 15, 16, 17, 18, 19, 20, 21, 22, 23, 24, 27, 30, 32 mm; 1/2" (12.7 mm) x 21 mm; 1/2" (12.7 mm) x 250 mm; 1/2" (12.7 mm) x 390 mm; 1/2" (12.7 mm) x 125 mm; 1/2" (12.7 mm) x 250 mm

No.	pcs	box
58260	24	5

PL Komplet nasadek z akcesoriami
GB Socket set
D Sechskantenschlüssel-Einsatz
RUS Набор торцевых головок

CZ Sada nástrčných kľučí a ráčny
RO Trusă de scule
H Dugókulcs készlet racsnis hajtókarral
E Juego de boquillas con accesorios



1/4" (6.3 mm) x 120 mm;
1/4" (6.3 mm) x 50 mm;
1/4" (6.3 mm): 4, 4.5, 5, 5.5, 6, 6.5, 7, 8, 9, 10, 11, 12, 13 mm;
1/4" (6.3 mm)

No.	pcs	box
58160	16	20

PL Komplet nasadek z akcesoriami
GB Socket set
D Sechskantenschlüssel-Einsatz
RUS Набор торцевых головок

CZ Sada nástrčných kľučí a ráčny
RO Trusă de scule
H Dugókulcs készlet racsnis hajtókarral
E Juego de boquillas con accesorios



1/2" (12.7 mm); 1/2" (12.7 mm) x 240 mm; 1/2" (12.7 mm): 8, 9, 10, 11, 12, 13, 14, 15, 16, 17, 18, 19, 20, 21, 22, 23, 24, 27, 30 mm; 1/2" (12.7 mm) x 21 mm; 1/2" (12.7 mm) x 250 mm; 1/2" (12.7 mm) x 125 mm

No.	pcs	box
58240	24	5

PL Komplet nasadek z akcesoriami
GB Socket set
D Sechskantenschlüssel-Einsatz
RUS Набор торцевых головок

CZ Sada nástrčných kľučí a ráčny
RO Trusă de scule
H Dugókulcs készlet racsnis hajtókarral
E Juego de boquillas con accesorios



1/4" (6.3 mm) x 125 mm; 1/2" (12.7 mm) x 250 mm; 1/4" (6.3 mm): 4, 4.5, 5, 5.5, 6, 7, 8, 9, 10, 11, 13 mm; 1/2" (12.7 mm): 10, 11, 12, 13, 14, 15, 16, 17, 18, 19, 22, 27, 30 mm; 1/2" (12.7 mm) x 21 mm;
1/4" (6.3 mm) x 110 mm; 1/2" (12.7 mm) x 250 mm; 1/4" (6.3 mm) x 6 mm; 1/4" (6.3 mm) x 75 mm; 1/2" (12.7 mm) x 125 mm; 1/2" (12.7 mm) x 250 mm; 1/4" (6.3 mm) x 140 mm;
1/4" (6.3 mm); 1/2" (12.7 mm); 1/4" (6.3 mm): 3, 4, 5, 6, 7, 8 mm; 4; 5.5; 7 mm; PH1; PH2; PH3; 1.5; 2; 2.5 mm

No.	pcs	box
58520	52	5

PL Komplet nasadek z grzechotką
GB Ratchet handle with socket set
D Sechskant-Steckschlüssel-Satz
RUS Трещотка с насадками

CZ Sada nástrčných klíčů a ráčny
RO Trusă de scule
H Dugókulcs készlet racsnis hajtókarral
E Matraca con boquillas

11 PCS 72T
CrV



No.	mm	L (mm)	size / rozmiar	☐
58600	5; 6; 7; 8; 9; 10; 11; 12; 13; 14	150	1/4" (6.3 mm)	6/24
58602	10; 11; 12; 13; 14; 15; 17; 19; 22; 24	260	1/2" (12.7 mm)	12

PL Komplet nasadek z grzechotką
GB Ratchet handle with socket set
D Sechskant-Steckschlüssel-Satz
RUS Трещотка с насадками

CZ Sada nástrčných klíčů a ráčny
RO Trusă de scule
H Dugókulcs készlet racsnis hajtókarral
E Matraca con boquillas

19 PCS 1/2" 12.5mm
45T AS-DRIVE



1/2" (12.7 mm): 8, 9, 10, 11, 12, 13, 14, 15, 16, 17, 19, 21, 22, 23, 24, 27, 30, 32 mm;
1/2" (12.7 mm): 45T



No.	pcs	☐
58634	19	4/8

PL Komplet nasadek z akcesoriami
GB Socket set
D Sechskant-Steckschlüssel-Einsatz
RUS Набор торцевых головок
CZ Sada nástrčných klíčů a ráčny
RO Trusă de scule
H Dugókulcs készlet racsnis hajtókarral
E Juego de boquillas con accesorios

20 PCS 3/4" 19mm



3/4" (19.0 mm) x 495 mm; 3/4" (19.0 mm) x 100; 200 mm; 3/4" (19.0 mm): 22, 24, 26, 27, 28, 30, 32, 34, 36, 38, 41, 42, 45, 46, 48, 50 mm; 3/4" (19.0 mm) x 456 mm

No.	pcs	☐
58150	20	2

PL Komplet nasadek z akcesoriami
GB Socket set
D Sechskantenschlüssel-Einsatz
RUS Набор торцевых головок

CZ Sada nástrčných klíčů a ráčny
RO Trusă de scule
H Dugókulcs készlet racsnis hajtókarral
E Juego de boquillas con accesorios

12 PCS 1/2" 12.5mm
45T AS-DRIVE



1/2" (12.7 mm): 10, 11, 12, 13, 14, 15, 17, 19, 21, 24 mm; 1/2" (12.7 mm); 45T



No.	pcs	☐
58633	12	5/10

PL Komplet nasadek z akcesoriami
GB Socket set
D Sechskantenschlüssel-Einsatz
RUS Набор торцевых головок

CZ Sada nástrčných klíčů a ráčny
RO Trusă de scule
H Dugókulcs készlet racsnis hajtókarral
E Juego de boquillas con accesorios

14 PCS 3/4" 19mm



3/4" (19.0 mm) x 495 mm; 3/4" (19.0 mm) x 100; 200 mm; 3/4" (19.0 mm): 22, 24, 27, 30, 32, 36, 38, 41, 46, 50 mm; 3/4" (19.0 mm) x 456 mm

No.	size / rozmiar	pcs	☐
58140	3/4" (19.0 mm)	14	2

PL Zestaw narzędziowy
GB Tool set
D Sechskant-Steckschlüssel-Einsatz
RUS Набор торцевых головок

CZ Sada nástrčných klíčů a ráčny
RO Trusă de scule
H Dugókulcs készlet racsnis hajtókarral
E Juego de herramientas

38 PCS 1/4" 6.3mm
45T AS-DRIVE



1/4" (6.3 mm): 3.5, 4, 4.5, 5, 5.5, 6, 7, 8, 9, 10, 11, 12, 13, 14 mm; 1/4" (6.3 mm); 1/4" (6.3 mm); 1/4" (6.3 mm); 45T; 1/4" (6.3 mm); 1/4" (6.3 mm): 4, 5.5, 6.5 mm; 1/4" (6.3 mm): PH1, PH2; 1/4" (6.3 mm): PZ1, PZ2; 1/4" (6.3 mm): T10, T15, T20, T25, T30, T40; 1/4" (6.3 mm): 3, 4, 5, 6, 8 mm



No.	pcs	☐
58640	38	10

PL Zestaw narzędziowy
GB Tool set
D Sechskant-Steckschlüssel-Satz
RUS Набор торцовых головок

CZ Sada nástrčných klíčů a ráčny
RO Trusă de scule
H Dugókulcs készlet racsnis hajtókarral
E Juego de herramientas

42
PCS

1/4"
6.3mm

45T

AS-DRIVE



1/4" (6.3 mm): 4, 4.5, 5, 5.5, 6, 7, 8, 9, 10, 11, 12, 13, 14 mm; 1/4" (6.3 mm): 8, 9, 10, 11, 12, 13 mm;
1/4" (6.3 mm) x2; 1/4" (6.3 mm); 1/4" (6.3 mm); 1/4" (6.3 mm); 1/4" (6.3 mm); 45T;
1/4" (6.3 mm); 1/4" (6.3 mm) x 1/4" (6.3 mm); 1/4" (6.3 mm); 3, 4, 5 mm; 1/4" (6.3 mm): PH0, PH1, PH2; 1/4" (6.3 mm): PZ0, PZ1, PZ2; 1/4" (6.3 mm): 6, 7, 8 mm; 1.5, 2.0, 2.5 mm

STHOR

No.	pcs	Icon
58641	42	

PL Zestaw narzędziowy
GB Tool set
D Sechskant-Steckschlüssel-Satz
RUS Набор торцовых головок

CZ Sada nástrčných klíčů a ráčny
RO Trusă de scule
H Dugókulcs készlet racsnis hajtókarral
E Juego de herramientas

22
PCS

3/8"
10mm

45T

AS-DRIVE



3/8" (9.5 mm): 6, 7, 8, 9, 10, 11, 12, 13, 14, 15, 16, 17, 18, 19, 20, 21, 22 mm; 3/8" (9.5 mm); 3/8" (9.5 mm); 3/8" (9.5 mm); 45T

STHOR

No.	pcs	Icon
58661	22	

PL Zestaw narzędziowy
GB Tool set
D Sechskant-Steckschlüssel-Satz
RUS Набор инструментов

CZ Sada nástrčných klíčů a ráčny
RO Trusă de scule
H Dugókulcs készlet racsnis hajtókarral
E Juego de herramientas

82
PCS

1/2"
12.5mm

1/4"
6.3mm

45T

AS-DRIVE



STHOR

No.	pcs	Icon
58689	82	

PL Zestaw narzędziowy
GB Tool set
D Sechskant-Steckschlüssel-Satz
RUS Набор инструментов

CZ Sada nástrčných klíčů a ráčny
RO Trusă de scule
H Dugókulcs készlet racsnis hajtókarral
E Juego de herramientas

56
PCS

1/4"
6.3mm

45T

AS-DRIVE

CrV
50BV30



1/4" (6.3 mm): 4, 4.5, 5, 5.5, 6, 7, 8, 9, 10, 11, 12, 13 mm; 1/4" (6.3 mm): 6, 7, 8, 9, 10, 11, 12, 13 mm;
1/4" (6.3 mm): E4, E5, E6, E7, E8, E10; CrV 6150; 1/4" (6.3 mm) x2; 1/4" (6.3 mm); 1/4" (6.3 mm); 1/4" (6.3 mm); 1/4" (6.3 mm); 45T;
1/4" (6.3 mm); 1/4" (6.3 mm) (F) x 3/8" (9.5 mm) (M); 1/4" (6.3 mm): 4, 5, 5.5, 6.5 mm; 1/4" (6.3 mm): PH1, PH2, PH3; 1/4" (6.3 mm): PZ1, PZ2, PZ3; 1/4" (6.3 mm): T8, T10, T15, T20, T25, T30, T40; 1/4" (6.3 mm): 3, 4, 5, 7, 6, 8 mm

STHOR

No.	pcs	Icon
58643	56	

PL Zestaw narzędziowy
GB Tool set
D Sechskant-Steckschlüssel-Satz
RUS Набор торцовых головок

CZ Sada nástrčných klíčů a ráčny
RO Trusă de scule
H Dugókulcs készlet racsnis hajtókarral
E Juego de herramientas

72
PCS

1/2"
12.5mm

1/4"
6.3mm

CrV
6140

45T

AS-DRIVE



1/2" (12.7 mm): 10, 11, 12, 13, 14, 15, 16, 17, 18, 19, 20, 21, 22, 23, 24, 27 mm; 1/4" (6.3 mm): 4, 5, 6, 7, 8, 9, 10, 11, 12, 13 mm; 1/2" (12.7 mm) x2; 1/4" (6.3 mm); 3/8" (9.5 mm) (F) x 1/2" (12.7 mm) (M); 1/2" (12.7 mm); 1/2" (12.7 mm); 21 mm; 1/2" (12.7 mm); 1/4" (6.3 mm); 45T;
1/4" (6.3 mm); 1/4" (6.3 mm) x 1/4" (6.3 mm); 1/4" (6.3 mm): 4, 5, 5.5, 6, 7 mm; CrV 6140; 1/4" (6.3 mm): PH0, PH1, PH2, PH3; CrV 6140; 1/4" (6.3 mm): PZ0, PZ1, PZ2, PZ3; CrV 6140; 1/4" (6.3 mm): T8, T9, T10, T15, T20, T25, T27, T30, T40; CrV 6140; 1/4" (6.3 mm): 3, 4, 5, 6, 7, 8 mm; CrV 6140; 1/4" (6.3 mm): S0, S1, S2, S3; CrV 6140; 1.25, 1.5, 2.5, 3 mm

STHOR

No.	pcs	Icon
58705	72	

PL Zestaw narzędziowy
GB Tool set
D Sechskant-Steckschlüssel-Satz
RUS Набор инструментов

CZ Sada nástrčných klíčů a ráčny
RO Trusă de scule
H Dugókulcs készlet racsnis hajtókarral
E Juego de herramientas

82
PCS

1/2"
12.5mm

1/4"
6.3mm

45T

AS-DRIVE



1/2" (12.7 mm): 14, 15, 16, 17, 18, 19, 20, 22, 24, 27, 30, 32 mm; 1/4" (6.3 mm): 4, 4.5, 5, 5.5, 6, 7, 8, 9, 10, 11, 12, 13, 14 mm; 1/2" (12.7 mm) x2; 1/4" (6.3 mm) x2; 1/4" (6.3 mm); 3/8" (9.5 mm) (F) x 1/2" (12.7 mm) (M); 1/2" (12.7 mm); 1/4" (6.3 mm); 1/2" (12.7 mm); 16, 21 mm; 1/4" (6.3 mm); 1/2" (12.7 mm); 1/4" (6.3 mm); 72T; 1/4" (6.3 mm); 1/4" (6.3 mm) x 1/4" (6.3 mm); 1/2" (12.7 mm) x 5/16" (7.9 mm); 5/16" (7.9 mm): 8, 10, 12 mm; 5/16" (7.9 mm): PH3, PH4; 5/16" (7.9 mm): PZ3, PZ4; 5/16" (7.9 mm): T40, T45, T50, T55; 5/16" (7.9 mm): 8, 10, 12, 14 mm; 1/4" (6.3 mm): 4, 5.5, 7 mm; 1/4" (6.3 mm): PH1, PH2; 1/4" (6.3 mm): PZ1, PZ2; 1/4" (6.3 mm): T8, T10, T15, T20, T25, T30; 1/4" (6.3 mm): 3, 4, 5, 6 mm; 8, 10, 11, 12, 13, 14, 17, 19, 22 mm

PL Zestaw narzędziowy
GB Tool set
D Sechskant-Steckschlüssel-Satz
RUS Набор инструментов
CZ Sada nástrčných klíčů a ráčny
RO Trusă de scule
H Dugókulcs készlet racsnis hajtókarral
E Juego de herramientas

94 PCS	1/2" 12.5mm	1/4" 6.3mm
45T	AS-DRIVE	



1/2" (12.7 mm): 10, 11, 12, 13, 14, 15, 16, 17, 18, 19, 20, 21, 22, 23, 24, 27, 30, 32; 1/4" (6.3 mm): 4, 4.5, 5, 5.5, 6, 7, 8, 9, 10, 11, 12, 13, 14 mm; 1/2" (12.7 mm): 14, 15, 17, 19 mm; 1/4" (6.3 mm): 6, 7, 8, 9, 10, 11, 12, 13 mm; 1/2" (12.7 mm) x2; 1/4" (6.3 mm) x2; 3/8" (9.5 mm) (F) x 1/2" (12.7 mm) (M); 1/4" (6.3 mm); 1/2" (12.7 mm); 1/4" (6.3 mm); 1/2" (12.7 mm): 16, 21 mm; 1/4" (6.3 mm); 1/2" (12.7 mm); 1/4" (6.3 mm); 45T; 1/4" (6.3 mm); 1/2" (12.7 mm) x 5/16" (7.9 mm); 1/4" (6.3 mm) x 1/4" (6.3 mm); 5/16" (7.9 mm): 8, 10, 12 mm; 5/16" (7.9 mm): PH3, PH4; 5/16" (7.9 mm): PZ3, PZ4; 5/16" (7.9 mm): T40, T45, T50, T55; 5/16" (7.9 mm): 8, 10, 12, 14 mm; 1/4" (6.3 mm): 4, 5.5, 7 mm; 1/4" (6.3 mm): PZ1, PZ2; 1/4" (6.3 mm): PH1, PH2; 1/4" (6.3 mm): T8, T10, T15, T20, T25, T30; 1/4" (6.3 mm): 3, 4, 5, 6 mm; 1.5, 2, 2.5 mm



No.	pcs	
58687	94	3

PL Zestaw narzędziowy
GB Tool set
D Sechskant-Steckschlüssel-Satz
RUS Набор инструментов
CZ Sada nástrčných klíčů a ráčny
RO Trusă de scule
H Dugókulcs készlet racsnis hajtókarral
E Juego de herramientas

111 PCS	1/2" 12.5mm	3/8" 10mm	1/4" 6.3mm
CrV 6140	45T	AS-DRIVE	



1/2" (12.7 mm): 14, 15, 16, 17, 18, 19, 20, 21, 22, 23, 24, 27, 30, 32 mm; 3/8" (9.5 mm): 9, 10, 11, 12, 13, 14, 15, 16, 17, 18, 19 mm; 1/4" (6.3 mm): 3.5, 4, 4.5, 5, 5.5, 6, 7, 8, 9, 10, 11, 12, 13 mm; 1/2" (12.7 mm) x2; 3/8" (9.5 mm) x2; 1/4" (6.3 mm) x2; 3/8" (9.5 mm) (F) x 1/2" (12.7 mm) (M); 1/2" (12.7 mm) (F) x 3/8" (9.5 mm) (M); 3/8" (9.5 mm) (F) x 1/4" (6.3 mm) (M); 1/2" (12.7 mm); 1/4" (6.3 mm); 1/2" (12.7 mm): 16, 21 mm; 3/8" (9.5 mm): 16, 21 mm; 1/2" (12.7 mm); 3/8" (9.5 mm); 1/4" (6.3 mm); 45T; 1/4" (6.3 mm); 1/2" (12.7 mm) x 5/16" (7.9 mm); 3/8" (9.5 mm) x 5/16" (7.9 mm); 5/16" (7.9 mm): 6, 6.5, 8 mm; CrV 6140; 5/16" (7.9 mm): PH2, PH3; CrV 6140; 5/16" (7.9 mm): PZ2, PZ3; CrV 6140; 5/16" (7.9 mm): T27, T30, T35, T40, T45; CrV 6140; 5/16" (7.9 mm): 5.5, 6, 6.5 mm; CrV 6140; 1/4" (6.3 mm): 4, 5.5, 6.5 mm; CrV 6140; 1/4" (6.3 mm): PH1, PH2; CrV 6140; 1/4" (6.3 mm): PZ1, PZ2; CrV 6140; 1/4" (6.3 mm): T8, T10, T15, T20, T25; CrV 6140; 1/4" (6.3 mm): T10, T15, T20, T25, T40; CrV 6140; 1/4" (6.3 mm): T8, T10, T15, T20, T25; CrV 6140; 1/4" (6.3 mm): 3, 4, 5, 6 mm; CrV 6140; 8, 9, 10, 11, 12, 13, 14, 15, 16, 17, 18, 19 mm; 1.5, 2, 2.5 mm



No.	pcs	
58692	111	1

PL Zestaw narzędziowy
GB Tool set
D Sechskant-Steckschlüssel-Satz
RUS Набор инструментов
CZ Sada nástrčných klíčů a ráčny
RO Trusă de scule
H Dugókulcs készlet racsnis hajtókarral
E Juego de herramientas

108 PCS	1/2" 12.5mm	1/4" 6.3mm	CrV 50BV30
45T	AS-DRIVE		



1/2" (12.7 mm): 10, 11, 12, 13, 14, 15, 16, 17, 18, 19, 20, 21, 22, 24, 27, 30, 32 mm; 1/4" (6.3 mm): 4, 4.5, 5, 5.5, 6, 7, 8, 9, 10, 11, 12, 13, 14 mm; 1/2" (12.7 mm): 14, 15, 17, 19, 22 mm; 1/4" (6.3 mm): 6, 7, 8, 9, 10, 11, 12, 13 mm; 1/2" (12.7 mm): E10, E11, E12, E14, E16, E18, E20, E24; 1/4" (6.3 mm): E4, E5, E6, E7, E8; CrV 50BV30; 1/2" (12.7 mm) x2; 1/4" (6.3 mm) x2; 3/8" (9.5 mm) (F) x 1/2" (12.7 mm) (M); 1/2" (12.7 mm); 1/4" (6.3 mm); 1/2" (12.7 mm): 16, 21 mm; 1/4" (6.3 mm); 1/2" (12.7 mm); 1/4" (6.3 mm); 45T; 1/4" (6.3 mm); 1/2" (12.7 mm) x 5/16" (7.9 mm) (F); 1/4" (6.3 mm) x 1/4" (6.3 mm); 5/16" (7.9 mm): 8, 10, 12 mm; 5/16" (7.9 mm): PH3, PH4; 5/16" (7.9 mm): PZ3, PZ4; 5/16" (7.9 mm): T40, T45, T50, T55, T60; 5/16" (7.9 mm): 7, 8, 10, 12, 14 mm; 1/4" (6.3 mm): 4, 5.5, 6.5 mm; 1/4" (6.3 mm): PH1, PH2; 1/4" (6.3 mm): PZ1, PZ2; 1/4" (6.3 mm): T8, T10, T15, T20, T25, T27, T30; 1/4" (6.3 mm): 3, 4, 5, 6; 1.5, 2, 2.5 mm



No.	pcs	
58685	108	3

PL Zestaw narzędziowy
GB Tool set
D Sechskant-Steckschlüssel-Satz
RUS Набор инструментов
CZ Sada nástrčných klíčů a ráčny
RO Trusă de scule
H Dugókulcs készlet racsnis hajtókarral
E Juego de herramientas

122 PCS	1/2" 12.5mm	1/4" 6.3mm	CrV 50BV30
CrV 6150	45T	AS-DRIVE	



1/2" (12.7 mm): 12, 13, 14, 15, 16, 17, 18, 19, 20, 21, 22, 24, 27, 30, 32 mm; 1/4" (6.3 mm): 4, 4.5, 5, 5.5, 6, 7, 8, 9, 10, 11, 12, 13, 14 mm; 1/2" (12.7 mm): 10, 12, 13, 14, 17, 19 mm; 1/4" (6.3 mm): 4, 5, 6, 7, 8, 9 mm; 1/2" (12.7 mm): E10, E12, E14, E16, E18, E20, E22, E24; CrV 50BV30; 1/2" (12.7 mm); 1/4" (6.3 mm); 3/8" (9.5 mm) (F) x 1/2" (12.7 mm) (M); 3/8" (9.5 mm) (F) x 1/4" (6.3 mm) (M); 1/2" (12.7 mm); 1/4" (6.3 mm); 1/2" (12.7 mm): 16, 21 mm; 1/2" (12.7 mm); 1/4" (6.3 mm); 45T; 1/4" (6.3 mm); 1/4" (6.3 mm) x 1/4" (6.3 mm); 1/4" (6.3 mm): 3, 4, 5, 6 mm; 1/4" (6.3 mm): PH0, PH1, PH2; 1/4" (6.3 mm): PZ0, PZ1, PZ2; 1/4" (6.3 mm): 4.0, 5.5, 6.5 mm; 1/4" (6.3 mm): PH1, PH2, PH3; 1/4" (6.3 mm): PZ2, PZ3; 1/4" (6.3 mm): T8, T10, T15, T20, T25; 1/4" (6.3 mm): T10, T15, T20, T25, T40; 1/4" (6.3 mm): 3, 4, 5, 6 mm; 8, 9, 10, 11, 12, 13, 14, 15, 16, 17, 18, 19 mm; 4x100, 6.5x150, PH2x100, PH3x150 mm; CrV 6150; 160 mm; 160 mm; 180 mm; 250 mm; 300 g; 2, 2.5, 3, 4, 5, 6, 7, 8, 10 mm



No.	pcs	
58690	122	2

PL Zestaw narzędziowy
 GB Tool set
 D Sechskant-Steckschlüssel-Satz
 RUS Набор инструментов
 CZ Sada nástrčných klíčů a ráčny
 RO Trusă de scule
 H Dugókulcs készlet racsnis hajtókarral
 E Juego de herramientas

173 PCS	1/2" 12.5mm	3/8" 10mm	1/4" 6.3mm
CrV 50BV30	45T	AS-DRIVE	



1/2" (12.7 mm): 10, 11, 12, 13, 14, 15, 16, 17, 18, 19, 20, 21, 22, 23, 24, 27, 30, 32 mm; 3/8" (9.5 mm): 10, 11, 12, 13, 14, 15, 16, 17, 18, 19 mm; 1/4" (6.3 mm): 4, 4.5, 5, 5.5, 6, 7, 8, 9, 10, 11, 12, 13, 14 mm; 1/2" (12.7 mm): 16, 17, 18, 19, 22 mm; 3/8" (9.5 mm): 10, 11, 12, 13, 14, 15 mm; 1/4" (6.3 mm): 4, 5, 6, 7, 8, 9, 10 mm; 1/2" (12.7 mm): E18, E20, E24; 3/8" (9.5 mm): E10, E11, E12, E14, E16, E18; 1/4" (6.3 mm): E4, E5, E6, E7, E8; CrV 50BV30; 1/2" (12.7 mm) x2; 3/8" (9.5 mm); 1/4" (6.3 mm) x2; 3/8" (9.5 mm) (F) x 1/2" (12.7 mm) (M); 1/2" (12.7 mm); 3/8" (9.5 mm); 1/4" (6.3 mm); 1/2" (12.7 mm): 16, 21 mm; 3/8" (9.5 mm): 18 mm; 1/2" (12.7 mm); 1/4" (6.3 mm); 1/2" (12.7 mm); 3/8" (9.5 mm); 1/4" (6.3 mm); 45T; 1/4" (6.3 mm); 1/2" (12.7 mm) x 5/16" (7.9 mm); 3/8" (9.5 mm) x 5/16" (7.9 mm); 1/4" (6.3 mm) x 1/4" (6.3 mm); 5/16" (7.9 mm): 8, 10, 12 mm; 5/16" (7.9 mm): PH3, PH4; 5/16" (7.9 mm): PZ3, PZ4; 5/16" (7.9 mm): T40, T45, T50, T55, T60, T70; 5/16" (7.9 mm): T40, T45, T50, T55, T60, T70; 5/16" (7.9 mm): 7, 8, 10, 12, 14 mm; 1/4" (6.3 mm): T5, T6, T7; 1/4" (6.3 mm): T7, T10, T15, T20, T25, T27, T30, T40, T45; 1/4" (6.3 mm): M5, M6, M8; 1/4" (6.3 mm): RM5, RM6, RM7, RM8, RM9; 1/4" (6.3 mm): 4, 5, 5.5, 6, 5, 7 mm; 1/4" (6.3 mm): PH0, PH1, PH2; 1/4" (6.3 mm): PZ0, PZ1, PZ2; 1/4" (6.3 mm): T8, T9, T10, T15, T20, T25, T27, T30; 1/4" (6.3 mm): T8, T9, T10, T15, T20, T25, T27, T30; 1/4" (6.3 mm): 3, 4, 5, 6 mm; 1.25, 1.5, 2, 2.5, 3, 4, 5 mm



No.	pcs	
58688	173	1

PL Zestaw narzędziowy
 GB Tool set
 D Sechskant-Steckschlüssel-Satz
 RUS Набор инструментов
 CZ Sada nástrčných klíčů a ráčny
 RO Trusă de scule
 H Dugókulcs készlet racsnis hajtókarral
 E Juego de herramientas

1/2" (12.7 mm): 10, 11, 12, 13, 14, 15, 17, 19, 20, 21, 22, 24, 27, 30, 32 mm; 3/8" (9.5 mm): 10, 11, 12, 13, 14, 15, 16, 17, 18, 19 mm; 1/4" (6.3 mm): 4, 4.5, 5, 5.5, 6, 7, 8, 9, 10, 11, 12, 13, 14 mm; 1/2" (12.7 mm): 16, 17, 18, 19, 22 mm; 3/8" (9.5 mm): 10, 11, 12, 13, 14, 15 mm; 1/4" (6.3 mm): 4, 5, 6, 7, 8, 9, 10 mm; 1/2" (12.7 mm): E20, E22, E24; 3/8" (9.5 mm): E10, E11, E12, E14, E16, E18; 1/4" (6.3 mm): E4, E5, E6, E7, E8; CrV 50BV30; 1/2" (12.7 mm) x2; 3/8" (9.5 mm); 1/4" (6.3 mm) x2; 1/2" (12.7 mm); 3/8" (9.5 mm); 1/4" (6.3 mm); 1/2" (12.7 mm): 16, 21 mm; 3/8" (9.5 mm): 18 mm; 1/2" (12.7 mm); 1/4" (6.3 mm); 1/2" (12.7 mm); 3/8" (9.5 mm); 1/4" (6.3 mm); 45T; 1/4" (6.3 mm); 1/2" (12.7 mm) x 5/16" (7.9 mm); 3/8" (9.5 mm) x 5/16" (7.9 mm); 1/4" (6.3 mm) x 1/4" (6.3 mm); 5/16" (7.9 mm): 6, 6.5, 8 mm; 1/4" (6.3 mm): 4, 5.5, 6.5 mm; 5/16" (7.9 mm): PH3, PH4; 1/4" (6.3 mm): PH1, PH2; 5/16" (7.9 mm): PZ3, PZ4; 1/4" (6.3 mm): PZ1, PZ2; 5/16" (7.9 mm): T25, T27, T30, T35, 2xT40, T45, T50; 1/4" (6.3 mm): T8, T10, T15, T20, T25; 5/16" (7.9 mm): T27, T30, T35, T40, T45, T50; 1/4" (6.3 mm): T8, 2xT10, 2xT15, 2xT20, 2xT25, T40; 5/16" (7.9 mm): 5.5, 6, 6.5, 7, 8 mm; 1/4" (6.3 mm): 3, 4, 5, 6 mm; 1/4" (6.3 mm): M5, M6, M8, M10; 1/4" (6.3 mm): M5, M6, M8; 1/4" (6.3 mm): S1, S2; 1/4" (6.3 mm): 1, 2, 3 mm; 1/4" (6.3 mm): 6, 8, 10 mm; 1/4" (6.3 mm): 4, 6, 8 mm; 1/4" (6.3 mm): 6, 6.5, 8 mm; 1/4" (6.3 mm): PH3, PH4; 1/4" (6.3 mm): PZ3, PZ4; 1/2" (12.7 mm): T55, T60; 1/4" (6.3 mm): T25, T27, T30, T35, 2xT40, T45, T50; 1/4" (6.3 mm): T27, T30, T35, T40, T45, T50; 1/4" (6.3 mm): 5.5, 6, 6.5, 7, 8 mm; 1/4" (6.3 mm): M5, M6, M8, M10; 8, 10, 11, 12, 13, 14, 15, 16, 17, 18, 19, 22 mm; 1.27, 1.5, 2, 2.5, 3, 4, 5 mm



No.	pcs	
58691	216	1

PL Zestaw narzędziowy
 GB Tool set
 D Sechskant-Steckschlüssel-Satz
 RUS Набор инструментов
 CZ Sada nástrčných klíčů a ráčny
 RO Trusă de scule
 H Dugókulcs készlet racsnis hajtókarral
 E Juego de herramientas

216 PCS	1/2" 12.5mm	3/8" 10mm	1/4" 6.3mm	CrV 50BV30
CrV 6140	45T	AS-DRIVE		

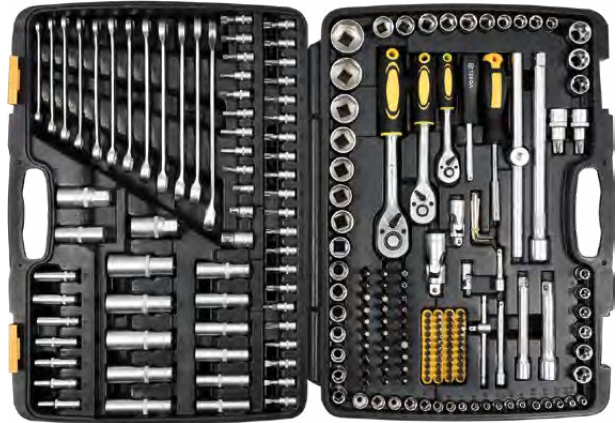

1/2" (12.7 mm): 10, 11, 12, 13, 14, 15, 17, 19, 20, 21, 22, 24, 27, 30, 32 mm; 3/8" (9.5 mm): 10, 11, 12, 13, 14, 15, 16, 17, 18, 19 mm; 1/4" (6.3 mm): 4, 4.5, 5, 5.5, 6, 7, 8, 9, 10, 11, 12, 13, 14 mm; 1/2" (12.7 mm): 16, 17, 18, 19, 22 mm; 3/8" (9.5 mm): 10, 11, 12, 13, 14, 15 mm; 1/4" (6.3 mm): 4, 5, 6, 7, 8, 9, 10 mm; 1/2" (12.7 mm): E20, E22, E24; 3/8" (9.5 mm): E10, E11, E12, E14, E16, E18; 1/4" (6.3 mm): E4, E5, E6, E7, E8; CrV 50BV30; 1/2" (12.7 mm) x2; 3/8" (9.5 mm); 1/4" (6.3 mm) x2; 1/2" (12.7 mm); 3/8" (9.5 mm); 1/4" (6.3 mm); 1/2" (12.7 mm): 16, 21 mm; 3/8" (9.5 mm): 18 mm; 1/2" (12.7 mm); 1/4" (6.3 mm); 1/2" (12.7 mm); 3/8" (9.5 mm); 1/4" (6.3 mm); 45T; 1/4" (6.3 mm); 1/2" (12.7 mm) x 5/16" (7.9 mm); 3/8" (9.5 mm) x 5/16" (7.9 mm); 1/4" (6.3 mm) x 1/4" (6.3 mm); 5/16" (7.9 mm): 6, 6.5, 8 mm; 1/4" (6.3 mm): 4, 5.5, 6.5 mm; CrV 6140; 5/16" (7.9 mm): PH3, PH4; 1/4" (6.3 mm): PH1, PH2; CrV 6140; 5/16" (7.9 mm): PZ3, PZ4; 1/4" (6.3 mm): PZ1, PZ2; CrV 6140; 5/16" (7.9 mm): T25, T27, T30, T35, 2xT40, T45, T50; 1/4" (6.3 mm): T8, T10, T15, T20, T25; CrV 6140; 5/16" (7.9 mm): T27, T30, T35, T40, T45, T50; 1/4" (6.3 mm): T8, 2xT10, 2xT15, 2xT20, 2xT25, T40; CrV 6140; 5/16" (7.9 mm): 5.5, 6, 6.5, 7, 8 mm; 1/4" (6.3 mm): 3, 4, 5, 6 mm; CrV 6140; 1/4" (6.3 mm): 3, 4, 5, 6 mm; CrV 6140; 5/16" (7.9 mm): M5, M6, M8, M10; 1/4" (6.3 mm): M5, M6, M8; CrV 6140; 1/4" (6.3 mm): S1, S2; CrV 6140; 1/4" (6.3 mm): 1, 2, 3 mm; CrV 6140; 1/4" (6.3 mm): 6, 8, 10 mm; CrV 6140; 1/4" (6.3 mm): 4, 6, 8 mm; CrV 6140; 1/4" (6.3 mm): 6, 6.5, 8 mm; CrV 6140; 1/4" (6.3 mm): PH3, PH4; CrV 6140; 1/4" (6.3 mm): PZ3, PZ4; CrV 6140; 1/2" (12.7 mm): T55, T60; 1/4" (6.3 mm): T25, T27, T30, T35, 2xT40, T45, T50; CrV 6140; 1/4" (6.3 mm): T27, T30, T35, T40, T45, T50; CrV 6140; 1/4" (6.3 mm): 5.5, 6, 6.5, 7, 8 mm; CrV 6140; 1/4" (6.3 mm): M5, M6, M8, M10; CrV 6140; 8, 10, 11, 12, 13, 14, 15, 16, 17, 18, 19, 22 mm; 1.27, 1.5, 2, 2.5, 3, 4, 5 mm



No.	pcs	
58700	216	1

216 PCS	1/2" 12.5mm	3/8" 10mm	1/4" 6.3mm	CrV 50BV30	45T	AS-DRIVE	
-------------------	-----------------------	---------------------	----------------------	----------------------	------------	-----------------	--



PL Zestaw narzędziowy CZ Sada nástrčných kľúčů a rúčny
 GB Tool set RO Trusă de scule
 D Sechskant-Steckschlüssel-Satz H Dugókulcs készlet racsfnis hajtókarral
 RUS Набор инструментов E Juego de herramientas

225 PCS 1/2" 12.5mm 3/8" 10mm 1/4" 6.3mm
 CrV 6140 45T AS-DRIVE METRIC & S.A.E.

2



1/2" (12.7 mm): 10, 13, 15, 16, 17, 18, 19, 20, 21, 22, 23, 24, 27, 30, 32 mm; 3/8" (9.5 mm): 10, 11, 12, 13, 14, 15, 16, 17, 18, 19 mm; 1/4" (6.3 mm): 3.5, 4, 4.5, 5, 5.5, 6, 7, 8, 9, 10, 11, 12, 13, 14 mm; 1/2" (12.7 mm): 10, 11, 12, 13, 14, 15, 17, 19, 21 mm; 3/8" (9.5 mm): 6, 7, 8, 9, 10 mm; 1/2" (12.7 mm): 7/16" (11.1 mm), 1/2" (12.7 mm), 9/16" (14.3 mm), 5/8" (15.9 mm), 11/16" (17.5 mm), 3/4" (19.0 mm), 13/16" (20.6 mm), 7/8" (22.2 mm); 1/4" (6.3 mm): 1/4" (6.3 mm), 9/32" (7.1 mm), 5/16" (7.9 mm), 11/32" (8.7 mm), 3/8" (9.5 mm); 1/2" (12.7 mm): 17, 19, 21 mm; 1/2" (12.7 mm): E16, E18, E20, E22, E24; 3/8" (9.5 mm): E10, E11, E12, E14; 1/4" (6.3 mm): E4, E5, E6, E7, E8; 1/2" (12.7 mm) x2, 3/8" (9.5 mm) x2, 1/4" (6.3 mm) x2; 3/8" (9.5 mm) (F) x 1/2" (12.7 mm) (M), 1/2" (12.7 mm) (F) x 3/8" (9.5 mm) (M); 1/2" (12.7 mm), 3/8" (9.5 mm), 1/4" (6.3 mm); 1/2" (12.7 mm): 16, 21 mm, 3/8" (9.5 mm): 18 mm; 1/4" (6.3 mm); 1/2" (12.7 mm), 3/8" (9.5 mm), 1/4" (6.3 mm); 45T; 1/4" (6.3 mm); 1/4" (6.3 mm); 1/2" (12.7 mm) x 5/16" (7.9 mm), 3/8" (9.5 mm) x 5/16" (7.9 mm), 3/8" (9.5 mm) x 1/4" (6.3 mm), 1/4" (6.3 mm) x 1/4" (6.3 mm); 3/8" (9.5 mm) x 1/4" (6.3 mm), 1/4" (6.3 mm) x 1/4" (6.3 mm) x2; 1/4" (6.3 mm) x 1/4" (6.3 mm); 5/16" (7.9 mm): 8, 10 mm; 1/4" (6.3 mm): 3, 4, 5.5, 6.5, 7, 8, 9 mm; CrV 6140; 5/16" (7.9 mm): PH3, PH4; 1/4" (6.3 mm): PH0, PH1, PH2, PH3; CrV 6140; 5/16" (7.9 mm): PZ3, PZ4; 1/4" (6.3 mm): PZ0, PZ1, PZ2, PZ3; CrV 6140; 5/16" (7.9 mm): T20, T25, T27, T30, T40, T45, T50, T55 (L=75 mm); T40, T45, T50, T55, T60, T70 (L=30 mm); 1/4" (6.3 mm): T8, T9, T10, T15, T20, T25, T27, T30; 5/16" (7.9 mm): T40, T45, T50, T55, T60, T70; 1/4" (6.3 mm): T8, T9, T10, T15, T20, T25, T27, T30; CrV 6140; 5/16" (7.9 mm): 10, 12, 14 mm; 1/4" (6.3 mm): 3, 4, 5, 6, 7, 8 mm; CrV 6140; 1/4" (6.3 mm): 4, 5, 6, 7, 8 mm; CrV 6140; 1/4" (6.3 mm): M5, M6, M8, M10; CrV 6140; 1/4" (6.3 mm): S1, S2; CrV 6140; 1/4" (6.3 mm): 1, 2, 3, 4; CrV 6140; 1/4" (6.3 mm): 6, 8, 10; CrV 6140; 1/4" (6.3 mm): 4, 6, 8, 10 mm; CrV 6140; 8, 9, 10, 11, 12, 13, 14, 15, 16, 17, 19, 22 mm; 6x38, PH2x38; 180 mm; 250 mm; 2, 2.5, 3, 4, 5, 6, 7, 8, 10, 12 mm



No.	pcs	Icon
58693	225	1

Memo	
------	--

3

Screwdrivers & screwdriver bits Wkrętaki i końcówki wkrętakowe



Screwdrivers, 3 colour handle Wkrętaki, trójkolorowa rączka



26-28

Slotted screwdrivers

Wkrętaki płaskie..... 26

Phillips screwdrivers

Wkrętaki krzyżakowe..... 26

Pozidrive screwdrivers

Wkrętaki „Pozidrive”..... 26

Torx screwdrivers

Wkrętaki „Torx”..... 26

Screwdriver sets

Komplety wkrętaków..... 26

Ratchet screwdrivers

Wkrętaki z grzechotką..... 28

Go-through screwdrivers Wkrętaki do pobijania



28

Slotted screwdrivers

Wkrętaki płaskie..... 28

Phillips screwdrivers

Wkrętaki krzyżakowe..... 28

Screwdrivers HI-TEC & sets Wkrętaki HI-TEC i zestawy



28-30

Slotted screwdrivers

Wkrętaki płaskie..... 28

Phillips screwdrivers

Wkrętaki krzyżakowe..... 29

Torx screwdrivers

Wkrętaki „Torx”..... 30

Torx Security screwdrivers

Wkrętaki „Torx Security”..... 30

Screwdriver sets

Komplety wkrętaków..... 30

Special & impact screwdrivers Wkrętaki specjalne i udarowe

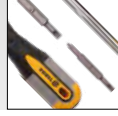

30-35

Two way screwdrivers

Wkrętaki dwustronne..... 30

Ratchet screwdriver sets with bits

Zestawy wkrętaków z grzechotką i bitami..... 31

Impact screwdrivers

Wkrętaki udarowe..... 34

Telescopic screwdrivers

Wkrętaki teleskopowe..... 35

T-bar screwdrivers

Wkrętaki T-gryf..... 35

Screwdriver sets Zestawy wkrętaków



35-36

Precision screwdrivers sets Zestawy wkrętaków precyzyjnych



37-38

Screwdriver bits Kończówki wkrętakowe



38-42

Screwdriver bit sets

Zestawy końcówek wkrętakowych..... 38

Screwdriver bit holders

Uchwyty do końcówek wkrętakowych..... 42

Nut setter sets

Zestawy nasadek magnetycznych do wkrętarek..... 42

Hex & Torx keys & sets Klucze imbusowe i zestawy



43-44

Hex keys

Klucze imbusowe „Hex”..... 43

Hex key sets

Zestawy kluczy imbusowych „Hex”..... 43

Torx & Torx Tamperproof key sets

Zestawy kluczy imbusowych „Torx”
i „Torx Tamperproof”..... 44

PL Wkrętak płaski
GB Slotted screwdriver
D Schraubendreher schlitz
RUS Отвёртка шлицевая

CZ Šroubovák
RO Şurubelniţă
H Csavarhúzó
E Destornillador



No.	mm	pcs packing	☐
60912	2x75	12	96/384
60950	3x75	12	96/384
60951	3x100	12	96/384
60952	4x100	12	96/384
60913	4x150	12	96/384
60914	4x200	12	60/240
60915	5x38	12	60/240
60953	5x75	12	60/240
60954	5x100	12	60/240
60955	5x150	12	60/240
60916	5x200	12	36/144
60917	6x38	12	60/240
60956	6x100	12	36/144
60957	6x150	12	36/144
60958	6x200	12	36/144
60959	8x150	6	24/96
60918	8x250	6	24/96

PL Wkrętak
GB Screwdriver
D Schraubendreher
RUS Отвёртка крестовая

CZ Šroubovák
RO Şurubelniţă
H Csavarhúzó
E Destornillador



No.	mm	pcs packing	☐
60931	PZ0x75	12	96/384
60932	PZ0x100	12	96/384
60933	PZ1x75	12	60/240
60934	PZ1x100	12	60/240
60935	PZ1x200	12	36/144
60936	PZ2x100	12	36/144
60937	PZ2x150	12	36/144
60938	PZ2x200	12	36/144
60939	PZ3x150	6	24/96

PL Komplet wkrętek
GB Screwdriver set
D Schraubendrehersatz
RUS Набор отвёрток
CZ Zámečnické šroubováky
RO Şurubelniţe de lăcătuşerie
H Lakatos csavarhúzó
E Juego de destornilladores



No.	pcs	☐
60970	10	6/24

PL Wkrętak krzyżakowy
GB Phillips screwdriver
D Kreuzschlitzschraubendreher
RUS Отвёртка крестовая

CZ Šroubovák křížový
RO Şurubelniţă în cruce
H Csavarhúzó kereszt
E Destornillador cruz



No.	mm	pcs packing	☐
60920	PH00x65	12	96/384
60961	PH0x75	12	96/384
60962	PH0x100	12	96/384
60921	PH1x38	12	60/240
60963	PH1x75	12	60/240
60964	PH1x100	12	60/240
60965	PH1x150	12	60/240
60922	PH1x250	12	36/144
60923	PH2x38	12	60/240
60966	PH2x100	12	36/144
60967	PH2x150	12	36/144
60968	PH2x200	12	36/144
60924	PH2x250	12	36/144
60969	PH3x150	6	24/96

PL Wkrętak
GB Screwdriver
D Schraubendreher
RUS Отвёртка

CZ Šroubovák
RO Şurubelniţă
H Csavarhúzó
E Destornillador



No.	mm	pcs packing	☐
60880	T5x75	12	96/384
60881	T6x75	12	96/384
60882	T7x75	12	96/384
60883	T8x75	12	96/384
60884	T9x75	12	96/384
60885	T10x100	12	60/240
60886	T15x100	12	60/240
60887	T20x100	12	60/240
60888	T25x100	12	36/144
60889	T27x100	12	36/144
60890	T30x100	12	36/144
60891	T40x100	6	24/96

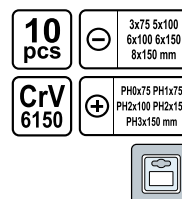

PL Komplet długich wkrętek
GB Screwdriver set
D Schraubendrehersatz
RUS Набор отверток
CZ Zámečnické šroubováky
RO Șurubelnițe de lăcătușerie
H Lakatos csavarhózó
E Juego de destornilladores

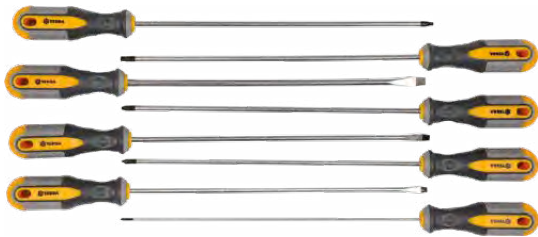
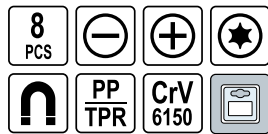

- ⊖ 5.5, 6.5, 8.0 mm (L=325 mm); CrV 6150;
- ⊕ PH0, PH1, PH2 (L=325 mm); CrV 6150;
- ⊗ T25, T30 (L=325 mm); CrV 6150



No.	pcs	☐
60990	8	10

PL Komplet wkrętek
GB Screwdriver set
D Schraubendrehersatz
RUS Набор отверток

CZ Zámečnické šroubováky
RO Șurubelnițe de lăcătușerie
H Lakatos csavarhózó
E Juego de destornilladores

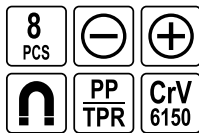

- ⊖ 3.0x75, 5.5x75, 6.5x38, 6.5x100 mm; CrV 6150;
- ⊕ PH0x75, PH1x75, PH2x38, PH2x100 mm; CrV 6150



No.	pcs	☐
60782	8	12/24

PL Komplet wkrętek
GB Screwdriver set
D Schraubendrehersatz
RUS Набор отверток
CZ Zámečnické šroubováky
RO Șurubelnițe de lăcătușerie
H Lakatos csavarhózó
E Juego de destornilladores

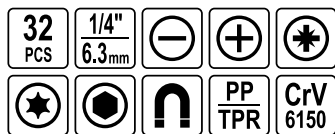

- ⊖ 4.0x75, 6.5x100, 8.0x150 mm; CrV 6150;
- ⊕ PH1x75, PH2x100 mm; CrV 6150;
- ⊗ PZ1x75, PZ2x100 mm; CrV 6150;
- ⊖ 2.0x50, 2.5x50, 3.0x50 mm; CrV 6150;
- ⊕ PH00x50, PH0x50, PH1x50 mm; CrV 6150;
- ⊗ 1/4" (6.3 mm);
- ⊖ 1/4" (6.3 mm); PH0, PH1, PH2 (L=25 mm); CrV 6150;
- ⊕ 1/4" (6.3 mm); PZ0, PZ1, PZ2 (L=25 mm); CrV 6150;
- ⊗ 1/4" (6.3 mm); T10, T15, T20, T25, T30 (L=25 mm); CrV 6150;
- ⊖ 1/4" (6.3 mm); 2, 2.5, 3, 4, 5, 6 mm (L=25 mm); CrV 6150



No.	pcs	☐
60785	32	10

PL Komplet wkrętek
GB Screwdriver set
D Schraubendrehersatz
RUS Набор отверток

CZ Zámečnické šroubováky
RO Șurubelnițe de lăcătușerie
H Lakatos csavarhózó
E Juego de destornilladores

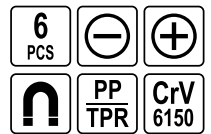

- ⊖ 5.5x75, 6.5x38, 6.5x100 mm; CrV 6150;
- ⊕ PH1x75; PH2x38, PH2x100 mm; CrV 6150



No.	pcs	☐
60783	6	10/20

PL Komplet wkrętek
GB Screwdriver set
D Schraubendrehersatz
RUS Набор отверток

CZ Zámečnické šroubováky
RO Șurubelnițe de lăcătușerie
H Lakatos csavarhózó
E Juego de destornilladores

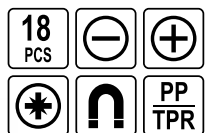

- ⊖ 2.5x50, 3.0x50 mm; CrV 6150;
- ⊕ 5.5x75, 6.5x38, 6.5x100, 8.0x150 mm; CrV 6150;
- ⊗ PH1x75, PH2x38, PH2x100, PH3x150 mm; CrV 6150;
- ⊕ PH00x50, PH0x50 mm; CrV 6150;
- ⊗ T5x50, T6x50, T7x50, T8x50, T9x50, T10x50 mm; CrV 6150



No.	pcs	☐
60781	18	10

PL Komplet wkrętek
GB Screwdriver set
D Schraubendrehersatz
RUS Набор отверток

CZ Zámečnické šroubováky
RO Șurubelnițe de lăcătușerie
H Lakatos csavarhózó
E Juego de destornilladores

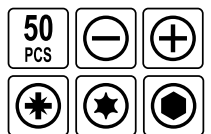

- ⊖ 4.0x75, 6.5x68, 6.5x100, 8.0x150 mm; CrV 6150;
- ⊕ PH1x75, PH2x38, PH2x100, PH3x150 mm; CrV 6150;
- ⊗ 2.0x50, 2.5x50, 3.0x50 mm; CrV 6150;
- ⊕ PH00x50, PH0x50 mm; CrV 6150;
- ⊗ T6x50, T8x50, T10x50 mm; CrV 6150;
- ⊖ 1/4" (6.3 mm); 3, 4, 5, 6 mm (L=25 mm); CrV 6150;
- ⊕ 1/4" (6.3 mm); PH0, PH1, PH2, PH3 (L=25 mm); CrV 6150;
- ⊗ 1/4" (6.3 mm); PZ0, PZ1, PZ2 (L=25 mm); CrV 6150;
- ⊕ 1/4" (6.3 mm); 2, 2.5, 3, 4, 5x2; 5.5, 6 mm (L=25 mm); CrV 6150;
- ⊗ 1/4" (6.3 mm); T8, T10, T15, T20, T25, T27, T30, T40 (L=25 mm); CrV 6150;
- ⊕ PH00x50, PH0x50 mm; CrV 6150;
- ⊗ 1/4" (6.3 mm); S0, S1, S2, S3 (L=25 mm); CrV 6150
- ⊖ 1/4" (6.3 mm);
- ⊗ 1/4" (6.3 mm);



No.	pcs	☐
60780	50	6

PL Wkrętek płaski
GB Slotted screwdriver
D Schraubendreher schlitz
RUS Отвёртка шлицевая

CZ Šroubovák
RO Şurubelniţă
H Csavarhúzó
E Destornillador

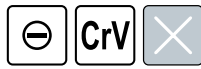

No.	mm		
61100	6.0x100		12/144
61110	6.0x100	HEX	12/144
61120	6.0x150		12/144
61130	6.0x150	HEX	12/144
61140	6.0x200		12/144
61150	6.0x250		12/144
61160	8.0x150		6/72
61170	8.0x150	HEX	6/72

PL Wkrętek krzyżakowy
GB Phillips screwdriver
D Kreuzschlitzschraubendreher
RUS Отвёртка крестовая

CZ Šroubovák křížový
RO Şurubelniţă în cruce
H Csavarhúzó kereszt
E Destornillador cruz



No.	mm		
61210	PH0x63		12/240
61220	PH0x75		12/240
61230	PH0x100		12/240
61240	PH0x150		12/240

PL Wkrętek krzyżakowy
GB Phillips screwdriver
D Kreuzschlitzschraubendreher
RUS Отвёртка крестовая

CZ Šroubovák křížový
RO Şurubelniţă în cruce
H Csavarhúzó kereszt
E Destornillador cruz



No.	mm		
61300	PH2x100		12/144
61310	PH2x100	HEX	12/144
61320	PH2x150		12/144
61330	PH2x150	HEX	12/144
61340	PH2x200		12/144
61350	PH2x250		12/144

PL Wkrętek krzyżakowy
GB Phillips screwdriver
D Kreuzschlitzschraubendreher
RUS Отвёртка крестовая

CZ Šroubovák křížový
RO Şurubelniţă în cruce
H Csavarhúzó kereszt
E Destornillador cruz



No.	mm		
61290	PH2x38		12/288

PL Wkrętek krzyżakowy
GB Phillips screwdriver
D Kreuzschlitzschraubendreher
RUS Отвёртка крестовая

CZ Šroubovák křížový
RO Şurubelniţă în cruce
H Csavarhúzó kereszt
E Destornillador cruz



No.	mm		
61250	PH1x75		12/240
61260	PH1x100		12/240
61270	PH1x150		12/240
61280	PH1x200		12/240

PL Wkrętek krzyżakowy
GB Phillips screwdriver
D Kreuzschlitzschraubendreher
RUS Отвёртка крестовая

CZ Šroubovák křížový
RO Şurubelniţă în cruce
H Csavarhúzó kereszt
E Destornillador cruz



No.	mm		
61360	03x150		6/72

PL Wkręтак
GB Screwdriver
D Schraubendreher
RUS Отвёртка

CZ Šroubovák
RO Şurubelniţă
H Csavarhúzó
E Destornillador



No.	mm	
61375	T5x75	12/240
61376	T6x75	12/240
61377	T7x75	12/240
61378	T8x75	12/240
61379	T9x75	12/240

PL Wkręтак
GB Screwdriver
D Schraubendreher
RUS Отвёртка

CZ Šroubovák
RO Şurubelniţa
H Csavarhúzó
E Destornillador



No.	mm	
61392	T10x200	12/240
61393	T15x200	12/240
61394	T20x200	12/240
61395	T25x200	12/144

PL Komplet wkręтакów
GB Screwdriver set
D Schraubendrehersatz
RUS Набор отвёрток

CZ Zámečnické šroubováky
RO Şurubelniţe de lăcătuşerie
H Lakatos csavarhúzó
E Juego de destornilladores

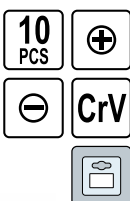

No.	pcs	
61600	10	6/12

PL Wkręтак
GB Screwdriver
D Schraubendreher
RUS Отвёртка

CZ Šroubovák
RO Şurubelniţa
H Csavarhúzó
E Destornillador



No.	mm	
61380	T10x100	12/240
61381	T15x100	12/240
61382	T20x100	12/240
61383	T25x100	12/144
61384	T27x100	12/144
61385	T30x100	12/144
61386	T40x100	12/144

PL Komplet wkręтакów
GB Screwdriver set
D Schraubendrehersatz
RUS Набор отвёрток

CZ Zámečnické šroubováky
RO Şurubelniţe de lăcătuşerie
H Lakatos csavarhúzó
E Juego de destornilladores



No.	pcs	packing:	
61550	5		5/20
61560	6		6/24

PL Wkręтак плоско-krzyżakowy
GB Slotted - phillips screwdriver
D Umsteckschraubendreher
RUS Отвёртка двухсторонняя

CZ Ploché a křížový šroubovák
RO Şurubelniţă dublu cap: plata + cruce
H Csavarhúzó, lapos-kereszt
E Destornillador plano-cruz

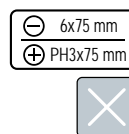

No.	type	
60910	R-1	30

PL Wkrętkak dwustronny
GB Two-way screwdriver
D Umsteckschraubendreher
RUS Отвёртка двухсторонняя

CZ Dvoustranný šroubovák
RO Şurubelniţă dublu capăt
H Kétoldalas csavarhúzó
E Destornillador de dos caras

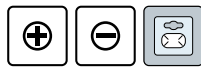

No. 64950  25/100

PL Komplet wkrętkaków
GB Screwdriver set
D Schraubendreherbitsatz
RUS Набор отвёрток

CZ Zámečnické šroubováky
RO Şurubelniţe de lăcătuşerie
H Lakatos csavarhúzó
E Juego de destornilladores

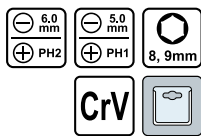

No. 64951  12/72

PL Zestaw końcówek śrubokrętowych
GB Precision screwdriver bits
D Schraubendreherbitsatz
RUS Набор специальных бит
CZ Sada bitov
RO Truse bit
H Bitkészlet
E Juego de llaves especiales

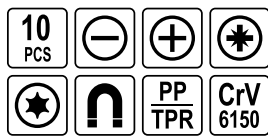

⊖ 5-6 mm (L=150 mm), CrV 6150;
⊕ PH1-PH2 (L=150 mm), CrV 6150;
⊕ PZ1-PZ2 (L=150 mm), CrV 6150;
⊕ T20-T25 (L=150 mm), CrV 6150;
⊕ HS-H6 (L=150 mm), CrV 6150



No. 64960  10 pcs 12/48

PL Zestaw wkrętek z grzechotką
GB Ratchet screwdriver set
D Ratschenschraubendreher-Satz mit Einsätzen
RUS Набор инструментов, отвёртка + головки + насадки
CZ Ráčňový kloubový šroubovák
RO Set surubelnita
H Dugókulcs és bit készlet csukló
E Juego con destornillador y carraca



No. 65170  41 pcs 15/30

PL Wkrętkak dwustronny
GB Two-way screwdriver
D Schraubendreher mit Doppelschlitz
RUS Отвёртка двухсторонняя со сменными вставками

CZ Dvoustranný šroubovák
RO Şurubelniţă dublu capăt
H Kétoldalas csavarhúzó
E Destornillador de dos caras

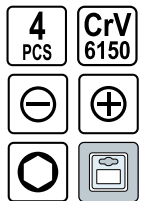

⊖ 5 mm x PH1
⊕ 6 mm x PH2
○ 6 x 8 mm



No. 64654  4 pcs 12/72

PL Wkrętkak dwustronny
GB Two-way screwdriver
D Umsteckschraubendreher
RUS Отвёртка двухсторонняя

CZ Dvoustranný šroubovák
RO Şurubelniţă dublu capăt
H Kétoldalas csavarhúzó
E Destornillador de dos caras

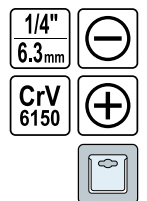

⊖ 6 mm x PH2; L=115 mm
↳ 1 pc screwdriver handle / 1szt. uchwył wkrętkaka



No. 64952  6/120

PL Wkrętkak
GB Screwdriver
D Schraubendreher
RUS Отвёртка магнитная с битами

CZ Šroubovák
RO Şurubelniţă
H Csavarhúzó
E Destornillador

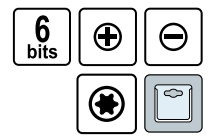

No. 65041  6 bits 25/100



- PL Zestaw końcówek śrubokrętowych
- GB Precision screwdriver bits
- D Schraubendreherbitsatz
- RUS Набор специальных бит
- CZ Sada bitov
- RO Truse bit
- H Bitkészlet
- E Juego de llaves especiales



- 1/4" (6.3 mm); (L=60 mm);
- 1/4" (6.3 mm); 4, 5, 6 mm (L=25 mm); CrV;
- 1/4" (6.3 mm); PH1, PH2, PH3 (L=25 mm); CrV;
- 1/4" (6.3 mm); PZ1, PZ2, PZ3 (L=25 mm); CrV;
- 1/4" (6.3 mm); T10, T15, T20 (L=25 mm); CrV



No.	pcs	☐
65035	13	6/24

- PL Zestaw wkrętek z grzechotką i bitami
- GB Ratchet screwdriver set with bits
- D Schraubendreher mit Ratche
- RUS Отвёртка реверсивная с набором бит
- CZ Šroubovák z řehťačkou
- RO Şurubelniţă cu clichet
- H Racsnis csavarbehajtó
- E Juego con destornillador y carraca

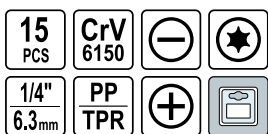

- 1/4" (6.3 mm); 6, 7, 8, 9, 10 mm;
- 1/4" (6.3 mm); CrV 6150;
- 1/4" (6.3 mm); (L=25 mm); CrV 6150;
- 1/4" (6.3 mm); 3, 4, 6 mm (L=25 mm); CrV 6150;
- 1/4" (6.3 mm); PH0, PH1, PH2 (L=25 mm); CrV 6150;
- 1/4" (6.3 mm); T15, T20 (L=25 mm); CrV 6150



No.	pcs	☐
65034	15	6/24

- PL Zestaw wkrętek z grzechotką i bitami
- GB Ratchet screwdriver set with bits
- D Schraubendreher mit Ratche
- RUS Отвёртка реверсивная с набором бит
- CZ Šroubovák z řehťačkou
- RO Şurubelniţă cu clichet
- H Racsnis csavarbehajtó
- E Juego con destornillador y carraca

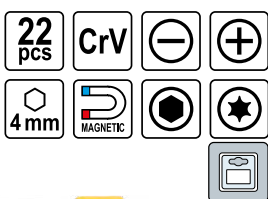

- 1.5, 2.0, 2.5, 3.0 mm; CrV;
- PH000, PH000, PH0, PH1; CrV;
- 1.5, 2.0, 2.5, 3.0, 4.0 mm; CrV;
- T6, T7, T8, T9, T10, T15, T20; CrV;
- 115 mm; CrV



No.	pcs	☐
64402	22	6/36

- PL Zestaw wkrętek z grzechotką i bitami
- GB Ratchet screwdriver set with bits
- D Schraubendreher mit Ratche
- RUS Отвёртка реверсивная с набором бит
- CZ Šroubovák z řehťačkou
- RO Şurubelniţă cu clichet
- H Racsnis csavarbehajtó
- E Juego con destornillador y carraca

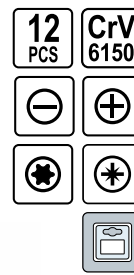

- 1/4" (6.3 mm); 3.5, 4, 5.5 mm (L=25 mm)
- 1/4" (6.3 mm); PH0, PH1, PH2 (L=25 mm)
- 1/4" (6.3 mm); T20, T25 (L=25 mm)
- 1/4" (6.3 mm); PZ0, PZ1, PZ2 (L=25 mm)



No.	pcs	☐
64658	12	12/72

- PL Zestaw końcówek śrubokrętowych
- GB Precision screwdriver bits
- D Schraubendreherbitsatz
- RUS Набор специальных бит
- CZ Sada bitov
- RO Truse bit
- H Bitkészlet
- E Juego de llaves especiales

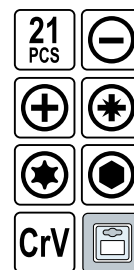

- 1/4" (6.3 mm); (L=60 mm);
- 1/4" (6.3 mm); 4, 5, 6, 7 mm (L=25 mm); CrV;
- 1/4" (6.3 mm); PH1, PH2, PH3 (L=25 mm); CrV;
- 1/4" (6.3 mm); PZ1, PZ2, PZ3 (L=25 mm); CrV;
- 1/4" (6.3 mm); T10, T15, T20, T25, T27, T30 (L=25 mm); CrV
- 1/4" (6.3 mm); 3, 4, 5, 6 mm (L=25 mm); CrV;



No.	pcs	☐
65015	21	9/36

- PL Zestaw wkrętek z grzechotką i bitami
- GB Ratchet screwdriver set with bits
- D Schraubendreher mit Ratche
- RUS Отвёртка реверсивная с набором бит
- CZ Šroubovák z řehťačkou
- RO Şurubelniţă cu clichet
- H Racsnis csavarbehajtó
- E Juego con destornillador y carraca

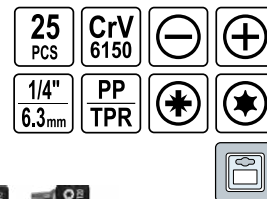

- 1/4" (6.3 mm); 4, 5, 6, 7, 8, 9, 10, 11, 12 mm;
- 1/4" (6.3 mm); (L=160 mm); CrV 6150;
- 1/4" (6.3 mm); PH0, PH1, PH2, PH3 (L=25 mm); CrV 6150;
- 1/4" (6.3 mm); PZ0, PZ1, PZ2, PZ3 (L=25 mm); CrV 6150;
- 1/4" (6.3 mm); T10, T15, T20 (L=25 mm); CrV 6150



No.	pcs	☐
65105	25	6/36

PL Zestaw wkrętak z grzechotką i bitami
 GB Ratchet screwdriver set with bits
 D Schraubendreher mit Ratche
 RUS Отвёртка реверсивная с набором бит
 CZ Šroubovák z fehtačkou
 RO Şurubelniţă cu clichet
 H Racsnis csavarbehajtó
 E Juego con destornillador y carraca

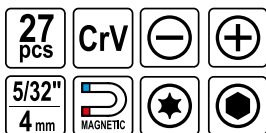

- 1 2.0, 3.0, 4.0 mm (L=50 mm); CrV;
- 2 2.5, 3.0, 3.5, 4.0, 4.5, 5.0 mm (L=55 mm); CrV;
- 3 PH00, PH0, PH1, PH2 (L=50 mm); CrV;
- 4 4.0, 4.5, 5.0, 5.5, 6.0 mm;
- 5 T5, T6, T7, T8, T9, T10, T15 (L=50 mm); CrV;
- 6 4x75 mm; CrV;
- 7 1 pc 65 mm mini screwdriver / 1 szt. mini wkrętak 95 mm



No.	pcs	box
64386	27	6/48

PL Zestaw wkrętak z grzechotką i bitami
 GB Ratchet screwdriver set with bits
 D Schraubendreher mit Ratche
 RUS Отвёртка реверсивная с набором бит
 CZ Šroubovák z fehtačkou
 RO Şurubelniţă cu clichet
 H Racsnis csavarbehajtó
 E Juego con destornillador y carraca

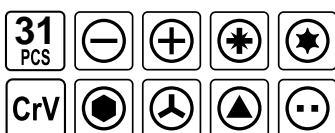

1 pc ratchet screwdriver handle / 1 szt. wkrętak z grzechotką
 1 pc tweezer with 3x magnifying glass / 1 szt. pęseta z lupą 3x
 1 pc storage box / 1 szt. pudełko na bity

- 1 1.0, 1.5, 2.0, 2.5, 3.0 mm; CrV;
- 2 2.0, 3.0 mm; CrV;
- 3 PH000, PH00, PH0, PH1, PH2; CrV;
- 4 P20, P21; CrV;
- 5 T4, T5, T6, T7, T8, T10; CrV;
- 6 115 mm; CrV;
- 7 0.7, 0.9, 1.3, 1.5, 2.0, 3.0 mm; CrV;
- 8 3.0 mm; CrV;
- 9 3.0 mm; CrV;
- 10 2.6 mm; CrV;



No.	pcs	box
65025	31	6/24

PL Zestaw wkrętak z grzechotką i bitami
 GB Ratchet screwdriver set with bits
 D Schraubendreher mit Ratche
 RUS Отвёртка реверсивная с набором бит
 CZ Šroubovák z fehtačkou
 RO Şurubelniţă cu clichet
 H Racsnis csavarbehajtó
 E Juego con destornillador y carraca

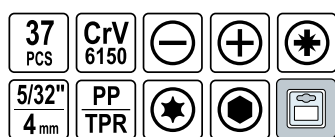

- 1 5/32" (4 mm); CrV 6150;
- 2 5/32" (4 mm); (L=100 mm); CrV 6150;
- 3 5/32" (4 mm); 1.0, 1.5, 2.0, 2.5, 3.0, 3.5 mm (L=28 mm); CrV 6150;
- 4 5/32" (4 mm); PH000, PH00, PH0, PH1 (L=28 mm); CrV 6150;
- 5 5/32" (4 mm); P20, P21 (L=28 mm); CrV 6150;
- 6 5/32" (4 mm); T4, T5, T6, T7, T8, T9, T10, T15, T20 (L=28 mm); CrV 6150;
- 7 5/32" (4 mm); 0.7, 0.9, 1.3, 2.0, 2.5, 3.0, 4.0 mm (L=28 mm); CrV 6150;
- 8 5/32" (4 mm); 2.5, 3.0, 3.5, 4.0, 4.5, 5.0, 5.5 mm

No.	pcs	box
65022	37	6/24

PL Wkrętak z grzechotką i wymiennymi końcówkami
 GB Ratchet screwdriver set with bits
 D Schraubendreher mit Ratche
 RUS Отвёртки с набором бит
 CZ Šroubovák z fehtačkou
 RO Şurubelniţă cu clichet
 H Racsnis csavarbehajtó
 E Juego con destornillador y carraca



- 1 1/4" (6.3 mm); 3, 3.5, 4, 5, 5.5, 6 mm (L=25 mm)
- 2 1/4" (6.3 mm); PH0, PH1, PH2, PH3 (L=25 mm)
- 3 1/4" (6.3 mm); T10, T15, T20, T25, T27, T30 (L=25 mm)
- 4 1/4" (6.3 mm); P20, P21, P22, P23 (L=25 mm)
- 5 1/4" (6.3 mm); 2, 2.5, 3, 4, 5, 6 mm (L=25 mm)
- 6 1/4" (6.3 mm); S0, S1 (L=25 mm)
- 7 2.0 x 50 mm
- 8 PH00 x 50 mm



No.	pcs	box
64655	31	6/36

PL Wkrętak z grzechotką i wymiennymi końcówkami
 GB Ratchet screwdriver set with bits
 D Schraubendreher mit Ratche
 RUS Отвёртка реверсивная с набором бит
 CZ Šroubovák z fehtačkou
 RO Şurubelniţă cu clichet
 H Racsnis csavarbehajtó
 E Juego con destornillador y carraca

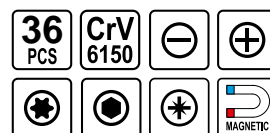

- 1 1/4" (6.3 mm); 3, 3.5, 4, 5.5 mm (L=25 mm)
- 2 1/4" (6.3 mm); PH0, PH1, PH2, PH3 (L=25 mm)
- 3 1/4" (6.3 mm); T10, T15, T20, T25, T27, T30 (L=25 mm)
- 4 1/4" (6.3 mm); P20, P21, P22, P23 (L=25 mm)
- 5 1/4" (6.3 mm); 3, 4 mm (L=25 mm)
- 6 1/4" (6.3 mm); 4, 4.5, 5, 6, 7, 8, 9, 10, 11, 12, 13 mm
- 7 50 mm



No.	pcs	box
64660	36	6/24

PL Zestaw wkrętak z grzechotką i bitami
 GB Ratchet screwdriver set with bits
 D Schraubendreher mit Ratche
 RUS Отвёртка реверсивная с набором бит
 CZ Šroubovák z fehtačkou
 RO Şurubelniţă cu clichet
 H Racsnis csavarbehajtó
 E Juego con destornillador y carraca

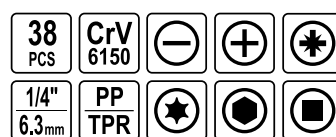

- 1 1/4" (6.3 mm); 4, 5, 6, 7, 8, 9, 10, 11, 12 mm;
- 2 1/4" (6.3 mm); PH0, PH1, PH2, PH3 (L=25 mm); CrV 6150;
- 3 1/4" (6.3 mm); P20, P21, P22, P23 (L=25 mm); CrV 6150;
- 4 1/4" (6.3 mm); T10, T15, T20, T25, T27, T30 (L=25 mm); CrV 6150;
- 5 1/4" (6.3 mm); 2, 3, 4, 5, 6 mm (L=25 mm); CrV 6150;
- 6 1/4" (6.3 mm); 3, 4, 5, 6 mm (L=25 mm); CrV 6150;
- 7 1/4" (6.3 mm); S0, S1, S2, S3 (L=25 mm); CrV 6150

No.	pcs	box
65023	38	6/24

3

PL Zestaw wkrętek z grzechotką i bitami
 GB Ratchet screwdriver set with bits
 D Schraubendreher mit Ratche
 RUS Отвёртка реверсивная с набором бит
 CZ Šroubovák z řehačkou
 RO Şurubelniţă cu clichet
 H Racsnis csavarbehajtó
 E Juego con destornillador y carraca



- 1/4" (6.3 mm): 5, 6, 7, 8, 9, 10 mm (L=20 mm); CrV;
- 3.0, 4.0, 5.0, 6.0 mm; CrV;
- PH0, PH1, PH2, PH3; CrV;
- P20, P21, P22, P23; CrV;
- T15, T20, T25, T30; CrV;
- 3.0, 4.0, 5.0, 6.0 mm; CrV;
- 1/8" (3.2 mm), 5/32" (4.0 mm), 3/16" (4.8 mm), 1/4" (6.3 mm); CrV;
- S0, S1, S2, S3 mm; CrV;
- 1/4" (6.3 mm); (L=25 mm); CrV;
- 1/4" (6.3 mm) (L=60 mm); CrV;
- 1 pc 115 mm mini ratchet screwdriver / 1szt. mini wkrętkaz z grzechotką 115 mm



No.	pcs	
64385	41	6/24

PL Zestaw wkrętek z grzechotką i bitami
 GB Ratchet screwdriver set with bits
 D Schraubendreher mit Ratche
 RUS Отвёртка реверсивная с набором бит
 CZ Šroubovák z řehačkou
 RO Şurubelniţă cu clichet
 H Racsnis csavarbehajtó
 E Juego con destornillador y carraca

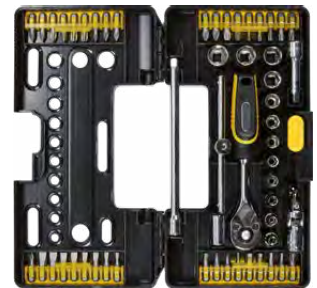
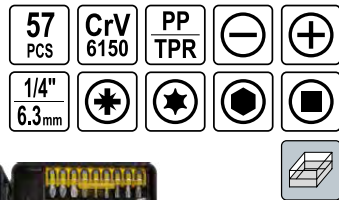

- 1/4" (6.3 mm): 4, 4.5, 5, 5.5, 6, 7, 8, 9, 10, 11, 12, 13 mm (L=25 mm); CrV 6150;
- 1/4" (6.3 mm): (50, 150 mm); CrV 6150;
- 1/4" (6.3 mm); CrV 6150;
- 1/4" (6.3 mm); (115 mm); CrV 6150;
- 1/4" (6.3 mm); (155 mm); 1/4" (6.3 mm) x 1/4" (6.3 mm); CrV 6150;
- 1/4" (6.3 mm): 3, 4, 5 x2, 6 x2, 7 x2 mm (L=25 mm); CrV 6150;
- 1/4" (6.3 mm): PH0, PH1 x2, PH2 x2, PH3 x2 (L=25 mm); CrV 6150;
- 1/4" (6.3 mm): P20, P21 x2, P22 x2, P23 x2 (L=25 mm); CrV 6150;
- 1/4" (6.3 mm): T10, T15, T20, T25, T27, T30 (L=25 mm); CrV 6150;
- 1/4" (6.3 mm): 3, 4, 5, 6 mm (L=25 mm); CrV 6150;
- 1/4" (6.3 mm): S0, S1, S2, S3 (L=25 mm); CrV 6150;
- 1.5, 2, 2.5 mm; CrV 6150

No.	pcs	
65020	57	6/12

PL Zestaw wkrętek z grzechotką i bitami
 GB Ratchet screwdriver set with bits
 D Schraubendreher mit Ratche
 RUS Отвёртка реверсивная с набором бит
 CZ Šroubovák z řehačkou
 RO Şurubelniţă cu clichet
 H Racsnis csavarbehajtó
 E Juego con destornillador y carraca

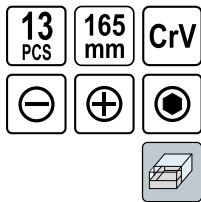

No.	bits	
65123	12	20

- 5/16" (7.9mm) □ □ □ 1/2" (12.7mm);
- □ □ 5, 6, 8, 9 mm (L=35 mm);
- □ □ PH1, PH2, PH3, PH4 (L=35 mm);
- □ □ 4, 5, 6, 8 mm (L=35 mm)

PL Zestaw wkrętek z grzechotką i bitami
 GB Ratchet screwdriver set with bits
 D Schraubendreher mit Ratche
 RUS Отвёртка реверсивная с набором бит
 CZ Šroubovák z řehačkou
 RO Şurubelniţă cu clichet
 H Racsnis csavarbehajtó
 E Juego con destornillador y carraca

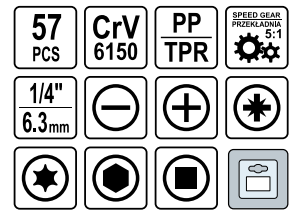

- 1/4" (6.3 mm); CrV 6150;
- 1/4" (6.3 mm): 3 x2, 4 x2, 5 x3, 6 x5, 7 x2 mm (L=25 mm); CrV 6150;
- 1/4" (6.3 mm): PH0 x2, PH1 x2, PH2 x7, PH3 x3 (L=25 mm); CrV 6150;
- 1/4" (6.3 mm): P20, P21 x2, P22 x2, P23 x2 (L=25 mm); CrV 6150;
- 1/4" (6.3 mm): T10, T15, T20, T25 x2, T27, T30 (L=25 mm); CrV 6150;
- 1/4" (6.3 mm): 3, 4 x2, 5 x2, 6 x2 mm (L=25 mm); CrV 6150;
- 1/4" (6.3 mm): S0, S1 x2, S2 x2, S3 x2 (L=25 mm); CrV 6150



No.	pcs	
65033	57	6/12

PL Wkrętkaz udarowy
 GB Impact screwdriver
 D Schlagschrauber
 RUS Отвёртка цельнометаллическая ударная

CZ Narazový šroubovák kovový
 RO Şurubelniţă metalică cu percutor
 H Csavarbehajtó, ütő üzemmóddal
 E Destornillador de percusión



No.	bits	
65120	4	25

PL Wkrętkaz udarowy
 GB Impact screwdriver
 D Schlagschrauber
 RUS Отвёртка слесарная с ударом
 CZ Narazový šroubovák kovový
 RO Şurubelniţă metalică cu percutor
 H Csavarbehajtó, ütő üzemmóddal
 E Destornillador de percusión

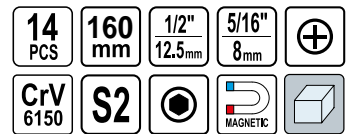

No.	pcs	
65124	14	20

- 5/16" (7.9mm) □ □ □ 1/2" (12.7mm);
- □ □ 4, 5, 6, 8, 9 mm (L=35 mm); S2;
- □ □ PH1, PH2, PH3 (L=35 mm); S2;
- □ □ 4, 5, 6, 8 mm (L=35 mm); S2

PL Wkrętak magnetyczny, teleskopowy
 GB Telescopic screwdriver, magnetic
 D Schraubendreher
 RUS Отвёртка магнитная с битами

CZ Magnetický řoubavak -teleskop
 RO Surubelnița telescopică cu magnet
 H Mágneses csavarbehajtó-teleszkop
 E Destornillador magnético-telescop.



No.	bits	
65045	6	25/100

PL Wkrętak z teleskopowym chwytakiem magnetycznym
 GB Screwdriver with magnetic telescopic pick-up tool
 D Schraubendreher mit auschiebbarem magnetischem Halter
 RUS Отвёртка магнитная с битами
 CZ Magnetický řoubavak-teleskop
 RO Șurubelniță cu magnet-telescop
 H Mágneses csavarbehajtó-teleszkop
 E Destornillador magnético-telescop



RATCHET
 SCREWDRIVER
 FORWARD
 AND REWARD
 ROTATION,
 LOCKING

WKREŃTAK
 Z GRZECHOTKĄ
 LEWY I PRAWY
 OBRÓTY,
 BLOKADA

- 4, 5, 6, 7 mm (L= 25 mm); CrV
- ⊕ PH1, PH2, PH3 (L= 25 mm); CrV
- ⊕ T10, T15, T20, T25, T30 (L= 25 mm); CrV
- 1 pc telescopic ratchet screwdriver 50-120 mm
 1szt. teleskopowy wkrętak z grzechotką 50-120 mm



No.		
65046	5/50	

PL Wkrętak T-gryf
 GB T-bar screwdriver set
 D T-griff Schraubendrehersatz
 RUS Отвёртка с T-образной
 ручкой и насадками
 CZ Šroubovák T-gryf
 RO Set șurubelnița tip „T”
 H Csavarbehajtó, T-gryf
 E Destornillador T-grifo

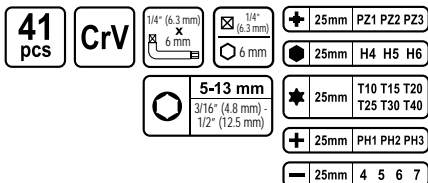

No.	pcs	
65150	41	24

PL Komplet wkrętaków
 GB Screwdriver set
 D Schraubendrehersatz
 RUS Набор отвёрток слесарных

CZ Zámečnické šroubováky
 RO Șurubelnițe de lăcătușerie
 H Lakatos csavarhőző
 E Juego de destornilladores



No.	pcs	
64050	6	20/80

PL Wkrętak z teleskopowym chwytakiem magnetycznym
 GB Screwdriver with magnetic telescopic pick-up tool
 D Schraubendreher mit auschiebbarem magnetischem Halter
 RUS Отвёртка магнитная с битами
 CZ Magnetický řoubavak-teleskop
 RO Șurubelniță cu magnet-teleskop
 H Mágneses csavarbehajtó-teleszkop
 E Destornillador magnético-telescop



- 1/4" (6.3 mm); 3, 4, 5.5 mm (L=25 mm)
- ⊕ 1/4" (6.3 mm); PH1, PH2 (L=25 mm)
- ⊕ 1/4" (6.3 mm); PZ1, PZ2 (L=25 mm)

No.	pcs	
64650	8	12/72

PL Wkrętak T-gryf
 GB T-bar screwdriver
 D T-griff Schraubendrehersatz
 RUS Отвёртка с T-образной
 ручкой и насадками

CZ Šroubovák T-gryf
 RO Set șurubelnița tip „T”
 H Csavarbehajtó, T-gryf
 E Destornillador T-grifo



No.	bits	
65100	20	10/80

PL Komplet wkrętaków
 GB Screwdriver set
 D Schraubendrehersatz
 RUS Набор отвёрток слесарных

CZ Zámečnické šroubováky
 RO Șurubelnițe de lăcătușerie
 H Lakatos csavarhőző
 E Juego de destornilladores

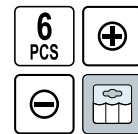

No.	pcs	
64060	6	20/60

PL Komplet wkrętaków
 GB Screwdriver set
 D Schraubendrehersatz
 RUS Набор отвёрток

CZ Zámečnické šroubováky
 RO Șurubelnițe de lăcătușerie
 H Lakatos csavarhőző
 E Juego de destornilladores

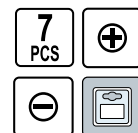

No.	pcs	
64070	7	20/80

PL Komplet wkrętek
GB Screwdriver set
D Schraubendrehersatz
RUS Набор отвёрток

CZ Zámečnické šroubováky
RO Şurubelnițe de lăcătuşerie
H Lakatos csavarhúzó
E Juego de destornilladores



No.	pcs	box
64090	6	10/60

PL Zestaw końcówek śrubokrętowych + uchwyt
GB Precision screwdriver bits + bit holder
D Schraubendreherbitsatz + Bithalter
RUS Отвёртка с набором специальных бит
CZ Sada bitův + držák
RO Truse bit + capete şurubel niță
H Bitkészlet + szár
E Juego de llaves especiales + mandril

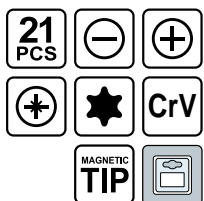

No.	pcs	box
64370	21	10/60

PL Zestaw wkrętek z grzechotką i bitami
GB Ratchet screwdriver set with bits
D Schraubendreher mit Ratche
RUS Отвёртка реверсивная с набором бит
CZ Šroubovák z řehačkou
RO Şurubelniță cu clichet
H Racsnis csavarbehajtó
E Juego con destornillador y carraca

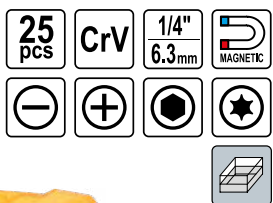

1.0, 1.5, 2.0, 2.5, 3.0, 3.5, 4.0 mm
PH000, PH00, PH0, PH1
P20, P21
T4, T5, T6, T7, T8, T9, T10, T15, T20
2.5, 3.0 mm; 1/8" (3.2 mm), 9/64" (3.8 mm) (L= 115 mm)
4.0, 5.0, 6.0 mm; 5/32" (4.0 mm), 3/16" (4.8 mm), 1/4" (6.3 mm)
(L= 163 mm), CrV

No.	pcs	box
65880	25	6/24

PL Zestaw wkrętek z grzechotką i bitami
GB Ratchet screwdriver set with bits
D Schraubendreher mit Ratche
RUS Отвёртка реверсивная с набором бит
CZ Šroubovák z řehačkou
RO Şurubelniță cu clichet
H Racsnis csavarbehajtó
E Juego con destornillador y carraca

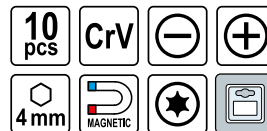

1.0, 1.5, 2.0 mm; CrV;
PH00, PH0, PH1; CrV;
T6, T7, T8; CrV



No.	pcs	box
64400	10	8/144

PL Zestaw wkrętek z grzechotką i bitami
GB Ratchet screwdriver set with bits
D Schraubendreher mit Ratche
RUS Отвёртка реверсивная с набором бит
CZ Šroubovák z řehačkou
RO Şurubelniță cu clichet
H Racsnis csavarbehajtó
E Juego con destornillador y carraca

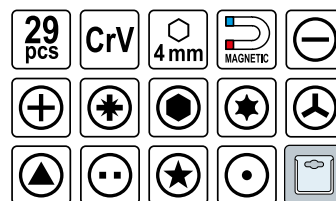

0.7, 1.0, 1.2, 1.5, 1.8 mm; CrV;
PH000, PH00, PH0, PH1; CrV;
P2000, P200, P20, P21; CrV;
0.7, 0.9, 1.3, 1.5, 2.0 mm; CrV;
T4, T5, T6, T7, T8; CrV;
3.0 mm; CrV;
3.0 mm; CrV;
2.6 mm; CrV;
2.0 mm; CrV;
1.0 mm; CrV



No.	pcs	box
64401	29	12/48

PL Zestaw końcówek śrubokrętowych + uchwyt
GB Precision screwdriver bits + bit holder
D Schraubendreherbitsatz + Bithalter
RUS Отвёртка с набором специальных бит
CZ Sada bitův + držák
RO Truse bit + capete şurubel niță
H Bitkészlet + szár
E Juego de llaves especiales + mandril

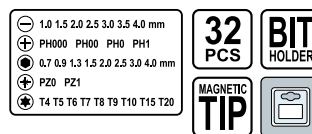

No.	pcs	box
64371	32	10/20

PL Zestaw wkrętek precyzyjnych
 GB Precision screwdriver set
 D Präzisions-Feinmechanikersatz
 RUS Набор отвёрток для точных работ

CZ Šroubová sada
 RO Set surubelnite
 H Órás csavarhúzó készlet
 E Destornilladores precisos

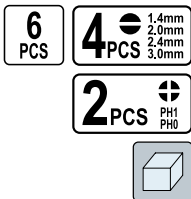

No.	pcs	Box
64310	6	20/100

PL Zestaw wkrętek precyzyjnych i haczyków
 GB Precision screwdriver set
 D Präzisions-Feinmechanikersatz
 RUS Набор отвёрток для точных работ

CZ Šroubová sada
 RO Set surubelnite
 H Órás csavarhúzó készlet
 E Destornilladores precisos



⊖ 2.5 mm, 3.5 mm
 ⊕ PH00, PH0
 ⬠ T6, T7, T8, T10 45°; 90°, 135°, 180°



No.	pcs	Box
64555	12	10/40

PL Zestaw końcówek śrubokrętowych + uchwyt
 GB Precision screwdriver bits + bit holder
 D Schraubendreherbitsatz + Bithalter
 RUS Отвёртка с набором специальных бит

CZ Sada bitov + držák
 RO Truse bit + capete şurubel niţă
 H Bitkészlet + szár
 E Juego de llaves especiales + mandril

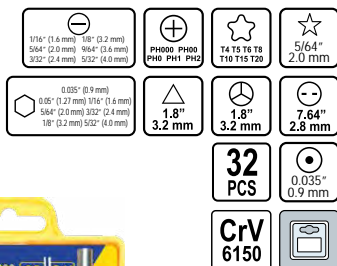

No.	pcs	Box
64396	32	10/50

PL Zestaw wkrętek precyzyjnych
 GB Precision screwdriver set
 D Präzisions-Feinmechanikersatz
 RUS Набор отвёрток для точных работ

CZ Šroubová sada
 RO Set surubelnite
 H Órás csavarhúzó készlet
 E Destornilladores precisos



No.	pcs	Box
64330	11	25/100

PL Zestaw końcówek śrubokrętowych + uchwyt
 GB Precision screwdriver bits + bit holder
 D Schraubendreherbitsatz + Bithalter
 RUS Отвёртка с набором специальных бит

CZ Sada bitov + držák
 RO Truse bit + capete şurubel niţă
 H Bitkészlet + szár
 E Juego de llaves especiales + mandril

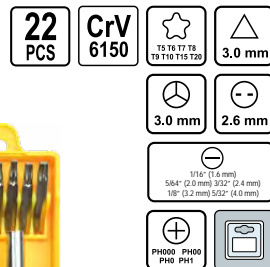

No.	pcs	Box
64395	22	10/50

PL Zestaw do naprawy telefonów komórkowych
 GB Mobile phone repair tools set
 D Mobiltelefon Reparatur Satz
 RUS Набор инструмента для ремонта мобильных телефонов

CZ Nástroje na opravu / otevření mobilních telefonů, sada nástrojů
 RO Set surubelnite service telefoane mobile
 H Mobiltelefon-javítás szerszámkészlet
 E Herramientas de la reparación del teléfono móvil fijadas



⊖ 1.0, 2.0 mm; CrV; ⬠ 0.8 x2, 1.2, 1.5 mm; CrV;
 ⊕ PH000, PH00, PH0, PH1; CrV; ⬠ Y000, Y00, Y0; CrV;
 ⬠ T2, T3, T4, T5, T6, T8, T10; CrV; ⬠ 3.0 mm; CrV;
 ⬠ T7; CrV;
 ⊖ 1.5, 2.0 mm; CrV; ⊖ 4x75 mm; CrV

No.	pcs	Box
64384	32	6/48

PL Wkrętaki precyzyjne
 GB Precision screwdriver set
 D Präzisions-Schraubendrehersatz
 RUS Набор отверток для точных работ

CZ Precizní šroubováky
 RO Șurubelnițe precise
 H Precíziós csavarhúzó
 E Destornilladores precisos

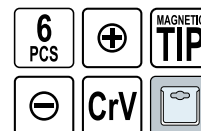

3 VOREL

No.		pcs	
64553	PH00; PH0; PH1; 1.4; 2.4; 3.0	6	10/60
64554	T5; T6; T7; T8; T9; T10	6	10/60

PL Zestaw końcówek śrubokrętowych
 GB Screwdriver bit set
 D Schraubendreherbitsatz
 RUS Набор бит крестовых
 CZ Sada bitů
 RO Truse bit
 H Bitkészlet
 E Puntas de destornilladora

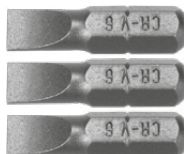
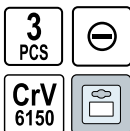

STHOR

No.		L (mm)		torque / moment obrotowy max. (Nm)	pcs	
65480	4	25	1/4" (6.3 mm)	1.4	3	144/288
65481	5	25	1/4" (6.3 mm)	3.2	3	144/288
65482	6	25	1/4" (6.3 mm)	5.8	3	144/288
65483	8	25	1/4" (6.3 mm)	11.5	3	144/288

PL Zestaw końcówek śrubokrętowych
 GB Screwdriver bit set
 D Schraubendreherbitsatz
 RUS Набор бит крестовых
 CZ Sada bitů
 RO Truse bit
 H Bitkészlet
 E Puntas de destornilladora

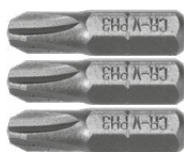
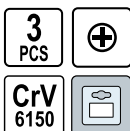

STHOR

No.		L (mm)		torque / moment obrotowy max. (Nm)	pcs	
65461	PH1; PH2; PH3	25	1/4" (6.3 mm)	3.5; 8.2; 19.5	3	144/288

PL Zestaw końcówek śrubokrętowych
 GB Screwdriver bit set
 D Schraubendreherbitsatz
 RUS Набор бит крестовых
 CZ Sada bitů
 RO Truse bit
 H Bitkészlet
 E Puntas de destornilladora

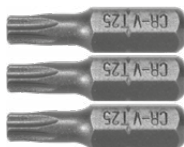
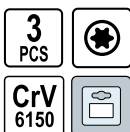

STHOR

No.		L (mm)		torque / moment obrotowy max. (Nm)	pcs	
65490	T8	25	1/4" (6.3 mm)	2.2	3	144/288
65491	T9	25	1/4" (6.3 mm)	2.8	3	144/288
65492	T10	25	1/4" (6.3 mm)	3.7	3	144/288
65493	T15	25	1/4" (6.3 mm)	6.4	3	144/288
65494	T20	25	1/4" (6.3 mm)	10.5	3	144/288
65495	T25	25	1/4" (6.3 mm)	15.9	3	144/288
65496	T27	25	1/4" (6.3 mm)	22.5	3	144/288
65497	T30	25	1/4" (6.3 mm)	31.1	3	144/288
65498	T40	25	1/4" (6.3 mm)	54.1	3	144/288

PL Zestaw końcówek śrubokrętowych
 GB Screwdriver bit set
 D Schraubendreherbitsatz
 RUS Набор бит крестовых
 CZ Sada bitů
 RO Truse bit
 H Bitkészlet
 E Puntas de destornilladora

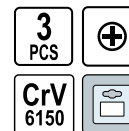

STHOR

No.		L (mm)		torque / moment obrotowy max. (Nm)	pcs	
65451	PH0	25	1/4" (6.3 mm)	1.0	3	144/288
65452	PH1	25	1/4" (6.3 mm)	3.5	3	144/288
65453	PH2	25	1/4" (6.3 mm)	8.2	3	144/288
65454	PH3	25	1/4" (6.3 mm)	19.5	3	144/288

PL Zestaw końcówek śrubokrętowych
 GB Screwdriver bit set
 D Schraubendreherbitsatz
 RUS Набор бит крестовых
 CZ Sada bitů
 RO Truse bit
 H Bitkészlet
 E Puntas de destornilladora

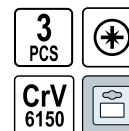

STHOR

No.		L (mm)		torque / moment obrotowy max. (Nm)	pcs	
65470	PZ1	25	1/4" (6.3 mm)	3.5	3	144/288
65471	PZ2	25	1/4" (6.3 mm)	8.2	3	144/288
65472	PZ3	25	1/4" (6.3 mm)	19.5	3	144/288

PL Zestaw końcówek śrubokrętowych
 GB Screwdriver bit set
 D Schraubendreherbitsatz
 RUS Набор бит крестовых
 CZ Sada bitů
 RO Truse bit
 H Bitkészlet
 E Puntas de destornilladora

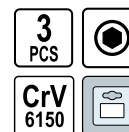

STHOR

No.		L (mm)		torque / moment obrotowy max. (Nm)	pcs	
65501	3	25	1/4" (6.3 mm)	6.6	3	144/288
65502	4	25	1/4" (6.3 mm)	16.0	3	144/288
65503	5	25	1/4" (6.3 mm)	30.0	3	144/288
65504	6	25	1/4" (6.3 mm)	52.0	3	144/288
65505	8	25	1/4" (6.3 mm)	55.0	3	144/288

PL Zestaw końcówek śrubokrętowych
 GB Screwdriver bit set
 D Schraubendreherbitsatz
 RUS Набор бит крестовых
 CZ Sada bitů
 RO Truse bit
 H Bitkészlet
 E Puntas de destornilladora

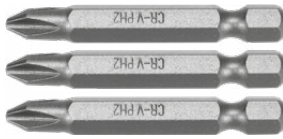
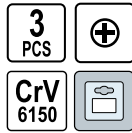

No.	⊕	L (mm)	⬡	torque / moment obrotowy max. (Nm)	pcs	📦
65456	PH1	50	1/4" (6.3 mm)	3.5	3	144/288
65457	PH2	50	1/4" (6.3 mm)	8.2	3	144/288
65458	PH3	50	1/4" (6.3 mm)	19.5	3	144/288

PL Zestaw końcówek śrubokrętowych
 GB Screwdriver bit set
 D Schraubendreherbitsatz
 RUS Набор бит крестовых
 CZ Sada bitů
 RO Truse bit
 H Bitkészlet
 E Puntas de destornilladora

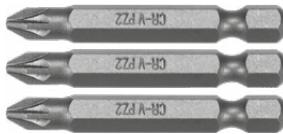
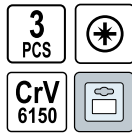

No.	⊕	L (mm)	⬡	torque / moment obrotowy max. (Nm)	pcs	📦
65475	PZ1	50	1/4" (6.3 mm)	3.5	3	144/288
65476	PZ2	50	1/4" (6.3 mm)	8.2	3	144/288
65477	PZ3	50	1/4" (6.3 mm)	19.5	3	144/288

PL Zestaw końcówek śrubokrętowych
 GB Screwdriver bit set
 D Schraubendreherbitsatz
 RUS Набор бит крестовых

CZ Sada bitů
 RO Truse bit
 H Bitkészlet
 E Puntas de destornilladora



No.	⊕	L (mm)	pcs	📦
65520	PZ2	25	10	25/200

PL Zestaw końcówek śrubokrętowych
 GB Screwdriver bit set
 D Schraubendreherbitsatz
 RUS Набор бит крестовых
 CZ Sada bitů
 RO Truse bit
 H Bitkészlet
 E Puntas de destornilladora



No.	⊕	L (mm)	⬡	torque / moment obrotowy max. (Nm)	pcs	📦
65462	PH1; PH2; PH3	50	1/4" (6.3 mm)	3.5; 8.2; 19.5	3	144/288

PL Zestaw końcówek śrubokrętowych
 GB Screwdriver bit set
 D Schraubendreherbitsatz
 RUS Биты двухсторонние
 CZ Sada bitů
 RO Truse bit
 H Bitkészlet
 E Puntas de destornilladora

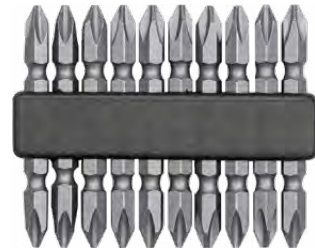

No.	⊕	L (mm)	pcs	📦
65700	PH2	60	10	25/100

PL Zestaw końcówek śrubokrętowych
 GB Screwdriver bit set
 D Schraubendreherbitsatz
 RUS Набор бит крестовых

CZ Sada bitů
 RO Truse bit
 H Bitkészlet
 E Puntas de destornilladora



No.	⊕	L (mm)	pcs	📦
65610	PH1	25	10	25/200
65620	PH1	50	10	25/100
65630	PH2	25	10	25/200
65640	PH2	50	10	25/100
65650	PH2	75	10	25/100

PL Zestaw końcówek śrubokrętowych
 GB Screwdriver bit set
 D Schraubendreherbitsatz
 RUS Набор битов
 CZ Sada bitů
 RO Truse bit
 H Bitkészlet
 E Puntas de destornilladora

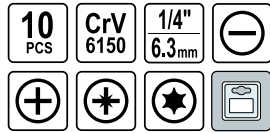

- 1/4" (6.3 mm): 5, 6 mm (L=25 mm); CrV;
- 1/4" (6.3 mm): PH0, PH1, PH2 (L=25 mm); CrV;
- 1/4" (6.3 mm): PZ1, PZ2 (L=25 mm); CrV;
- 1/4" (6.3 mm): T15, T20 (L=25 mm); CrV;
- 1/4" (6.3 mm): T15, T20 (L=80 mm); CrV;



No.	pcs	box
65705	10	5/80

PL Zestaw końcówek śrubokrętowych
 GB Screwdriver bit set
 D Schraubendreherbitsatz
 RUS Набор битов

CZ Sada bitů
 RO Truse bit
 H Bitkészlet
 E Puntas de destornilladora

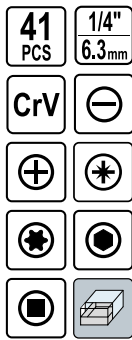

- 1/4" (6.3 mm): 3, 4, 5, 5.5, 6, 7 mm (L=25 mm); CrV;
- 1/4" (6.3 mm): PH0, PH1 x2, PH2 x4, PH3 (L=25 mm); CrV;
- 1/4" (6.3 mm): PZ0, PZ1 x2, PZ2 x4, PZ3 (L=25 mm); CrV;
- 1/4" (6.3 mm): T10, T15, T20, T25, T27, T30, T40 (L=25 mm); CrV;
- 1/4" (6.3 mm): 2, 2.5, 3, 4, 5, 5.5, 6 mm (L=25 mm); CrV;
- 1/4" (6.3 mm): S0, S1, S2, S3 (L=25 mm); CrV;
- 1/4" (6.3 mm): (L=80 mm); CrV;



No.	pcs	box
66301	41	10/40

PL Końcówki śrubokrętowe do gipsów
 GB Screwdriver bit set
 D Phillips-Bits mit Schutz PH2
 RUS Насадки для быстрого завинчивания саморезов по гипскартону

CZ Koncovky šroubovavkové na sádro
 RO Capete pt. ghips pt. surubelnită
 H Csavarhúzóvégék gipszhez
 E Puntas con limitador ph2 escayola



- 1/4" (6.3 mm): PH2 (L=25 mm)



No.	pcs	box
65800	2	12/144

PL Zestaw końcówek śrubokrętowych
 GB Screwdriver bit set
 D Schraubendreherbitsatz
 RUS Набор битов

CZ Sada bitů
 RO Truse bit
 H Bitkészlet
 E Puntas de destornilladora

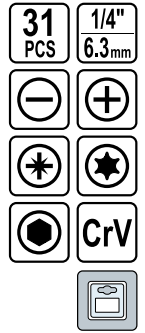

- 1/4" (6.3 mm): 3, 4, 5, 5.5, 6, 7 mm (L=25 mm); CrV;
- 1/4" (6.3 mm): PH0, PH1 x2, PH2 x2, PH3 (L=25 mm); CrV;
- 1/4" (6.3 mm): PZ0, PZ1 x2, PZ2 x2, PZ3 (L=25 mm); CrV;
- 1/4" (6.3 mm): T10, T15, T20, T25, T27, T30 (L=25 mm); CrV;
- 1/4" (6.3 mm): 2, 3, 4, 5, 5.5, 6 mm (L=25 mm); CrV;
- 1/4" (6.3 mm): (L=80 mm); CrV;



No.	pcs	box
66302	31	10/30

PL Zestaw końcówek śrubokrętowych
 GB Screwdriver bit set
 D Schraubendreherbitsatz
 RUS Набор битов

CZ Sada bitů
 RO Truse bit
 H Bitkészlet
 E Puntas de destornilladora

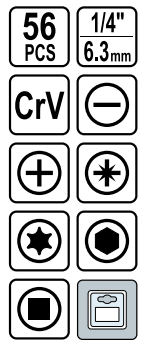

- 1/4" (6.3 mm): 3, 4, 5, 5.5, 6, 7 mm (L=25 mm); CrV;
- 1/4" (6.3 mm): PH0, PH1 x2, PH2 x5, PH3 (L=25 mm); PH1, PH2, PH3 (L=50 mm); CrV;
- 1/4" (6.3 mm): PZ0, PZ1 x2, PZ2 x5, PZ3 (L=25 mm); PZ1, PZ2, PZ3 (L=50 mm); CrV;
- 1/4" (6.3 mm): T10, T15, T20, T25, T27, T30, T40 (L=25 mm); T15, T20, T25 (L=50 mm); CrV;
- 1/4" (6.3 mm): 2, 2.5, 3, 4, 5, 5.5, 6 mm (L=25 mm); 4, 5, 6 mm (L=50 mm); CrV;
- 1/4" (6.3 mm): S0, S1, S2, S3 (L=25 mm); CrV;



No.	pcs	box
66310	56	8/16

PL Zestaw końcówek śrubokrętowych
 GB Screwdriver bit set
 D Schraubendreherbitsatz
 RUS Набор битов

CZ Sada bitů
 RO Truse bit
 H Bitkészlet
 E Puntas de destornilladora

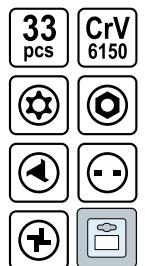

- 1/4" (6.3 mm): T8, T10, T15, T20, T25, T27, T30, T35, T40 (L=25 mm);
- 1/4" (6.3 mm): 5/64 (2.0 mm), 3/32 (2.4 mm), 7/64 (2.8 mm); 1/8 (3.2 mm), 9/64 (3.6 mm), 5/32 (4.0 mm) (L=25 mm);
- 1/4" (6.3 mm): 2, 2.5, 3, 4, 5, 6 mm (L=25 mm);
- 1/4" (6.3 mm): 1, 2, 3, 4 (L=25 mm);
- 1/4" (6.3 mm): 6, 8, 10 (L=25 mm);
- 1/4" (6.3 mm): 4, 6, 8, 10 (L=25 mm);
- 1/4" (6.3 mm): (L=80 mm);



No.	pcs	box
66330	33	12/60

PL Zestaw końcówek śrubokrętowych
 GB Screwdriver bit set
 D Schraubendreherbitsatz
 RUS Набор бит с шлицами

CZ Sada bitů
 RO Truse bit
 H Bitkészlet
 E Juego de llaves especiales



VOREL

3/8" (9.5 mm): T20, T25, T30, T40, T45, T50, T55 (L=30 mm); 3/8" (9.5 mm): T20, T25, T30, T40, T45, T50, T55 (L=75 mm); 3/8" (9.5 mm): 4, 5, 6, 7, 8, 10, 12 (L=30 mm); 3/8" (9.5 mm): 4, 5, 6, 7, 8, 10, 12 (L=75 mm); 3/8" (9.5 mm): M5, M6, M8, M10, M12 (L=30 mm); 3/8" (9.5 mm): M5, M6, M8, M10, M12 (L=75 mm); 1/2" (12.7 mm) x 3/8" (9.5 mm); 3/8" (9.5 mm) x 3/8" (9.5 mm)

No.	pcs	☐
66400	40	10

PL Zestaw końcówek śrubokrętowych
 GB Screwdriver bit set
 D Schraubendreherbitsatz
 RUS Набор специальных бит

CZ Sada bitů
 RO Truse bit
 H Bitkészlet
 E Juego de llaves especiales



VOREL

3/8" (9.5 mm): T25, T30, T40, T45, T50, T55 (L=30 mm); 1/2" (12.7 mm) x 3/8" (9.5 mm)

No.	pcs	☐
66570	7	24/72

PL Zestaw końcówek śrubokrętowych
 GB Screwdriver bit set
 D Schraubendreherbitsatz
 RUS Набор специальных бит

CZ Sada bitů
 RO Truse bit
 H Bitkészlet
 E Juego de llaves especiales

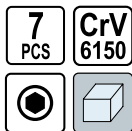

VOREL

3/8" (9.5 mm): 4, 5, 6, 8, 10, 12 mm (L=30 mm); 1/2" (12.7 mm) x 3/8" (9.5 mm)

No.	pcs	☐
66710	7	24/72

PL Zestaw końcówek śrubokrętowych
 GB Screwdriver bit set
 D Schraubendreherbitsatz
 RUS Набор специальных бит

CZ Sada bitů
 RO Truse bit
 H Bitkészlet
 E Juego de llaves especiales

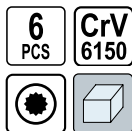

VOREL

3/8" (9.5 mm): M5, M6, M8, M10, M12 mm (L=30 mm); 1/2" (12.7 mm) x 3/8" (9.5 mm)

No.	pcs	☐
66760	6	24/72

PL Zestaw końcówek śrubokrętowych
 GB Screwdriver bit set
 D Schraubendreherbitsatz
 RUS Набор бит с шлицами

CZ Sada bitů
 RO Truse bit
 H Bitkészlet
 E Juego de llaves especiales

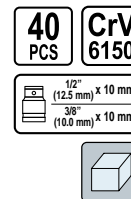

VOREL

30 mm: T20; T25; T30; T40; T45; T50; T55, 75 mm: T20; T25; T30; T40; T45; T50; T55, 30 mm: H4; H5; H6; H7; H8; H10; H12, 75 mm: H4; H5; H6; H7; H8; H10; H12, 30 mm: M5; M6; M8; M10; M12, 75 mm: M5; M6; M8; M10; M12

No.	pcs	☐
66410	40	10

PL Zestaw końcówek śrubokrętowych
 GB Screwdriver bit set
 D Schraubendreherbitsatz
 RUS Набор специальных бит

CZ Sada bitů
 RO Truse bit
 H Bitkészlet
 E Juego de llaves especiales

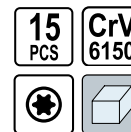

VOREL

3/8" (9.5 mm): T20, T25, T30, T40, T45, T50, T55 (L=30 mm); 3/8" (9.5 mm): T20, T25, T30, T40, T45, T50, T55 (L=75 mm); 1/2" (12.7 mm) x 3/8" (9.5 mm)

No.	pcs	☐
66580	15	20

PL Zestaw końcówek śrubokrętowych
 GB Screwdriver bit set
 D Schraubendreherbitsatz
 RUS Набор специальных бит

CZ Sada bitů
 RO Truse bit
 H Bitkészlet
 E Juego de llaves especiales

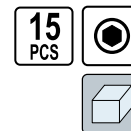

VOREL

3/8" (9.5 mm): 4, 5, 6, 7, 8, 10, 12 (L=30 mm); 3/8" (9.5 mm): 4, 5, 6, 7, 8, 10, 12 (L=75 mm); 1/2" (12.7 mm) x 3/8" (9.5 mm)

No.	pcs	☐
66720	15	20

PL Zestaw końcówek śrubokrętowych
 GB Screwdriver bit set
 D Schraubendreherbitsatz
 RUS Набор специальных бит

CZ Sada bitů
 RO Truse bit
 H Bitkészlet
 E Juego de llaves especiales

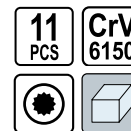

VOREL

3/8" (9.5 mm): M5, M6, M8, M10, M12 mm (L=30 mm); 3/8" (9.5 mm): M5, M6, M8, M10, M12 mm (L=75 mm); 1/2" (12.7 mm) x 3/8" (9.5 mm)

No.	pcs	☐
66770	11	20

PL Zestaw końcówek śrubokrętowych
 GB Screwdriver bit set
 D Schraubendreherbitsatz
 RUS Набор бит с магнитным адаптером

CZ Sada bitů
 RO Truse bit
 H Bitkészlet
 E Juego de llaves especiales

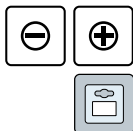

No.	pcs	☐
66080	7	20/200

PL Zestaw końcówek śrubokrętowych
 GB Screwdriver bit set
 D Schraubendreherbitsatz
 RUS Набор бит с магнитным адаптером
 CZ Sada bitů
 RO Truse bit
 H Bitkészlet
 E Juego de llaves especiales

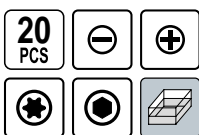

No.	pcs	☐
66210	20	12/48

PL Uchwyt do końcówek śrubokrętowych
 GB Screwdriver bit holder
 D Bithalter
 RUS Адаптер для бит магнитный

CZ Držák na šroubovavkové koncovky
 RO Capete șurubelniță
 H Szár a csavarhúzóvégekhöz
 E Mandril para puntas



No.	☐
65850	30/300

PL Adapter kątowy
 GB Angle adapter
 D Winkelschrauber
 RUS Адаптер угловой для бит
 CZ Úhel elektrická vrtačka připojení adaptéru
 RO Dispozitiv unghiular de insurubat
 H Sarokcsavarozó adapter
 E Ángulo magnético bit driver adaptador



No.	☐	L (mm)	☐
65840	1/4" (6.3 mm)	130	60

PL Zestaw końcówek śrubokrętowych
 GB Screwdriver bit set
 D Schraubendreherbitsatz
 RUS Набор двусторонних бит в держателе

CZ Sada bitů
 RO Truse bit
 H Bitkészlet
 E Juego de llaves especiales

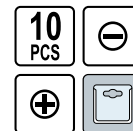

No.	pcs	☐
66112	10	25/100

PL Zestaw końcówek śrubokrętowych
 GB Screwdriver bit set
 D Schraubendreherbitsatz
 RUS Набор бит с магнитным адаптером

CZ Sada bitů
 RO Truse bit
 H Bitkészlet
 E Juego de llaves especiales



No.	pcs	☐
66200	20	12/48

PL Komplet końcówek nasadowych
 GB Screwdriver bit set
 D Bit-Steckschlüsselsatz
 RUS Набор торцевых головок

CZ Sada nastrůných koncovek
 RO Set de capete tubulare
 H Csőkulcskészlet
 E Juego de puntas de calar

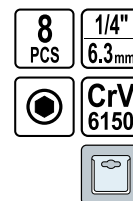

☐ ☐ ☐ ☐ 1/4" (6.3 mm): 5, 6, 7, 8, 9, 10, 11, 13 mm; CrV 6150

No.	pcs	☐
66113	8	25/100



PL Klucz sześciokątny CZ Imbusový klíč
 GB Hex key RO Cheie imbus
 D Sechskant-Stiftschlüssel H Imbisz kulcs
 RUS Шестигранный E Llave hexagonal



No.	mm	
56040	4	1000/2000
56050	5	400/800
56060	6	400/800
56070	7	300/600
56080	8	200/400
56100	10	100/200
56120	12	50/100
56130	13	50/100
56140	14	50/100
56170	17	25/50

PL Zestaw kluczy imbusowych CZ Imbusové klíče
 GB Hex key set RO Cheie imbus
 D Sechskant-Stiftschlüsselsatz H Imbisz kulcs
 RUS Набор шестигранных E Juego de llaves hex

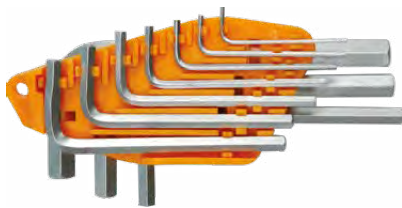

No.	mm	pcs	
56393	1.5; 2; 2.5; 3; 4; 5; 5.5; 6; 8; 10	10	10/60

PL Zestaw kluczy imbusowych CZ Imbusové klíče
 GB Hex key set RO Cheie imbus
 D Sechskant-Stiftschlüsselsatz H Imbisz kulcs
 RUS Набор шестигранных с шаром E Juego de llaves hex



No.	mm	pcs	
56470	2.5; 3; 4; 5; 6; 8; 10	7	20/40

PL Zestaw kluczy imbusowych CZ Imbusové klíče
 GB Hex key set RO Cheie imbus
 D Sechskant-Stiftschlüsselsatz H Imbisz kulcs
 RUS Набор шестигранных E Juego de llaves hex

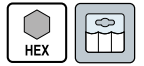

No.	mm	pcs	
56380	2-10	8	20/100
56390	1.5-10	10	20/100

PL Zestaw kluczy imbusowych CZ Imbusové klíče
 GB Hex key set RO Cheie imbus
 D Sechskant-Stiftschlüsselsatz H Imbisz kulcs
 RUS Набор шестигранных E Juego de llaves hex



No.	mm	pcs	
56391	1.5-10	10	20/100
56392	2-10	8	20/100

PL Zestaw kluczy imbusowych CZ Imbusové klíče
 GB Hex key set RO Cheie imbus
 D Sechskant-Stiftschlüsselsatz H Imbisz kulcs
 RUS Набор шестигранных E Juego de llaves hex



No.	mm	pcs	
56400	2-14	10	20/40

PL Zestaw kluczy imbusowych CZ Imbusové klíče
 GB Hex key set RO Cheie imbus
 D Sechskant-Stiftschlüsselsatz H Imbisz kulcs
 RUS Набор шестигранных с шаром E Juego de llaves hex

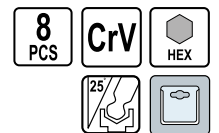

No.	mm	pcs	
56473	1.5; 2; 2.5; 3; 4; 5; 6; 8	8	10/60

PL Zestaw kluczy imbusowych CZ Imbusové klíče
 GB Hex key set RO Chei imbus
 D Sechkant-Stiftschluselsatz H Imbissz kulcs
 RUS Набор шестигранных с шаром E Juego de llaves hex

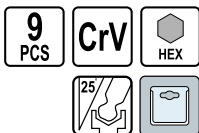

No.	mm	pcs	
56475	2.5; 3; 4; 5; 5.5; 6; 7; 8; 10	9	10/60

PL Zestaw kluczy imbusowych CZ Imbusové klíče
 GB Hex key set RO Chei imbus
 D Sechkant-Stiftschluselsatz H Imbissz kulcs
 RUS Набор шестигранных с шаром E Juego de llaves hex

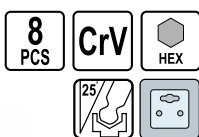

No.	mm	pcs	
56505	1.5; 2; 2.5; 3; 4; 5; 6; 8	8	25/100

PL Zestaw kluczy imbusowych CZ Imbusové klíče
 GB Hex key set RO Chei imbus
 D Sechkant-Stiftschluselsatz H Imbissz kulcs
 RUS Набор шестигранных E Juego de llaves hex



No.	mm	size / rozmiar	pcs	
56550	1.3; 1.5; 2; 2.5; 3; 3.5; 4; 5; 5.5; 6; 7; 8; 10	1/20" (1.2 mm); 1/16" (1.6 mm); 5/64" (2.0 mm); 3/32" (2.4 mm); 7/64" (2.8 mm); 1/8" (3.2 mm); 5/32" (4.0 mm); 3/16" (4.8 mm); 7/32" (5.6 mm); 1/4" (6.3 mm); 5/16" (7.9 mm); 3/8" (9.5 mm)	25	25/50

PL Zestaw kluczy Torx CZ Souprava klíčů Torx
 GB Torx key set RO Set de chei Torx
 D Torx-Stiftschluselsatz H Kulcskészlet, Torx
 RUS Набор ключей Torx E Juego de llaves Torx



No.		pcs	
56600	T10-T40	8	50/100

PL Zestaw kluczy imbusowych CZ Imbusové klíče
 GB Hex key set RO Chei imbus
 D Sechkant-Stiftschluselsatz H Imbissz kulcs
 RUS Набор шестигранных с шаром E Juego de llaves hex

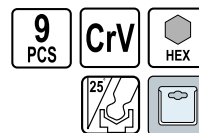

No.	mm	pcs	
56477	2; 2.5; 3; 4; 5; 5.5; 6; 8; 10	9	10/60

PL Zestaw kluczy imbusowych CZ Imbusové klíče
 GB Hex key set RO Chei imbus
 D Sechkant-Stiftschluselsatz H Imbissz kulcs
 RUS Набор шестигранных E Juego de llaves hex

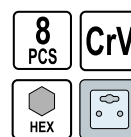

No.	mm	pcs	
56506	1.5; 2; 2.5; 3; 4; 5; 6; 8	8	25/100

PL Zestaw kluczy Torx CZ Souprava klíčů Torx
 GB Torx key set RO Set de chei Torx
 D Torx-Stiftschluselsatz H Kulcskészlet, Torx
 RUS Набор ключей Torx E Juego de llaves Torx

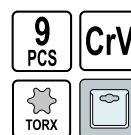

No.		pcs	
56478	T10; T15; T20; T25; T27; T30; T40; T45; T50	9	20/40

PL Zestaw kluczy Torx CZ Souprava klíčů Torx
 GB Torx key set RO Set de chei Torx
 D Torx-Stiftschluselsatz H Kulcskészlet, Torx
 RUS Набор ключей Torx E Juego de llaves Torx

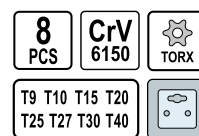

No.		pcs	
56507	T9 T10 T15 T20 T25 T27 T30 T40	8	25/100

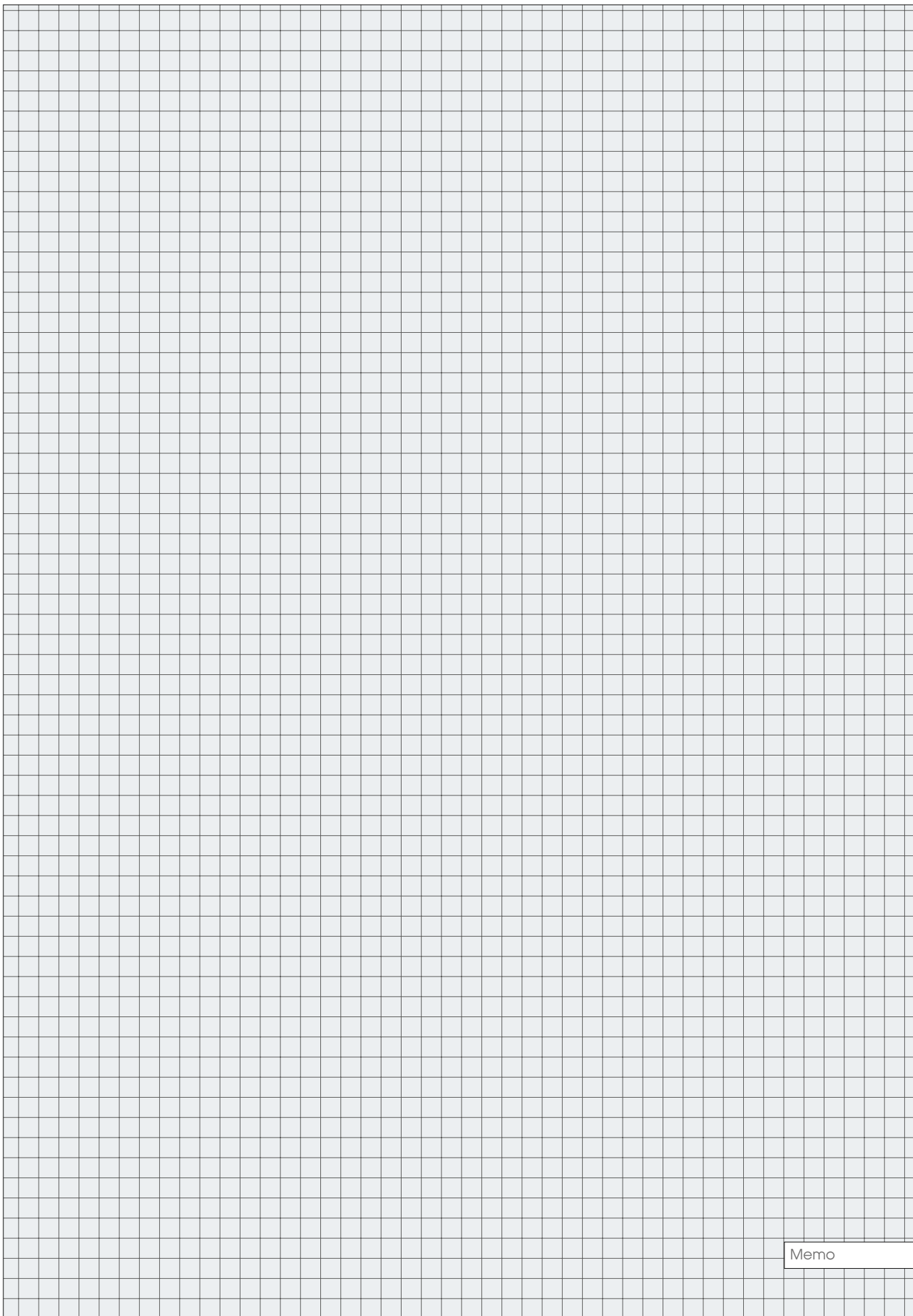

Memo

4

Pliers & pipe wrenches Szczypce i klucze do rur



Pliers, heavy duty blue handle Szczypce, uchwyt niebieski

48



Combination pliers Szczypce uniwersalne.....	48
Side cutting pliers Szczypce tnące, boczne.....	48
Long nose pliers Szczypce wydłużone, proste.....	48
Bent nose pliers Szczypce wydłużone, wygięte.....	48

Pliers, 2 colour handle Szczypce, dwukolorowa rączka

48-49

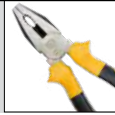

Combination pliers Szczypce uniwersalne.....	48
Side cutting pliers Szczypce tnące, boczne.....	48
Long nose pliers Szczypce wydłużone, proste.....	48
Bent nose pliers Szczypce wydłużone, wygięte.....	48
Round nose pliers Szczypce okrągłe.....	49
Wire stripping pliers Szczypce do ściągania izolacji.....	49
End cutting pliers Szczypce tnące, czołowe.....	49
Water pump pliers Szczypce nastawne.....	49

Chrome plated pliers Szczypce chromowane

49



Water pump pliers Szczypce nastawne.....	49
--	----

Pincers & pliers Szczypce i obcęgi

49-50



End cutting pliers Szczypce tnące, czołowe.....	49
Carpenter's pincers Obcęgi.....	49
Tower pincers Szczypce tynkarskie.....	50

Profile connection pliers Szczypce do łączenia profili

50



Pliers „Juco” Szczypce „Juco”

50



Combination pliers Szczypce uniwersalne.....	50
Side cutting pliers Szczypce tnące, boczne.....	50

Mini pliers Szczypce „Mini”

50-51



Combination pliers Szczypce uniwersalne.....	50
Side cutting pliers Szczypce tnące, boczne.....	50
Long nose pliers Szczypce wydłużone, proste.....	50
Bent nose pliers Szczypce wydłużone, wygięte.....	51
Flat nose pliers Szczypce płaskie.....	51
Round nose pliers Szczypce okrągłe.....	51
End cutting pliers Szczypce tnące, czołowe.....	51
Mini pliers sets Zestawy szczypiec „Mini”.....	51

Circlip pliers Szczypce Segera

51-53



Lock grip pliers Szczypce zaciskowe

53



Water pump pliers Szczypce nastawne

54



Pipe wrenches Klucze do rur

54-55



Pipe wrenches Stillson type Klucze do rur typu Stillson.....	54
Adjustable pipe wrenches Klucze do rur nastawne.....	54
Adjustable wrenches Klucze nastawne francuskie.....	55

Chain pipe wrenches Klucze do rur łańcuchowe

55



PL Szczypce uniwersalne
GB Combination pliers
D Kombinationszange
RUS Плоскогубцы универсальные

CZ Univerzální kleště
RO Patent universal
H Kombinálfogó
E Alicates universal



VOREL

No.	L (mm)	
40010	160	6/60
40011	180	6/60
40012	200	6/60

PL Szczypce wydłużone proste
GB Long nose pliers
D Radiozange
RUS Тонкогубцы

CZ Prodloužené kleště rovné
RO Patent drept alungit
H Rádíofogó, egyenes
E Alicates de punta



VOREL

No.	L (mm)	
40013	160	6/120
40014	200	6/60

PL Szczypce uniwersalne
GB Combination pliers
D Kombinationszange
RUS Плоскогубцы универсальные

CZ Univerzální kleště
RO Patent universal
H Kombinálfogó
E Alicates universal



VOREL

No.	L (mm)	
40041	160	6/60
40042	180	6/60
40043	200	6/60

PL Szczypce wydłużone proste
GB Long nose pliers
D Radiozange
RUS Тонкогубцы

CZ Prodloužené kleště rovné
RO Patent drept alungit
H Rádíofogó, egyenes
E Alicates de punta



VOREL

No.	L (mm)	
40044	160	6/120
40045	180	6/60

PL Szczypce tnące boczne
GB Diagonal side cutting pliers
D Seitenschneider
RUS Бокорезы

CZ Řezací kleště boční
RO Patent de tăiat lateral
H Oldal csípőfogó
E Alicates corte lateral



VOREL

No.	L (mm)	
40017	160	6/60
40018	180	6/60

PL Szczypce wydłużone wygięte
GB Bent nose pliers
D Telefonzange
RUS Тонкогубцы изогнутые

CZ Prodloužené kleště ohnuté
RO Patent curbat alungit
H Rádíó- és telefonfogó, hajlítót
E Alicates curvos



VOREL

No.	L (mm)	
40015	160	6/120
40016	200	6/60

PL Szczypce tnące boczne
GB Diagonal side cutting pliers
D Seitenschneider
RUS Бокорезы

CZ Řezací kleště boční
RO Patent de tăiat lateral
H Oldal csípőfogó
E Alicates corte lateral



VOREL

No.	L (mm)	
40047	160	6/60
40048	180	6/60

PL Szczypce wydłużone wygięte
GB Bent nose pliers
D Telefonzange
RUS Тонкогубцы изогнутые

CZ Prodloužené kleště ohnuté
RO Patent curbat alungit
H Rádíó- és telefonfogó, hajlítót
E Alicates curvos



VOREL

No.	L (mm)	
40050	160	6/120
40051	180	6/60

PL Szcypce okrągłe
GB Round nose pliers
D Rundzange
RUS Круглогубцы

CZ Kruhové kleště
RO Patent rotund
H Kerekcsőrű fogó
E Alicates redondos

160 mm



No.	L (mm)	
40054	160	6/120

PL Szcypce tnące czolowe
GB End cutting pliers
D Vorschneider
RUS Кусачки торцевые

CZ Řezací kleště čelní
RO Clește de tăiat frontal
H Homlok csípőfogó
E Alicates corte frontal

160 mm



No.	L (mm)	
40055	160	6/60

PL Szcypce nastawne
GB Water pump pliers
D Wasserpumpenzange
RUS Клещи переставные

CZ Hydraulické kleště nastavitelné
RO Clește instalator tip papagal
H Állítható csőfogó
E Alicates de fontanero

250 mm

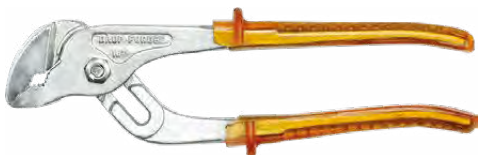

No.	L (mm)	
41500	250	6/60

PL Obcęgi
GB Carpenter's pincers
D Kneifzange
RUS Клещи строительные

CZ Kleště
RO Clește
H Harapófogó
E Tenazas



No.	L (mm)	
41151	180	6/60
41152	200	6/60

PL Szcypce do ściągania izolacji
GB Wire stripping pliers
D Abisolierzange
RUS Клещи для снятия изоляции

CZ Kleště na sundávání izolace
RO Patent pt. decablat
H Szigeteléseltávolító fogó
E Pinzas pelacables

160 mm



No.	L (mm)	
40056	160	6/60

PL Szcypce nastawne
GB Water pump pliers
D Wasserpumpenzange
RUS Клещи переставные

CZ Hydraulické kleště nastavitelné
RO Clește instalator tip papagal
H Állítható csőfogó
E Alicates de fontanero

250 mm



No.	L (mm)	
40057	250	6/60

PL Szcypce tnące czolowe
GB End cutting pliers
D Vorschneider
RUS Кусачки торцевые

CZ Řezací kleště čelní
RO Clește de tăiat frontal
H Homlok csípőfogó
E Alicates corte frontal

180 mm



No.	L (mm)	
41121	180	6/60

PL Obcęgi
GB Carpenter's pincers
D Kneifzange
RUS Клещи строительные

CZ Kleště
RO Clește
H Harapófogó
E Tenazas



No.	L (mm)	
41180	180	6/120
41200	200	6/60

4

PL Obcegi tynkarskie
GB Tower pincers
D Beisszange
RUS Клеши штукатурные

CZ Kleště štípací čelní
RO Clește pt. cuie
H Rabitzfogó
E Tenazas de enlucido

250 mm



VOREL

No.	L (mm)	
41381	250	6/60

PL Szczypce do łączenia profili
GB Profile connection pliers
D Zange zum Verbinden der Profile
RUS Щипцы для соединения профилей

CZ Kleště ke spojování profilů
RO Clește pt. îmbinarea profilelor
H Profilegyesítő fogó
E Pinzas para conectar perfiles

300 mm



VOREL

No.	L (mm)	
04301	300	6/24

PL Szczypce tnące boczne
GB Diagonal side cutting pliers
D Seitenschneider
RUS Бокорезы

CZ Řezací kleště boční
RO Patent de tăiat lateral
H Oldal csípőfogó
E Alicates corte lateral

1000 V 160 mm



JUKO

No.	L (mm)	V	
40700	160	1000	5/50

PL Szczypce tnące boczne
GB Diagonal side cutting pliers
D Seitenschneider
RUS Бокорезы

CZ Řezací kleště boční
RO Patent de tăiat lateral
H Oldal csípőfogó
E Alicates corte lateral

110 mm



VOREL

No.	L (mm)	
42301	110	12/120

PL Szczypce do łączenia profili
GB Profile connection pliers
D Zange zum Verbinden der Profile
RUS Щипцы для соединения профилей

CZ Kleště ke spojování profilů
RO Clește pt. îmbinarea profilelor
H Profilegyesítő fogó
E Pinzas para conectar perfiles

280 mm

65 Mn (PUNCH)



VOREL

No.	L (mm)	
04300	280	6/36

PL Szczypce uniwersalne
GB Combination pliers
D Kombinationszange
RUS Плоскогубцы универсальные

CZ Univerzální kleště
RO Patent universal
H Kombinaltfogó
E Alicates universal

1000 V



JUKO

No.	L (mm)	V	
40160	160	1000	10/50
40180	180	1000	10/50
40200	200	1000	10/50

PL Szczypce uniwersalne
GB Combination pliers
D Kombinationszange
RUS Плоскогубцы

CZ Univerzální kleště
RO Patent universal
H Kombinaltfogó
E Alicates universal

120 mm



VOREL

No.	L (mm)	
42300	120	12/120

PL Szczypce wydłużone proste
GB Long nose pliers
D Radiozange
RUS Тонкогубцы

CZ Prodloužené kleště rovné
RO Patent drept alungit
H Rádiófogó, egyenes
E Alicates de punta

125 mm



VOREL

No.	L (mm)	
42303	125	12/120

PL Szczypce wydłużone proste CZ Prodloužené kleště rovné
 GB Long nose pliers RO Patent drept alungit
 D Radiozange H Rádíofogó, egyenes
 RUS Тонкогубцы E Alicates de punta



No.	L (mm)	Box
42305	150	12/120

PL Szczypce płaskie CZ Prodloužené kleště rovné
 GB Flat nose pliers RO Clește cu vârf ascuțit
 D Elektrikerflachzange H Rádíofogó, egyenes
 RUS Утконосы E Alicates de bocas planas



No.	L (mm)	Box
42306	120	12/120

PL Szczypce tnące czołowe CZ Řezací kleště čelní
 GB End cutting pliers RO Clește de tăiat frontal
 D Vorschneider H Homlok csípőfogó
 RUS Кусачки торцевые E Alicates corte frontal



No.	L (mm)	Box
42302	110	12/120

PL Zestaw mini szczypiec CZ Elektronické kleště
 GB Mini pliers set RO Set mini patenti si clesti
 D Mini-Zangensatz H Elektronikai fogó
 RUS Пассатижи в наборе E Alicates electronicas



No.	pcs	Box
42309	6	4/40

PL Szczypce wydłużone wygięte CZ Prodloužené kleště ohnuté
 GB Bent nose pliers RO Patent curbait alungit
 D Telefonzange H Rádíó- és telefonfogó hajlítót
 RUS Тонкогубцы изогнутые E Alicates curvos

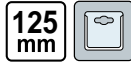

No.	L (mm)	Box
42304	125	12/120

PL Szczypce okrągłe CZ Kruhové kleště
 GB Round nose pliers RO Patent rotund
 D Rundzange H Kerekcsőrű fogó
 RUS Круглогубцы E Alicates redondos

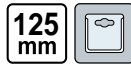

No.	L (mm)	Box
42307	125	12/120

PL Zestaw mini szczypiec CZ Elektronické kleště
 GB Mini pliers set RO Set mini patenti
 D Mini-Zangensatz H Elektronikai fogó
 RUS Пассатижи в наборе E Alicates electronicas



No.	pcs	Box
42308	4	5/50

PL Szczypce Segera, zewnętrzne proste CZ Kleště Segera vnější rovné
 GB Circlip pliers, external straight RO Clește Seger exterior drept
 D Seegeringzange aussen. ger. H Segerfogó külső, egyenes
 RUS Съёмник стопорных колец (разжим) E Alicates Seger extler. de punta



No.	L (mm)	Box
43010	150	6/120
43011	200	6/120

PL Szczypce Segera, zewnętrzne wygięte CZ Kleště Segera vnější ohnuté
 GB Circlip pliers, external bent RO Clește Seger exterior curbat
 D Seegeringzange aussen. geb. H Seegerfogó külső, hajlított
 RUS Съёмник стопорных колец (разжим)-изогнутый E Alicates seger exter. curvos



No.	L (mm)	Icon
43020	150	6/120
43021	200	6/120

PL Szczypce Segera, wewnętrzne wygięte CZ Kleště Segera vnitřní ohnuté
 GB Circlip pliers, internal bent RO Patent seger interior curbat
 D Seegeringzange inner. geb. H Seegerfogó belső, hajlított
 RUS Съёмник стопорных колец (сжим)-изогнутый E Alicates Seger inter. curvos



No.	L (mm)	Icon
43040	150	6/120
43041	200	6/120

PL Szczypce Segera, zewnętrzne proste CZ Kleště Segera vnější rovné
 GB Circlip pliers, external straight RO Clește Seger exterior drept
 D Seegeringzange aussen. ger. H Seegerfogó külső, egyenes
 RUS Съёмник стопорных колец (разжим) E Alicates seger exter. de punta



No.	L (mm)	Icon
43051	160	6/60
43056	180	6/60
43061	200	6/60

PL Szczypce Segera, wewnętrzne proste CZ Kleště Segera vnitřní rovné
 GB Circlip pliers, internal straight RO Patent Seger interior drept
 D Seegeringzange inner. geb. H Seegerfogó belső, hajlított
 RUS Набор съёмников стопорных колец (сжим) E Alicates Seger inter. curvos



No.	L (mm)	Icon
43053	160	6/60
43058	180	6/60
43063	200	6/60

PL Szczypce Segera, wewnętrzne proste CZ Kleště Segera vnitřní rovné
 GB Circlip pliers, internal straight RO Clește Seger interior drept
 D Seegeringzange inner. ger. H Seegerfogó belső, egyenes
 RUS Съёмник стопорных колец (сжим) E Alicates seger inter. de punta



No.	L (mm)	Icon
43030	150	6/120
43031	200	6/120

PL Szczypce Segera, zewnętrzne proste CZ Kleště Segera vnější rovné
 GB Circlip pliers, external straight RO Clește Seger exterior drept
 D Seegeringzange aussen. ger. H Seegerfogó külső, egyenes
 RUS Съёмник стопорных колец (разжим) E Alicates Seger exter. de punta



No.	L (mm)	Icon
43050	160	6/60
43055	180	6/60
43060	200	6/60

PL Szczypce Segera, wewnętrzne proste CZ Kleště Segera vnitřní rovné
 GB Circlip pliers, internal straight RO Clește Seger interior drept
 D Seegeringzange inner. ger. H Seegerfogó belső, egyenes
 RUS Набор съёмников стопорных колец (сжим) E Alicates seger inter. de punta



No.	L (mm)	Icon
43052	160	6/60
43057	180	6/60
43062	200	6/60

PL Szczypce Segera GB Circlip pliers set CZ Kleště Segera RO Set clești seger
 D Seegeringzangen Satz H Seegerfogó E Alicates seger
 RUS Набор съёмников стопорных колец

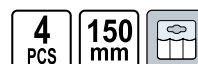

No.	L (mm)	pcs	Icon
43140	150	4	5/30

PL Szczypce Segera
 GB Circlip pliers set
 D Seegeringzangen Satz
 RUS Съёмник стопорных колец
 CZ Kleště Segera
 RO Clește pt. inele de siguranta + capete de schimb
 H Segerfogó
 E Alicates seger



No.	L (mm)	pcs	☐
43500	150	4	6/60

PL Szczypce Morse'a
 GB Lock grip pliers
 D Gripzange
 RUS Зажим ручной

CZ Kleště Morse'a
 RO Clește Morse
 H Morse fogó
 E Alicates Morse



No.	L (mm)	☐
44100	250	6/60

PL Szczypce spawalnicze
 GB Lock grip pliers
 D Schweisserzange
 RUS Клещи зажимные сварочные

CZ Svářečské kleště
 RO Clește autoblocant pt. sudura
 H Hegesztő fogó
 E Alicates de soldar



No.	L (mm)	type	☐
44300	275	C	6/36

PL Szczypce spawalnicze
 GB Lock grip pliers
 D Schweisserzange
 RUS Клещи зажимные сварочные

CZ Svářečské kleště
 RO Clește autoblocant pt. sudura
 H Hegesztő fogó
 E Alicates de soldar



No.	L (mm)	type	☐
44400	225	U	6/36

PL Szczypce Segera
 GB Circlip pliers set
 D Seegeringzangen Satz
 RUS Съёмник стопорных колец

CZ Kleště Segera
 RO Clește pt. inele de siguranta + capete de schimb
 H Segerfogó
 E Alicates seger

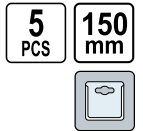

No.	L (mm)	pcs	☐
43510	150	5	6/60

PL Szczypce Morse'a
 GB Lock grip pliers
 D Gripzange
 RUS Зажим ручной

CZ Kleště Morse'a
 RO Clește Morse
 H Morse fogó
 E Alicates Morse



No.	L (mm)	☐
44102	250	6/36

PL Szczypce zaciskowe klamrowe typu „C”
 GB Welding locking pliers „C” type
 D Klemm- und Klammerzange vom Typ „C”
 RUS Клещи зажимные сварочные
 CZ Kleště samosvorné upínací typu „C”
 RO Clește de strângere cu clemă tip „C”
 H „C” fogó
 E Pinzas de tornillo (de apriete) de grapa tipo „C”



No.	L (mm)	type	☐
44301	280	C	6/30

PL Szczypce spawalnicze
 GB Lock grip pliers
 D Schweisserzange
 RUS Клещи зажимные сварочные

CZ Svářečské kleště
 RO Clește autoblocant pt. sudura
 H Hegesztő fogó
 E Alicates de soldar

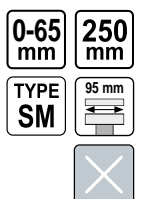

No.	L (mm)	type	☐
44500	250	SM	6/36

PL Szczypce hydrauliczne nastawne CZ Keleşte siko
 GB Water pump pliers RO Cleste papagal
 D Wasserpumpenzange H Vizpumpafagó
 RUS Ключи переставные E Alicates de fontanero ajustables



No.	L (mm)	jaw width / szerokość szczęk (mm)	
41510	250	9	10/50

PL Klucz do rur CZ Klíč součásti na trubky
 GB Pipe wrench RO Chei pt. țevi
 D Rohrschlüssel H Csőkulcs
 RUS Ключ трубный E Llave de fontanero



No.	L (mm)	
55620	195	6/36
55625	245	6/30
55630	275	6/24
55635	310	6/18
55645	395	4/12
55660	490	2/6
55690	750	2/4

PL Klucz nastawny do rur CZ Nastawitelný klíč na trubky
 GB Adjustable pipe wrench RO Cheie reglabilă pt. țevi
 D Rohrschlüssel H Állítható csőkulcs
 RUS Ключ трубный E Llave de vaso para tubería



No.	size / rozmiar	
55210	1.0" (25 mm)	24
55211	1.5" (38 mm)	16
55212	2.0" (50 mm)	8

PL Klucz nastawny do rur CZ Nastawitelný klíč na trubky
 GB Adjustable pipe wrench RO Cheie reglabilă pt. țevi
 D Rohrschlüssel H Állítható csőkulcs
 RUS Ключ трубный E Llave de vaso para tubería



PL Klucz do rur CZ Klíč součásti na trubky
 GB Pipe wrench RO Chei pt. țevi
 D Rohrschlüssel H Csőkulcs
 RUS Ключ трубный E Llave de fontanero



No.	L (mm)	
55250	250	6/48
55300	300	6/36
55350	350	6/24

PL Klucz nastawny do rur CZ Nastawitelný klíč na trubky
 GB Adjustable pipe wrench RO Cheie reglabilă pt. țevi
 D Rohrschlüssel H Állítható csőkulcs
 RUS Ключ трубный E Llave de vaso para tubería



No.	size / rozmiar	
55100	1.0" (25 mm)	12/36
55150	1.5" (38 mm)	10/20
55200	2.0" (50 mm)	6/12

PL Klucz nastawny do rur CZ Nastawitelný klíč na trubky
 GB Adjustable pipe wrench RO Cheie reglabilă pt. țevi
 D Rohrschlüssel H Állítható csőkulcs
 RUS Ключ трубный E Llave de vaso para tubería



No.	size / rozmiar	
55215	1.0" (25 mm)	24
55216	1.5" (38 mm)	16
55217	2.0" (50 mm)	8



No.	size / rozmiar	
55220	1.0" (25 mm)	24
55221	1.5" (38 mm)	16
55222	2.0" (50 mm)	8

PL Klucz nastawny francuski
 GB Adjustable wrench
 D Stahlschraubenschlüssel /franzose/
 RUS Ключ разводной

CZ Nastavitelný klíč francouz
 RO Cheie reglabilă franceză
 H Állítható franciakupcs
 E Llave ajustable inglesa



No.	KNF	jaws range / zakres szczęk (mm)	jaws width / szerokość szczęk (mm)	
54497	25	0-25	60	10
54498	35	0-55	70	10
54499	45	0-45	80	10
54500	55	0-55	90	5
54510	65	0-65	100	5

PL Klucz łańcuchowy do rur
 GB Chain pipe wrench
 D Kettenrohrzange
 RUS Цепной ключ для труб

CZ Klíč řetězový na trubky
 RO Cheie reglabilă pt. tevi cu lanț
 H Láncos csőfogó
 E Llave de cadena

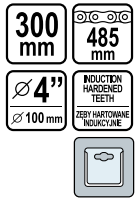

No.	L (mm)	max. pipe diameter / max. średnica rury	
55792	300	4" (100 mm)	10/30

Memo

5

Electrician tools Narzędzia dla elektryków

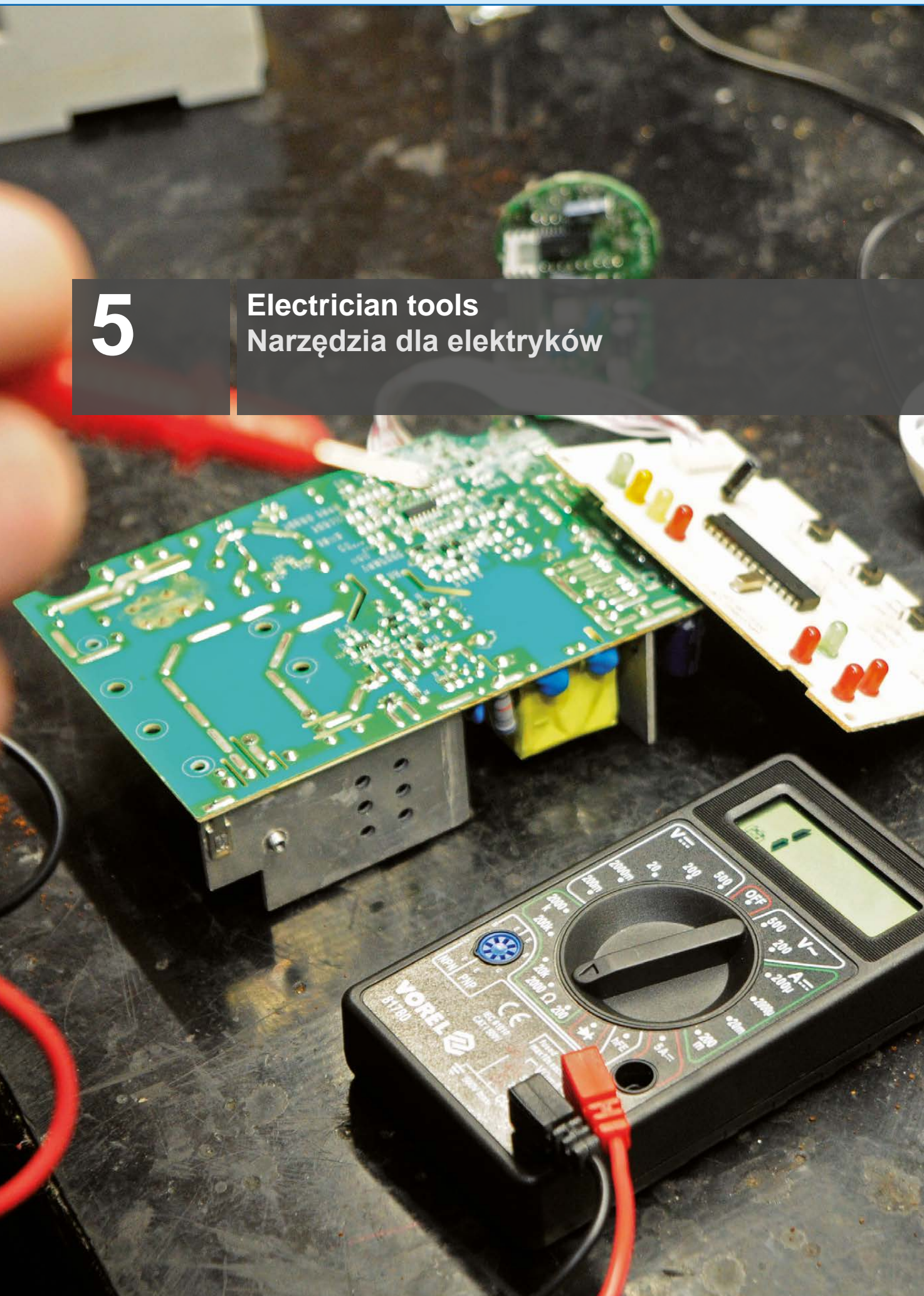

Crimping pliers
Szczypce do zaciskania
konektorów

58



Wire strippers
Ściągacze izolacji

58-59



Electrical cutters
Obcinaki elektryczne

59



Voltage testers
Próbniki napięcia

60



Digital universal meters
Cyfrowe mierniki uniwersalne

60-61



- PL Szczypce do zaciskania konektorów
- GB Ratchet crimping pliers
- D Kabelschuhzange
- RUS Инструмент для обжима и зачистки проводов
- CZ Kleště pro svěráni zaciskania konektorů
- RO Clește sertizat conectori
- H Krimpelő fogó
- E Pinzas de apretar de conectores



No.	□		○		☐
	mm ²	AWG	mm ²	AWG	
45500	0.5-2.5	20-14			12/36

- PL Ściągacz izolacji
- GB Wire stripper
- D Abisolierzange
- RUS Электронпассатижи
- CZ Odizolovací klejce
- RO Decablator
- H Blankolo fogo
- E Extractor de aislado

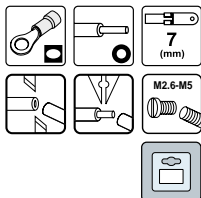

No.	□		○		☐
	mm ²	AWG	mm ²	AWG	
45000	1.5-6.0	22-10	0.75-6.0	22-10	12/120

- PL Ściągacz izolacji
- GB Wire stripper
- D Abisolierzange
- RUS Электронпассатижи
- CZ Odizolovací klejce
- RO Decablator
- H Blankolo fogo
- E Extractor de aislado

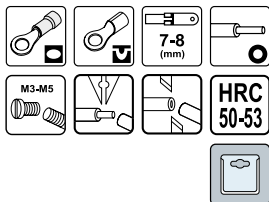

No.	□		◻		○		☐
	mm ²	AWG	mm ²	AWG	mm ²	AWG	
45012	0.64-2.6	26-10	0.8-2.6	22-10	0.64-2.6	26-10	12/72

- PL Szczypce do zaciskania konektorów
- GB Ratchet crimping pliers
- D Kabelschuhzange
- RUS Пассатижи для телефонных кабелей
- CZ Kleště pro svěráni zaciskania konektorů
- RO Clește sertizat conectori
- H Krimpelő fogó
- E Pinzas de apretar de conectores

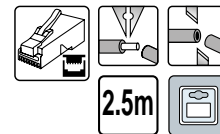

No.	□	☐
45503	RJ45, RJ11	10/40

- PL Zaciskacz z konektorami w kasecie
- GB Solderless terminal kit
- D Kabelschuhzange u. Kabelschuhe
- RUS Клеици для бжима + изолированные наконечники
- CZ Svěrka z konektorama v kazetě
- RO Set cleste mufare plus conectori
- H Prészerszám csatlakozókkal egy dobozban
- E Apretador con conectores en caja

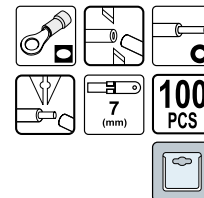

No.	□		○		pcs	☐
	mm ²	AWG	mm ²	AWG		
45050	1.5-6.0	22-10	1.5-6.0	22-10	100	25/50

- PL Ściągacz izolacji
- GB Wire stripper
- D Abisolierzange
- RUS Съёмник изоляции
- CZ Odizolovací klejce
- RO Decablator
- H Blankolo fogo
- E Extractor de aislado

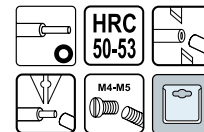

No.	○	☐
45010	0.8-2.6	22-10

PL Automacyjny ściągacz izolacji
GB Wire stripper / crimper
D Automatische Abisolierzange
RUS Клещи-автомат для снятия изоляции

CZ Automatický stahovač izolace
RO Decablator automat
H Automatikus szigeteléslehúzó
E Pelacables automatico

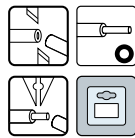

No.			Box
	mm ²	AWG	
45100	0.5-6.0	20-10	20/100

PL Uniwersalny ściągacz izolacji
GB Universal wire stripper
D Universal Abisolierzange
RUS Универсальный съёмник изоляции
CZ Univerzální odizolovací klejste
RO Decablator universal
H Blankolo fogo
E Extractor de aislado universal

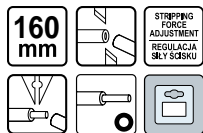

No.			Box
	mm ²	AWG	
45160	0.25	30	10/40

PL Obcinak elektryczny
GB Electrical cutter
D Seitenschneider
RUS Щипцы для резки проводов

CZ Elektrické upichovky ze stahovadlem
RO Clește tăietor - electrician
H Kábelvágó
E Cortacables eléctricos



No.	L (mm)	Box
45020	135	12/120

PL Automacyjny ściągacz izolacji
GB Wire stripper / crimper
D Automatische Abisolierzange
RUS Клещи-автомат для снятия изоляции

CZ Automatický stahovač izolace
RO Decablator automat
H Automatikus szigeteléslehúzó
E Pelacables automatico

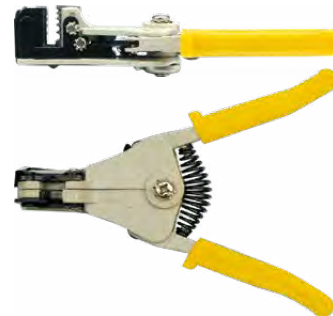
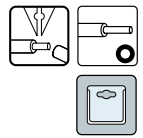

No.			Box
	mm ²	AWG	
45151	1.0-3.2	17-12	10/40

PL Automacyjny ściągacz z obcinakiem
GB Automatic wire stripper with cutter
D Automatische Abisolierzange + Schneider
RUS Клещи-автомат для снятия изоляции

CZ Automatický stahovač izolace
RO Decablator automat
H Automatikus szigeteléslehúzó
E Pelacables automatico

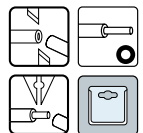

No.			Box
	mm ²	AWG	
45201	0.5-4.0	20-13	10/50

PL Nożyczki dla elektryków
GB Electrician scissors
D Elektrische Schere
RUS Ножницы электрика

CZ Univerzální nůžky
RO Foarfece universal
H Univerzális olló
E Tijeras universales



No.	L (mm)	Box
76320	140	12/120

PL Próbnik napięcia
GB Voltage tester
D Spannungsprüfer
RUS Отвёртка индикаторная

CZ Zkoušeč napětí
RO Creion de tensiune
H Fáziskereső
E Comprobador de corriente



VOREL

No.	L (mm)	
65233	140	12/1200

PL Cyfrowy miernik uniwersalny
GB Digital universal multimeter
D Universal digital Multimeter
RUS Универсальный цифровой мультиметр
CZ Digitální multimetr - univerzální
RO Multimetru digital universal
H Digitális multiméter
E Manómetor digital universal

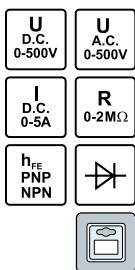

VOREL

No.	digit height / wysokość cyfr (mm)	
81780	12/72	

PL Cyfrowy miernik uniwersalny
GB Digital universal multimeter
D Universal digital Multimeter
RUS Универсальный цифровой мультиметр

CZ Digitální multimetr - univerzální
RO Multimetru digital universal
H Digitális multiméter
E Manómetor digital universal

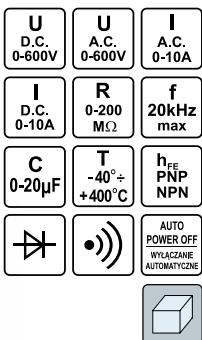

VOREL

No.	digit height / wysokość cyfr (mm)	
81784	25	20

PL Próbnik napięcia
GB Voltage tester
D Spannungsprüfer
RUS Отвёртка индикаторная

CZ Zkoušeč napětí
RO Creion de tensiune
H Fáziskereső
E Comprobador de corriente



VOREL

No.	L (mm)	
65235	190	12/600

PL Cyfrowy miernik uniwersalny
GB Digital universal multimeter
D Universal digital Multimeter
RUS Универсальный цифровой мультиметр

CZ Digitální multimetr - univerzální
RO Multimetru digital universal
H Digitális multiméter
E Manómetor digital universal

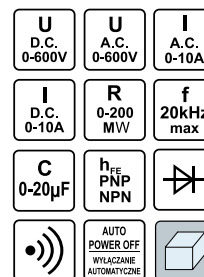

VOREL

No.	digit height / wysokość cyfr (mm)	
81783	25	20

PL Cyfrowy miernik uniwersalny
GB Digital universal multimeter
D Universal digital Multimeter
RUS Универсальный цифровой мультиметр

CZ Digitální multimetr - univerzální
RO Multimetru digital universal
H Digitális multiméter
E Manómetor digital universal

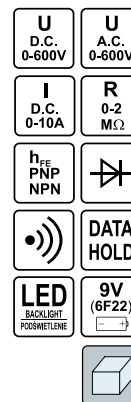

VOREL

No.	digit height / wysokość cyfr (mm)	
81773	50	

PL Cyfrowy miernik uniwersalny
 GB Digital universal multimeter
 D Universal digital Multimeter
 RUS Универсальный цифровой мультиметр

CZ Digitální multimetr - univerzální
 RO Multimetricu digital universal
 H Digitális multiméter
 E Manómetro digital universal

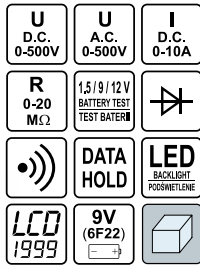

No.	
81774	50

PL Cęgowy miernik uniwersalny
 GB Clamp universal multimeter
 D Universell Klemme Messgerät
 RUS Универсальный цифровой измеритель

CZ Digitální multimetr - univerzální
 RO Multimetricu digital universal
 H Digitális multiméter
 E Manómetro digital universal

PL Cyfrowy miernik uniwersalny
 GB Digital universal multimeter
 D Universal digital Multimeter
 RUS Универсальный цифровой мультиметр

CZ Digitální multimetr - univerzální
 RO Multimetricu digital universal
 H Digitális multiméter
 E Manómetro digital universal

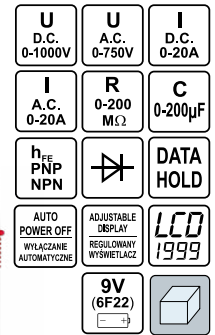

No.	
81775	40



No.	
81801	5/60

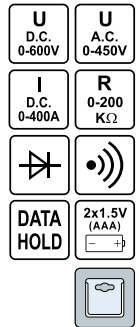

Memo									
------	--	--	--	--	--	--	--	--	--

6

Hammers, chisels, punches & axes Młotki, dłuta, przecinaki i siekiery



Machinist hammers Młotki ślusarskie



64-65

Machinist hammers with wooden handle

Młotki ślusarskie z rączką drewnianą..... 64

Machinist hammers with fibreglass handle

Młotki ślusarskie z rączką z włókna szklanego..... 64

Machinist hammers „Juco”

Młotki ślusarskie „Juco”..... 64

Brick hammers „Juco”

Młotki murarskie „Juco”..... 65

Welder's hammers „Juco”

Młotki spawalnicze „Juco”..... 65

Stoning hammers Młotki kamieniarskie



65

Stoning hammers „Juco”

Młotki kamieniarskie „Juco”..... 65

Hammers with tubular steel handle Młotki z trzonkiem rurowym



65-66

Claw hammers

Młotki szewskie..... 65

Roofing hammers

Młotki ciesielskie..... 65

Mason's hammers

Młotki murarskie..... 66

Hammers with fibreglass handle Młotki z rączką z włókna szklanego



66

Claw hammers

Młotki szewskie..... 66

Roofing hammers

Młotki ciesielskie..... 66

Rubber mallets Młotki gumowe



66-67

Rubber mallets with wooden handle

Młotki gumowe z rączką drewnianą..... 66

Rubber mallets with tubular steel handle

Młotki gumowe z rączką stalową..... 66

Rubber mallets with fibreglass handle

Młotki gumowe z rączką z włókna szklanego..... 66

Soft faced mallets

Młotki blacharskie gumowo-plastykowe..... 67

Wooden mallets Młotki drewniane



67

Chisels, cold chisels, punches & wrecking bars

Dłuta, przecinaki, przebijaki i łomy



67-69

Wood chisels with wooden handle

Dłuta stolarskie z rączką drewnianą..... 67

Wood chisels with plastic handle

Dłuta stolarskie z rączką z tworzywa..... 67

Curving chisels

Dłuta snycerskie..... 67

Cold chisels

Przecinaki..... 68

Cold chisels „Juco”

Przecinaki „Juco”..... 68

Punches

Przebijaki..... 68

Wrecking bars

Łomy..... 68

Wrecking bars „Juco”

Łomy „Juco”..... 69

Axes Siekiery



69-71

Axes with wooden handle

Siekiery z trzonkiem drewnianym..... 69

Axes with fibreglass handle

Siekiery z trzonkiem z włókna szklanego..... 70

Axes „Juco”

Siekiery „Juco”..... 70

Hammer and axe wedges

Zestawy klinujące do młotków i siekier..... 71

Picaxes Kilofy



71

Pickaxes

Kilofy..... 71

Wood splitters „Juco”

Kliny do rozłupywania drewna „Juco”..... 71

PL Młotek ślusarski
GB Machinist hammer
D Schlosserhammer
RUS Молоток слесарный

CZ Zámečnické kladívko
RO Ciocan de lăcătușerie
H Vaskalapács
E Martillo



No.	g	
30010	100	12/120
30020	200	12/72
30030	300	12/60
30040	400	6/48
30050	500	6/36
30060	600	6/36
30080	800	6/24
30100	1000	6/24
30150	1500	6/12
30200	2000	6/12

PL Młotek ślusarski
GB Machinist hammer
D Schlosserhammer
RUS Молоток слесарный

CZ Zámečnické kladívko
RO Ciocan de lăcătușerie
H Vaskalapács
E Martillo



No.	kg	
30531	3	1
30532	4	1
30533	5	1
30534	6	1
30535	8	1
30536	10	1

PL Młotek ślusarski
GB Machinist hammer
D Schlosserhammer
RUS Молоток слесарный

CZ Zámečnické kladívko
RO Ciocan de lăcătușerie
H Vaskalapács
E Martillo



JUCO

No.	g	
31010	100	10
31030	300	10
31050	500	10
31070	700	10
31100	1000	10
31150	1500	6
31200	2000	6

PL Młotek ślusarski
GB Machinist hammer
D Schlosserhammer
RUS Молоток слесарный

CZ Zámečnické kladívko
RO Ciocan de lăcătușerie
H Vaskalapács
E Martillo



VOREL

No.	g	
30410	100	6/120
30420	200	6/60
30430	300	6/60
30440	400	6/48
30450	500	6/36
30460	600	6/36
30480	800	6/24
30500	1000	6/24
30510	1500	6/12
30520	2000	6/12

PL Młotek ślusarski, rączka z włókna szklanego
GB Machinist hammer with fibreglass + PVC handle
D Schlosserhammer Fibreglasstiel
RUS Молоток со стеклопластиковой ручкой

CZ Zámečnické kladívko
RO Ciocan de lăcătușerie
H Vaskalapács
E Martillo



VOREL

No.	g	
30310	100	6/120
30320	200	6/36
30330	300	6/36
30340	400	6/36
30350	500	6/36
30360	600	6/36
30380	800	6/24
30390	1000	6/24
30395	1500	6/12
30400	2000	6/12

PL Młotek ślusarski
GB Machinist hammer
D Schlosserhammer
RUS Молоток слесарный

CZ Zámečnické kladívko
RO Ciocan de lăcătușerie
H Vaskalapács
E Martillo



JUCO

No.	g	
31300	3000	1
31400	4000	1
31500	5000	1
31600	6000	1
31800	8000	1
32000	10000	1

PL Młotek ślusarski
GB Machinist hammer
D Schlosserhammer
RUS Молоток слесарный

CZ Zámečnické kladívko
RO Ciocan de lăcătuşerie
H Vaskalapács
E Martillo

DIN 1041



JUCO

No.	g	
29992	300	5
29993	500	5
29994	700	5
29995	1000	5
29996	1500	5
29997	2000	5

PL Młotek spawalniczy
GB Welder's hammer
D Schweisserhammer
RUS Молоток сварщика

CZ Svářečské kladívko
RO Ciocan de sudură
H Hegesztő kalapács
E Martillo para soldar



JUCO

No.	g	
32110	350	5

PL Młotek szewski, rączka ze stali
GB Claw hammer with tubular steel handle
D Klauenhammer
RUS Молоток-гвоздодер с металлической обрезиненной рукояткой

CZ Ševcovské kladívko
RO Ciocan de cizmărie
H Cipész kalapács
E Martillo sacador mango de acero



VOREL

No.	g	
32625	600	6/24

PL Młotek murarski
GB Brick hammer
D Maurerhammer
RUS Молоток каменщика

CZ Zednické kladívko
RO Ciocan de zidărie
H Kőműves kalapács
E Martillo albañil



JUCO

No.	g	
32720	700	5

PL Młotek kamieniarski
GB Safety stoning hammer
D Fäustel
RUS Кувалда двухобуховая

CZ Palička kovová
RO Ciocan pt. zidarie
H Kőtörő kalapács
E Martillo

DIN 6475



JUCO

No.	g	
32201	1500	6
32202	2000	6
32203	3000	1
32204	4000	1
32205	5000	1
32206	6000	1
32207	8000	1
32208	10000	1

PL Młotek ciesielski, rączka ze stali
GB Roofing hammer with tubular steel handle
D Lattenhammer
RUS Молоток кровельщика

CZ Tesařské kladívko
RO Ciocan de dulgherie
H Ácskalapács
E Martillo sacador mango de acero



VOREL

No.	g	
32685	600	6/24

- PL Młotek murarski berliński, rączka ze stali
 GB Mason's hammer type „B” with tubular steel handle
 D Berliner Mauerhammer
 RUS Молоток каменщика
- CZ Zednické kladívko berlińské
 RO Ciocan de zidărie tip Berlin
 H Kőműves kalapács, berlini típus
 E Martillo berlin mango de acero



VOREL

No.	g	
32705	600	6/24

- PL Młotek szewski, rączka z włókna szklanego
 GB Claw hammer with fibreglass + PVC handle
 D Klauenhammer Fiberglasstiel
 RUS Молоток-гвоздодер со стеклопластиковой ручкой
 CZ Kladivo ševcovské, ručka ze skleněných vláken
 RO Cican pt. cismari, cu mânier din fibră de sticlă
 H Cipész kalapács
 E Martillo sacador con mango de fibra de vidrio



VOREL

No.	g	
32627	600	6/24

- PL Młotek gumowy
 GB Rubber mallet
 D Gummihammer
 RUS Киянка резиновая
- CZ Pryžové kladívko
 RO Ciocan de cauciuc
 H Gumikalapács
 E Mazo de goma



No.	mm	
33550	45	36/72
33650	55	12/60
33900	70	12/24

- PL Młotek gumowy, rączka z włókna szklanego
 GB Rubber mallet with fibreglass + PVC handle
 D Gummihammer Fiberglasstiel
 RUS Киянка резиновая с фиберглассовой ручкой
- CZ Pryžové kladívko
 RO Ciocan de cauciuc
 H Gumikalapács
 E Mazo de goma



- PL Młotek murarski reński, rączka ze stali
 GB Mason's hammer type „R” with tubular steel handle
 D Maurehammer rheinische Form
 RUS Молоток каменщика
- CZ Zednické kladívko reńské
 RO Ciocan de zidărie
 H Kőműves kalapács, rajnai típus
 E Martillo rin mango de acero



VOREL

No.	g	
32715	600	6/24

- PL Młotek ciesielski, rączka z włókna szklanego
 GB Roofing hammer with fibreglass + PVC handle
 D Lattenhammer Fiberglasstiel
 RUS Молоток кровельщика
 CZ Kladivo tesařské, ručka ze skleněných vláken
 RO Ciocan de dulgherie
 H Ácskalapács
 E Martillo de carpintero con mango de fibra de vidrio



VOREL

No.	g	
32687	600	6/24

- PL Młotek gumowy z rączką stalową
 GB Rubber mallet with steel handle
 D Gummihammer Stahlstiel
 RUS Киянка резиновая
- CZ Pryžové kladívko
 RO Ciocan de cauciuc
 H Gumikalapács
 E Mazo de goma



VOREL

No.	mm	
33557	50	6/60
33657	56	12/48
33907	66	6/24

- Placeholder icon for product 33535

VOREL

No.	mm	
33535	45	12/48
33555	50	6/48
33655	56	6/30
33905	66	6/24
33925	76	6/18

PL Młotek blacharski, guma - plastik
GB Soft faced mallet
D Ausbeulhammer
RUS Молоток рихтовочный комбинированный с деревянной ручкой

CZ Klempířské kladívko
RO Ciocan pt. tabla
H Bádogos kalapács
E Mazo goma-plastico

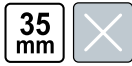

No.	mm	
33950	35	30/60

PL Młotek drewniany blacharski
GB Wooden mallet
D Holzhammer für Bleche
RUS Молоток жестящика, деревянный

CZ Palice dřevěná klempířská
RO Ciocan din lemn de tinichigiu
H Bádogos fakalapács
E Martillo de madera de hojalatero



No.	mm	
33532	285	20

PL Dłuto
GB Chisel
D Stechbeitel
RUS Стамеска с ударной головкой

CZ Řezbářské dláto
RO Dalță de tâmplărie
H Asztalos véső
E Cinceles con mango transparente



No.	mm	
25510	6	5/60
25511	8	5/60
25512	10	5/60
25513	12	5/60
25514	14	5/60
25515	15	5/60
25516	18	5/60
25517	20	5/60
25518	22	5/60
25519	25	5/60
25520	32	5/60
25521	38	5/60

PL Młotek drewniany stolarski
GB Carpenter's wooden mallet
D Tischlerhammer aus Holz
RUS Молоток деревянный столярный

CZ Palice dřevěná stolařská
RO Ciocan din lemn de tâmplar
H Asztalos fakalapács
E Martillo de madera de carpintero

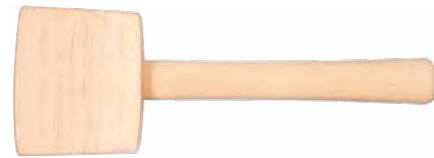

No.	mm	
33530	320	20

PL Zestaw dłut stolarskich
GB Wood chisel set
D Stech-Beitelsatz
RUS Набор стамесок

CZ Zámečnické dláta
RO Dalte de tâmplărie
H Asztalos véső
E Cinceles de carpintero



No.	pcs	
25500	4	10/40

PL Zestaw dłut do drewna
GB Wood chisel set
D Stechbeitelsatz
RUS Набор стамесок по дереву
CZ Zámečnické dláta
RO Set dalți
H Asztalos véső
E Juego de cinceles



No.	mm	pcs	
25530	6; 12; 18; 24	4	10/40

PL Zestaw dłut snycerskich
GB Curving chisel set
D Holzschnittwerkzeugsatz
RUS Набор фигурных стамесок для резьбы по дереву

CZ Řezbářské dláta
RO Dalte curbate cu mâner din lemn
H Finom véső
E Cinceles mango de madera



No.	pcs	
25700	6	15/60

PL Przecinak płaski z osłoną
GB Octagonal cold chisel with protection
D Flachmeissel mit Handschutz
RUS Зубило с протектором

CZ Plochý sekáč /z krytem/
RO Dalta zidarie cu protectie
H Hidegvágó, lapos /védőfejjel/
E Cincel plano /con protector/



No.	L (mm)	
35250	250	12/72
35300	300	12/48

PL Przecinak ślusarski
GB Forged cold chisel
D Flachmeissel
RUS Зубило слесарное

CZ Zámečnický sekáč
RO Dalta forjată pt. metal
H Lakatos hidegvágó
E Cincel de cerrajería



JUCO

No.	thickness / grubość (mm)	width / szerokość (mm)	L (mm)	weight / waga (kg)	
35372	10	20	200	0.25	10
35373	12	23	250	0.46	10
35374	12	23	300	0.53	10
35376	10	30	400	0.90	10

PL Przecinak murarski z osłoną
GB Forged cold chisel with protection
D Meissel mit Handschutz
RUS Зубило с протектором

CZ Zámečnický sekáč /z krytem/
RO Dalta forjată cu protectie
H Fém hidegvágó, kézvédővel
E Cincel de cerrajería mm con protector



JUCO

No.	thickness / grubość (mm)	L (mm)	weight / waga (kg)	
35359	17	250	0.56	5
35360	17	300	0.65	5
35362	17	350	0.76	5
35364	19	400	1.00	5
35366	19	450	1.13	5
35368	19	500	1.22	5

PL Łom płaski hartowany
GB Flat wrecking bar
D Nageleisen gehärtete Spitze
RUS Лом плоский закаленный

CZ Páčidlo ploché kalené
RO Ranga plata
H Lapos feszítővas
E Palanqueta



VOREL

No.	mm	
34251	450x6x35	6/24

PL Przecinak z osłoną
GB Cold chisel with protection
D Flachmeissel mit Handschutz
RUS Зубило с протектором

CZ Sekáč /z krytem/
RO Dalta cu protectie
H Hidegvágó /védőfejjel/
E Cincel /con protector/



VOREL

No.	mm	
35351	25x300	12/36
35352	25x350	10/30
35353	25x400	12/24
35355	25x500	5/20

PL Przebijak murarski z osłoną
GB Octagonal point chisel with protection
D Spitzmeissel mit Handschutz
RUS Керн с протектором

CZ Sekáč zednický s ochranným
RO Dorn cu protectie pt. constructii
H Falvész kézvédővel
E Cincel de cerrajería con protector

300 mm



No.	L (mm)	
35430	300	12/48

PL Łom
GB Wrecking bar
D Nageleisen
RUS Лом

CZ Páčidlo
RO Ranga
H Szögkihúzó
E Palanqueta



VOREL

No.	mm	
34243	500x18	10
34245	700x18	10
34247	1000x18	10

PL Łom kwadratowy, hartowane końcówki
GB Square type wrecking bar
D Nageleisen gehärtete Spitze
RUS Лом квадратный с закаленными концами

CZ Páčidlo hranaté, kalené konce
RO Ranga patrata
H Négyyszög keresztmetszetű feszítővas, edzett véggel
E Palanqueta



VOREL

No.	mm	
34254	400x22x12	12/24
34256	600x30x16	6/12

PL Łom CZ Pácidlo
 GB Wrecking bar RO Ranga pt. scos cuie
 D Nagelisen H Szögkihúzó
 RUS Лом-гвоздодёр E Palanqueta



No.	L (mm)	☐
34300	300	60

PL Łom sześciokątny CZ Šestiúhľé páčidlo
 GB Wrecking bar RO Ranga pt. scos cuie Profi
 D Brechstange H Hatszögű feszítővas
 RUS Лом-гвоздодёр шестигранный E Palanqueta



JUCO

No.	thickness / grubość (mm)	L (mm)	weight / waga (kg)	☐
34204	17	400	0.82	5
34205	17	500	1.10	5
34206	17	600	1.20	5
34207	17	700	1.40	5
34208	17	800	1.60	5
34210	19	1000	2.50	5
34212	19	1200	3.00	5

PL Siekiera ze stali kutej CZ Sekera ocelová kovaná
 GB Drop forged hatchet RO Toporisca lama forjata
 D Handbeil H Kovácsolt acél fejjsze
 RUS Топор кованый E Hacha de metalo forjado



FLO

No.	g	☐
33080	800	12/24

PL Siekiera CZ Sekyrka
 GB Axe RO Toporisca
 D Handbeil H Szekeerce
 RUS Топор с фиберглассовой ручкой E Hacha

FLO

No.	g	☐
33067	600	24
33087	800	20
33107	1000	12
33127	1250	12
33147	1400	12
33177	1600	12

PL Łom CZ Pácidlo
 GB Wrecking bar RO Ranga pt. scos cuie
 D Nagelisen H Szögkihúzó
 RUS Лом-гвоздодёр E Palanqueta



No.	L (mm)	☐
34600	600	24
34750	750	24
34900	900	24

PL Łom budowlany CZ Stavební páčidlo
 GB Wrecking bar RO Ranga Profi
 D Baubrechstange H Szögkihúzó
 RUS Лом круглый E Palanqueta de obra



JUCO

No.	diameter / średnica (mm)	L (mm)	weight / waga (kg)	☐
34220	27	1000	3.6	1
34222	27	1200	4.8	1
34225	27	1500	5.7	1

PL Siekiera CZ Sekyrka
 GB Axe RO Toporisca
 D Handbeil H Szekeerce
 RUS Топор E Hacha



FLO

No.	g	☐
32930	1000	10



PL Siekiera, rączka z włókna szklanego
 GB Axe with fibreglass + PVC handle
 D Handbeil Fiberglasstiel
 RUS Топор с фиберглассовой ручкой

CZ Sekyrka
 RO Toporisca cu coada din fibra de sticla
 H Szekerce
 E Hacha con mango de fibra de vidrio



VOREL

No.	g	
33065	600	20
33085	800	20
33105	1000	12
33125	1250	6

PL Siekiera
 GB Axe
 D Handbeil
 RUS Топор

CZ Sekyrka
 RO Toporisca
 H Szekerce
 E Hacha



JUKO

No.	g	DIN	
33000	400	5131	5
33001	600	5131	5
33002	800	5131	5
33003	1000	5131	5
33004	1250	7294	5
33005	1500	7294	5
33006	1800	7294	5
33007	2000	7294	5
33008	2500	7294	5

PL Siekiera z klinem
 GB Axe
 D Handbeil
 RUS Топор-колуш

CZ Sekyrka
 RO Toporisca
 H Szekerce
 E Hacha

JUKO

No.	kg	
32924	2	5

PL Siekiero-mlot
 GB Hammer-axe for wood splitting
 D Spaltaxt
 RUS Топор-колуш

CZ Sekera-kladivo
 RO Secure-ciocan
 H Szekerce-kalapács
 E Hacha martillo para partir madera



JUKO

No.	kg	
32927	2.1	1
32928	3.2	1

PL Siekiera
 GB Axe
 D Handbeil
 RUS Топор

CZ Sekyrka
 RO Toporisca
 H Szekerce
 E Hacha



JUKO

No.	g	DIN	
33024	400	5131	5
33026	600	5131	5
33028	800	5131	5
33030	1000	5131	5
33032	1250	7294	5
33035	1500	7294	5
33038	1800	7294	5
33039	2000	7294	5
33040	2500	7294	5

PL Zestaw siekier tradycyjnych
 GB Axe set
 D Satz traditioneller Äxte
 RUS Набор традиционных топоров

CZ Sada klasických seker
 RO Set topoare
 H Hagyományos balta készlet
 E Set de hechas tradicionales



JUKO

No.	kg	
32999	0.4; 1.5	5



PL Siekiero-mlot
 GB Hammer-axe for wood splitting
 D Spaltaxt
 RUS Топор-колуш

CZ Sekera-kladivo
 RO Secure-ciocan
 H Szekerce-kalapács
 E Hacha martillo para partir madera



JUKO

No.	kg	
32925	2.5	1
32926	4.0	1

PL Siekiera kanadyjska
GB Canadian axe
D Handbeil „Kanadische Form“
RUS Топор канадского типа

CZ Sekera kanadská
RO Topor canadian
H Hosszú nyelvű, hasító fejsze
E Hacha canada

1.8 kg



JUCO

No.	kg	
33022	1.8	5

PL Zestaw klinujący
GB Hammer wedges
D Keilesatz
RUS Набор клинов

CZ Sada klínků
RO Set cultivator
H Ékelő készlet
E Juego de sujeción



JUCO

No.	for hammer / do młotka (kg)	for axe / do siekiery (kg)	
99460	0.1-0.5	-	50
99461	0.7-2.0	-	50
99462	3.0-4.0	0.4	50

PL Kilof bez trzonka
GB Pick axe
D Spitzhacke ohne Stiel
RUS Кирка двухсторонняя без черенка

CZ Násada na krumpáč
RO Coada tarnacop
H Csákánynyél
E Palo para pico

2.5 kg



VOREL

No.	kg	
32901	2.5	8

PL Kilof oprawiony
GB Pick axe
D Spitzhacke
RUS Кирка двухсторонняя с черенком

CZ Krumpáč osazený
RO Târâncop cu coadă
H Ékelt csákány
E Piqueta

2.5 kg



VOREL

No.	kg	
32900	2.5	6

PL Zestaw klinujący
GB Hammer wedges
D Keilesatz
RUS Набор клинов

CZ Sada klínků
RO Set cultivator
H Ékelő készlet
E Juego de sujeción

10 PCS

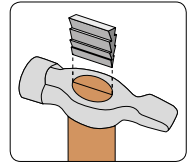
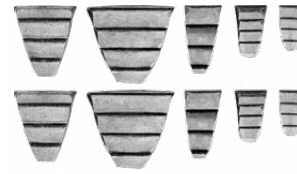

VOREL

No.	pcs	
99472	10	6/72

PL Zestaw klinujący
GB Hammer wedges
D Keilesatz
RUS Набор клинов

CZ Sada klínků
RO Set cultivator
H Ékelő készlet
E Juego de sujeción



JUCO

No.	for hammer / do młotka (kg)	for axe / do siekiery (kg)	
99463	5-6	0.6-1.0	50
99464	8-10	1.2-2.5	50

PL Trzonek do kilofa
GB Wooden handle for pick axe
D Stiel für Spitzhacke
RUS Черенок для кирки

CZ Násada na krumpáč
RO Coada tarnacop
H Csákánynyél
E Palo para pico

90 cm



No.	L (cm)	for / dla	
32902	90	32901	10

PL Klin do rozłupywania drewna
GB Wood splitter
D Spaltkeil
RUS Клин для раскалывания бревен

CZ Klin na štípání polen
RO Pana pt. lemn
H Fahasító ék
E Cuña para partir madera



JUCO

No.	kg	
32922	2	1
32923	3	1

7

Clamps & vices Ściski i imadła

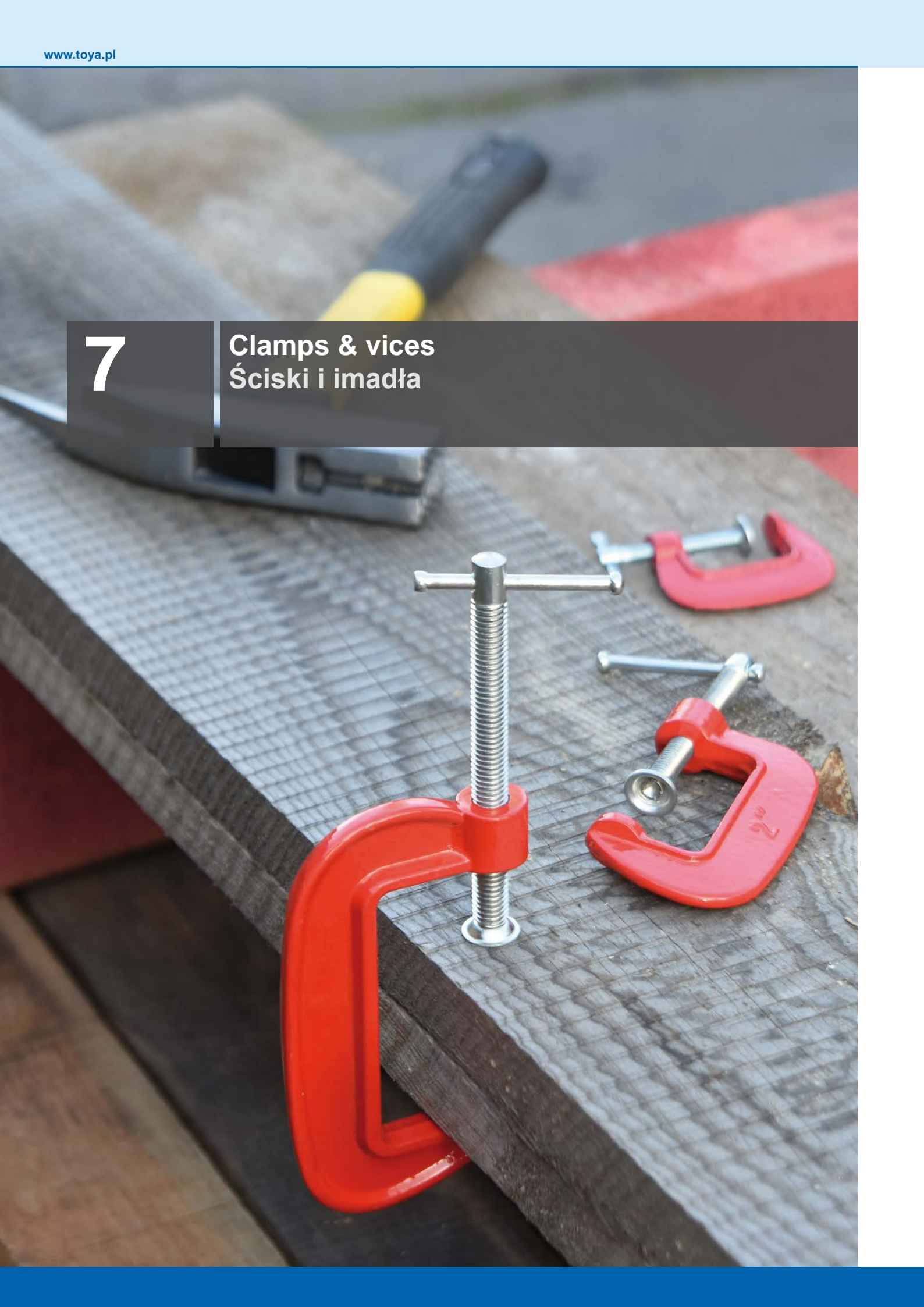

Clamps Ściski



74-76

F-clamps & sets

Ściski stolarskie i zestawy..... 74

Quick release clamps

Ściski szybkozaciskowe..... 74

Battenboard clamps

Ściski do klejenia płyt stolarskich..... 75

Spring clamps

Ściski sprężynowe..... 75

Corner clamps

Ściski kątowe..... 75

Frame clamps

Ściski taśmowe..... 75

C-clamps

Ściski typu „C”..... 76

Ratchet floor clamps

Pasy ściągające do paneli podłogowych..... 76

Vices Imadła



76-77

Baby vices

Imadła stołowe..... 76

Bench vices

Imadła ślusarskie..... 77

Hinged pipe vices

Imadła zaciskowe do rur..... 77

PL Ścisk stolarski CZ Truhlářské upínadlo
 GB F-clamp RO Presa lemn
 D Schraubzwinge H Asztalos szorító
 RUS Струбцина E Tornillo de apriete



PL Ścisk stolarski CZ Truhlářské upínadlo
 GB F-clamp RO Presa lemn
 D Schraubzwinge H Asztalos szorító
 RUS Струбцина E Tornillo de apriete



7



No.	mm	
37100	50x100	12/60
37101	50x150	12/60
37102	50x200	12/60
37103	50x250	12/60
37104	50x300	12/60
37106	80x200	10/30
37107	80x250	10/30
37108	80x300	10/20
37109	80x500	10/20
37110	120x300	10/20
37111	120x500	10
37112	120x800	10
37113	120x1000	6
37114	120x1200	6
37115	120x1500	6

No.	mm	
37150	50x150	12/60
37200	50x200	12/60
37250	50x250	12/60
37300	50x300	12/60
37380	80x300	15/30
37400	80x500	15/30
37430	120x300	10/20
37500	120x500	10/20
37800	120x800	10
37900	120x1000	10

PL Ścisk stolarski CZ Truhlářské upínadlo
 GB F-clamp RO Presa lemn tip „F”
 D Schraubzwinge H Asztalos szorító
 RUS Струбцина E Tornillo de apriete



PL Ścisk szybkowzajacowy CZ Svěrka rychloupínací
 GB Quick release clamp RO Clemă cu prindere rapidă
 D Schnellklemme H Gyors asztalos szorító
 RUS Быстрозажимная струбцина E Apretador rápido



No.	mm	max. expand range / max. zasięg rozpięcia (mm)	max. clamping range / max. zasięg ściskania (mm)	max. jaws depth / max. głębokość szczęk (mm)	
38401	150	141-312	0-152	63	12/36
38402	200	141-355	0-203	63	6/36
38403	250	141-405	0-254	63	6/30
38404	300	141-464	0-304	63	6/30
38406	350	141-555	0-355	63	6/24
38407	450	141-617	0-457	63	6/24
38408	600	141-769	0-609	63	6/18
38409	750	141-922	0-762	63	6/12

No.	mm	
38150	50x150	2 10/30
38200	50x200	2 10/30

- PL Ścisnik z prowadnicą aluminiową do klejenia płyt
 GB Squeezing clamp
 D Aluminium-Fugzwinge
 RUS Струбцина-вайма
 CZ Dverový upínač
 RO Menghina pt. tamplarie
 H Táblásító szorító
 E Prensa sargento de aluminio



No.	L (mm)	
38642	900	10
38641	1500	10
38643	2400	10

- PL Ścisnik sprężynowy
 GB Spring clamp
 D Federklemme
 RUS Струбцина пружинная
- CZ Pružinové upínadlo
 RO Cleste presa pt. lemni
 H Rugós szorító
 E Pinza



No.	mm	
38500	100	24/240
38515	150	12/120
38525	200	10/100

- PL Ścisnik stolarski kątowy
 GB Corner clamp
 D Gehrungszwinge
 RUS Струбцина угловая
- CZ Truhlářské upínadlo úhlové
 RO Cleste presa colt
 H Asztalos szorító, sarok
 E Tornillo de angulo

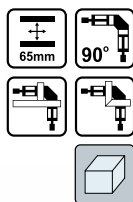

No.	mm	
38751	65	6/12

- PL Ścisnik do klejenia płyt mocowanie na rurę
 GB Pipe clamps
 D Holz kleben Rohrschelle
 RUS Струбцина трубная
- CZ Trubková zvierka
 RO Menghina tamplarie pt. tevi
 H Végtelen csavaros fém szorító
 E Prensa sargento para carpintería

3/4"
19mm



No.	
38620	12

- PL Ścisnik stolarski kątowy
 GB Corner clamp
 D Gehrungszwinge
 RUS Струбцина угловая
- CZ Truhlářské upínadlo úhlové
 RO Cleste presa colt
 H Asztalos szorító, sarok
 E Tornillo de angulo

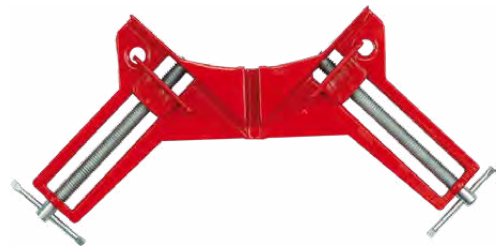
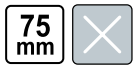

No.	mm	
38750	75	10/100

- PL Ścisnik taśmowy
 GB Frame clamp
 D Bandzwinge
 RUS Ленточный зажим
- CZ Pásová svorka
 RO Clema pt. cadru
 H Szalagos szorító
 E Tensor de cinta



No.	m	
38531	4	20

PL Ścisk typu „C”
GB C clamp
D C-Schraubzwinge
RUS Струбцина тип „G”

CZ Sverka tvaru „C”
RO Menghina tip „C”
H Pillanatszorító
E Tornillo tipo „C”



No.	size / rozmiar (mm)	force pressure / sila nacisku (kg)	
38430	50	140	50
38431	75	190	50
38432	100	270	30
38433	125	320	20
38434	150	360	18
38435	200	390	10
38436	250	420	6

PL Pas ściągający do paneli podłogowych
GB Ratchet floor clamp
D Spangurt für Laminatpannele /mit Hacken und Knarre/
RUS Ремень для стяжки напольных панелей
CZ Stahovací pás na podlažní panele
RO Curea elastică strâns plăci parchet
H Padlópanelhez rögzítő pánt
E Cinta tirante para placas de suelo



No.	tape / taśma L (m)	
82355	5	10/20

PL Imadlo stolowe
GB Baby vice - swivel base
D Bankschraubstock drehbar
RUS Тиски настольные поворотные

CZ Stolní svěrák otáčivý
RO Menghină rotativă de masă
H Satu, asztali, forgó
E Tornillo de apriete giratorio



No.	mm	
36014	40	12/24
36015	50	10/20
36016	60	9/18
36018	75	6/12

PL Ściski modelarskie
GB C-clamp set
D Mini-Schraubwingensatz
RUS Набор струбцин G-типа

CZ Modelářské upínadlo
RO Presa lemă tip „C” set
H Modellező szorítók
E Tornillos tipo „C”



No.	mm	
38830	25; 50; 75	12/48

PL Imadlo stolowe
GB Baby vice - fixed base
D Bankschraubstock
RUS Тиски настольные неповоротные

CZ Stolní svěrák
RO Menghină de masă
H Satu, asztali
E Tornillo de apriete



No.	mm	
36000	25	15/60
36004	40	12/48
36005	50	18/36
36006	60	12/24
36008	70	10/20

PL Imadlo stolowe
GB Baby vice - fixed base
D Bankschraubstock
RUS Тиски настольные поворотные

CZ Stolní svěrák
RO Menghină de masă
H Satu, asztali
E Tornillo de apriete



No.	mm	
36650	65	10

PL Imadlo ślusarskie
GB Bench vice - fixed base
D Schlosserschraubstock
RUS Тиски слесарные с наковальней

CZ Zámečnický svěrák
RO Menghină de lăcătuşerie
H Satu, lakatos
E Tornillo de apriete



No.	mm	
36032	100	1
36033	125	1
36034	150	1

PL Imadlo zaciskowe do rur
GB Hinged pipe vice
D Rohrschraubstock
RUS Тиски для труб

CZ Upínací svěrák na trubky
RO Menghină pt. țevi
H Satu, csőszorító
E Tornillo de apriete para tubos



No.	mm	
36570	13-50	6

PL Imadlo ślusarskie obrotowe
GB Bench vice - swivel base
D Schlosserschraubstock drehbar
RUS Тиски слесарные поворотные

CZ Zámečnický svěrák otáčivě
RO Menghină de lăcătuşerie rotativă
H Satu, lakatos forgó
E Tornillo de apriete giratorio



No.	mm	
36037	100	1
36038	125	1
36039	150	1

7



Memo

8

Cutting tools Narzędzia tnące



Drill bits Wiertła

81-90



Twist drill bits HSS & sets

Wiertła do metalu HSS i zestawy..... 81

Twist drill bits HSS-G & sets

Wiertła do metalu HSS-G i zestawy..... 82

Step drills & sets

Wiertła stopniowe i zestawy..... 82

Universal drills & sets

Wiertła uniwersalne i zestawy..... 83

Masonry drill bits & sets

Wiertła do betonu i zestawy..... 84

Wood drill bits

Wiertła do drewna..... 84

SDS Masonry drill bits & sets

Wiertła do betonu SDS i zestawy..... 85

SDS Chisels

Przecinaki i dłuta SDS..... 86

Hollow drill sets

Wiertła koronowe do betonu..... 88

Hole saw kits

Zestawy otwornic..... 88

Tungsten carbide hole saws

Otwornice z węglikiem wolframu..... 89

Drills for glass, ceramic tiles & sets

Wiertła do szkła, ceramiki, gresu i zestawy..... 89

Taps & dies

Narzędzia do gwintowania

90-92



Hand taps CZ TOOLS

Gwintowniki CZ TOOLS..... 90

Circular dies CZ TOOLS

Narzynki CZ TOOLS..... 90

Machine taps CZ TOOLS

Gwintowniki maszynowe CZ TOOLS..... 90

Tap & die sets CZ TOOLS

Zestawy gwintowników i narzynek CZ TOOLS..... 90

Tap wrenches & die holders

Pokrętła do gwintowników i narzynek..... 91

Tap & die sets

Zestawy gwintowników i narzynek..... 91

Screw extractor sets

Wykrętaki do zerwanych śrub..... 92

Router bits, rotary rasps & sets

Frezy do drewna, metalu i zestawy

92



Diamond tools

Narzędzia diamentowe

92-93



Diamond blades for cutting construction materials

Tarcze diamentowe do cięcia materiałów budowlanych..... 92

Diamond rod saws

Brzeszczoły diamentowe..... 93

Tungsten carbide tipped tools

Narzędzia z ostrzem z węglika wolframu

93-94



Tungsten carbide saws for wood

Tarcze z węglikiem do drewna..... 93

Tungsten carbide saws for aluminium

Tarcze z węglikiem do aluminium..... 94

Cutting & grinding discs

Tarcze do cięcia i szlifowania

94-95



Metal cutting discs

Tarcze do cięcia metalu..... 94

Metal grinding discs

Tarcze do szlifowania metalu..... 95

Stone cutting discs

Tarcze do cięcia kamienia..... 95

Stone grinding discs

Tarcze do szlifowania kamienia..... 95

Flap discs

Ściernice listkowe talerzowe

95



Chain discs

Tarcze łańcuchowe

96



Grinding discs

Tarcze do szlifierek stołowych

96



Shears

Nożyce

96-98



Tin snips

Nożyce do blachy..... 96

Bolt cutters

Nożyce do prętów..... 98

Saws & blades

Piły i brzeszczoły

98-104



Hand saws

Piły do drewna..... 98

Bow saws

Piły kabłąkowe..... 99

Bow saw blades

Brzeszczoły do pił kabłąkowych..... 99

Compass saws

Piły otwornice..... 99

Saws for gas concrete

Piły do gazobetonu..... 99

Hacksaw frames

Piły do metalu..... 100

Cross cut saws

Piły poprzeczne..... 101

Miter saws Piły kątowe.....	101
Miter boxes Skrzynki uciosowe.....	101
Blades Brzeszczoty.....	102
Jig saw blades Brzeszczoty do wyrzynarek.....	103
Brushes, knives & files Szczotki, noże i pilniki	104-116
Wire brushes Szczotki druciane.....	104
Cup brushes Szczotki tarczowe.....	104
Rubber discs Tarcze gumowe do elektronarzędzi.....	106
Pocket knives Noże składane.....	108
Window scrapers Skrobaki do szyb.....	111
Glass cutters Nożyki do cięcia szkła.....	111
Marking out tools Narzędzia traserskie.....	111
Scrapers Cykliny.....	111
Wood carving knife sets Zestawy nożyków precyzyjnych.....	111
Scissors Nożyczki.....	111
Leatherwork accessories Akcesoria kaletnicze.....	112
Wood planes Strugi.....	112
Steel files Pilniki do metalu.....	113
Diamond whetstones & sets Oselki diamentowe i zestawy.....	114
Rasps Tarniki do drewna.....	114
Rasps for plaster Tarniki do gipsu.....	115



Abrasive products Artykuły ściernie

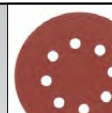

.....	116-119
Sharpening stones Oselki.....	116
Waterproof sand papers Papiery ściernie wodoodporne.....	116
Abrasive clothes Piłna ściernie.....	117
Abrasive meshes Siatki ściernie.....	117
No end abrasive bands Taśmy ściernie bezkońcowe.....	117
Abrasive sponges Kostki ściernie.....	117
Abrasive sheets and discs Arkusze i krążki ściernie.....	118
Sanding blocks Błoki ściernie.....	118
Polishing sets Zestawy polerskie.....	119

PL Wiertło do metalu CZ Vrták na kov
 GB Twist drill bit RO Burghiu pt. metal
 D Spiralbohrer H Fúrószár fémhez
 RUS Сверло по металлу E Broca para metalo



No.	Ø (mm)	pcs	Box
20100	1.0	10	200/10000
20150	1.5	10	200/8000
20200	2.0	10	200/8000
20250	2.5	10	200/4000
20280	2.8	10	200/4000
20300	3.0	10	200/4000
20320	3.2	10	200/4000
20350	3.5	10	100/4000
20400	4.0	10	100/4000
20420	4.2	10	100/2500
20450	4.5	10	100/2500
20500	5.0	10	100/2500
20550	5.5	10	100/2000
20600	6.0	10	50/1200
20650	6.5	10	50/1200
20700	7.0	10	50/1200
20800	8.0	5	50/600
20850	8.5	5	50/600
20900	9.0	5	50/600
21000	10.0	5	50/250
21100	11.0	5	50/250
21200	12.0	5	50/250
21250	12.5	5	50/250
21300	13.0	5	50/250
21400	14.0	5	50/200
21600	16.0	5	10/100

PL Komplet wiertel do metalu
 GB Twist drill set
 D Spiralbohrersatz
 RUS Набор сверл по металлу
 CZ Vrtáky na kov
 RO Burghie pt. metal
 H Fúrószár fémhez
 E Broca para metalo



No.	Ø (mm)	pcs	Box
22330	1.0; 1.5; 2.0; 2.5; 3.0; 3.5; 4.0; 4.5; 5.0; 5.5; 6.0; 6.5; 7.0; 7.5; 8.0; 8.5; 9.0; 9.5; 10.0	19	30
22340	1.0; 1.5; 2.0; 2.5; 3.0; 3.5; 4.0; 4.5; 5.0; 5.5; 6.0; 6.5; 7.0; 7.5; 8.0; 8.5; 9.0; 9.5; 10.0; 10.5; 11.0; 11.5; 12.0; 12.5; 13.0	25	20

PL Komplet wiertel do metalu
 GB Twist drill set
 D Spiralbohrersatz
 RUS Набор сверл по металлу
 CZ Vrtáky na kov
 RO Burghie pt. metal
 H Fúrószár fémhez
 E Broca para metalo



No.	Ø (mm)	pcs	Box
22130	1.5; 2.0; 2.5; 3.0; 3.2; 3.5; 4.0; 4.5; 4.8; 5.0; 5.5; 6.0; 6.5	13	25/100
22180	2.0; 2.5; 3.0; 3.5; 4.0; 4.5; 5.0; 5.5; 6.0; 6.5; 7.0; 7.5; 8.0	13	25/50

PL Komplet wiertel do metalu
 GB Twist drill set
 D Spiralbohrersatz
 RUS Набор сверл по металлу
 CZ Vrtáky na kov
 RO Burghie pt. metal
 H Fúrószár fémhez
 E Broca para metalo



No.	Ø (mm)	pcs	Box
22190	1.0; 1.5; 2.0; 2.5; 3.0; 3.5; 4.0; 4.5; 5.0; 5.5; 6.0; 6.5; 7.0; 7.5; 8.0; 8.5; 9.0; 9.5; 10.0	19	30
22250	1.0; 1.5; 2.0; 2.5; 3.0; 3.5; 4.0; 4.5; 5.0; 5.5; 6.0; 6.5; 7.0; 7.5; 8.0; 8.5; 9.0; 9.5; 10.0; 10.5; 11.0; 11.5; 12.0; 12.5; 13.0	25	20

PL Komplet wiertel do metalu
 GB Twist drill set
 D Spiralbohrersatz
 RUS Набор сверл по металлу
 CZ Vrtáky na kov
 RO Burghie pt. metal
 H Fúrószár fémhez
 E Broca para metalo



No.	Ø (mm)	pcs	Box
22300	1.5; 2.0; 2.5; 3.0; 3.2; 3.5; 4.0; 4.5; 4.8; 5.0; 5.5; 6.0; 6.5	13	25/100
22310	2.0; 2.5; 3.0; 3.5; 4.0; 4.5; 5.0; 5.5; 6.0; 6.5; 7.0; 7.5; 8.0	13	25/50

PL Wiertło do metalu HSS CZ Vrták na kov HSS
 GB HSS twist drill bit RO Burghiu pt. metal HSS
 D Spiralbohrer HSS H Fúrószár fémhez HSS
 RUS Свёрло по металлу HSS E Broca para metalu HSS



PL Komplet wiertel do metalu
 GB Twist drill set
 D Spiralbohrersatz
 RUS Набор свёрл по металлу
 CZ Vrtáky na kov
 RO Burghie pt. metal
 H Fúrószár fémhez
 E Broca para metalu

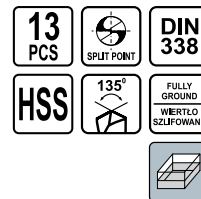

STHOR

No.	Ø (mm)	pcs	Box
21998	2.0; 2.5; 3.0; 3.5; 4.0; 4.5; 5.0; 5.5; 6.0; 6.5; 7.0; 7.5; 8.0	13	10/50

PL Komplet wiertel do metalu
 GB Twist drill set
 D Spiralbohrersatz
 RUS Набор свёрл по металлу
 CZ Vrtáky na kov
 RO Burghie pt. metal
 H Fúrószár fémhez
 E Broca para metalu

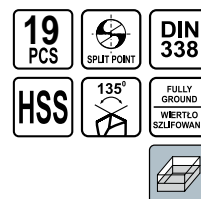

STHOR

No.	Ø (mm)	pcs	Box
21999	1.0; 1.5; 2.0; 2.5; 3.0; 3.5; 4.0; 4.5; 5.0; 5.5; 6.0; 6.5; 7.0; 7.5; 8.0; 8.5; 9.0; 9.5; 10.0	19	5/30

PL Komplet wiertel do metalu
 GB Twist drill set
 D Spiralbohrersatz
 RUS Набор свёрл по металлу
 CZ Vrtáky na kov
 RO Burghie pt. metal
 H Fúrószár fémhez
 E Broca para metalu

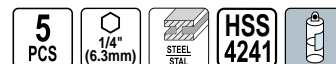

STHOR

No.	Ø (mm)	pcs	Box
21650	4, 5, 6, 8, 10	5	30/60

PL Wiertło stopniowe
 GB Step drill
 D Stufenbohrer
 RUS Свёрло ступенчатое
 CZ Stupňovitý vrták
 RO Burghiu din titan cu gaurire in trepte
 H Lépcsős fúró
 E Broca cónica escalonada

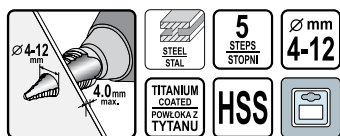

STHOR

No.	Ø (mm)	Box
22610	4; 6; 8; 10; 12	25/200

PL Wiertło stopniowe
 GB Step drill
 D Stufenbohrer
 RUS Свёрло ступенчатое
 CZ Stupňovitý vrták
 RO Burghiu din titan cu gaurire in trepte
 H Lépcsős fúró
 E Broca cónica escalonada

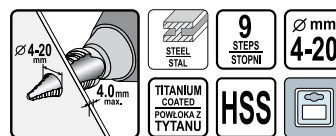

STHOR

No.	Ø (mm)	Box
22611	4; 6; 8; 10; 12; 14; 16; 18; 20	25/100

PL Wiertło stopniowe
 GB Step drill
 D Stufenbohrer
 RUS Сверло ступенчатое
 CZ Stupňovitý vrták
 RO Burghiu din titan cu gaurire in trepte
 H Lépcsős fúró
 E Broca cónica escalonada

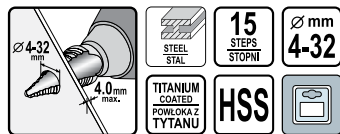

STHOR

No.	Ø (mm)	Box
22612	4: 6: 8: 10: 12: 14: 16: 18: 20: 22: 24: 26: 28: 30: 32	80

PL Zestaw wiertel stopniowych
 GB Step drills
 D Stufenbohrer set
 RUS Набор сверл по бетону
 CZ Stupňovité vrtáky sada
 RO Set burghie in trepte
 H Lépcsős fúró készlet
 E Brocas cónicas escalonadas



STHOR

No.	Ø (mm)	Box
22616	4-12: 4-20: 4-32	20

PL Komplet wiertel uniwersalnych
 GB Masonry drill set
 D Betonbohrer
 RUS Набор сверл по бетону
 CZ Souprava vrtáků do betonu
 RO Set de burghie pt. beton
 H Fúrószárkészlet betonhoz
 E Brocas para hormigon



STHOR

No.	Ø (mm)	pcs	Box
21695	4: 5: 6: 8: 10	5	25/100

PL Wiertło uniwersalne
 GB Universal drill
 D Universalbohrer
 RUS Универсальное сверло с шестигранным хвостовиком

CZ Víceúčelový vrták
 RO Burghiu universal cu coada hexagonala
 H Közét és többcélú fúró
 E Broca multimatierial

STHOR

No.	Ø (mm)	L (mm)	Box
21680	3	75	150/600
21682	4	80	150/600
21684	5	85	100/400
21686	6	110	100/400
21688	7	110	100/400
21690	8	120	100/400
21691	10	120	50/200
21692	12	150	50/200

PL Wiertło stopniowe
 GB Step drill
 D Stufenbohrer
 RUS Сверло ступенчатое
 CZ Stupňovitý vrták
 RO Burghiu din titan cu gaurire in trepte
 H Lépcsős fúró
 E Broca cónica escalonada

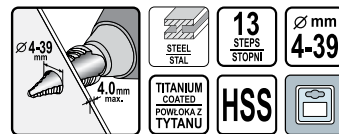

STHOR

No.	Ø (mm)	Box
22613	4: 6: 9: 12: 15: 18: 21: 24: 27: 30: 33: 36: 39	40

PL Zestaw wiertel stopniowych
 GB Step drills
 D Stufenbohrer set
 RUS Набор сверл по бетону
 CZ Stupňovité vrtáky sada
 RO Set burghie in trepte
 H Lépcsős fúró készlet
 E Brocas cónicas escalonadas



STHOR

No.	Ø (mm)	Box
22617	4-12: 4-20: 4-32: 4-39	20

PL Komplet wiertel uniwersalnych
 GB Masonry drill set
 D Betonbohrer
 RUS Набор сверл по бетону
 CZ Souprava vrtáků do betonu
 RO Set de burghie pt. beton
 H Fúrószárkészlet betonhoz
 E Brocas para hormigon

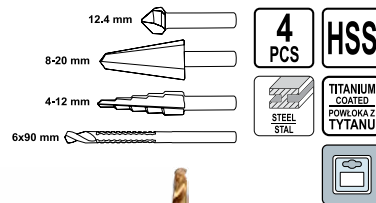

STHOR

No.	pcs	Box
22640	4	25/100



PL Wiertła do betonu
 GB Masonry drill set
 D Betonbohrer
 RUS Набор сверл по бетону
 CZ Souprava vrtáků do betonu
 RO Set de burghie pt. beton
 H Fúrószárkészlet betonhoz
 E Brocas para hormigon



STHOR

No.	mm	pcs	Icon
23331	4; 5; 6; 8; 10	5	50/200

PL Wiertła do drewna
 GB Wood drill set
 D Holzbohrersatz
 RUS Набор сверел по дереву

CZ Vrtáky na dřevo
 RO Burghie pt. lemn
 H Fúró fához
 E Brocas para maderaz



No.	Ø (mm)	pcs	Icon
22350	4; 5; 6; 8; 10	5	25/200

PL Wiertła do drewna
 GB Wood drill set
 D Holzbohrersatz
 RUS Набор сверел по дереву
 CZ Vrtáky na dřevo
 RO Burghie pt. lemn
 H Fúró fához
 E Brocas para maderaz



STHOR

No.	Ø (mm)	pcs	Icon
22381	3; 4; 5; 6; 7; 8; 9; 10	8	10/80

PL Wiertło do betonu
 GB Masonry drill bit
 D Betonbohrer
 RUS Сверло по бетону

CZ Vrták na beton
 RO Burghiu pt. beton
 H Fúrószár betonhoz
 E Broca para hormigon



STHOR

No.	Ø (mm)	L (mm)	Icon
23311	4	75	200/1600
23312	5	85	200/1600
23313	6	100	200/1000
23324	6	400	100/300
23314	7	100	200/1000
23315	8	120	100/500
23325	8	400	50/200
23316	10	120	100/500
23326	10	400	50/100
23317	12	150	50/200
23327	12	400	50/100
23318	14	150	50/150
23328	14	400	50/100
23319	16	150	50/150
23329	16	400	50/100
23320	18	150	50/150
23321	20	150	25/100

PL Wiertła do drewna
 GB Wood drill set
 D Holzbohrersatz
 RUS Набор сверел по дереву

CZ Vrtáky na dřevo
 RO Burghie pt. lemn
 H Fúró fához
 E Brocas para maderaz



STHOR

No.	Ø (mm)	pcs	Icon
22380	3; 4; 5; 6; 7; 8; 9; 10	8	20/100

PL Wiertła do drewna
 GB Wood drill set
 D Holzbohrersatz
 RUS Набор сверел по дереву

CZ Vrtáky na dřevo
 RO Burghie pt. lemn
 H Fúró fához
 E Brocas para maderaz



STHOR

No.	Ø (mm)	L (mm)	pcs	Icon
22460	6; 8; 10; 12; 13; 14	300	6	25

PL Wiertła do drewna CZ Vrtáky na dřevo
 GB Wood drill set RO Burghie pt. lemn
 D Holzbohrersatz H Fűrő fához
 RUS Набор сверл по дереву E Brocas para madera

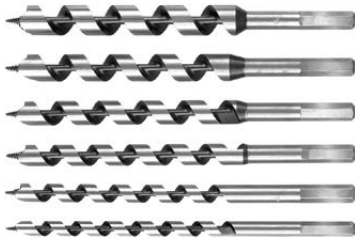

No.	Ø (mm)	L (mm)	pcs	Icon
22465	10; 12; 14; 16; 18; 20	230	6	10

PL Wiertła do drewna, łopatkowe CZ Vrtáky na dřevo
 GB Flat wood bits RO Burghie pt. lemn
 D Holz-Flachfräsbohrersatz H Fűrő fához
 RUS Набор сверл по дереву E Brocas para madera



No.	Ø (mm)	pcs	Icon
22500	10; 12; 16; 18; 20; 25	6	10/100

PL Zestaw świderków ręcznych CZ Nebozez kovový
 GB Hand gimlet set RO Burghiu de palma
 D Handbohrer H Kézí fűrő
 RUS Бурав по дереву E Broca manual



No.	Ø (mm)	pcs	Icon
22430	1.5; 2.0; 3.0	3	15/360

PL Zestaw świderków ręcznych CZ Nebozez kovový
 GB Hand gimlet set RO Burghiu de palma
 D Handbohrer H Kézí fűrő
 RUS Бурав по дереву E Broca manual



No.	Ø (mm)	pcs	Icon
22431	2; 3; 4; 5	4	20/200

PL Wiertła do drewna CZ Vrtáky na dřevo
 GB Wood drill set RO Burghie pt. lemn
 D Holzbohrersatz H Fűrő fához
 RUS Набор сверл по дереву E Brocas para madera

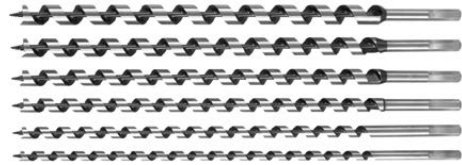

No.	Ø (mm)	L (mm)	pcs	Icon
22466	10; 12; 14; 16; 18; 20	460	6	10

PL Wiertło do betonu CZ Vrták na beton
 GB Masonry drill bit RO Burghiu pt. beton
 D Betonbohrer H Fűrőszár betonhoz
 RUS Бур по бетону E Broca para hormigon



No.	Ø (mm)	L (mm)	Icon
23620	5	110	10/500
23640	6	110	10/500
23650	6	160	10/500
23660	6	210	10/300
23670	8	110	10/500
23680	8	160	10/400
23690	8	210	10/250
23692	8	300	10/200
23693	8	460	10/100
23694	8	600	10/100
23710	10	160	10/300
23720	10	210	10/250
23722	10	300	10/150
23723	10	460	10/100
23724	10	600	10/100
23730	12	160	10/300
23740	12	460	10/100
23750	12	266	10/150
23752	12	600	10/60
23800	14	166	10/200
23820	14	460	10/80
23830	14	266	10/150
23832	14	600	10/50
23840	16	200	10/160
23850	16	300	8/96
23860	16	460	8/48
23862	16	600	8/48
23880	18	300	8/72
23882	18	460	6/48
23883	18	600	6/48
23920	20	300	5/50
23930	20	460	5/50
23932	20	600	5/30
23960	22	460	5/25
23962	22	600	5/25
23980	25	300	5/50
23982	25	600	5/15
23990	25	460	5/25
23992	28	600	2/10
23999	30	600	2/10

PL Wiertło do betonu CZ Vrták na betonu
 GB Masonry drill bit RO Burghiu pt. beton
 D Betonbohrer H Fúrószár betonhoz
 RUS Бур по бетону E Broca para hormigon



STHOR

No.	Ø (mm)	L (mm)	
23371	16	300	10/50
23390	16	600	5/30
23411	16	900	4/20
23372	18	300	10/50
23391	18	600	5/30
23412	18	900	4/20
23373	20	300	8/40
23392	20	600	4/20
23413	20	900	2/10
23374	22	300	6/30
23393	22	600	4/20
23414	22	900	2/10
23375	24	300	6/30
23394	24	600	4/20
23415	24	900	2/10
23376	25	300	6/30
23395	25	600	4/20
23416	25	900	2/10
23377	26	300	6/30
23396	26	600	2/10
23417	26	900	2/10
23378	28	300	4/20
23397	28	600	2/10
23418	28	900	5
23379	30	300	4/20
23398	30	600	2/10
23419	30	900	5
23380	32	300	4/20
23399	32	600	2/10
23420	32	900	5
23381	35	300	4/20
23400	35	600	2/10
23421	35	900	5
23382	37	300	4/20
23401	37	600	2/10
23422	37	900	5
23383	38	300	4/20
23402	38	600	2/10
23423	38	900	5
23403	40	600	5
23424	40	900	5

PL Dłuto wąskie SDS Plus CZ Sekáč
 GB Flat chisel RO Daltă spatulată
 D Flachmeißel H Lapos véső
 RUS Зубило узкое E Cincel plano



STHOR

No.	Ø (mm)	L (mm)	
23591	20x14	250	25/50

PL Komplet wiertel do betonu
 GB Masonry drill set
 D Betonbohrersatz
 RUS Наб. буров по бетону
 CZ Souprava vrtáků do betonu
 RO Set de burghie pt. beton
 H Fúrószárkészlet betonhoz
 E Juego de brocas



STHOR

No.	Ø mm	pcs	
23988	5; 6; 8; 10; 12x160	5	15/60

PL Grot SDS Plus CZ Špičák
 GB Point chisel RO Dorn
 D Spitzmeißel H Hegyes véső
 RUS Зубило пиковое E Cincel punta



STHOR

No.	Ø (mm)	L (mm)	
23590	14	250	25/50

PL Grot SDS Max CZ Špičák
 GB Point chisel RO Dorn
 D Spitzmeißel H Hegyes véső
 RUS Зубило пиковое E Cincel punta



STHOR

No.	Ø (mm)	L (mm)	
23601	18	280	20/40
23602	18	400	15/30

PL Dłuto wąskie SDS Max CZ Sekáč
 GB Flat chisel RO Daltă spatulată
 D Flachmeißel H Lapos véső
 RUS Зубило узкое E Cincel plano



STHOR

No.	Ø (mm)	L (mm)	
23603	25x18	280	20/40
23604	25x18	400	10/20

PL Dłuto szerokie SDS Plus CZ Sekáč plochý
 GB Spade chisel RO Dalta
 D Spatmeißel H Széles véső
 RUS Зубило плоское широкое E Cincel pala



No.	Ø (mm)	L (mm)	Box
23592	40x14	250	25/50

PL Dłuto szerokie SDS Max CZ Sekáč plochý
 GB Spade chisel RO Dalta
 D Spatmeißel H Széles véső
 RUS Зубило плоское широкое E Cincel pala



No.	Ø (mm)	L (mm)	Box
23605	40x18	280	20/40
23606	50x18	400	10/20

PL Bruzdownik SDS Max CZ Sekáč drážkovací
 GB Groove chisel RO Dalta canal
 D Nutenmeißel H Horonyvésző
 RUS Набор буров и зубил E Cincel acanalado



No.	Ø (mm)	L (mm)	Box
23608	25x18	400	10/20

PL Komplet wiertel i przecinaków do betonu
 GB Hammer drill & chisel set
 D Bohrer und Meißel Satz
 RUS Набор буров и зубил
 CZ Souprava vrtáků + sekáče
 RO Set de burghie + dalte tăietor
 H Fűrészkészlet + hidegvágó
 E Juego de cinceles y brocas



No.	pcs	Box
23586	14	6

PL Dłuto płaskie SDS CZ Sekáč plochý
 GB Flat chisel RO Punctator tip dalta
 D Spatmeißel H Széles lapos véső
 RUS Долото плоское E Cincel plano



No.	Ø (mm)	L (mm)	Box
23594	60	250	25/50

PL Bruzdownik SDS Plus CZ Sekáč drážkovací
 GB Groove chisel RO Dalta canal
 D Nutenmeißel H Horonyvésző
 RUS Набор буров и зубил E Cincel acanalado



No.	Ø (mm)	L (mm)	Box
23593	22x14	250	25/50

PL Komplet wiertel i przecinaków do betonu CZ Souprava vrtáků + sekáče
 GB Hammer drill & chisel set RO Set de burghie + dalte tăietor
 D Bohrer und Meißel Satz H Fűrészkészlet + hidegvágó
 RUS Набор буров и зубил E Juego de cinceles y brocas

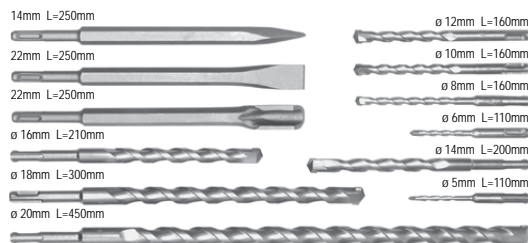

No.	pcs	Box
23585	12	8

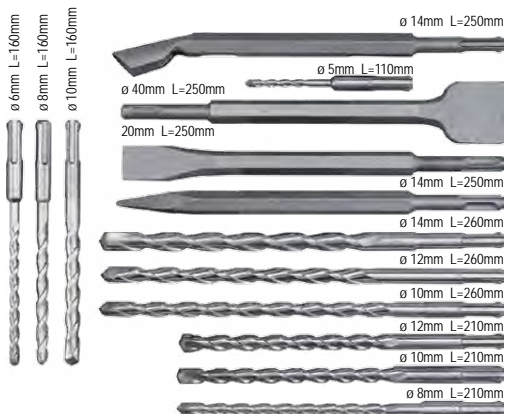

PL Adapter
GB Adapter
D Adapter
RUS Адаптер

CZ Adaptery
RO Adaptor
H Adapter
E Adaptador



STHOR

No.	L (mm)	
23460	60	100/200

PL Wiertło koronowe do muru
GB Hollow drill set
D Bohrkronen
RUS Коронка по бетону
CZ Korunový vrták na zeď - pouzdro šestiúhelník
RO Burghiu cu coroață pt. beton - mandrină hexagonală
H Koronafúró falhoz - hatszögletű szárral
E Broca widia para muro



VOREL

No.	Ø (mm)	
03245	65	24
03246	80	20

PL Wycinarka otworów do drewna
GB Hole saw set
D Lochsägensatz
RUS Пилы кольцевые по дереву в наборе

CZ Vytínač otvorů
RO Tăietor (ferăstrău rotund) pt. orificii
H Lyukasztó
E Sierra de corona para madera



VOREL

No.	Ø (mm)	pcs	
22565	51; 76; 89	4	12/48

PL Zestaw wycinarek do otworów w drewnie
GB Hole saw set
D Lochsägensatz
RUS Пилы кольцевые по дереву в наборе

CZ Vytínač otvorů
RO Tăietor (ferăstrău rotund) pt. orificii
H Lyukasztó
E Juego de sierras de corona



VOREL

No.	Ø (mm)	pcs	
22570	19-64	11	12/36

PL Wiertło koronowe do muru
GB Hollow drill set
D Bohrkronen
RUS Коронка по бетону
CZ Korunový vrták na zeď - pouzdro šestiúhelník
RO Burghiu cu coroață pt. beton - mandrină hexagonală
H Koronafúró falhoz - hatszögletű szárral
E Broca widia para muro



VOREL

No.	Ø (mm)	
03240	65	24
03241	80	20

PL Wycinarka do płyt gipsowych
GB Drywall circle cutter
D Schnitzzirkel für Gipsplatten
RUS Резак круговой по гипсокартону

CZ Vystřihávačka pro sádrové desky
RO Tăietoare pt. plăci de ghips
H Gipszfalkivágó
E Compas cortador para planchas de escayola



VOREL

No.	Ø (mm)	
03990	30-400	12/48

PL Wycinarka otworów do drewna
GB Hole saw set
D Lochsägensatz
RUS Пилы кольцевые по дереву в наборе
CZ Vytínač otvorů
RO Tăietor (ferăstrău rotund) pt. orificii
H Lyukasztó
E Sierra de corona para madera



VOREL

No.	Ø (mm)	pcs	
22572	38-127	9	6/24

PL Zestaw wycinarek do otworów w drewnie
GB Hole saw set
D Lochsägensatz
RUS Пилы кольцевые по дереву в наборе

CZ Vytínač otvorů
RO Tăietor (ferăstrău rotund) pt. orificii
H Lyukasztó
E Juego de sierras de corona



VOREL

No.	Ø (mm)	pcs	
22571	64-127	8	6/24

PL Wyrzynarka do drewna, hartowane zęby
GB Hole saw for wood with hardened teeth
D Lochsägensatz
RUS Пилы кольцевые по дереву закалённые зубья

CZ Vyřezávací pila kalená
RO Set freze circulare cu dinti caliti
H Szűrőfűrész edzett
E Sierra de corona curtidó



No.	Ø (mm)	L (mm)	☐
28680	26; 32; 38; 45; 50; 56; 63	17	10/100
28690	26; 32; 38; 45; 50; 56; 63	45	10/80

PL Zestaw wycinarek do otworów
GB Hole saw set
D Lochsägensatz
RUS Пилы кольцевые по дереву

CZ Vyřinač otvorů
RO Set freze
H Lyukaszó
E Cortador de agujeros

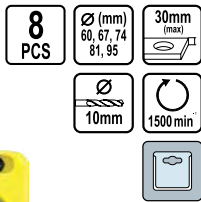

VOREL

No.	Ø (mm)	pcs	☐
28725	60; 67; 74; 81; 95	8	6/24

PL Zestaw wycinarek wolframowych
GB Tungsten carbide coated hole saw set
D Lochbohrersatz
RUS Коронки вольфрамовые

CZ Sada dřeváčích vrtáků pro keramiku
RO Set freze + maner
H Körkivőgő készlet wolfram borítással
E Juego de punzones de wolframio



VOREL

No.	Ø (mm)	☐
03300	33; 53; 67; 73	20
03301	33; 53; 67; 83	20

PL Wiertło do szkła i ceramiki
GB Drill for glass
D Bohrer für Glas
RUS Сверло по стеклу

CZ Vrták do skla
RO Burghiu pt. sticlă
H Üvegűró
E Broca para vidrio

STOR

No.	Ø (mm)	L (mm)	☐
21700	3	60	125/500
21701	4	60	125/500
21702	5	70	125/500
21703	6	75	125/500
21704	8	80	125/500
21705	10	100	125/500
21706	12	100	100/400

PL Wyrzynarka do drewna
GB Hole saw for wood
D Lochsägensatz
RUS Пилы кольцевые по дереву

CZ Vyřezávací pila
RO Set freze decupat lemn
H Szűrőfűrész
E Sierra de corona



No.	Ø (mm)	L (mm)	☐
28710	26; 32; 38; 45; 50; 56; 63	17	10/100
28720	26; 32; 38; 45; 50; 56; 63	45	10/80

PL Otwornica do PCV
GB PVC Hole cutter
D PVC Lochmesser
RUS Сверло по дереву, гипсокартону, ПВХ
CZ Otvornice na PVC
RO Dispozitiv decupat PVC
H Lyukaszó PVC
E Cortador de agujeros de PVC

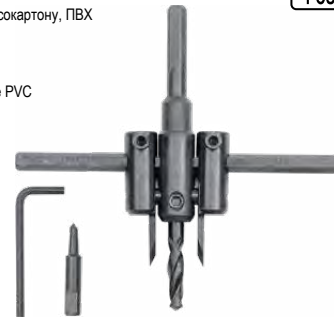

No.	Ø (mm)	pcs	☐
28733	30-120	3	6/60

PL Wiertło do szkła i glazury
GB Tile and glass drill
D Glass- und Fliesbohrer
RUS Сверло по плитке и стеклу

CZ Vrták do skla a glazury
RO Burghiu pt. sticlă și glazură
H Üveg-és csempefűró
E Broca para cristal y azulejos



VOREL

No.	L (mm)	☐
05540	4	50/100
05560	6	50/100
05580	8	50/100
05600	10	50/100

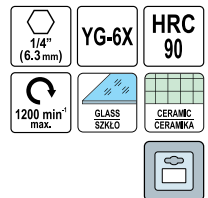

PL Zestaw wiertel do szkła i ceramiki
 GB Glass and tile drills
 D Glas- und Fliesenbohrer
 RUS Набор сверл по стеклу и керамике

CZ Vrtáky do skla a keramiky
 RO Set burghie pt. sticla si ceramica
 H Üveg és kerámi fúrók
 E Juego de brocas, ceramica



STHOL

8

No.	Ø (mm)	pcs	Box
21709	4; 5; 6; 8; 10	5	25/100

PL Gwintownik maszynowy
 GB Machine taps
 D Maschinengewindebohrer
 RUS Метчик машинный

CZ Strojni závitník
 RO Tăroț de mașină
 H Gépi menetfúró
 E Macho mecanico



No.	Ø M	Box
24960	M3	25/100
24961	M4	25/100
24962	M5	25/100
24963	M6	25/100
24964	M8	25/100
24965	M10	25/100
24966	M12	25/100

PL Narzynka
 GB Circular die
 D Schneideisen
 RUS Пластина

CZ Kruhová závitová čelist
 RO Fileră
 H Menetvágó
 E Cojinete de rosca



No.	Ø M	Box
24500	M3	25/100
24510	M4	25/100
24520	M5	25/100
24530	M6	25/100
24550	M8	25/100
24570	M10	25/100
24590	M12	25/100
24610	M14	25/100
24630	M16	15/60
24650	M18	30/60
24670	M20	15/60

PL Gwintowniki
 GB Hand taps
 D Handgewindebohrer
 RUS Метчик

CZ Závitníky
 RO Tărozi
 H Menetfúró
 E Machos de rosca



No.	M	pcs	Box
24300	M3	3	25/100
24310	M4	3	25/100
24320	M5	3	25/100
24330	M6	3	25/100
24340	M7	3	25/100
24350	M8	3	25/100
24370	M10	3	25/100
24390	M12	3	25/100
24410	M14	3	20
24430	M16	3	20
24450	M18	3	20
24470	M20	3	20

PL Komplet gwintowników
 GB Hand tap set
 D Innengewindebohrersatz
 RUS Набор метчиков

CZ Souprava závitníků
 RO Set de țarozi
 H Menetfúró készlet
 E Juego de machos de rosca



No.	Ø M	pcs	Box
24940	M3; M4; M5; M6; M7; M8; M10; M12	25	60

PL Komplet gwintowników i narzynek
GB Tap and die set
D Gewindeschneidwerkzeugsatz
RUS Набор плашек и метчиков

CZ Souprava závitníků a kruhových závitových čelistí
RO Set de tarozi și filiere
H Menetfúró és menetvágó készlet
E Juego de machos de rosca y cojinetes

32
PCS

No.	Ø M	pcs	
24900	M3; M4; M5; M6; M8; M10; M12	32	5

PL Grzechotka do gwintownika
GB Ratchet tap wrench
D Gewindebohrerratsche
RUS Вороток для метчиков с трехзубкой

CZ Řečtačka na závitník
RO Cheie cu clichet pt. tarod
H Racsnis hajtószár menetfúróhoz
E Carraca para macho de rosca



No.	Ø M	
24700	M3-M8	25/100
24710	M5-M12	25/100

PL Oprawka do narzynek
GB Die holder
D Schneideisenhalter
RUS Плашкодержатель

CZ Závitová objímka
RO Portfilieră
H Menetvágó tartó
E Portacojinete



No.	mm	
24800	20x7	30
24810	25x9	25
24813	30x11	25
24820	38x14	30
24823	45x16	20

PL Komplet narzynek
GB Die set
D Aussengewindeschneidesatz
RUS Набор плашек

CZ Souprava kruhových závitových čelistí
RO Set de filiere
H Menetvágó készlet
E Juego de cojinetes

9
PCS

No.	Ø M	pcs	
24950	M3; M4; M5; M6; M7; M8; M10; M12	9	60

PL Pokrętło do gwintownika
GB Tap wrench
D Windeisen
RUS Вороток для метчиков

CZ Ovládací kolečko na závitník
RO Cheie (măner) pt. tarod
H Hajtószár menetfúróhoz
E Llave giramachos



No.	Ø M	
24730	M4-M8	30
24740	M9-M12	25
24750	M13-M18	20

PL Komplet gwintowników i narzynek
GB Tap and die set
D Gewindeschneidwerkzeugsatz
RUS Набор плашек и метчиков

CZ Souprava závitníků a kruhových závitových čelistí
RO Set de tarozi și filiere
H Menetfúró és menetvágó készlet
E Juego de machos de rosca y cojinetes



No.	Ø M	
24295	M3x0.5; M4x0.7; M5x0.8; M6x1; M8x1.25; M10x1.5; M12x1.75	10/20

- PL Wykrętki do zerwanych śrub CZ Vrtáky do přetržených šroubu
 GB Screw extractor set RO Set extractoare pt. prezoane / suruburi
 D Schraubensdrehersatz H Törtszavar kihajtó
 RUS Экстракторы обломанных болтов E Destornillador para tornillos arrancados



No.	size / rozmiar	pcs	box
24000	1/8" (3.2 mm) - 1/4" (6.3 mm)	5	12/120
	1/4" (6.3 mm) - 5/16" (7.9 mm)		
	5/16" (7.9 mm) - 7/16" (11.1 mm)		
	7/16" (11.1 mm) - 9/16" (14.3 mm)		
	9/16" (14.3 mm) - 3/4" (19.0 mm)		

- PL Komplet frezów do drewna CZ Souprava frézů do dřeva
 GB Router bit set RO Set de freze pt. lemn
 D Oberfräsersatz H Marókkészlet fához
 RUS Набор сверл Форстнера по дереву E Juego de frezas para madera



No.	L (mm)	Ø (mm)	pcs	box
22551	15; 20; 25; 30; 35	8	5	5/20

- PL Tarcza diamentowa "segment" CZ Diamantový kotouč segmentový
 GB Diamond blade segmented RO Disc diamantat segmentat
 D Diamanttrennscheibe H Szegmens gyémántkorong
 RUS Диск алмазный сегментированный E Disco de diamante de segmentos



No.	Ø (mm)	min-1	box
08710	110	12000	20/200
08711	115	12000	20/200
08712	125	11000	20/160
08714	180	8000	15/60
08715	230	6500	10/40

- PL Komplet frezów do drewna CZ Souprava frézů do dřeva
 GB Router bit set RO Set de freze pt. lemn
 D Oberfräsersatz H Marókkészlet fához
 RUS Набор сверл Форстнера по дереву E Juego de frezas para madera



No.	Ø (mm)	pcs	box
22550	8	12	5/20

- PL Tamiki trzpieniowe CZ Hrotové rašple
 GB Rotary file set RO Raspeluri cu coadă
 D Profil-Fräsersatz H Fareszelőkészlet, csapszárás
 RUS Набор фасонных фрез E Escofinas

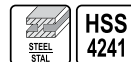
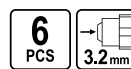

No.	pcs	box
25405	6	50/300

- PL Tarcza diamentowa "segment" CZ Diamantový kotouč segmentový
 GB Diamond blade segmented RO Disc diamantat segmentat
 D Diamanttrennscheibe H Szegmens gyémántkorong
 RUS Диск алмазный сегментированный E Disco de diamante de segmentos



No.	Ø (mm)	min-1	box
08780	115x7.0x1.9x22.2	13200	20/120
08781	125x7.0x2.0x22.2	12000	20/120
08782	180x7.0x2.3x22.2	8400	15/45
08783	230x7.0x2.4x22.2	6600	10/30

- PL Tarcza diamentowa pełna
GB Diamond blade continuous rim
D Diamanttrennscheibe
RUS Диск алмазный сплошной
- CZ Diamantový kotouč /plný/
RO Disc diamantat margine continua
H Gyémántkorong /teljes/
E Disco de diamante /entero/



No.	Ø (mm)	min-1	☐
08731	115	12000	20/200
08732	125	11000	20/160
08734	180	8000	15/60
08735	230	6500	10/40

- PL Tarcza diamentowa „Turbo”
GB Diamond blade „Turbo”
D Diamanttrennscheibe „Turbo”
RUS Отрезной алмазный диск „TURBO”
- CZ Diamantový kotouč /Turbo/
RO Disc diamantat Turbo
H Gyémántkorong /Turbo/
E Disco de diamante /Turbo/



No.	Ø (mm)	min-1	☐
08751	115	12000	20/200
08752	125	11000	20/160
08754	180	8000	15/60
08755	230	6500	10/40

- PL Brzeczot diamentowy
GB Diamond rod saw
D Diamantsägekordel
RUS Полотно алмазное
- CZ Lanko pilové diamentové
RO Panze diamantate
H Fűrészlap-pálca, gyémántbevonatú
E Hoja de sierra de diamante

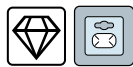

No.	L (mm)	☐
27575	300	20/100

- PL Tarcza diamentowa pełna
GB Diamond blade continuous rim
D Diamanttrennscheibe
RUS Диск алмазный сплошной
- CZ Diamantový kotouč /plný/
RO Disc diamantat margine continua
H Gyémántkorong /teljes/
E Disco de diamante /entero/

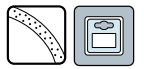

No.	Ø (mm)	min-1	☐
08785	115x5.0x1.9x22.2	13200	20/120
08786	125x5.0x2.0x22.2	12000	20/120
08787	180x5.0x2.3x22.2	8400	15/45
08788	230x5.0x2.4x22.2	6600	10/30

- PL Tarcza diamentowa „Turbo”
GB Diamond blade „Turbo”
D Diamanttrennscheibe „Turbo”
RUS Отрезной алмазный диск „TURBO”
- CZ Diamantový kotouč /Turbo/
RO Disc diamantat Turbo
H Gyémántkorong /Turbo/
E Disco de diamante /Turbo/



No.	Ø (mm)	min-1	☐
08790	115x7.0x2.0x22.2	13200	20/120
08791	125x7.0x2.1x22.2	12000	20/120
08792	180x7.5x2.4x22.2	8400	15/45
08793	230x7.5x2.6x22.2	6600	10/30

- PL Pila tarczowa do drewna z węglikiem wolframu
GB TCT circular saw blade for wood
D Kreissägeblatt HM-Bestückt
RUS Диск пильный с карбидом вольфрама
CZ Kotoučová pila na drevo z karbidem wolframu
RO Ferăstrău circular cu dinți din wolfram pt. lemn
H Wolframkarbidos körfűrész fához
E Disco de sierra con carbono de tungsteno

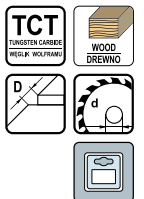

No.	Ø (mm)	Ø d (mm)	R.P.M. max.	D (mm)	metal disc thickness / grubość tarczy (mm)	number of teeth / ilość zębów (T)	☐
08811	140	20	9600	2.0	1.3	16	25/50
08819	160	20	8300	2.0	1.4	18	25/50
08820	160	30	8300	2.0	1.4	24	25/50
08821	160	30	8300	2.0	1.4	36	25/50



- PL Pila tarczowa do drewna z węglikiem wolframu
- GB TCT circular saw blade for wood
- D Kreissägeblatt HM-Bestückt
- RUS Диск пильный с карбидом вольфрама
- CZ Kotoučová pila na dřevo z karbidem wolframu
- RO Ferăstrău circular cu dinți din wolfram pt. lemn
- H Wolframkarbidos körfűrészlap fához
- E Disco de sierra con carbono de tungsteno



- PL Pila tarczowa do aluminium z węglikiem wolframu
- GB TCT circular saw blade for aluminium
- D Hartmetallbestückt Kreissägeblatt für Aluminium
- RUS Диск пильный по алюминию
- CZ Kotoučová pila na hliník s karbidem wolframu
- RO Disc circular pt. aluminiu
- H Wolframkarbidos körfűrészlap, alumíniumhoz
- E Disco de sierra con carbono

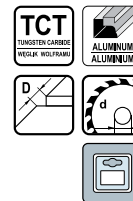

8



No.	Ø (mm)	Ø d (mm)	R.P.M. max.	D (mm)	metal disc thickness / grubość tarczy (mm)	number of teeth / ilość zębów (T)	
08822	160	20	8300	2.0	1.4	48	25/50
08825	184	30	7400	2.2	1.4	24	10/20
08827	184	30	7400	2.2	1.4	40	10/20
08828	185	20	7400	2.2	1.4	18	10/20
08829	200	30	6500	2.2	1.6	24	10/20
08831	210	30	6500	2.2	1.6	40	10/20
08832	210	30	6500	2.2	1.6	60	10/20
08833	250	30	5400	3.0	1.8	24	10/20
08834	250	30	5400	3.0	1.8	40	10/20
08835	250	30	5400	3.0	1.8	60	10/20
08836	300	30	4500	3.2	2.0	24	10
08837	300	30	4500	3.2	2.0	40	10
08838	300	30	4500	3.2	2.0	60	10
08845	350	30	3800	3.2	2.2	40	10
08851	400	30	3300	3.2	2.2	60	10

- PL Tarcza do cięcia metalu
- GB Metal cutting disc
- D Trennscheibe für Metall
- RUS Диск отрезной по металлу
- CZ Souprava kotoučů pro řezání kovu
- RO Set de pânze de tăiat metal
- H Vágókorong készlet fémhez
- E Disco cortador para metalo plano



No.	Ø (mm)	min-1	
08170	115x1.0x22	13200	25/200
08174	115x3.0x22	13200	25/200
08171	125x1.0x22	12200	25/200
08175	125x3.0x22	12200	25/200
08177	230x3.0x22	6500	25/50



No.	Ø (mm)	Ø d (mm)	R.P.M. max.	D (mm)	metal disc thickness / grubość tarczy (mm)	number of teeth / ilość zębów (T)	
08853	210	30	6500	2.2	1.6	72	10/20
08854	250	30	5400	3.0	1.8	100	10/20
08855	300	30	4500	3.2	2.0	100	10

- PL Tarcza do cięcia metalu
- GB Metal cutting disc
- D Trennscheibe für metall
- RUS Диск отрезной по металлу
- CZ Souprava kotoučů pro řezání kovu
- RO Set de pânze de tăiat metal
- H Vágókorong készlet fémhez
- E Disco cortador para metalo plano



No.	Ø (mm)	min-1	
08630	115x1.0x22	12000	25/200
08633	115x2.5x22	13300	25/200
08631	125x1.0x22	11000	25/200
08635	125x2.5x22	12200	25/200
08636	125x3.2x22	12200	25/200
08638	180x2.5x22	8500	25/100
08639	230x1.6x22	6600	25/50
08640	230x3.2x22	6600	25/50
08641	230x2.5x22	6600	25/50
08642	300x3.2x32	5100	10/20
08644	350x3.5x32	4400	10/20
08646	400x4.0x32	3800	10/20

- PL Tarcza do szlifowania metalu wypukła
- GB Metal grinding disc - depressed centre
- D Metall-Schleifscheibe gewölbt
- RUS Диск шлифовальный по металлу
- CZ Kotouč pro broušení kovu
- RO Disc pt. șlefuit metal
- H Vágókorong fémhez
- E Disco de pulir de metalo



No.	Ø (mm)	min-1	
08663	115x6.0x22	13300	25/100
08665	125x6.8x22	11000	25/100
08669	230x6.8x22	6600	25/50

- PL Tarcza do cięcia metalu wypukła
 GB Metal cutting disc - depressed centre
 D Metall-Trennscheibe gewölbt
 RUS Диск отрезной по металлу выпуклый
- CZ Souprava kotoučů pro řezání kovů
 RO Set de pânze de tăiat metal
 H Vágókorong készlet fémhez
 E Disco cortador para metalo concavo



No.	Ø (mm)	min-1	
08186	125x3.0x22	12200	25/200
08188	230x3.0x22	6500	25/50

- PL Tarcza do cięcia kamienia
 GB Stone cutting disc
 D Stein-Trennscheibe
 RUS Диск отрезной по камню
- CZ Kotouč pro řezání kamene
 RO Disc pt. tăiat piatră
 H Vágókorong kőhöz
 E Disco cortador de piedra



No.	Ø (mm)	min-1	
08671	115x3.2x22	13200	25/200
08672	125x3.2x22	12200	25/200
08674	230x3.2x22	6600	25/50

- PL Tarcza do szlifowania kamienia wypukła
 GB Stone grinding disc - depressed centre
 D Stein-Schleifscheibe gewölbt
 RUS Диск шлифовальный по камню
- CZ Kotouč pro broušení kamene
 RO Disc pt. șlefuit piatră
 H Csiszolókorong kőhöz
 E Disco de pulir de piedra



No.	Ø (mm)	min-1	
08683	125x6.8x22	11000	25/100

- PL Tarcza do szlifowania metalu wypukła
 GB Metal grinding disc - depressed centre
 D Metall-Schleifscheibe gewölbt
 RUS Диск шлифовальный по металлу выпуклый
- CZ Kotouč pro broušení kovů
 RO Disc pt. șlefuit metal
 H Vágókorong fémhez
 E Disco de pulir de metalo



No.	Ø (mm)	min-1	
08190	115x6.0x22	13200	25/100
08191	125x6.0x22	12200	25/100
08193	230x6.0x22	6500	10/20

- PL Tarcza do cięcia kamienia wypukła
 GB Stone cutting disc - depressed centre
 D Stein-Trennscheibe gewölbt
 RUS Диск отрезной по камню
- CZ Kotouč pro řezání kamene
 RO Disc pt. tăiat piatră
 H Vágókorong kőhöz
 E Disco cortador de piedra



No.	Ø (mm)	min-1	
08200	115x3.0x22	13200	25/200
08201	125x3.0x22	12200	25/200

- PL Ściernica listkowa talerzowa
 GB Abrasive disc
 D Lameller
 RUS Диск лепестковый
- CZ Kotouč brusný lamelový
 RO Disc abraziv
 H Lamellás csiszoló
 E Disco abrasivo



No.	type	Ø (mm)	min-1	
07974	P40	115	13300	50/200
07975	P60	115	13300	50/200
07976	P80	115	13300	50/200
07977	P100	115	13300	50/200
07978	P120	115	13300	50/200
07984	P40	125	12300	50/200
07985	P60	125	12300	50/200
07986	P80	125	12300	50/200
07987	P100	125	12300	50/200
07988	P120	125	12300	50/200

PL Tarcza łańcuchowa
GB Chain disc
D Kettentrennscheibe
RUS Круг отрезной цепной

CZ Řetězové kolo
RO Disc circular pt. lemn
H Lánctárcsa
E Disco de cadena



No.	Ø (mm)	min-1	
08770	115	12000	10
08771	125	12000	10

PL Tarcza do szlifierki stolowej
GB Grinding disc
D Schleifscheibe
RUS Круг для настольного точильного станка

CZ Brusný kotouč
RO Discul abraziv
H Kőszörűkő
E Disco abrasivo



No.	Ø (mm)	min-1	
08860	125x12.7x17	5850	coarse-grained / gruboziamisty / 10
08861	125x12.7x17	5850	fine-grained / drobnoziarnisty / 10
08864	150x12.7x16	5350	coarse-grained / gruboziamisty / 10
08865	150x12.7x17	5350	fine-grained / drobnoziarnisty / 10
08868	150x31.75x25	5350	coarse-grained / gruboziamisty / 10
08869	150x31.75x25	5350	fine-grained / drobnoziarnisty / 10
08873	200x15.88x20	3850	fine-grained / drobnoziarnisty / 10
08875	200x31.75x30	3850	fine-grained / drobnoziarnisty / 10

PL Nożyce do blachy
GB Figure tin snips
D Blechscher
RUS Ножницы по металлу

CZ Nůžky na plech
RO Foarfece pt. tablă
H Lemezvágó olló
E Tijeras para hojalata



No.	L (mm)	max (mm)	
48060	250	1.2	6/48

PL Tarcza do szlifierki stolowej
GB Grinding disc
D Schleifscheibe
RUS Круг для настольного точильного станка

CZ Brusný kotouč
RO Discul abraziv
H Kőszörűkő
E Disco abrasivo



No.	Ø (mm)	min-1	
08876	200x20x40	3850	5

PL Nożyce do blachy
GB Figure tin snips
D Blechscher
RUS Ножницы по металлу

CZ Nůžky na plech
RO Foarfece pt. tablă
H Lemezvágó olló
E Tijeras para hojalata

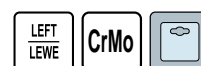

No.	L (mm)	max (mm)	
48000	250	1.5	6/36

PL Nożyce do blachy
GB Figure tin snips
D Blechscher
RUS Ножницы по металлу

CZ Nůžky na plech
RO Foarfece pt. tablă
H Lemezvágó olló
E Tijeras para hojalata

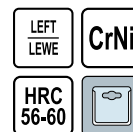

No.	L (mm)	max (mm)	
48080	250	1.0	6/36

PL Nożyce do blachy CZ Nůžky na plech
 GB Figure tin snips RO Foarfece pt. tablă
 D Blechscherer H Lemezvágó olló
 RUS Ножницы по металлу E Tijeras para hojalata



No.	L (mm)	
48100	250	6/60

PL Nożyce do blachy CZ Nůžky na plech
 GB Figure tin snips RO Foarfece pt. tablă
 D Blechscherer H Lemezvágó olló
 RUS Ножницы по металлу E Tijeras para hojalata



No.	L (mm)	
48200	250	6/60

PL Nożyce do blachy CZ Nůžky na plech
 GB Figure tin snips RO Foarfece pt. tablă
 D Blechscherer H Lemezvágó olló
 RUS Ножницы по металлу E Tijeras para hojalata



No.	L (mm)	max (mm)	
48070	250	1.2	6/48

PL Nożyce do blachy CZ Nůžky na plech
 GB Figure tin snips RO Foarfece pt. tablă
 D Blechscherer H Lemezvágó olló
 RUS Ножницы по металлу E Tijeras para hojalata



No.	L (mm)	
48150	250	6/60

PL Nożyce do blachy CZ Nůžky na plech
 GB Figure tin snips RO Foarfece pt. tablă
 D Blechscherer H Lemezvágó olló
 RUS Ножницы по металлу E Tijeras para hojalata



No.	L (mm)	max (mm)	
48082	250	1.0	6/36

PL Nożyce do blachy CZ Nůžky na plech
 GB Figure tin snips RO Foarfece pt. tablă
 D Blechscherer H Lemezvágó olló
 RUS Ножницы по металлу E Tijeras para hojalata



No.	L (mm)	max (mm)	
48050	250	1.5	6/36

PL Nożyce do blachy CZ Nůžky na plech
 GB Figure tin snips RO Foarfece pt. tablă
 D Blechscherer H Lemezvágó olló
 RUS Ножницы по металлу E Tijeras para hojalata



No.	L (mm)	max (mm)	
48081	250	1.0	6/36

PL Nożyce do blachy CZ Nůžky na plech
 GB Figure tin snips RO Foarfece pt. tablă
 D Blechscherer H Lemezvágó olló
 RUS Набор ножниц по металлу E Tijeras para hojalata



No.	L (mm)	pcs	
48330	250	3	5/20

- PL Nożyce do drutu
GB Bolt cutter
D Drahtschere
RUS Болторез
- CZ Nůžky na drát
RO Cleste pt. buioane
H Drótvágó olló
E Tijeras para alambre



No.	L (mm)	Icon
49200	200	15/60

- PL Nożyce do prętów
GB Bolt cutter
D Bolzenschneider
RUS Болторез
- CZ Nůžky na tyče
RO Cleste pt. buioane
H Kábelvágó olló
E Tijeras para barras



No.	L (mm)	Icon
49450	450	20
49600	600	10
49750	750	5

- PL Nożyce wielofunkcyjne do węży, rurek, listew
GB Miter shears
D Mitre Scheren
RUS Ножницы угловые для пластмассовых и резиновых профилей
CZ Úhlové nůžky
RO Foarfeca de mana pt. taiat garnituri
H Gérvágó olló
E Tijera corte ingles



No.	Ø (mm)	Icon
48350	17, 20, 27	6/24

- PL Pila do drewna
GB Hand saw for wood
D Handsäge
RUS Пила по дереву
- CZ Pila na dřevo
RO Fierastrau „coada de vulpe” - pt. lemn
H Fafűrész, egyenes
E Sierra de mano



No.	L (mm)	Icon
28380	400	10/40
28381	450	10/40
28382	500	10/40

- PL Glowica do nożyc do drutu
GB Bolt cutter head
D Schneiden für Bolzenschneider
RUS Головка для болтореза
- CZ Hlava nůžek na tyče
RO Cap pt. cleste buioane
H Fej a kábelvágó ollóhoz
E Cabezal de tijeras para barras



No.	L (mm)	for / dla	Icon
49460	450	49450	10/30
49760	750	49750	5/20

- PL Nożyce do prętów profesjonalne
GB Bolt cutter
D Bolzenschneider
RUS Болторез „ПРОФИ”
- CZ Nůžky na tyče
RO Cleste pt. buioane
H Kábelvágó olló
E Tijeras para barras



No.	L (mm)	Ø (mm)	Icon
49770	350	6	24
49771	450	8	12
49772	600	10	12
49773	750	12	6
49774	900	14	4
49775	1050	16	2

- PL Pila płatnica
GB Hand saw for wood
D Handsäge
RUS Пила по дереву
CZ Pila na dřevo
RO Fierastrau „coada de vulpe” - pt. lemn
H Fafűrész, egyenes
E Sierra de mano

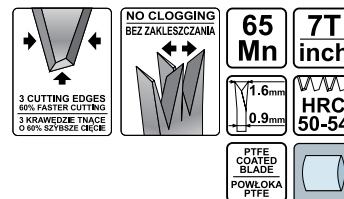

No.	L (mm)	Icon
28385	400	12/48
28386	450	10/40
28387	500	10/40

PL Pila do drewna CZ Pila na dřevo
 GB Hand saw for wood RO Fierastrău „coada de vulpe” - pt. lemn
 D Handsäge H Fafűrész, egyenes
 RUS Пила по дереву E Sierra de mano



No.	L (mm)	
28394	400	12/60
28395	450	12/60

PL Pila kabląkowa CZ Oblouková pila
 GB Bow saw RO Ferăstrău de curbură
 D Bűgelsäge H Keretes fűrész
 RUS Лучковая пила по дереву E Sierra de arco



No.	L (mm)	
28745	530	12/24

PL Brzesczot CZ Ostří na dřevo
 GB Spare blade for bow saw RO Panza fierastrău tip arc
 D Bűgelsägeblatt H Fűrészlap fához
 RUS Полотно для лучковой пилы по сырому дереву E Hoja de sierra



300 mm



No.	L (mm)	W (mm)	
28771	530	20	60/240
28772	610	20	60/240
28773	760	20	60/240

PL Pila do gazobetonu CZ Pila na plynobeton
 GB Saw for gas concrete RO Fierastrău cu placute vidia pt. BCA
 D Gasbetonsäge H Fűrész gázbetonhoz
 RUS Пила по газобетону с твердосплавным зубом E Sierra para gas hormigon

600 mm



No.	L (mm)	teeth / zęby	
28000	600	33/33	5
28010	600	33/17	5

PL Pila kabląkowa CZ Oblouková pila
 GB Bow saw RO Ferăstrău de curbură
 D Bűgelsäge H Keretes fűrész
 RUS Лучковая пила по дереву E Sierra de arco



No.	L (mm)	
28740	525	24
28750	750	24

PL Pila kabląkowa CZ Oblouková pila
 GB Bow saw RO Ferăstrău de curbură
 D Bűgelsäge H Keretes fűrész
 RUS Лучковая пила по дереву E Sierra de arco



No.	L (mm)	
28746	610	12/24
28755	760	12/24

PL Pila otwornica CZ Pila otvornice
 GB Compass saw RO Ferăstrău coadă de șoarece
 D Astsäge H Lyukfűrész
 RUS Пила выкружная E Sierra compas

300 mm



No.	L (mm)	
28650	300	30/120

PL Pila do gazobetonu CZ Pila na plynobeton
 GB Saw for gas concrete RO Fierastrău cu placute vidia pt. beton
 D Gasbetonsäge H Fűrész gázbetonhoz
 RUS Пила по газобетону с твердосплавным зубом E Sierra para gas hormigon



No.	L (mm)	teeth / zęby	
28011	600	15	6/12
28012	660	34	6/12

PL Pila do metalu CZ Pila na kov
 GB Hacksaw frame RO Ferăstrău pt. metal
 D Metallsägebogen H Fémfűrész
 RUS Ножовка по металлу E Sierra de metalo

300 mm



No.	L (mm)	
27000	300	12/48

PL Pila do metalu CZ Pila na kov
 GB Hacksaw frame RO Ferăstrău pt. metal
 D Metallsägebogen H Fémfűrész
 RUS Ножовка по металлу E Sierra de metalo

300 mm

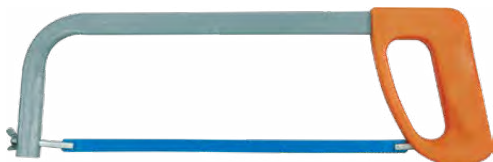

No.	L (mm)	
27200	300	20/60

PL Pila do metalu CZ Pila na kov
 GB Hacksaw frame RO Ferăstrău pt. metal
 D Metallsägebogen H Fémfűrész
 RUS Ножовка по металлу E Sierra de metalo

300 mm



JUCO

No.	L (mm)	
27495	300	5

PL Pila wielofunkcyjna z zestawem 11 akcesoriów CZ Multifunkční ruční dřevěná pila
 GB Multi-functional hand saw with multiple blades RO Fierastrau multifunctional cu lame de rezervă
 D Multifunktionale magische Säge H Varázs fűrész
 RUS Многофункциональная волшебная пила E Sierra mágica multifuncional

<p>Multi-functional hand saw „MAGIC SAW” with multiple blades:</p> <p>I. 8 pcs of blades I-150 mm: a) 6pcs of universal blades for wood, metal, plastics b) 2 pcs of diamond blades: - 1 pc of round diamond blade for glass and tiles - 1 pc of diamond flat blade 6 mm</p> <p>II. 2 pcs of tile cutters III. 1 pc of frame with round blade for cutting glass and with teeth for breaking glass or tiles IV. 1 pc of wing bolt V. 1 pc of flat blade I-175 x 20 mm for wood and plastics</p>	<p>Pila modelerska „MAGIC SAW” z zestawem wymiennych brzoźców:</p> <p>I. 8 brzoźców I-150 mm: a) 6 uniwersalnych do drewna, metalu i tworzyw b) 2 diamentowe: - okrągły diamentowy do ceramiki i szkła - płaski diamentowy 6 mm</p> <p>II. 2 rysiki do ceramiki III. rama z okrągłym nożem do cięcia szkła oraz wycięciami do łamania szkła lub ceramiki IV. nakrętki skrzydełkowa V. brzoźczi płaski I-175 x 20 mm do agresywnego cięcia drewna i tworzyw</p>
---	---

VOREL

No.		
27610		30

PL Pila do metalu CZ Pila na kov
 GB Hacksaw frame RO Ferăstrău pt. metal
 D Metallsägebogen H Fémfűrész
 RUS Ножовка по металлу E Sierra de metalo

300 mm



No.	L (mm)	
27100	300	12/60

PL Pila do metalu CZ Pila na kov
 GB Hacksaw frame RO Ferăstrău pt. metal
 D Metallsägebogen H Fémfűrész
 RUS Ножовка по металлу E Sierra de metalo

300 mm

BI-METAL

24 TPI

AI

METAL



VOREL

No.	L (mm)	
27322	300	6/36

PL Pila do metalu CZ Pila na kov
 GB Hacksaw frame RO Ferăstrău pt. metal
 D Metallsägebogen H Fémfűrész
 RUS Ножовка по металлу E Sierra de metalo

150 mm



No.	L (mm)	
27600	150	30/150



PL Pila poprzeczna CZ Pila bñchotka
 GB Cross - cut saw RO Joagar
 D Bauchsäge H Keresztvágó fűrész
 RUS Пила двуручная E Sierra para corte cruzado



No.	L (cm)	type	
28790	100	L-1000	10

PL Pila kątowa uchylana - 2 kąty cięcia CZ Úhlová pila sklápěcí
 GB Precision miter saw - 2 angles RO Fierastru de taiat la unghi in doua plane
 D Präzisionsgehrungssäge kippbar H Kézifűrész, döntött
 RUS Ступло металлическое наклонное „ПРОФИ” E Sierra de angulo desviado 2 angulos de corte



No.	mm	angle / kąt	
29050	550	45°: 55°: 60°: 72°: 90°	1

PL Skrzynka uciosowa CZ Ustřihací skřínka z umělé hmoty
 GB Plastic miter box RO Cutie din plastic pt. taiat oblic
 D Schneidlade H Vágósablon műanyag
 RUS Ступло пластмассовое E Gria de ingletar de plastic



No.	size / rozmiar (mm)	internal size / rozmiar wewnętrzny (mm)	
29311	250x75x55	45x40	70
29312	285x90x70	55x55	50

PL Skrzynka uciosowa CZ Ustřihací skřínka z umělé hmoty
 GB Plastic miter box RO Cutie din plastic pt. taiat oblic
 D Schneidlade H Vágósablon műanyag
 RUS Ступло пластмассовое E Gria de ingletar de plastic

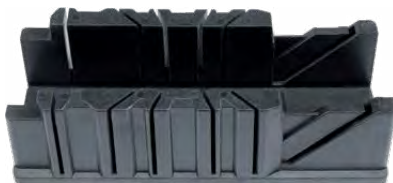

No.	size / rozmiar (mm)	internal size / rozmiar wewnętrzny (mm)	
29317	230x85x65	52x55	50
29318	250x104x70	65x60	50
29319	295x115x80	85x70	30

PL Pila kątowa CZ Úhlová pila
 GB Precision miter saw RO Fierastru pt. taiat la unghi
 D Präzisions-Gehrungssäge H Kézifűrész
 RUS Ступло металлическое „ПРОФИ” E Sierra de angulo

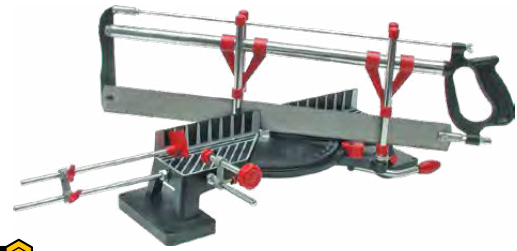
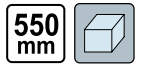

No.	mm	angle / kąt	
29000	550	22.5°: 30°: 36°: 45°: 90°	1

PL Drewniana skrzynka uciosowa CZ Ustřihací skřínka dřevěná
 GB Wooden miter box RO Cutie din lemn pt. taiat oblic
 D Gehrungsschneidlade H Vágósablon fa
 RUS Ступло деревянное E Gria de ingletar de madera



No.	size / rozmiar (mm)	internal size / rozmiar wewnętrzny (mm)	
29210	300x120x60	80x40	10
29220	450x150x80	110x60	12

PL Skrzynka uciosowa CZ Ustřihací skřínka z umělé hmoty
 GB Plastic miter box RO Cutie din plastic pt. taiat oblic
 D Schneidlade H Vágósablon műanyag
 RUS Ступло пластмассовое E Gria de ingletar de plastic



No.	size / rozmiar (mm)	internal size / rozmiar wewnętrzny (mm)	
29313	280x100x100	85x85	30

PL Skrzynka uciosowa CZ Ustřihací skřínka z umělé hmoty
 GB Plastic miter box RO Cutie din plastic pt. taiat oblic
 D Schneidlade H Vágósablon műanyag
 RUS Ступло пластмассовое E Gria de ingletar de plastic



No.	size / rozmiar (mm)	internal size / rozmiar wewnętrzny (mm)	
29323	325x165x95	120x80	18

PL Brzeczczoty do pily szablastej CZ Pilový plátek do pily ocasky
 GB Sabre saw blades RO Pânză de ferăstrău sabie
 D Säbelsägeblatt H Szablyafűrészlap
 RUS Пильное полотно E Hoja de sierra sable

A application: softwood, hardwood, chipboard, plywood, fibreboard, laminated boards
 zastosowanie: miękkie drewno, twarde drewno, płyta wiórowa, sklejka, płyta pilśniowa, płyty laminowane
B application: softwood, hardwood, chipboard, plywood, fibreboard, laminated boards
 zastosowanie: miękkie drewno, twarde drewno, płyta wiórowa, sklejka, płyta pilśniowa, płyty laminowane
C application: softwood, timber, chipboard, plywood, fibreboard, laminated boards
 zastosowanie: miękkie drewno, twarde drewno, płyta wiórowa, sklejka, płyta pilśniowa, płyty laminowane
D application: softwood, timber, chipboard, plywood, fibreboard, laminated boards
 zastosowanie: miękkie drewno, twarde drewno, płyta wiórowa, sklejka, płyta pilśniowa, płyty laminowane
E application: metal, hardwood, chipboard, plywood, laminated boards
 zastosowanie: metal, płyta wiórowa, sklejka, płyta pilśniowa, płyty laminowane
F application: metal, hardwood, chipboard, plywood, laminated boards
 zastosowanie: metal, płyta wiórowa, sklejka, płyta pilśniowa, płyty laminowane
G application: metal, hardwood, chipboard, plywood, laminated boards
 zastosowanie: metal, płyta wiórowa, sklejka, płyta pilśniowa, płyty laminowane

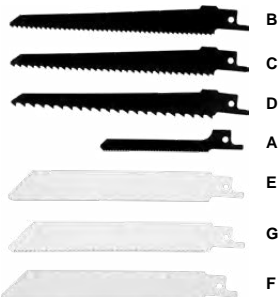

No.	pcs	
27850	7	10/100

PL Brzeczczoty CZ Ćepele
 GB Hacksaw spare blades RO Pânze
 D Metallsägeblatt H Fémfűrészlap
 RUS Полотно двустороннее E Hojas



No.	type	L (mm)	W (mm)	pcs	
27500	RAMB	300	25	72	10



No.	type	L (mm)	W (mm)	pcs	
27501	RAMC	300	12	144	10



No.	type	L (mm)	W (mm)	pcs	
27502	RAMA	300	12	144	10



No.	type	L (mm)	W (mm)	pcs	
27505	RAME	300	20	72	10



No.	type	L (mm)	W (mm)	pcs	
27506	RAMF	300	20	72	10



No.	type	L (mm)	W (mm)	pcs	
27510	RAMD	300	25	72	10

A	WOOD DREWNÓ	92mm 72mm	HCS	14TPI	1,0 mm	
B	WOOD DREWNÓ	150mm 130mm	HCS	8TPI	1,0 mm	
C	WOOD DREWNÓ	150mm 130mm	HCS	6TPI	1,0 mm	
D	WOOD DREWNÓ	150mm 130mm	HCS	4TPI	1,2 mm	
E	STEEL STAL	WOOD DREWNÓ	150mm 130mm	BI-METAL	24TPI	1,0 mm
F	STEEL STAL	WOOD DREWNÓ	150mm 130mm	BI-METAL	18TPI	1,0 mm
G	STEEL STAL	WOOD DREWNÓ	150mm 130mm	BI-METAL	10TPI	1,0 mm

PL Brzeczczoty CZ Ćepele
 GB Hacksaw spare blades RO Pânze
 D Metallsägeblatt H Fémfűrészlap
 RUS Полотно двустороннее E Hojas



No.	type	L (mm)	W (mm)	pcs	
27511	RAMB	300	25	3	50



No.	type	L (mm)	W (mm)	pcs	
27513	RAMD	300	25	3	50

PL Brzeczczoty RAMB do metalu CZ Ćepele
 GB Hacksaw spare blade RO Pânze
 D Metallsägeblatt H Fémfűrészlap
 RUS Полотно двустороннее E Hojas

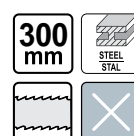

No.	type	L (mm)	W (mm)	
27530	RAMB	300	25	10/70

PL Brzeczczoty RAMF do drewna metalu CZ Ćepele
 GB Hacksaw spare blade RO Pânze
 D Metallsägeblatt H Fémfűrészlap
 RUS Полотно двустороннее E Hojas

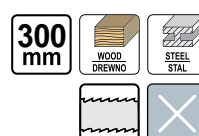

No.	type	L (mm)	W (mm)	
27533	RAMF	300	20	10/70

PL Brzeszczot do metalu
 GB Spare blade for precision miter saw for metal
 D Metallsägeblatt
 RUS Полотна для ножовки по металлу
 CZ Pilový list na kovy
 RO Panza fierastrau metale o fata taietoare
 H Fémfűrész lap
 E Hoja de sierra para metalo



No.	L (mm)	pcs	
27520	300	12	20/120

PL Brzeszczot do drewna i PCV
 GB Spare blade for precision miter saw for wood & PVC
 D PVC und Holzägeblatt
 RUS Полотно по дереву и ПВХ
 CZ Pilový list na dřevo a PVC
 RO Panza fierastrau pt. lemn si PVC
 H Fűrészlap fához és PVC-hez
 E Hoja de sierra para madera y PVC



No.	L (mm)	W (mm)	mm	teeth / inch zęby / cal	
29090	550	45	0.7	18	50

PL Brzeszczoty do wyrzynarki elektrycznej
 GB Jig saw blades
 D Stichsägeblätter
 RUS Полотно для электролобзика

CZ Pilový list do přímočaré pily
 RO Panza fierastrau circular
 H Dekopírlap
 E Recambio sierra de calar



VOREL

No.	mm	pcs	
27810	100/75	5	100/400

VOREL

No.	mm	pcs	
27811	100/75	5	100/400

VOREL

No.	mm	pcs	
27812	100/75	5	100/400

PL Brzeszczoty
 GB Hacksaw spare blades
 D Metallsägeblatt
 RUS Полотно по металлу для МИНИ-НОЖОВКИ

CZ Čepele
 RO Pânze
 H Fémfűrészlap
 E Hojas



No.	L (mm)	pcs	
27800	150	10	8/120

PL Brzeszczot do metalu
 GB Spare blade for precision miter saw for metal
 D Metallsägeblatt
 RUS Полотно по металлу
 CZ Pilový list na kovy
 RO Panza fierastrau pt. metal
 H Fémfűrész lap
 E Hoja de sierra para metalo

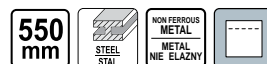

No.	L (mm)	W (mm)	mm	teeth / inch zęby / cal	
29100	550	45	0.7	32	50

PL Brzeszczoty do wyrzynarki elektrycznej
 GB Jig saw blades
 D Stichsägeblätter
 RUS Полотно для электролобзика

CZ Pilový list do přímočaré pily
 RO Panza fierastrau circular
 H Dekopírlap
 E Recambio sierra de calar



VOREL

No.	mm	pcs	
27813	100/75	5	100/400

VOREL

No.	mm	pcs	
27814	76/50	5	100/400

VOREL

No.	mm	pcs	
27815	100/75	5	100/400

VOREL

No.	mm	pcs	
27820	4x100/75; 1x76x50	5	100/400

PL Brzeczoty do wyrzynarki elektrycznej CZ Pilový list do přímočaré pily
 GB Jig saw blades RO Panza fierastrau circular
 D Stichsägeblätter H Dekopírlap
 RUS Полотно для электролобзика E Recambio sierra de calar



No.	mm	pcs	Box
27830	100/75	5	100/400

No.	mm	pcs	Box
27831	100/75	5	100/400

No.	mm	pcs	Box
27832	76/50	5	100/400

No.	mm	pcs	Box
27833	100/75	5	100/400

No.	pcs mm	pcs	Box
27834	4x100/75; 1x76/50	5	100/400

PL Szczotka czolowa z gwintem, drut karbowany CZ Čelní kartáč, rýhovaný drát
 GB Cup brush - crimped wire RO Perie frontală, sărmă ondulată
 D Stahldraht - Topfbürste H Homlok drótkefe, sodrott dróttal
 RUS Щетка-крацевка чашка с гайкой E Cepillo de copa de alambre ondulado



No.	Ø (mm)	min-1	Box
06970	75	12500	12/72
06971	100	8500	6/24

PL Szczotka druciana CZ Drátěný kartáč
 GB Steel wire brush RO Perie de sărmă
 D Stahldrahtbürste H Drótkefe
 RUS Щетка проволочная стальная E Cepillo de acero



No.	rows / rzędy	Box
06930	3	12/120
06940	4	12/120
06950	5	12/120
06960	6	12/120

PL Komplet szczotek drucianych CZ Kartáče
 GB Plastic handle wire brush set RO Perie set
 D Stahlbürstensatz H 3 db-os kefekészlet
 RUS Набор 3-х мини-щёток E Juego de 3 cepillos



No.	L (mm)	Box
06963	170	24/240
06964	220	24/72

PL Szczotka druciana mosiężna CZ Drátěný kartáč mosazný
 GB Brass wire brush RO Perie de sărmă din alamă
 D Messingdrahtbürste H Réz drótkefe
 RUS Щетка проволочная латунная E Cepillo de laton



No.	Box
06965	25/100

PL Szczotka tarczowa, drut karbowany CZ Kotoučový kartáč, rýhovaný drát
 GB Circular brush - crimped wire RO Perie rotundă, sărmă ondulată
 D Stahldraht - Kegelbürste H Tarcás drótkefe, sodrott dróttal
 RUS Щетка-крацевка с гайкой E Cepillo redondo de alambre ondulado



No.	Ø (mm)	min-1	Box
06972	100	12500	12/72
06973	115	12500	12/72

- PL Szczotka czolowa z gwintem, drut splatany
GB Cup brush - twisted wire
D Stahldraht - Zopfborste
RUS Щётка - крацовка круговая крученая
щётка крацовка (чашка)
- CZ Čelní kartáč, pletený drát
RO Perie frontală, sârmă împletită
H Homlok drótkefe, sodrott dróttal
E Cepillo de copa de alambre conico



VOREL

No.	Ø (mm)	min-1	☐
06974	65	12500	12/36
06975	80	8500	12/36
06976	100	8500	6/24

- PL Szczotka tarczowa, drut karbowany
GB Circular brush - crimped wire
D Stahldraht - Scheibenbürste
RUS Щётка-крацовка латунированная сталь
- CZ Kotoučový kartáč
RO Perie rotativă
H Tarcás drótkefe
E Cepillo redondo de alambre ondulado



VOREL

No.	Ø (mm)	min-1	☐
06978	125	6000	12/72
06979	150	6000	12/36
06980	200	4500	12/24

- PL Szczotka tarczowa z trzpieniem, drut karbowany
GB Circular brush - crimped wire
D Stahldraht - Scheibenbürste mit Dorn
RUS Щётка-крацовка со стержнем
CZ Kotoučový kartáč, z hrotem, ťuhovaný drát
RO Perie rotundă cu coadă sârmă ondulată
H Tarcás drótkefe, nyéllel, sodrott dróttal
E Cepillo redondo con mandril de alambre ondulado



VOREL

No.	Ø (mm)	min-1	☐
06985	75	4500	10/120
06986	100	4500	12/120

- PL Szczotki druciane z trzpieniem, drut karbowany
GB Wire brush set
D Stahldraht-Bürstensatz
RUS Набор щеток-крацовок со стержнем
- CZ Okružní kartáč drátěný se stopkou
RO Set perii de sârmă ondulată
H Tarcás drótkefe, nyéllel, sodrott dróttal
E Cepillos de alambre con mandril

**3
PCS**



VOREL

No.	Ø (mm)	min-1	☐
06989	25; 50; 50	4500	12/60

- PL Szczotka tarczowa z gwintem, drut splatany
GB Circular brush - twisted wire
D Stahldraht - Zopf - Kegelfürste
RUS Щётка-крацовка-усиленная
- CZ Kotoučový kartáč, pletený drát
RO Perie rotativă, sârmă împletită
H Tarcás drótkefe, egyenes dróttal
E Cepillo redondo de alambre conico

**100
Ømm**



VOREL

No.	Ø (mm)	min-1	☐
06977	100	12500	12/48

- PL Szczotka tarczowa, drut splatany
GB Circular brush - twisted wire
D Stahldraht - Zopfscheibenbürste
RUS Дисконая щётка витая
- CZ Kotoučový kartáč
RO Perie rotativă
H Tarcás drótkefe
E Cepillo redondo de alambre conico



VOREL

No.	Ø (mm)	min-1	☐
06981	100	11000	12/72
06982	115	11000	12/48
06983	150	9000	12/36

- PL Szczotka czolowa z trzpieniem, drut karbowany
GB Cup brush - crimped wire
D Stahldraht - Topfbürste
RUS Щётка-крацовка со стержнем чашка
CZ Čelní kartáč, z hrotem, ťuhovaný drát
RO Perie frontală cu coadă, sârmă ondulată
H Homlok drótkefe, nyéllel, sodrott dróttal
E Cepillo de copa con mandril, de alambre ondulado



VOREL

No.	Ø (mm)	min-1	☐
06987	50	4500	10/180
06988	75	4500	12/96

- PL Szczotki druciane okrągłe
GB Steel wire brush set
D Stahldraht - Bürstensatz
RUS Набор щеток
- CZ Drátěný kartáče kulaté
RO Perii de sârmă rotunde
H Kerek drótkefe
E Cepillos de alambre redontos



No.	min-1	☐
06990	4500	20/120

- PL Szczotka czolowa z trzpieniem, drut karbowany
GB Cup brush – crimped wire
D Stahldraht - Topfbürste
RUS Щетка-крацовка „КИСТЬ” со стержнем

- CZ Čelní kartáč, z hrotem, rýhovaný drát
RO Perie frontală cu coadă, sârmă ondulată
H Homlok drótkéfe, nyéllel, sodrott dróttal
E Cepillo de copa con mandril, de alambre ondulado



No.	Ø (mm)	min-1	Icon
06992	24	4500	24/192

- PL Szczotka czolowa z trzpieniem, drut splatany
GB Cup brush - twisted wire
D Stahldraht - Zopfgrundbürste
RUS Щетка-крацовка витая со стержнем
CZ Čelní kartáč, z hrotem, pletený drát
RO Perie frontală cu coadă, sârmă împletită
H Homlok drótkéfe, nyéllel, egyenes dróttal
E Cepillo de copa con mandril de alambre conico



No.	Ø (mm)	min-1	Icon
06994	75	12500	12/96
06995	22	4500	24/192

- PL Przystawka z rzepem
GB Rubber disc with velcro
D Klett - Haftstützeller mit Dorn
RUS Насадка резиновая с шестигранным хвостовиком, для дрели

- CZ Přídavné zařízení ze zipem
RO Disc-Suport cu scai pt. hârtie abrazivă rotundă
H Kistál tapadókoronggal
E Disco de goma con velcro



No.	Ø (mm)	min-1	Icon
08312	125	2000	12/120

- PL Euro dysk do kątowniki z rzepem
GB Rubber disc for angle grinder with velcro
D Klett - Haftsteller + Gewindeflansch
RUS Насадка пластиковая жесткая под круг на липучке

- CZ Euro disk do úhelníků ze zipem
RO Suport disc abraziv, fixare scai
H Euro lemez élhez, tapadókoronggal
E Disco de goma para angul con velcro

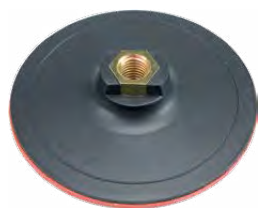

No.	Ø (mm)	min-1	Icon
08315	125	12200	30/120

- PL Szczotka tarczowa z trzpieniem, drut splatany
GB Circular brush - twisted wire
D Stahldraht - Zopfscheibenbürste mit Dorn
RUS Щетка-крацовка витая
CZ Kotoučový kartáč, z hrotem, pletený drát
RO Perie rotativă cu coadă sârmă împletită
H Tarcásás drótkéfe, nyéllel, egyenes dróttal
E Cepillo redondo con mandril de alambre conico



No.	Ø (mm)	min-1	Icon
06993	75	12500	30/180

- PL Rotoflex przegubowy
GB Rotoflex profi
D Rotoflex profi
RUS Насадка резиновая с фиксатором угла наклона, с липучкой, для дрели

- CZ Kloubový rotoflex
RO Suport disc abraziv, fixare scai
H Csuksós rotoflex
E Rotoflex articulado



No.	Ø (mm)	min-1	Icon
08300	125	2000	20

- PL Przystawka-dysk z trzpieniem
GB Rubber disc with arbor
D Klett - Haftsteller + Ersatzdorn
RUS Насадка резиновая с шестигранным хвостовиком, для дрели

- CZ Nástavec-kotouč s upínacím trnem
RO Disc cu știft, ajutoaj
H Csiszoló korong nyéllel
E Disco de goma con mandril



No.	Ø (mm)	min-1	Icon
08314	125	3250	20/120

- PL Przystawka do szlifierek kątownych i wiertarek
GB Rubber disc for angle grinder and drill machine
D Klett - Haftstützsteller mit Gewindeflansch und Ersatzdorn
RUS Насадка шлифовальная, гайка M14 с липучкой+ переход
CZ Kotouč do úhelníků ze zipem
RO Suport disc abraziv, fixare scai
H Euro lemez élhez, tapadókoronggal
E Disco de goma para ancul con mandril

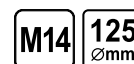

No.	Ø (mm)	min-1	Icon
08316	125	12200	30/120

- PL Tarcza do kątowniki z rzepem
 GB Rubber disc for angle grinder with velcro
 D Klett - Gummihafstüttzsteller mit Gewindeflansch
 RUS Насадка шлифовальная под круг на липучке
 CZ Kotouč do úhelníků ze zipem
 RO Suport disc abraziv, fixare scai
 H Euro lemez élhez, tapadókoronggal
 E Disco para el pulidor angular con sujetador Velcro



VOREL

No.	Ø (mm)	min-1	☐
08318	125	12500	25/100

- PL Przystawka z rzepem
 GB Rubber disc with velcro
 D Klett - Hafstüttzsteller mit Dorn
 RUS Насадка резиновая с хвостовиком и липучкой для дрели
- CZ Přídavné zařízení ze zipem
 RO Suport disc abraziv, fixare scai
 H Kistál tapadókoronggal
 E Disco de goma con velcro



**PRO
FIL**

No.	Ø (mm)	min-1	☐
08400	125	2000	20
08410	150	2000	20

- PL Euro dysk do kątowniki z trzpieniem
 GB Rubber disc for angle grinder with velcro
 D Klett - Hafstüttzsteller mit Gewindeflansch und Ersatzdorn
 RUS Насадка шлифовальная, гайка M14 с липучкой + переход
- CZ Euro disk do úhelníků
 RO Euro disc cu scai pt. polizor unghiular
 H Euro lemez élhez, tapadókoronggal
 E Disco de goma para ancul con mandril



**PRO
FIL**

No.	Ø (mm)	min-1	☐
08501	125	10000	20

- PL Rzep do tarczy gumowej /przylepiec/
 GB Polishing felt disc
 D Klettdisk für Gummistüttzsteller
 RUS Круг с липучкой
- CZ Žip do pryžového kotouče /suchý žip/
 RO Disc pasla de lustruit cu scai
 H Tapadókorong gumitárcsához
 E Velcro para disco de goma



VOREL

No.	Ø (mm)	☐
08520	150	10/100
08521	125	10/100

- PL Tarcza gumowa „multi-dysk” z rzepem
 GB „MULTI-DYISK” rubber disc with velcro
 D Gummihafstüttzsteller
 RUS Насадка резиновая поворотная с липучкой, для дрели
- CZ Terč multi-dysk ze zipem
 RO Suport disc abraziv, fixare scai
 H Multidisc tárcsa tapadókorong
 E Multi-disco con velcro



**PRO
FIL**

No.	Ø (mm)	min-1	☐
08350	125	2000	20

- PL Euro dysk do kątowniki z rzepem
 GB Rubber disc for angle grinder with velcro
 D Klett - Hafstüttzsteller mit Gewindeflansch
 RUS Насадка пластиковая жесткая под круг на липучке
- CZ Euro disk do úhelníků ze zipem
 RO Euro disc cu scai pt. polizor unghiular
 H Euro lemez élhez, tapadókoronggal
 E Disco de goma para ancul con velcro



**PRO
FIL**

No.	Ø (mm)	min-1	☐
08500	125	10000	20
08510	150	8500	20

- PL Tarcza do kątowniki z rzepem nr 2
 GB Rubber disc for angle grinder with velcro
 D Klett - Gummihafstüttzsteller mit Gewindeflansch
 RUS Насадка шлифовальная под круг на липучке
 CZ Kotouč do úhelníků ze zipem číslo 2
 RO Disc de pásă cu scai nr. 2 pt. polizor unghiular
 H Euro lemez élhez, tapadókoronggal, 2 sz.
 E Disco de goma para ancul con velcro



**PRO
FIL**

No.	Ø (mm)	min-1	☐
08511	125	10000	20

- PL Filc polerski na rzep
 GB Polishing felt disc
 D Filzpolierdisc
 RUS Полировальная насадка из фетра на липучке
- CZ Leštiaci plstěnc na zip
 RO Disc pasla de lustruit cu scai
 H Polirozó filc tapadókoronggal
 E Fieltro de pulir con velcro



**PRO
FIL**

No.	Ø (mm)	min-1	☐
08522	125	10000	100

PL Nóż składany CZ Kapesni nůž
 GB Folding utility knife RO Briceag
 D Klappmesser H Zsebkés
 RUS Нож складной E Navaja



No.	mm	Box icon
76526	61x33x0.5	12/72

PL Nóż składany sierpak CZ Montážní nůž
 GB Electrician's knife RO Cutit pt. decablat
 D Montagmesser H Szerelőkés
 RUS Нож складной E Cuchillo de montaje



No.	blade / ostrze (mm)	Box icon
76622	85	10/100

PL Nóż monterski CZ Montážní nůž
 GB Cable knife RO Cutit pt. decablat
 D Montagmesser H Szerelőkés
 RUS Нож электрика E Cuchillo de montaje



No.	type	Box icon
76650	K-508	50

PL Nóż uniwersalny CZ Univerzální nůž
 GB Utility knife RO Cutter metallic
 D Universalmesser H Univerzálnis kés
 RUS Нож универсальный, лезвие трапеция, металлический корпус E Cutter universal

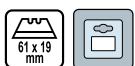

No.	blade / ostrze (mm)	Box icon
76000	61x19	25/200

PL Nóż składany sierpak CZ Dřevěný nůž srpek
 GB Lock knife RO Cutit secera maner lemn
 D Klappmesser H Hajlított pengéjű kés, fanyelű
 RUS Нож складной E Cuchillo falciforme de madera

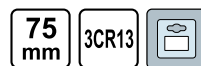

No.	blade / ostrze (mm)	Box icon
76621	75	10/100

PL Nóż monterski CZ Montážní nůž
 GB Cable knife RO Cutit pt. decablat
 D Montagmesser H Szerelőkés
 RUS Нож электрика E Cuchillo de montaje



No.	type	Box icon
76640	K-506	50

PL Nóż sierpak CZ Dřevěný nůž srpek
 GB Cable knife RO Cutit secera maner lemn
 D Klappmesser H Hajlított pengéjű kés, fanyelű
 RUS Нож садовый E Cuchillo falciforme de madera



No.	type	Box icon
76660	K-394	50

PL Ostrza zapasowe do 76000 CZ Lomené ostří náhradní
 GB Spare blades for 76000 RO Lame rezerva pt. cutter metallic
 D Ersatz-Kurzklingen 5TLG. /für 76000/ H Törhető tartalékpenge
 RUS Запасные лезвия для ножа 76000 E Filos de recambio para cutter univers.



No.	blade / ostrze (mm)	for / dla	Box icon
76010	61x19	76000, 76011, 76015	100/600

PL Nóż instalacyjny z magazynkiem
 GB Cutting knife with blade compartment
 D Universalmesser
 RUS Нож обрешитный

CZ Univerzální nůž
 RO Cutter cu maner metalic si compartiment pt. rezerve
 H Univerzális kés
 E Cutter con cargador

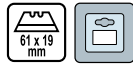

No.	blade / ostrze (mm)	
76011	61x19	12/72

PL Nożyk z ostrzem lamany
 GB Metal utility knife
 D Messer mit Abbrechklingen
 RUS Нож пистолетный

CZ Univerzální nůž
 RO Cutter universal
 H Univerzális kés
 E Cuchill con filo partido



No.	blade / ostrze (mm)	
76101	9	60/360

PL Nożyk z ostrzem lamany
 GB Metal utility knife
 D Messer mit Abbrechklingen
 RUS Нож пистолетный

CZ Univerzální nůž
 RO Cutter universal
 H Univerzális kés
 E Cuchill con filo partido



No.	blade / ostrze (mm)	
76184	18	12/120

PL Nożyk z ostrzem lamany
 GB Metal utility knife
 D Messer mit Abbrechklingen
 RUS Нож пистолетный

CZ Univerzální nůž
 RO Cutter universal
 H Univerzális kés
 E Cuchill con filo partido



No.	blade / ostrze (mm)	
76185	18	60/600

PL Nożyk z ostrzem trapezowym
 GB Utility knife
 D Universalmesser
 RUS Нож универсальный

CZ Univerzální nůž
 RO Cutter universal
 H Univerzális kés
 E Cutter con filo trapezoidal

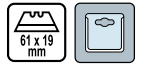

No.	blade / ostrze (mm)	
76015	61x19	12/72

PL Nożyk z ostrzem lamany
 GB Metal utility knife
 D Messer mit Abbrechklingen
 RUS Нож пистолетный

CZ Univerzální nůž
 RO Cutter universal
 H Univerzális kés
 E Cuchill con filo partido



No.	blade / ostrze (mm)	
76160	9	24/288

PL Nożyk z ostrzem lamany
 GB Metal utility knife
 D Messer mit Abbrechklingen
 RUS Нож пистолетный

CZ Univerzální nůž
 RO Cutter universal
 H Univerzális kés
 E Cuchill con filo partido

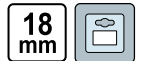

No.	blade / ostrze (mm)	
76180	18	40/400

PL Nożyk z ostrzem lamany
 GB Metal utility knife
 D Messer mit Abbrechklingen
 RUS Нож пистолетный

CZ Univerzální nůž
 RO Cutter universal
 H Univerzális kés
 E Cuchill con filo partido



No.	blade / ostrze (mm)	
76181	18	50/400

PL Nożyk z ostrzem lamany
GB Metal utility knife
D Messer mit Abbrechklingen
RUS Нож пистолетный

CZ Univerzální nůž
RO Cutter universal
H Univerzális kés
E Cuchill con filo partido



No.	blade / ostrze (mm)	Box icon
76182	18	24/240

PL Nożyk z ostrzem lamany
GB Metal utility knife
D Messer mit Abbrechklingen
RUS Нож пистолетный

CZ Univerzální nůž
RO Cutter universal
H Univerzális kés
E Cuchill con filo partido



No.	blade / ostrze (mm)	Box icon
76186	18	12/144

PL Ostrza zapasowe do nożyka
GB Spare blades
D Abbrechklingen
RUS Запасные лезвия

CZ Lomené ostří náhradní
RO Lame de rezerva pt. cutter
H Törhető tartalékpenge
E Filo partido de recambio



No.	W (mm)	pcs	Box icon
76214	25	5	36/288

No.	W (mm)	pcs	Box icon
76210	9	5	100/600
76220	18	5	100/600

PL Komplet nożyków
GB All purpose knife set
D Messersatz
RUS Набор ножей и скребков

CZ Nůže na tapety
RO Set cuttere
H Tapétaolló
E Juego de cuchillos



No.	pcs	Box icon
76250	5	30/150

PL Nożyk z ostrzem lamany
GB Metal utility knife
D Messer mit Abbrechklingen
RUS Нож пистолетный

CZ Univerzální nůž
RO Cutter universal
H Univerzális kés
E Cuchill con filo partido

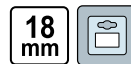

No.	blade / ostrze (mm)	Box icon
76183	18	24/144

PL Nożyk z ostrzem lamany
GB Metal utility knife
D Messer mit Abbrechklingen
RUS Нож пистолетный

CZ Univerzální nůž
RO Cutter universal
H Univerzális kés
E Cuchill con filo partido



No.	blade / ostrze (mm)	Box icon
76190	25	12/72

PL Komplet nożyków
GB Utility knife set
D Universalmessersatz
RUS Ножи пистолетные

CZ Nůže na tapety
RO Set cuttere
H Tapétaolló
E Cuchill con filo partido



No.	pcs	Box icon
76230	3	50/200

PL Komplet nożyków
GB All purpose knife set
D Messersatz
RUS Набор ножей и скребков

CZ Nůže na tapety
RO Set cuttere
H Tapétaolló
E Juego de cuchillos



No.	pcs	Box icon
76280	8	25/100

PL Skrobak do szyb CZ Škrabák na skla
 GB Window scraper RO Răzuitor pt. geamuri
 D Glasschaber H Kaparó üveghez
 RUS Скребок для краски E Rascador de vidrio



No.	blade / ostrze (mm)	
06820	60	50/200

PL Nóż olejowy do szkła CZ Nůž olejový do skla
 GB Oil glass cutter RO Diamant pt. sticlă
 D Ölglasschneider H Olajkés üveghez
 RUS Стеклопёрез масляный E Cuchillo de aceite para cristal



No.		
05850		6/120

PL Punktak automatyczny CZ Automatické důlčikem
 GB Automatic center punch RO Automat centru de pumn
 D Automatischer Körner Einstellbare H Automatikus központ punci
 RUS Автоматический кернер E Sacador de centro automático



No.	L (mm)	
35240	140	12/72

PL Komplet nożyków precyzyjnych z ostrzami CZ Sada přesných nožů s břity
 GB Wood carving knife set RO Set cutite prelucrare lemn
 D Präzisionsmessersatz H Modellező készlet pengékkel
 RUS Набор ножей для резбы по дереву E Juego de cutters precisos con cuchillos



No.	pcs	
76305	16	25/100

PL Nóż do szkła CZ Nůž do skla
 GB Glass cutter RO Diamant pt. sticlă
 D Glasschneider H Kés üveghez
 RUS Стеклопёрез E Cuchillo para cristal



No.		
05100		12/240

PL Rysik traserski CZ Rysovací jehla
 GB Scriber RO Ac detrasat
 D Reißnadel H Karctu
 RUS Чертилка по металлу E Trazador



No.	L (mm)	
35210	140	12/72

PL Cyklina ręczna, drewniana CZ Dřevěná hoblarka ruční
 GB Double edge scraper RO Rascheta dubla (maner lemn)
 D Schaber H Kézi, fa simító
 RUS Циклевка с деревянной ручкой E Rascador manual de madera



No.	mm	
06840	40	10
06860	60	10

PL Nożyczki CZ Nůžky
 GB Scissors RO Foarfece
 D Haushaltsschere H Olló
 RUS Ножницы E Tijeras



No.	L (mm)	
76311	170	12/144

PL Nożyczki
GB Scissors
D Haushaltsschere
RUS Ножницы

CZ Nůžky
RO Foarfece
H Olló
E Tijeras



No.	L (mm)	Box
76312	220	12/144

PL Dziurkacz nastawny
GB Leather hole punch
D Einstellbarer Locher
RUS Дырокол pistolетный

CZ Děrovací kleště nastavitelné
RO Perforator ajustabil
H Állítható lyukasztó
E Pinza perforadora ajustable

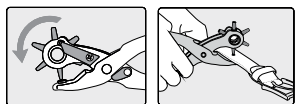

No.	L (mm)	Box
43600	220	6/36

PL Praska do zaciskania nap
GB Pliers for plastic snaps
D Zange für Plastic Moschettoni
RUS Клещи для пластиковых защелками

CZ Pliers pro plastovú nezapadne
RO Plastic pliers pt. sporturi
H Fogó műanyag pattan
E Alicates para la snaps de plástico



No.	Ø (mm)	Box
76710	10; 12; 14	30/60

PL Komplet przebijaków do skóry
GB Punch set
D Lederlocherstet
RUS Набор пробойников для кожи

CZ Sada průbojníků na kůži
RO Set preducele
H Bőryukasztó készlet
E Juego de perforar en piel



No.	Ø (mm)	Box
76700	2; 2.5; 3.2; 4; 4.8; 5.5; 6.4; 8; 9.5; 11.1; 12.7; 14; 15.8; 19; 22	5/20

PL Komplet nożyczek
GB Scissors set
D Haushaltsscherensatz
RUS Ножницы бытовые в наборе

CZ Univerzální nůžky
RO Foarfece universale
H Univerzális olló
E Tijeras universales



No.	L (mm)	pcs	Box
76314	140; 170; 190; 220; 250	5	12/24

PL Zestaw kaletniczy
GB Leather hole punch & grommet setting tool kit
D Taschner Satz
RUS Набор для установки кнопок и люверсов

CZ Děrovačka na pásky
RO Set clesti prelucrare piele
H Szegecselő és lyukasztó készlet
E Kit de cuero herramientas neumáticas de perforación y ojal

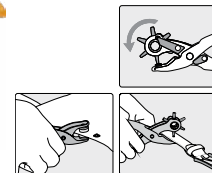
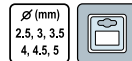
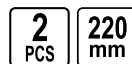

No.	Box
43603	5/20

PL Komplet przebijaków do skóry
GB Punch set
D Lederlocherstet
RUS Набор пробойников для кожи

CZ Sada průbojníků na kůži
RO Set preducele
H Bőryukasztó készlet
E Juego de perforar en piel



No.	Ø (mm)	Box
76705	2.5; 3; 4; 5; 6; 7; 8; 9; 10	10/80

PL Strug kątnik, czolowy
GB Rabbet plane
D Simshobel
RUS Фальцгебель двойной деревянный

CZ Hoblík čelní drážkovník
RO Rindea frontală unghiulară
H Párkánygyalu, homlok
E Cepillo de ranura



No.	mm	Box
25830	245x30	20

PL Strug drewniany CZ Dřevěný hoblík
 GB Wood plane RO Rindea de lemn
 D Putzhobel H Fagyalu
 RUS Рубанок отборник деревянный E Cepillo de madera

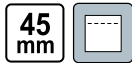

No.	blade width / szerokość ostrza (mm)	type	box icon
25860	45	fine / gladzik	30

PL Pilnik do metalu CZ Pilnik na kov
 GB Steel file RO Pila otel
 D Werkstattfeile H Fémreszelő
 RUS Напильник слесарный E Lima de metalo



No.	L (mm)	box icon
25161	200	20/100

PL Pilnik do metalu CZ Pilnik na kov
 GB Steel file RO Pila otel
 D Werkstattfeile H Fémreszelő
 RUS Напильник слесарный E Lima de metalo



No.	L (mm)	box icon
25163	200	20/100

PL Komplet pilników do metalu CZ Sada pilníků na kov
 GB Steel file set RO Set pile otel
 D Werkstattfeilensatz H Fémreszelő készlet
 RUS Напильники слесарные E Juego de limas para metalo

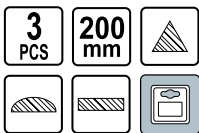

No.	L (mm)	pcs	box icon
25165	200	3	10/20

PL Pilnik do metalu CZ Pilnik na kov
 GB Steel file RO Pila otel
 D Werkstattfeile H Fémreszelő
 RUS Напильник слесарный E Lima de metalo



No.	L (mm)	box icon
25160	200	20/100

PL Pilnik do metalu CZ Pilnik na kov
 GB Steel file RO Pila otel
 D Werkstattfeile H Fémreszelő
 RUS Напильник слесарный E Lima de metalo



No.	L (mm)	box icon
25162	200	20/100

PL Pilnik do metalu CZ Pilnik na kov
 GB Steel file RO Pila otel
 D Werkstattfeile H Fémreszelő
 RUS Напильник слесарный E Lima de metalo



No.	L (mm)	box icon
25164	200	25/100

PL Komplet pilników do metalu CZ Sada pilníků na kov
 GB Steel file set RO Set pile otel
 D Werkstattfeilensatz H Fémreszelő készlet
 RUS Напильники слесарные E Juego de limas para metalo

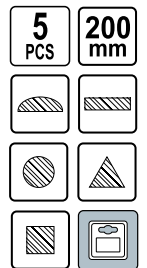

No.	L (mm)	pcs	box icon
25166	200	5	10/20

- PL Zestaw pilników do metalu „igłaki” CZ Pilniki na kov jehlové
 GB Needle file set RO Set de pile lemn - metal
 D Schlüsselfeileinsatz H Tűreszelő készlet fémhez
 RUS Набор напильей E Limas de metalu agujas



No.	L (mm)	pcs	packing	
25370	4x150	5		20/200
25380	4x150	10		25/100
25390	4x150	12		25/100

- PL Zestaw pilników do metalu „igłaki” CZ Pilniki na kov jehlové
 GB Needle file set RO Set de pile lemn - metal
 D Schlüsselfeileinsatz H Tűreszelő készlet fémhez
 RUS Набор напильей E Limas de metalu agujas

6
PCS



VOREL

No.	L (mm)	pcs	
25351	140	6	20/160
25352	160	6	20/160
25353	180	6	20/120

- PL Oselka diamentowa CZ Diamond brousek
 GB Diamond whetstone RO Piatra abraziva diamantata
 D Diamant Schleifstein H Kétoldalas gyémánt fenékö
 RUS Алмазный брусок E Piedra de afilar diamantada

400
GRIT / ZIARNO

150x50
mm

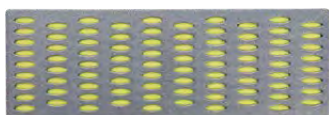

VOREL

No.	type	mm	
26131	P400	150x50	20/100

- PL Zestaw osek diamentowych CZ Diamond brousek
 GB Diamond whetstone RO Piatra abraziva diamantata
 D Diamant Schleifstein H Kétoldalas gyémánt fenékö
 RUS Алмазный брусок E Piedra de afilar diamantada

3
PCS

75x25
mm

180
260
360
GRIT / ZIARNO



VOREL

No.	type	mm	
26140	P180; P260; P360	75x25	25/100

- PL Zestaw pilników do metalu „igłaki” CZ Pilniki na kov jehlové
 GB Needle file set RO Set de pile lemn - metal
 D Schlüsselfeileinsatz H Tűreszelő készlet fémhez
 RUS Набор напильей E Limas de metalu agujas

6
PCS



No.	pcs	
25360	6	20/200

- PL Oselka diamentowa CZ Diamond brousek
 GB Diamond whetstone RO Piatra abraziva diamantata
 D Diamant Schleifstein H Kétoldalas gyémánt fenékö
 RUS Алмазный брусок E Piedra de afilar diamantada

600
GRIT / ZIARNO

150x50
mm

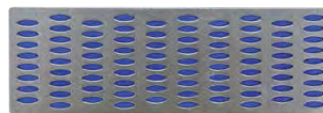

VOREL

No.	type	mm	
26130	P600	150x50	20/100

- PL Oselka diamentowa CZ Diamond brousek
 GB Diamond whetstone RO Piatra abraziva diamantata
 D Diamant Schleifstein H Kétoldalas gyémánt fenékö
 RUS Алмазный брусок E Piedra de afilar diamantada

300
GRIT / ZIARNO

150x50
mm

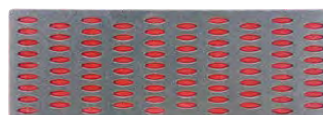

VOREL

No.	type	mm	
26132	P300	150x50	20/100

- PL Tarnik do drewna CZ Raşle do dfeva
 GB Wood rasp RO Pile pt. lemn
 D Holzraspel H Fareszelő
 RUS Рашиль E Escarpelo para madera

200
mm



VOREL

No.	L (mm)	
25170	200	25/100

PL Tarnik do drewna CZ Raşple do dřevo
 GB Wood rasp RO Pile pt. lemn
 D Holzraspel H Fareszelő
 RUS Рашиль E Escarpelo para madera



No.	L (mm)	
25171	200	25/100

PL Komplet tarników do drewna CZ Raşple do dřevo
 GB Wood rasp set RO Set pile pt. lemn
 D Holzraspelsatz H Fareszely készlet
 RUS Набор рашпелей E Juego de escarpelos para madera



No.	L (mm)	pcs	
25173	200	3	10/20

PL Tarnik do gipsu CZ Raşple pro omítky
 GB Rasp for plaster RO Rasp pt. tencuiala
 D Gipskartonplatten Rasp H Reszelt vakolat
 RUS Рашиль для гипсокартона E Eliminador de yeso

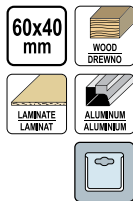

No.	size / rozmiar (mm)	
25300	60x40	10/60

PL Tarnik do gipsu CZ Raşple pro omítky
 GB Rasp for plaster RO Rasp pt. tencuiala
 D Gipskartonplatten Rasp H Reszelt vakolat
 RUS Рашиль для гипсокартона E Eliminador de yeso

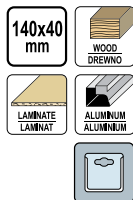

No.	size / rozmiar (mm)	
25307	140x40	15/60

PL Tarnik do drewna CZ Raşple do dřevo
 GB Wood rasp RO Pile pt. lemn
 D Holzraspel H Fareszelő
 RUS Рашиль E Escarpelo para madera



No.	L (mm)	
25172	200	25/100

PL Komplet tarników do drewna CZ Raşple do dřevo
 GB Wood rasp set RO Set pile pt. lemn
 D Holzraspelsatz H Fareszely készlet
 RUS Набор рашпелей E Juego de escarpelos para madera



No.	L (mm)	pcs	
25230	200	3	15/60

PL Tarka zapasowa do tarnika CZ Čepel do škrabacích
 GB Blade for rasp RO Lama pt. rasp
 D Sägeblattraspel H Penge reszelő
 RUS Лезвие для рашпиля по гипсокартону E Hoja para raspar



No.	size / rozmiar (mm)	for / dla	
25301	60x40	25300	10/120

PL Tarnik do gipsu CZ Raşple pro omítky
 GB Rasp for plaster RO Rasp pt. tencuiala
 D Gipskartonplatten Rasp H Reszelt vakolat
 RUS Рашиль для гипсокартона E Eliminador de yeso



No.	size / rozmiar (mm)	
07930	140x50	6/36

- PL Tarnik do gipsu
GB Rasp for plaster
D Gipskartonplatten Rasp
RUS Рашиль для гипсокартона
- CZ Rašple pro omítky
RO Rasp pt. tencuiala
H Reszelt vakolat
E Eliminador de yeso

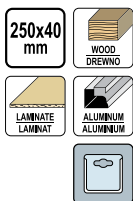

No.	size / rozmiar (mm)	
25310	250x40	15/60

- PL Oselka owalna
GB Sharpening stone
D Abziehstein
RUS Брусок
- CZ Obtahovací brousek
RO Pila abraziva pt. ascutit
H Fenőkő
E Piedra de afilar



No.	L (mm)	
26210	225	50/100

- PL Ostrzarka do wiertarki
GB Rotary sharpener
D Bohrschärfer-Bohrmaschinenaufsatz
RUS Точило для ножей и ножиц
- CZ Brousek na nože a nůžky
RO Rezerva pt dispozitiv de ascutit burghie
H Élezőkő fűrőgéphe fogható
E Muela afilar cuchillos y tijeras

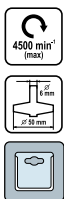

No.		
26225		80/240

- PL Papier ścierny wodoodporny
GB Waterproof sand paper
D Schleifpapier wasserfest
RUS Бумага наждачная-водостойкая
- CZ Smirkový papír vodní
RO Hartie abraziva rezistentă la apa
H Csiszolópapír vizes
E Papel de lija resistente al agua



- PL Oselka
GB Sharpening stone
D Abziehstein
RUS Брусок
- CZ Obtahovací brousek
RO Pila abraziva pt. ascutit
H Fenőkő
E Piedra de afilar



No.	L (mm)	
26150	150	25/50
26200	200	25/50

- PL Ostrzarka do noży
GB Knife sharpener
D Messerschärfer
RUS Точилка для ножей
- CZ Brousek na nože
RO Cutit ascutitoare
H Késélező
E Afilador de cuchillos



No.		
26220		12/96

- PL Papier ścierny wodoodporny
GB Waterproof sand paper
D Schleifpapier wasserfest
RUS Бумага наждачная-водостойкая
- CZ Smirkový papír vodní
RO Hartie abraziva rezistentă la apa
H Csiszolópapír vizes
E Papel de lija resistente al agua



No.	mm	pcs	
07650	230x280	15	80

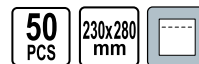

No.	type	mm	pcs	
07060	P60	230x280	50	1000
07080	P80	230x280	50	1000
07100	P100	230x280	50	1000
07120	P120	230x280	50	1000
07180	P180	230x280	50	1000
07240	P240	230x280	50	1000
07320	P320	230x280	50	1000
07400	P400	230x280	50	1000
07506	P600	230x280	50	1000
07508	P800	230x280	50	1000
07510	P1000	230x280	50	1000
07512	P1200	230x280	50	1000

PL Plótno ścieme CZ Brusné platno
GB Abrasive cloth RO Pânză abrazivă
D Schleifgewebe H Csiszolóvászon
RUS Бумага наждачная на тканевой основе E Paño abrasivo

50 PCS 230x280 mm



No.	type	mm	pcs	
07530	P36	230x280	50	500
07540	P46	230x280	50	500
07560	P60	230x280	50	500
07580	P80	230x280	50	500
07610	P100	230x280	50	500
07620	P120	230x280	50	500
07630	P150	230x280	50	500

PL Taśma ścierna bezkońcowa CZ Pás brusný nekonečný
GB No end abrasive band RO Banda abraziva
D Schleifband H Végtelenített csiszolószalag
RUS Лента шлифовальная бесконечная E Banda abrasiva sin extremos

5 PCS 75x533 mm



No.	type	mm	pcs	
07664	P40	75x533	5	20/60
07665	P60	75x533	5	20/60
07666	P80	75x533	5	20/60
07667	P100	75x533	5	20/60
07668	P120	75x533	5	20/60

PL Gąbka ścierna CZ Hubka brusná
GB Abrasive sponge RO Burete abraziv
D Schleifschwamm H Dörzsszivacs
RUS Шлифовальная сетка E Esponja abrasiva

124x98x12 mm ALOXITE COATING NASYP ELEKTROKORUND



No.	type	mm	
07910	P46	124x98x12	100
07911	P60	124x98x12	100
07912	P80	124x98x12	100
07913	P100	124x98x12	100
07914	P120	124x98x12	100
07915	P150	124x98x12	100
07916	P180	124x98x12	100

PL Siatka ścierna CZ Brusné pletivo
GB Abrasive mesh RO Plasă abrazivă
D Schleifgitter H Csiszolóháló
RUS Шлифовальная сетка E Red abrasiva nacional

105x280 mm



No.	type	mm	
07879	P40	105x280	50
07880	P60	105x280	50
07881	P80	105x280	50
07882	P100	105x280	50
07883	P120	105x280	50
07884	P150	105x280	50
07885	P180	105x280	50
07886	P220	105x280	50

PL Kostka ścierna CZ Hubka brusná
GB Abrasive sponge RO Burete abraziv
D Schleifschwamm H Dörzsszivacs
RUS Губка для шлифования E Esponja abrasiva

68x100x25 mm ALOXITE COATING NASYP ELEKTROKORUND



No.	type	mm	
08288	P60	68x100x25	100
08289	P80	68x100x25	50
08290	P100	68x100x25	50
08291	P120	68x100x25	50
08292	P150	68x100x25	50
08293	P180	68x100x25	50

PL Kostka ścierna CZ Hubka brusná
GB Abrasive sponge RO Burete abraziv
D Schleifschwamm H Dörzsszivacs
RUS Шлифовальная сетка E Esponja abrasiva

125x90x65x25 mm ALOXITE COATING NASYP ELEKTROKORUND

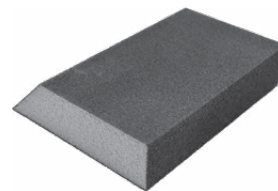

No.	type	mm	
08301	P60	125x90x65x25	100
08302	P80	125x90x65x25	100
08303	P100	125x90x65x25	100
08304	P120	125x90x65x25	100
08306	P150	125x90x65x25	100
08307	P180	125x90x65x25	100
08308	P220	125x90x65x25	100

PL Kostka ścierna CZ Hubka brusná
 GB Abrasive sponge RO Bureta abraziv
 D Schleifschwamm H Dörzsszivacs
 RUS Шлифовальная сетка E Esponja abrasiva



111 x 73 x 25 mm
 ALOXITE COATING
 NASYP
 ELEKTROKORUND



No.	type	mm	
08271	P60	111x73x25	100
08272	P80	111x73x25	100
08273	P100	111x73x25	100
08274	P120	111x73x25	100
08275	P150	111x73x25	100
08276	P180	111x73x25	100
08277	P220	111x73x25	100

PL Krążek ścierny z otworami
 GB Abrasive disc with holes with velcro
 D Fiberschleifscheiben gelocht
 RUS Круг шлифовальный перфорированный для липучки
 CZ Brusný kotouč z otvorami
 RO Disc abraziv cu orificii
 H Csiszolótárcsa /tapadókoronggal/
 E Juego de discos abrasivos con agujeros

5 PCS
 125 Ømm
 HOOK FASTENER
 Z RZEPREM

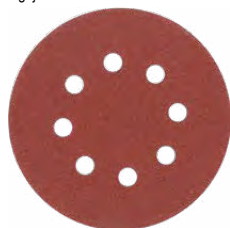

No.	type	Ø (mm)	pcs	
08573	P36	125	5	50/200
08574	P40	125	5	50/200
08576	P60	125	5	50/200
08578	P80	125	5	50/200
08580	P100	125	5	50/200
08582	P120	125	5	50/200
08585	P150	125	5	50/200

PL Blok ścierny CZ Brusný blok
 GB Sanding block RO Suport smirghel
 D Handschleifer H Csiszolóblokk
 RUS Брусок для шлифования E Bloque abrasivo



No.	mm	
07950	85x160	20/100
07970	100x210	20/80

PL Krążek ścierny z rzepem CZ Brusný kotouč /zip/
 GB Abrasive disc with velcro RO Disc abraziv (scali)
 D Fiberschleifscheiben ungelocht H Csiszolótárcsa /tapadókoronggal/
 RUS Круг шлифовальный на липучке E Juego de discos abrasivos /velcro/

5 PCS
 125 Ømm
 HOOK FASTENER
 Z RZEPREM



No.	type	Ø (mm)	pcs	
08553	P36	125	5	50/200
08554	P40	125	5	50/200
08556	P60	125	5	50/200
08558	P80	125	5	50/200
08560	P100	125	5	50/200
08562	P120	125	5	50/200
08565	P150	125	5	50/200

PL Arkusze ścierny z otworami
 GB Abrasive sheets with holes
 D Schleifbogen gelocht
 RUS Шлифовальная бумага перфорированная
 CZ Brusné archy /z otvorami/
 RO Hartie abraziva cu orificii
 H Csiszolóív /lyukakkal/
 E Ojas abrasivas /con agujer/

5 PCS
 93x240 mm



No.	type	mm	pcs	
08534	P40	93x240	5	50/200
08536	P60	93x240	5	50/200
08538	P80	93x240	5	50/200
08540	P100	93x240	5	50/200
08542	P120	93x240	5	50/200
08545	P150	93x240	5	50/200

PL Blok ścierny skręcany CZ Brusný blok
 GB Sanding block RO Suport smirghel
 D Handschleifer H Csiszolóblokk
 RUS Тёрка для шлифования E Bloque abrasivo

220x100 mm



No.	mm	
07960	220x100	30

PL Blok ściemy zatrask
 GB Sanding block
 D Handschleifer
 RUS Тёрка для шлифования

CZ Brusný blok
 RO Suport smirghel
 H Csiszolóblokk
 E Bloque abrasivo



No.	mm	
07962	210x100	30

PL Zestaw polerski
 GB Polishing set
 D Polieret
 RUS Полировальный набор

CZ Čistící a lešticí souprava
 RO Set pt. lustruit
 H Tisztító és polírozó készlet
 E Conjunto de limpeza e polimento

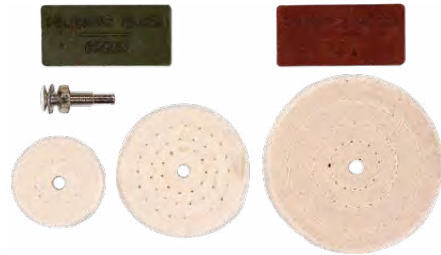
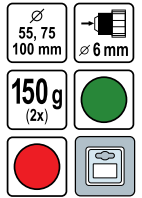

No.	
25420	30/60

Memo



9

Plumbing tools
Narzędzia hydrauliczne



Ratchet die stocks
Komplety gwintownic ręcznych

122

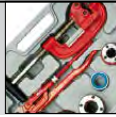

Hinged pipe vices
Imadła zaciskowe do rur

122



Water pump pliers
Szczypce nastawne

122



Pipe wrenches
Klucze do rur

122-123



Pipe wrenches Stillson type
Klucze do rur typu Stillson.....

122

Adjustable pipe wrenches
Klucze do rur nastawne.....

123

Adjustable wrenches
Klucze nastawne francuskie.....

123

Chain pipe wrenches
Klucze do rur łańcuchowe

123



Pipe cutters
Obcinaki do rur

124



Calibrators
Kalibratory

124



Pipe welders
Zgrzewarki do rur

124-125



Burners & soldering tools
Palniki i lutownice

125-126



Hydraulic accessories
Akcesoria hydrauliczne

126-127



- PL Zestaw narzędzi hydraulicznych
 GB Plumbing tool set
 D Hydraulischer Werkzeugkasten
 RUS Набор сантехнического инструмента
- CZ Soustava hydraulických nářadí
 RO Trusa instalator pt. tevi
 H Csőszereelő szerszámkészlet
 E Juego de herramientas de fontanero

12
PCS



No.	size / rozmiar	pcs	
55800	1/4" (6.3 mm); 3/8" (10.0 mm); 1/2" (12.5 mm); 3/4" (19.0 mm); 1" (25.0 mm); 5/4" (32.0 mm)	12	2

9

- PL Zestaw gwintownic
 GB Ratchet die stock
 D Schneidkluppensatz
 RUS Набор резьбонарезной сантехнический
- CZ Sada závitníků
 RO Set de filiere
 H Menetfúró készlet
 E Juego de rosacar

6
PCS



No.	size / rozmiar	pcs	
55830	1-1/2" (38 mm); 2" (50 mm)	6	2

- PL Szczypce hydrauliczne nastawne
 GB Water pump pliers
 D Wasserpumpenzange
 RUS Клещи переставные
- CZ Keleště siko
 RO Clește papagal
 H Vízpumpafágó
 E Alicates de fontanero ajustables

250
mm



7
POSITIONS
POZYCJI



No.	L (mm)	
41510	250	10/50

- PL Zestaw gwintownic
 GB Ratchet die stock
 D Schneidkluppensatz
 RUS Набор резьбонарезной сантехнический
- CZ Sada závitníků
 RO Set de filiere
 H Menetfúró készlet
 E Juego de rosacar

7
PCS



No.	size / rozmiar	pcs	
55820	3/8" (10.0 mm); 1/2" (12.5 mm); 3/4" (19.0 mm); 1" (25.0 mm); 5/4" (32.0 mm)	7	4

- PL Imadło zaciskowe do rur
 GB Hinged pipe vice
 D Rohrschraubstock
 RUS Тиски для труб
- CZ Upínací svěrák na trubky
 RO Menghină pt. țevi
 H Satu, csőszorító
 E Tornillo de apriete para tubos

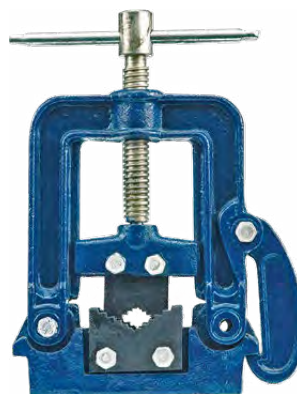

No.	mm	
36570	13-50	6

- PL Klucz do rur
 GB Pipe wrench
 D Rohrschlüssel
 RUS Ключ трубный
- CZ Klíč součásti na trubky
 RO Cheie reglabila pt. țevi
 H Csőkulcs
 E Llave de fontanero

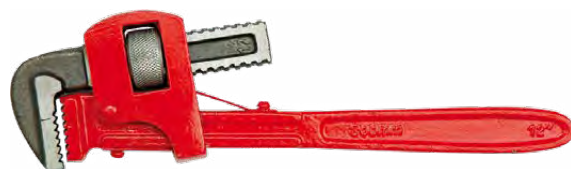

No.	L (mm)	
55250	250	6/48
55300	300	6/36
55350	350	6/24

PL Klucz do rur
GB Pipe wrench
D Rohrschlüssel
RUS Ключ трубный

CZ Klíč součásti na trubky
RO Cheie pt. țevi
H Csőkulcs
E Llave de fontanero



No.	L (mm)	
55620	195	6/36
55625	245	6/30
55630	275	6/24
55635	310	6/18
55645	395	4/12
55660	490	2/6
55690	750	2/4

PL Klucz nastawny do rur
GB Adjustable pipe wrench
D Rohrschlüssel
RUS Ключ трубный

CZ Nastavitelný klíč na trubky
RO Cheie reglabilă pt. țevi
H Állítható csőkulcs
E Llave de vaso para tubería



No.	size / rozmiar	
55210	1.0" (25 mm)	24
55211	1.5" (38 mm)	16
55212	2.0" (50 mm)	8

PL Klucz nastawny francuski
GB Adjustable wrench
D Stahlschraubenschlüssel /franzose/
RUS Ключ разводной

CZ Nastavitelný klíč francouz
RO Cheie reglabilă franceză
H Állítható franciakulcs
E Llave ajustable inglesa



No.	KNF	jaws range / zakres szczęk (mm)	jaws width / szerokość szczęk (mm)	
54497	25	0-25	60	10
54498	35	0-55	70	10
54499	45	0-45	80	10
54500	55	0-55	90	5
54510	65	0-65	100	5

PL Klucz nastawny do rur
GB Adjustable pipe wrench
D Rohrschlüssel
RUS Ключ трубный

CZ Nastavitelný klíč na trubky
RO Cheie reglabilă pt. țevi
H Állítható csőkulcs
E Llave de vaso para tubería



No.	size / rozmiar	
55100	1.0" (25 mm)	12/36
55150	1.5" (38 mm)	10/20
55200	2.0" (50 mm)	6/12

PL Klucz nastawny do rur
GB Adjustable pipe wrench
D Rohrschlüssel
RUS Ключ трубный

CZ Nastavitelný klíč na trubky
RO Cheie reglabilă pt. țevi
H Állítható csőkulcs
E Llave de vaso para tubería



No.	size / rozmiar	
55215	1.0" (25 mm)	24
55216	1.5" (38 mm)	16
55217	2.0" (50 mm)	8

PL Klucz nastawny do rur
GB Adjustable pipe wrench
D Rohrschlüssel
RUS Ключ трубный

CZ Nastavitelný klíč na trubky
RO Cheie reglabilă pt. țevi
H Állítható csőkulcs
E Llave de vaso para tubería



No.	size / rozmiar	
55220	1.0" (25 mm)	24
55221	1.5" (38 mm)	16
55222	2.0" (50 mm)	8

PL Klucz łańcuchowy do rur
GB Chain pipe wrench
D Kettenrohrzange
RUS Цепной ключ для труб

CZ Klíč řetězový na trubky
RO Cheie reglabilă pt. țevi cu lant
H Láncos csőfogó
E Llave de cadena



No.	L (mm)	max. pipe diameter / max. średnica rury	
55792	300	4" (100 mm)	10/30

PL Obcinak do rur
GB Pipe cutter
D Rohrabscneider
RUS Труборез для труб из цветных металлов

CZ Řezač trubek
RO Clește pt. tăiat tevi
H Csővágó olló csövekhez
E Cortatubos

∅ 1/10"-5/4"
∅ 3-32 mm

PLASTIC
Al, Cu

WITH DEBURRER
Z GRATOWNIKIEM

BEARING STEEL
STAL ŁOŻYSKOWA

SPARE CUTTING WHEEL
ZAPASOWA KŁÓCZKA



No.	∅ mm	
78381	1/10"-5/4" (3-32 mm)	60

9

PL Przecinak do rur PCV
GB PVC pipe cutter
D PVC Rohrabscneider
RUS Труборез для пластиковых труб

CZ Řezač PVC trubek
RO Clește pt. tăiat tevi din PVC
H Csővágó olló PVC csövekhez
E Cortatubos PVC para

∅ max (mm)
42

PVC
PP
PU
PE

STAINLESS
STEEL BLADE
OSTRZE ZE STALI
NIEODRODZAJEJ
8Cr13

HRC
54



No.	max (mm)	
78341	42	12/48

PL Zgrzewarka do rur termoplastycznych
GB PVC plastic pipe welder
D Schweissgerät für thermoplastische Rohre
RUS Аппарат для сварки пластиковых труб

CZ Svářečka na termoplastické trubky
RO Hegesztő berendezés termoplasztikus csövekhez
H Masina de sudat tevi termoplastice
E Maquina de soldar las tubos termoplasticos

230V~
50Hz

800
W

0-300
°C

IPX4

∅ 16, 20, 25
[mm] 32, 40, 50



No.	W	
78911	800	5

PL Gratownik do rur
GB Plastic pipe edging tool
D Aussen- und Innenentgraten Werkzeug
RUS Наружный/внутренний гратосниматель

CZ Odhrotovač kombinovaný vnitřní / vnější
RO Dispozitiv pt. sanften tevi
H Locsolótömlő csatlakozó
E Escariador bilateral de tubos

∅ 6-36
mm



No.	mm	
78385	6-36	25/50

PL Kalibrator do rur
GB Pipe calibration tool
D Kalibrierer für Mehrschichtverbundrohr
RUS Калибратор пластиковый

CZ Kalibrátor na trubky
RO Calibrator teava multistrat
H Ötregtű cső kalibráló
E Calibrador para tubos multicapa

PE-RT
AL
PE-RT

PEX
AL
PEX

∅ 10x16
∅ 12x20
∅ 14x26
mm

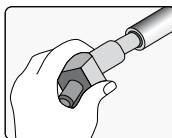

10 mm
12 mm
14 mm
16 mm
20 mm
26 mm

14 mm
16 mm
18 mm
20 mm
25-26 mm
32 mm



No.		
55740		300

PL Zgrzewarka do rur termoplastycznych
GB PVC plastic pipe welder
D Schweissgerät für thermoplastische Rohre
RUS Аппарат для сварки пластиковых труб

CZ Svářečka na termoplastické trubky
RO Hegesztő berendezés termoplasztikus csövekhez
H Masina de sudat tevi termoplastice
E Maquina de soldar las tubos termoplasticos

230V~
50Hz

I-750W
II-1500W

0-300
°C

IPX0

∅ 20, 25, 32
[mm] 40, 50, 63



No.	W	
78912	750-1500	4

- PL Zgrzewarka do rur termoplastycznych
 GB PVC plastic pipe welder
 D Schweissgerät für thermoplastische Rohre
 RUS Сварочная машина для термопластиковых труб
 CZ Svářecíka na termoplastické trubky
 RO Hegeştoó berendezés termoplasztikus csövekhez
 H Masina de sudat tevi termoplastice
 E Máquina de soldar las tubos termoplasticos

230V~ 50Hz	800 W	1500 W
0-300 °C	16, 20, 25, 32 40, 50, 63 [mm]	IP24





STHOR

No.	W	Icon
78910	800-1500	5

- PL Lutownica gazowa 3 w 1
 GB Soldering tool 3 in 1
 D Gaslötkolben 3 in 1
 RUS Газовый паяльник 3-в-1
 CZ Plynová pájka 3 in 1
 RO Ciocan de lipit cu gaz 3 in 1
 H Gaz-forrasztópaka 3 in 1
 E Soldador de gas 3 in 1

15 ml	25~80 W	60 min
BUTANE lighter gas BUTAN (gaz do zapalniczki)	GAS GAZ	PROPANE-BUTANE lighter gas PROPAN-BUTAN (gaz do zapalniczki)



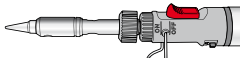

SOLDERING

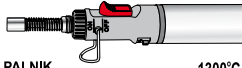

LUTOWANIE 450°C

TORCH



PALNIK 1300°C

HOT SHRINKING

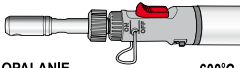

OPALANIE 600°C

VOREL

No.	W	Icon
73410	25 - 80	12/48

- PL Palnik gazowy
 GB Gas blow torch
 D Lötbrenner
 RUS Газовая горелка
- CZ Plynový hořák
 RO Arzator pe gaz
 H Gázégó
 E Soplete de gas

PIEZO	1.3 kW
1300 °C	GAS GAZ
BUTANE BUTAN	Icon of a box



EURO TYPE EN417

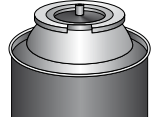

VOREL

No.	kW	Icon
73413	1.3	10/60

- PL Palnik gazowy
 GB Gas blow torch
 D Lötbrenner
 RUS Газовая горелка
- CZ Plynový hořák
 RO Arzator pe gaz
 H Gázégó
 E Soplete de gas

0.22 kW	PIEZO	GAS GAZ	BUTANE lighter gas BUTAN (gaz do zapalniczki)
10 g CAPACITY POJEMNOŚĆ	30 min	LOCK BLOKADA	CHILD PROTECTION ZABEZPIECZENIE PRZED DZIECIAMI



1300°C

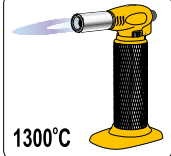

VOREL

No.	kW	Icon
73420	0.22	10/60

- PL Palnik gazowy
 GB Gas blow torch
 D Lötbrenner
 RUS Газовая горелка
- CZ Plynový hořák
 RO Arzator pe gaz
 H Gázégó
 E Soplete de gas

PIEZO	1.3 kW	1300 °C
GAS GAZ	BUTANE BUTAN	Icon of a box



EURO TYPE EN417

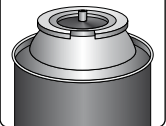

VOREL

No.	kW	Icon
73412	1.3	10/60

- PL Gazowa lampa lutownicza
 GB Gas soldering lamp
 D Gaslötlampe
 RUS Газовая паяльная лампа
- CZ Plynová pájací lampka
 RO Lampă de lipit pe gaz
 H Gázos forrasztólámpa
 E Lampa de gas para soldar

1200°C max.	1.7 kW	123 g/h
CARTRIDGE 190g	BUTAN	COMPOSITE BODY PLASTIKOWY KORPUS



VOREL

No.	kW	Icon
73400	1.7	12

- PL Gazowa lampa lutownicza PIEZO CZ Plynová pájecí lampa
 GB Gas soldering lamp RO Lampă de lipit pe gaz
 D Gaslötlampe H Gázos forrasztólámpa
 RUS Лампа паяльная газовая с пьезоподжигом E Lampa de gas para soldar

PIEZO ELECTRIC 1200°C max. 1.7 kW
 123 g/h CARTRIDGE 190g BUTAN
 METAL COVER METALOWY KORPUS



No.	kW	
73403	1.7	12

- PL Taśma PTFE CZ Teflonová páska
 GB PTFE tape RO Bandă de teflon
 D Teflonband H Teflon szalag
 RUS Фумлента E Cinta de teflón



No.	W (mm)	thickness / grubość (mm)	L (m)	
75200	12	0.075	10	12/2400

- PL Pasta uszczelniająca do gwintów
 GB Thread sealing paste
 D Paste zum Abdichten der Gewinde
 RUS Паста для герметизации резьбы
 CZ Těsnící pasta na závit
 RO Pastă etanșantă pt. filet
 H Menettőmitő paszta
 E Pasta selladora para roscas

FOR WATER / HEATING / GAS / AIR
 DO WODY / C.O. / GAZU / POWIETRZA



No.	g	
86752	360	48

- PL Hydrauliczny zestaw naprawy CZ Hydraulická opravářská souprava
 GB Hydraulic repair kit RO Set de reparatii pt. instalatori
 D Hydraulischer Reparatursatz H Vízvezeték javító készlet
 RUS Комплект для уплотнения резьбы E Juego para reparaciones hidráulicas



No.	g	
86761	100 + 65	40

- PL Gazowa lampa lutownicza PIEZO CZ Plynová pájecí lampa
 GB Gas soldering lamp RO Lampă de lipit pe gaz
 D Gaslötlampe H Gázos forrasztólámpa
 RUS Лампа паяльная газовая с пьезоподжигом E Lampa de gas para soldar

PIEZO 850°C max. 1.7 kW
 123 g/h CARTRIDGE 190g BUTAN
 METAL COVER METALOWY KORPUS



No.	kW	
73404	1.7	12

- PL Taśma PTFE CZ Teflonová páska
 GB PTFE tape RO Bandă de teflon
 D Teflonband H Teflon szalag
 RUS Фумлента E Cinta de teflón



No.	W (mm)	thickness / grubość (mm)	L (m)	
75201	12	0.1	12	250/1000
75202	19	0.2	15	200

- PL Pasta uszczelniająca do gwintów
 GB Thread sealing paste
 D Paste zum Abdichten der Gewinde
 RUS Паста для герметизации резьбы
 CZ Těsnící pasta na závit
 RO Pastă etanșantă pt. filet
 H Menettőmitő paszta
 E Pasta selladora para roscas

FOR WATER / HEATING / GAS / AIR
 DO WODY / C.O. / GAZU / POWIETRZA



No.	g	
86750	65	48
86751	250	48

- PL Pakuty lniane CZ Lněná koudel
 GB Oakum RO Călj de in
 D Leinenwerg H Len kóc
 RUS Лен сантехнический E Estopa de lino



No.	g	
86760	100	50

- PL Pasta poślizgowa do rur PCV
 GB Lubricant for PVC pipes
 D Gleitpaste für PVC-Rohre
 RUS Силиконовая смазка для ПВХ труб
- CZ Kluzná pasta na PVC trubky
 RO Pastă glisantă pt. țevi PVC
 H Sikosító paszta PVC csővekhez
 E Pasta de deslizamiento para tubos de PCV



No.	g	
86770	250	18
86771	500	15

- PL Pompa do udrażniania kanalizacji
 GB Drain suction pump
 D Hochdruck-Rohrreiner
 RUS Пневматический вантуз для прочистки труб
- CZ Čerpadlo na čištění trubek
 RO Pompă pt. curățarea țevelor
 H Csőtisztító szivattyú
 E El desagüe del fregadero limpiador



No.	Ø (mm)	
55505	65; 155	24

- PL Spirala kanalizacyjna
 GB Drain auger
 D Hand-Rohrreinigungsspirale
 RUS Трос сантехнический для чистки труб
- CZ Spirála kanalizační
 RO Dispozitiv de desfundat scurgere
 H Csőtisztító spirál
 E Desatascador espiral

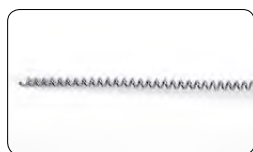

No.	Ø (mm)	L (m)	
55541	5	1.5	20/80
55542	6	3	18/36

- PL Pistolet do udrażniania rur
 GB Drain cleaner
 D Pistole zum Reinigen von Rohren
 RUS Пневматический пистолет для прочистки труб
 CZ Pistole na čištění trubek
 RO Pistol pt. curățarea țevelor
 H Csőtisztító pisztoly
 E Pistola destapacaños



No.	Ø (mm)	
55500	135	10

- PL Przepychacz do udrażniania kanalizacji
 GB Pipe cleaner
 D Räumdorn zum Reinigen der Kanalisation
 RUS Трос сантехнический, щетка-ерш для прочистки труб
 CZ Tlakový čistící kanalizace
 RO Piston pt. deblocarea canalizării
 H Lefolyótisztító pumpa
 E Bomba destapacaños



9



No.	L (cm)	pcs	
55531	65	2	36

- PL Spirala kanalizacyjna
 GB Drain auger
 D Hand-Rohrreinigungsspirale
 RUS Трос сантехнический для чистки труб
- CZ Spirála kanalizační
 RO Dispozitiv de desfundat scurgere
 H Csőtisztító spirál
 E Desatascador espiral



No.	Ø (mm)	L (m)	
55544	9	5	5/10
55545	9	10	4/8

10

Fastening tools Narzędzia do łączenia



Hand riveters
 Nitownice ręczne

130-131

Hand riveters
 Nitownice ręczne..... 130

Hand riveting tool
 Nitownice ręczne, dźwigniowe..... 131

Rivets
 Nity

131

Aluminium blind rivets
 Nity aluminiowe..... 131

Pneumatic riveters
 Nitownice pneumatyczne

132

Profile connection pliers
 Szczypcy do łączenia profili

132

Staple guns, staples & nails
 Zszywacze, zszywki i gwoździe

132-134

Staple guns
 Zszywacze..... 132

Staple removers
 Rozszywacze..... 133

Staples
 Zszywki..... 133

Brad nails
 Szyty..... 134

Nails
 Gwoździe..... 134

Screw, plug & hook sets
 Zestawy wkrętów, kołków i haków

134-136

Caulking guns
 Wyciskacze do mas

136-137

Foam guns
 Pistolety do pianki montażowej

137-138

Hose clips
 Opaski ślimakowe

138-139

Cable ties
 Opaski plastikowe

139-140

Glue sticks & glue applicators
 Wkłady klejowe i dozowniki do kleju

140

Packing tape dispensers
 Podajniki taśmy pakowej

140

Tapes
 Taśmy

140-143

Ropes & lines
 Sznury i linki

143-145



PL Nitownica ręczna
GB Hand riveter
D Blindnietzange
RUS Заклепочник

CZ Ruční nýtovačka
RO Presă de nituit manuală
H Kézi popszegecshúzó
E Remachadora de mano



No.	L (mm)	Ø (mm)	Icon
70000	250	2.4: 3.2: 4.0: 4.8	12/24

PL Nitownica ręczna
GB Hand riveter
D Blindnietzange
RUS Заклепочник

CZ Ruční nýtovačka
RO Presă de nituit manuală
H Kézi popszegecshúzó
E Remachadora de mano



No.	L (mm)	Ø (mm)	Icon
70023	250	2.4: 3.2: 4.0: 4.8	12/24

PL Nitownica ręczna
GB Hand riveter
D Blindnietzange
RUS Заклепочник

CZ Ruční nýtovačka
RO Presă de nituit manuală
H Kézi popszegecshúzó
E Remachadora de mano

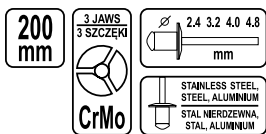

No.	L (mm)	Ø (mm)	Icon
70035	200	2.4: 3.2: 4.0: 4.8	30



PL Nitownica ręczna
GB Hand riveter
D Blindnietzange
RUS Заклепочник

CZ Ruční nýtovačka
RO Presă de nituit manuală
H Kézi popszegecshúzó
E Remachadora de mano



No.	L (mm)	Ø (mm)	Icon
70020	240	2.4: 3.2: 4.0: 4.8	12/24

PL Nitownica ręczna
GB Hand riveter
D Blindnietzange
RUS Заклепочник

CZ Ruční nýtovačka
RO Presă de nituit manuală
H Kézi popszegecshúzó
E Remachadora de mano

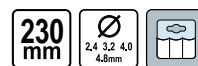

No.	L (mm)	Ø (mm)	Icon
70030	230	2.4: 3.2: 4.0: 4.8	15/30

PL Nitownica ręczna
GB Hand riveter
D Blindnietzange
RUS Заклепочник

CZ Ruční nýtovačka
RO Presă de nituit manuală
H Kézi popszegecshúzó
E Remachadora de mano



No.	L (mm)	Ø (mm)	Icon
70100	280	2.4: 3.2: 4.0: 4.8	12/24

PL Nitownica ręczna CZ Ruční nýtovačka
 GB Hand riveter RO Presă de nituit manuală
 D Blindnietzange H Kézi popszegecshúzó
 RUS Заклепочник E Remachadora de mano



No.	L (mm)	Ø (mm)	Box
70160	250	2.4; 3.2; 4.0; 4.8	12/24

PL Nitownica dźwigniowa CZ Nýtovačka páková
 GB Hand riveting tool RO Pcleşte pt. popnituri
 D Blindnietzange H Emeltyús popszegecshúzó
 RUS Заклепочник E Remachadora de palanca

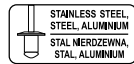
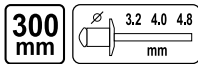

No.	L (mm)	Ø (mm)	Box
70201	300	3.2; 4.0; 4.8	20

PL Nity aluminiowe CZ Hliníkové nýty
 GB Aluminium blind rivets RO Nituri din aluminiu
 D Aluminiumblindnieten H Alu popszegecs
 RUS Заклёпки алюминиевые E Remaches de aluminio

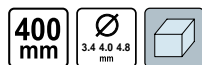

No.	L (mm)	Ø (mm)	Box
70210	400	3.4; 4.0; 4.8	12/24

PL Nitownica ręczna do nitonakrętek CZ Nýtovačka páková
 GB Hand nut tool RO Pcleşte pt. popnituri
 D Blindnietzange H Emeltyús popszegecshúzó
 RUS Заклепочник E Remachadora de palanca



No.	L (mm)	size / rozmiar	Box
70270	265	M3; M4; M5; M6	5/20

PL Nitownica ręczna CZ Ruční nýtovačka
 GB Hand riveter RO Presă de nituit manuală
 D Blindnietzange H Kézi popszegecshúzó
 RUS Заклепочник E Remachadora de mano

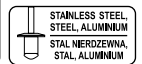

No.	L (mm)	Ø (mm)	Box
70202	310	2.4; 3.2; 4.0; 4.8; 6.4	16

PL Nity aluminiowe CZ Hliníkové nýty
 GB Aluminium blind rivets RO Nituri din aluminiu
 D Aluminiumblindnieten H Alu popszegecs
 RUS Заклёпки алюминиевые E Remaches de aluminio



No.	mm	pcs. packing	Box
70320	6.4x3.2	50	25/250
70330	9.6x3.2	50	25/250
70340	12.7x3.2	50	25/250
70400	6.4x4.0	50	25/200
70410	9.6x4.0	50	25/200
70420	12.7x4.0	50	25/200
70430	19.0x4.0	50	25/200
70480	6.4x4.8	50	25/150
70490	9.6x4.8	50	25/150
70500	12.7x4.8	50	25/150
70510	19.0x4.8	50	25/150

- PL Nitownica pneumatyczna
- GB Pneumatic riveting machine
- D Pneumatische Nietvorrichtung
- RUS Пневматическая клепальная машина
- CZ Pneumatická nýtovačka
- RO Presa pneumatica pt. nituit
- H Pneumatikus popszegecsőző
- E Máquina remachadora

14 mm	85 l/min	720 kg 7060 N
0.63 MPa		



$L_{pa} = 76,1 \pm 3,0$ dB; $L_{pk} = 87,1 \pm 3,0$ dB; $a_n = 0,85 \pm 0,59$ m/s²

No.	Ø (mm)	L (mm)	F (kg)	F (N)	
70280	2.4; 3.2; 4.0; 4.8	14	720	7060	10

- PL Zszywacz tapicerski
- GB Staple gun
- D Tacker
- RUS Степлер мебельный
пластиковый корпус
- CZ Čalounická sešivačka
- RO Capsator tapiterie
- H Kárpitos tűzőgép
- E Grapadora de tapicero

	ABS	
4-8 mm		



No.	mm	
71000	4-8	10/60

- PL Zszywacz tapicerski
- GB Staple gun
- D Tacker
- RUS Степлер металлический
- CZ Čalounická sešivačka
- RO Capsator tapiterie
- H Kárpitos tűzőgép
- E Grapadora de tapicero

4-8 mm	



No.	mm	
71040	4-8	10/40

- PL Szczypce do łączenia profili
- GB Profile connection pliers
- D Zange zum Verbinden der Profile
- RUS Щипцы для соединения профилей
- CZ Kleště ke spojování profilů
- RO Clește pt. îmbinarea profilelor
- H Profilegyesítő fogó
- E Pinzas para conectar perfiles

280 mm	
65 Mn (PUNCH)	

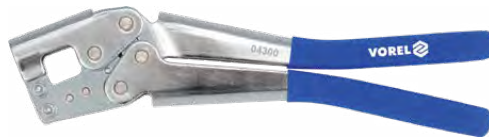

No.	L (mm)	
04300	280	6/36

- PL Szczypce do łączenia profili
- GB Profile connection pliers
- D Zange zum Verbinden der Profile
- RUS Щипцы для соединения профилей
- CZ Kleště ke spojování profilů
- RO Clește pt. îmbinarea profilelor
- H Profilegyesítő fogó
- E Pinzas para conectar perfiles

300 mm	
SECTION THICKNESS GRUBOSC PROFILULUI 0.5-0.8 mm	



No.	L (mm)	
04301	300	6/24

- PL Zszywacz tapicerski
- GB Staple gun
- D Tacker
- RUS Степлер металлический с
регулирующим винтом
- CZ Čalounická sešivačka
- RO Capsator tapiterie
- H Kárpitos tűzőgép
- E Grapadora de tapicero

4-14 mm	



No.	mm	
71050	4-14	10/40

- PL Zszywacz tapicerski
- GB Staple gun
- D Tacker
- RUS Степлер
- CZ Čalounická sešivačka
- RO Capsator tapiterie
- H Kárpitos tűzőgép
- E Grapadora de tapicero

4-14 mm	



No.	mm	
71052	4-14	10/20

- PL Zszywacz tapicerski
GB Staple gun
D Tacker
RUS Crennep
- CZ Čalounická sešivačka
RO Capsator tapiterie
H Kárpitos tűzőgép
E Grapadora de tapicero

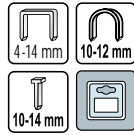

No.		
71060		6/24

- PL Rozszywacz
GB Staple remover
D Entkammerer
RUS Расшиватель
- CZ Rozešivač
RO Extractor capse
H Kapocskiszedo
E Quitagrapas

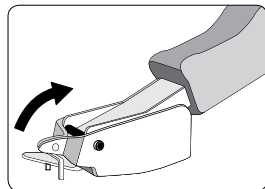

No.		
71160		10/40

- PL Zszywki typu „E” do mocowania siatki
GB Staples type „E” for mesh pliers
D Zaunringe
RUS Скобы для обжима сетки
CZ Sponky
RO Capse pt. fațut cuști
H Kapcsok madárháló rögzítéséhez
E Grapas omega



No.	for / dla	
49841	49840	10/60

- PL Zszywacz młotkowy
GB Hammer tacker
D Schnellnagler
RUS Crennep
- CZ Čalounická sešivačka
RO Capsator tapiterie
H Kárpitos tűzőgép
E Grapadora de martillo

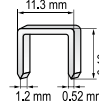
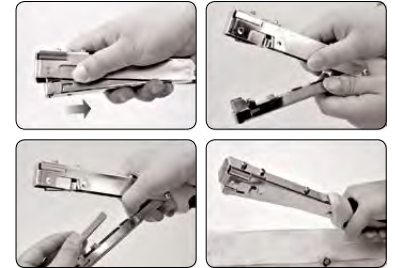
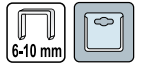

No.	mm	
71080	6-10	6/24

- PL Szczypce do mocowania siatki ogrodzeniowej
GB Mesh pliers
D Zaunklammerzange
RUS Стеллер-сшиватель для металлической сетки и сетки-рабицы
- CZ Kleště pro spojování a montáž pletiv
RO Cleste de capsat pt. fixarea gardurilor
H Fogó kerítéskapocshoz
E Hog anillo alicates

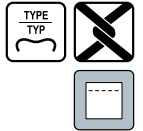

No.		
49840		50

- PL Zszywki
GB Staples
D Heftklammer
RUS Скобы
- CZ Sešivky
RO Capse tapiterie
H Tűzőkapocs
E Grapas

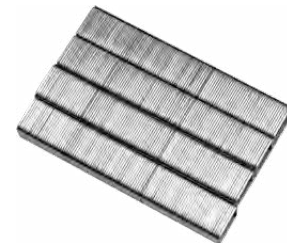

No.	mm		pcs	
72040	4	0.7x11.3	1000	60/480
72060	6	0.7x11.3	1000	60/360
72080	8	0.7x11.3	1000	60/300
72100	10	0.7x11.3	1000	60/240
72120	12	0.7x11.3	1000	50/200
72140	14	0.7x11.3	1000	40/160

PL Zszywki
GB Staples
D Heftklammern
RUS Скобы

CZ Sešivky
RO Capse tapiterie
H Tűzőkapocs
E Grapas

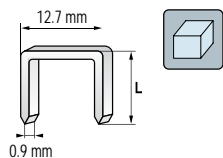

No.	L (mm)	pcs	
71970	6	12000	10
71971	10	7500	10
71972	16	4500	10

PL Zszywki
GB Staples
D Heftklammern
RUS Скобы

CZ Sešivky
RO Capse tapiterie
H Tűzőkapocs
E Grapas

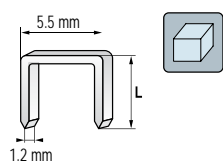

No.	L (mm)	pcs	
71975	16	2000	27
71976	21	2200	18
71977	25	2000	18
71978	38	1600	15

PL Gwoździe paprowe bębnowe
GB Coil nails
D Spulennägel
RUS Гвозди барабанные для пневмопистолета

CZ Hřebíky spojené drátem
RO Cuie in rola
H Dobtáras szeg
E Clavo en rollo

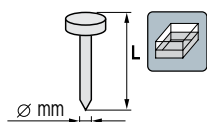

No.	L (mm)	Ø (mm)	pcs	
72000	19	3.1	4200	1
72001	22	3.1	4200	1

PL Gwoździe taśmowe
GB Nails on paper tape
D Streifennägel
RUS Гвозди отделочные для пневмопистолета

CZ Hřebík nastřelovací
RO Cuie
H Siktáras szeg
E Clavos

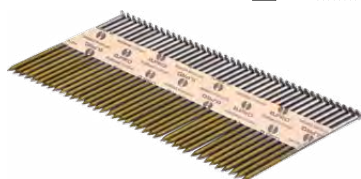
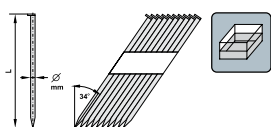

No.	L (mm)	Ø (mm)	pcs	
72010	50	2.8	3000	1
72011	65	2.8	3000	1
72012	75	2.8	3000	1
72013	90	3.1	2000	1

PL Szytyły
GB Brad nails
D Stauchkopfnägel
RUS Шпилька для степлера

CZ Kolářské hřebíky
RO Cuie fara cap
H Műanyag spakli
E Espátula de plástico

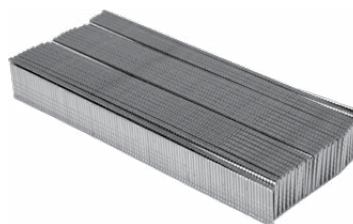
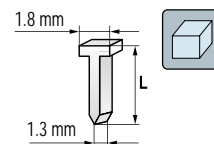

No.	L (mm)	pcs	
71980	16	5000	27
71981	30	5000	18
71982	35	5000	15
71983	50	5000	15

PL Gwoździe bębnowe
GB Coil nails
D Spulennägel
RUS Гвозди барабанные для пневмопистолета

CZ Hřebíky spojené drátem
RO Cuie in rola
H Dobtáras szeg
E Clavo en rollo

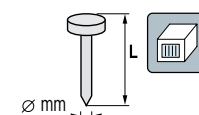

No.	L (mm)	Ø (mm)	pcs	
71990	32	2.1	7200	1
71991	38	2.1	7200	1
71992	50	2.1	5400	1
71993	64	2.5	3000	1
71994	70	2.5	3000	1
71995	75	2.5	3000	1
71996	80	2.8	3000	1
71997	90	2.8	3000	1

PL Zestaw wkrętów i kołków rozporowych
GB Screw & plug set
D Dübel- und Schrauben Sortiment
RUS Набор крепежа шурупы и дюбеля

CZ Set šroubů a hmoždinek
RO Set dibluri + holsuruburi
H Csavar és tipl készlet
E Juego de tornillos y tacos

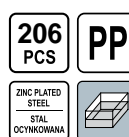

No.	pcs	
24113	206	6/24

WOOD SCREWS WITH FLAT HEAD PZ / WKRETY DO DREWNA PZ
Z LBEEM PLASKIM: 3 x 25 mm - 40 PCS, 3,5 x 35 mm - 25 PCS, 4 x 40 mm - 20 PCS, 5 x 40 mm - 15 PCS, 5 x 50 mm - 15 PCS, 6 x 60 mm - 8 PCS, WALL PLUGS PP / KOLKI PP: 5 x 25 mm - 30 PCS, 6 x 30 mm - 20 PCS, 7 x 35 mm - 15 PCS, 8 x 40 mm - 10 PCS, 10 x 50 mm - 8 PCS

PL Zestaw wkrętów i kółków rozporowych
GB Screw & plug set
D Dübel- und Schrauben Sortiment
RUS Набор крепежа шурупы и дюбеля

CZ Set šroubů a hmoždinek
RO Set dibluri + holsuruburi
H Csavar és tipli készlet
E Juego de tornillos y tacos

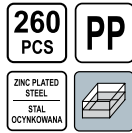

WOOD SCREWS WITH FLAT HEAD PZ / WKRETY DO DREWNA PZ Z LEBEM PLASKIM: 3,5 x 30mm - 20 PCS, 3,5 x 35 mm - 20 PCS, 4 x 40 mm - 20 PCS, 4,5 x 50 mm - 20 PCS, 5 x 60 mm - 20 PCS; WOOD SCREWS WITH CYLINDRICAL HEAD PH / WKRETY DO DREWNA PH Z LEBEM WALCOWYMI: 3,5 x 30mm - 20 PCS, 3,5 x 35 mm - 20 PCS, 4 x 40 mm - 20 PCS, 4,5 x 50 mm - 20 PCS, 5 x 60 mm - 20 PCS; WALL PLUGS PP / KOLKI PP: 5 x 31 mm - 20 PCS, 6 x 38 mm - 20 PCS, 8 x 51 mm - 20 PCS



No.	pcs	☐
24110	260	12

PL Komplet wiertel z kolkami rozporowymi
GB Drill bit and plug set
D Dübel- und Schrauben Sortiment
RUS Набор крепежа шурупы и дюбеля
CZ Set šroubů a hmoždinek
RO Set dibluri + holsuruburi
H Csavar és tipli készlet
E Juego de tornillos y tacos



METAL DRILLS / WIERTLA DO METALU: \varnothing 2, 3, 4, 5, 6, 8, 10 mm; HSS 4241;
MASONRY DRILLS / WIERTLA DO BETONU: \varnothing 4, 5, 6, 8, 10 mm;
WOOD DRILLS / WIERTLA DO DREWNA: \varnothing 4, 5, 6, 8, 10 mm;
 \varnothing 5 mm - 100 PCS; \varnothing 6 mm - 100 PCS; \varnothing 8 mm - 50 PCS; \varnothing 10 mm - 25 PCS; PP;
14' (6,3 mm): 4,5, 6 mm (L=25 mm); CrV;
14' (6,3 mm): PH1, PH2 (L=25 mm); CrV;
14' (6,3 mm): PZ1, PZ2 (L=25 mm); CrV;
14' (6,3 mm): (L=60 mm); CrV;
14' (6,3 mm): (L=12 mm)



No.	pcs	☐
24100	300	20

PL Zestaw wkrętów
GB Screw assortment
D Spanplattenschrauben Sortiment
RUS Набор винтов

CZ Šrouby
RO Set holsuruburi
H Csavar készlet
E Juego de tornillos



WOOD SCREWS WITH FLAT HEAD PZ / WKRETY DO DREWNA PZ Z LEBEM PLASKIM: 3 x 20 mm - 60 PCS, 3 x 25 mm - 50 PCS, 3,5 x 25 mm - 40 PCS, 3,5 x 30 mm - 35 PCS, 3,5 x 35 mm - 30 PCS, 4 x 20 mm - 40 PCS, 4 x 25 mm - 35 PCS, 4 x 30 mm - 30 PCS, 4 x 35 mm - 20 PCS, 4 x 40 mm - 15 PCS, 5 x 80 mm - 15 PCS



No.	pcs	☐
24120	370	6/24

PL Zestaw wkrętów i kółków rozporowych
GB Screw & plug set
D Dübel- und Schrauben Sortiment
RUS Набор крепежа шурупы и дюбеля

CZ Set šroubů a hmoždinek
RO Set dibluri + holsuruburi
H Csavar és tipli készlet
E Juego de tornillos y tacos



SCREWS WITH CYLINDRICAL HEAD PZ / WKRETY PZ Z LEBEM WALCOWYMI: 3,5 x 30 mm - 35 PCS, 4 x 40 mm - 30 PCS, 4,5 x 50 mm - 30 PCS; L-HOOK SCREWS / WKRETY Z HAKIEM PROSTYM: 2,8 x 30 mm - 35 PCS, 3,0 x 40 mm - 40 PCS, 3,8 x 50 mm - 35 PCS; WALL PLUGS PE / KOLKI PE: 5 x 30 mm - 30 PCS, 6 x 35 mm - 30 PCS, 8 x 50 mm - 20 PCS



No.	pcs	☐
24112	290	5/20

PL Zestaw wkrętów i kółków rozporowych
GB Screw & plug set
D Dübel- und Schrauben Sortiment
RUS Набор крепежа шурупы и дюбеля

CZ Set šroubů a hmoždinek
RO Set dibluri + holsuruburi
H Csavar és tipli készlet
E Juego de tornillos y tacos



WOOD SCREWS WITH FLAT HEAD PZ / WKRETY DO DREWNA PZ Z LEBEM PLASKIM: 3,5 x 12 mm - 150 PCS, 3,5 x 25 mm - 100 PCS, 3,5 x 40 mm - 50 PCS, 4 x 60 mm - 30 PCS, 4 x 75 mm - 20 PCS, 5 x 100 mm - 20 PCS; METAL SCREWS WITH FLAT HEAD PH / WKRETY DO METALU PH Z LEBEM PLASKIM: 3,5 x 25 mm - 100 PCS, 3,5 x 45 mm - 40 PCS; METAL SCREWS WITH CYLINDRICAL HEAD PH / WKRETY DO METALU PH Z LEBEM WALCOWYMI: 3,5 x 25 mm - 30 PCS; WALL PLUGS PE / KOLKI PE: 5 x 20 mm - 100 PCS, 6 x 25 mm - 100 PCS, 8 x 30 mm - 30 PCS



No.	pcs	☐
24111	770	6

PL Zestaw wkrętów
GB Screw assortment
D Spanplattenschrauben Sortiment
RUS Набор винтов

CZ Šrouby
RO Set holsuruburi
H Csavar készlet
E Juego de tornillos



WOOD SCREWS WITH FLAT HEAD PH / WKRETY DO DREWNA PH Z LEBEM PLASKIM: 3 x 20 mm - 45 PCS, 4 x 12 mm - 55 PCS; WOOD SCREWS WITH FLAT HEAD PZ / WKRETY DO DREWNA PZ Z LEBEM PLASKIM: 3 x 12 mm - 65 PCS, 3,5 x 16 mm - 50 PCS, 3,5 x 20 mm - 40 PCS, 4 x 16 mm - 40 PCS, 4 x 20 mm - 30 PCS, 4 x 25 mm - 20 PCS, 4 x 40 mm - 15 PCS, 5 x 25 mm - 15 PCS, 5 x 38 mm - 15 PCS



No.	pcs	☐
24121	390	6/24

PL Zestaw wkrętów
GB Screw assortment
D Spanplattenschrauben Sortiment
RUS Набор винтов

CZ Šrouby
RO Set holsuruburi
H Csavar készlet
E Juego de tornillos

580
PCS



WOOD SCREWS WITH FLAT HEAD PZ / WKRETY DO DREWNA PZ Z LBEM
PLASKIM: 4 x 20 mm - 50 PCS, 5 x 30 mm - 15 PCS; MACHINE SCREWS WITH
CYLINDRICAL HEAD PH WITH GASKETS / WKRETY MASZYNOWE PH Z LBEM
WALCOWYM Z PODKLADKAMI: M4 x 20 mm - 25 PCS + M4 x 25 PCS,
M5 x 25 mm - 15 PCS + M5 - 15 PCS; FLAT GASKETS / PODKLADKI
PLASKIE: M4 - 50 PCS, M5 - 30 PCS; METAL SCREWS WITH CYLINDRICAL
HEAD PH / WKRETY DO METALU PH Z LBEM WALCOWYM: 3.5 x 19 mm -
50 PCS, 4.2 x 25 mm - 30 PCS; NAILS / GWOZDZIE: 1.5 x 25 mm - 120 PCS,
2.0 x 40 mm - 50 PCS, 3.0 x 60 mm - 25 PCS; ELASTIC GASKETS / PODKLADKI
SPRĘŻYSTE: M4 - 50 PCS, M5 - 30 PCS



No.	pcs	Icon
24122	580	6/24

PL Zestaw do mocowań kabli
GB Cable manager set
D Kabelhalter-Set
RUS Набор для крепления проводов

CZ Sada na uspořádání kabelů
RO Set organizare cabluri
H Kábelkezelő készlet
E Juego para cables

124
PCS



ROUND CLIPS WITH NAIL / OKRĄGLE KLIPSY Z GWOZDZIEM: 5 mm - 40 PCS; 8 mm - 25 PCS; SELF-ADHESIVE SQUARE
CLIPS / SAMOPRZYLEPNE KWADRATOWE KLIPSY: 3.1 x 2.5 cm -
6 PCS; SELF-ADHESIVE CLIPS / SAMOPRZYLEPNE KLIPSY: 1.2 x
1.6 cm - 20 PCS; CLIP HANDLE / UCHWYT - 10 PCS; HOOK FASTE-
NER / RZEP: 2.5 x 30 cm - 3 PCS; BANDS / OPASKI: 20 cm - 20 PCS



No.	pcs	Icon
24140	124	6/60

PL Wyciskacz do mas
GB Caulking gun
D Kartuschenpistole
RUS Пистолет для герметика

CZ Protlačovač na hmoty
RO Pistol silicon
H Masszakinyomó
E Pistola para masilla

230
mm



No.	mm	Icon
09130	230	10/20

PL Zestaw haków na obrazy
GB Picture hook assortment
D Bilderhaken-Set
RUS Набор крючков для картин

CZ Sada háčků na obrazy
RO Set cârige rame
H Résztes képakasztó készlet
E Gancho cuadro

121
PCS



ABS



METAL PICTURE HOOKS / METALOWE HAKI NA OBRAZY: 0.8 cm
- 15 PCS, 2 cm - 6 PCS; PICTURE HOOKS ABS / HAKI NA OBRAZY
ABS: 3 cm - 10 PCS, 4 cm - 5 PCS; 11-STEEP HOOKS ABS /
11- STOPNIOWE HAKI NA OBRAZY ABS: 0.8 x 12.4 cm - 5 PCS;
NAILS / GWOZDZIE: 1.6 x 25 mm - 50 PCS, 2.0 x 38 mm - 30 PCS



No.	pcs	Icon
24130	121	6/60

PL Wyciskacz do mas
GB Caulking gun
D Kartuschenpistole
RUS Пистолет для герметика

CZ Protlačovač na hmoty
RO Pistol silicon
H Masszakinyomó
E Pistola para masilla

230
mm

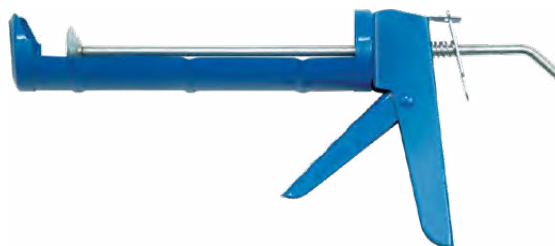

No.	mm	Icon
09100	230	20/40

PL Wyciskacz do mas
GB Caulking gun
D Kartuschenpistole
RUS Пистолет для герметика

CZ Protlačovač na hmoty
RO Pistol silicon
H Masszakinyomó
E Pistola para masilla

230
mm



No.	mm	Icon
09150	230	20/40

PL Wyciskacz do mas
GB Caulking gun
D Kartuschenpistole
RUS Пистолет для герметика

CZ Protlačovač na hmoty
RO Pistol silicon
H Masszakinyomó
E Pistola para masilla



VOREL

No.	mm	
09120	245	24

PL Aplikator do zapraw, mas szpachlowych i fugowania
GB Building and construction cement grouting gun
D Spritze für Mörtel-, Spachtel- und Fugenmaßen
RUS Аппликатор для строительных растворов, шпатлевок и затирки
CZ Aplikátor malt, plniv a spojování
RO Pompa injectat beton
H Habarcs, spatulyázó massa és fuga kinyomó
E Aplicador de mortero, masilla y para juntas

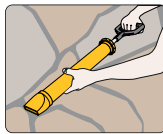

660 mm

85x20 mm

PP

ABS



VOREL

No.	L (mm)	
04450	660	24

PL Aplikator do zapraw, mas szpachlowych i fugowania
GB Building and construction cement grouting gun
D Spritze für Mörtel-, Spachtel- und Fugenmaßen
RUS Аппликатор для строительных растворов, шпатлевок и затирки
CZ Aplikátor malt, plniv a spojování
RO Pompa injectat beton
H Habarcs, spatulyázó massa és fuga kinyomó
E Aplicador de mortero, masilla y para juntas

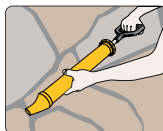

660 mm

30 mm

PP

ABS



VOREL

No.	L (mm)	
04452	660	24

PL Pistolet do pianki montażowej
GB Foam gun
D Farbspritz-Pistole
RUS Пистолет для монтажной пены

CZ Pistole na montážní pěnu
RO Pistol spuma
H Felrakó pisztoly, poliurethán habhoz
E Pistola para espuma de montaje de metalo



VOREL

No.		
09171		10/20

PL Wyciskacz do mas
GB Caulking gun
D Kartuschenpistole
RUS Пистолет для герметика

CZ Protlačovač na hmoty
RO Pistol silicon
H Masszakinyomó
E Pistola para masilla

230 mm



VOREL

No.	mm	
09160	230	6/12

PL Aplikator do zapraw, mas szpachlowych i fugowania
GB Building and construction cement grouting gun
D Spritze für Mörtel-, Spachtel- und Fugenmaßen
RUS Аппликатор для строительных растворов, шпатлевок и затирки
CZ Aplikátor malt, plniv a spojování
RO Pompa injectat beton
H Habarcs, spatulyázó massa és fuga kinyomó
E Aplicador de mortero, masilla y para juntas



660 mm

20 mm

PP

ABS



VOREL

No.	L (mm)	
04451	660	24

PL Pistolet do pianki montażowej
GB Foam gun
D Farbspritz-Pistole
RUS Пистолет для монтажной пены

CZ Pistole na montážní pěnu
RO Pistol spuma
H Felrakó pisztoly, poliurethán habhoz
E Pistola para espuma de montaje de metalo

PTFE COATED POWLEKANE



VOREL

No.		
09170		20

PL Pistolet do pianki montażowej
GB Foam gun
D Farbspritz-Pistole
RUS Пистолет для монтажной пены

CZ Pistole na montážní pěnu
RO Pistol spuma
H Felrakó pisztoly, poliurethán habhoz
E Pistola para espuma de montaje de metalo



VOREL

No.		
09172		20

PL Pistolet do pianki montażowej CZ Pistolet na montážní pěnu
 GB Foam gun RO Pistol spuma
 D Farbspritz-Pistole H Felrakó pisztoly, poliurethán habhoz
 RUS Пистолет для монтажной пены E Pistola para espuma de montaje de metalo



No.	pcs	box
09174	20	20

PL Opaska ślimakowa z etykieta CZ Šneková páska
 GB Hose clip RO Colier metalic
 D Schlauchklemme H Csigapánt
 RUS Хомут стальной E Abrazadora



No.	Ø (mm)	↑ mm	box
73515	6-12	7.5	100
73516	8-14	7.5	100
73517	10-16	7.5	100
73521	12-20	9.0	100
73522	16-25	9.0	100
73523	20-32	9.0	100
73525	30-45	9.0	50
73527	40-60	9.0	50
73528	55-70	9.0	50
73529	65-80	9.0	50
73530	75-95	9.0	50
73532	90-110	9.0	50
73533	105-120	9.0	50
73534	115-130	9.0	50
73535	125-140	9.0	50
73536	145-160	9.0	50
73539	175-190	9.0	50
73540	190-205	9.0	50

PL Komplet opasek ślimakowych CZ Sada šnekových pásek
 GB Hose clip set RO Set coliere metalice
 D Schlauchklemmensatz H Csigapántkészlet
 RUS Набор хомутов E Juego de abrazadoras



No.	pcs	box
73590	8	25

PL Pistolet do pianki montażowej CZ Pistolet na montážní pěnu
 GB Foam gun RO Pistol spuma
 D Farbspritz-Pistole H Felrakó pisztoly, poliurethán habhoz
 RUS Пистолет для монтажной пены E Pistola para espuma de montaje de metalo



No.	pcs	box
09173	20	20

PL Opaska ślimakowa CZ Šneková páska
 GB Hose clip RO Colier metalic
 D Schlauchklemme H Csigapánt
 RUS Хомут стальной E Abrazadora



No.	Ø (mm)	box
73561	8-12	100
73562	10-16	100
73563	12-22	100
73565	16-27	100
73567	20-32	100
73568	25-40	100
73569	35-50	50
73570	40-60	50
73571	50-70	50
73572	60-80	25
73573	70-90	25
73574	80-100	25
73575	90-110	25

PL Komplet opasek ślimakowych CZ Sada šnekových pásek
 GB Hose clip set RO Set coliere metalice
 D Schlauchklemmensatz H Csigapántkészlet
 RUS Набор хомутов E Juego de abrazadoras



No.	Ø (mm)	pcs	box
73831	8-12	4	4/40
73833	12-22	4	40
73835	20-32	4	40

PL Opaska ślimakowa CZ Śnekowa paska
GB Hose clip RO Coliere metallic
D Schlauchklemmen H Csigapánt
RUS Хомут стальной E Abrazadora



No.	Ø (mm)	
73612	6-12	100
73614	8-14	100
73616	10-16	100
73620	12-20	100
73621	14-20	100
73625	16-25	100
73627	18-27	100
73632	20-32	100
73640	25-40	100
73645	35-50	50
73660	40-60	50
73670	55-70	50
73680	65-80	50
73695	75-95	50
73700	80-100	50
73710	90-110	50
73720	105-120	50
73730	115-130	50
73740	125-140	50
73775	160-175	50
73820	205-220	50

PL Opaski plastikowe CZ Plastiková páska
GB Cable ties RO Set coliere din plastic
D Kabelbinder H Műanyag pánt
RUS Хомуты-стяжки пластиковые E Abrazadoras de plasticó

PA 6.6 UL P4V2



No.	mm	max tensile strength / max odporność na zrywanie (kg)	wire bundle max Ø / max Ø wiązki kabli (mm)	pcs	
73892	100x2.5	8	20	100	250/500
73893	150x2.5	8	40	100	250/500
73894	200x2.5	8	50	100	125/250
73895	300x3.6	18	80	100	75/150
73929	280x4.8	22	80	100	50/100
73896	370x4.8	22	100	100	50/100
73897	430x4.8	22	120	100	35/70
73898	500x8.0	54	130	50	30/60

PL Komplet serwisowy CZ Dėlnická sada
GB Hose clip set RO Set coliere metalice
D Schlauchklemmensatz H Szervizkészlet
RUS Набор хомутов E Juego de juntas



No.	pcs	
73598	365	1

PL Opaska ślimakowa do węża CZ Śnekowa paska
GB Hose clip RO Coliere metallic
D Schlauchklemme H Csigapánt
RUS Хомуты для шлангов E Abrazadora



No.	Ø (mm)	for hose / do węża Ø	pcs	
73506	12-20	1/2" (12.5 mm)	4	20
73507	16-25	3/4" (19.0 mm)	4	10/20
73508	20-32	1" (25.0 mm)	4	20
73510	12-20	1/2" (12.5 mm)	4	20
	16-25	3/4" (19.0 mm)	4	20
73511	16-25	3/4" (19.0 mm)	4	20
	20-32	1" (25.0 mm)	4	20

PL Opaski plastikowe CZ Plastiková páska
GB Cable ties RO Set coliere din plastic
D Kabelbinder H Műanyag pánt
RUS Хомуты-стяжки пластиковые E Abrazadoras de plasticó

PA 6.6 UL P4V2



No.	mm	max tensile strength / max odporność na zrywanie (kg)	wire bundle max Ø / max Ø wiązki kabli (mm)	pcs	
73881	80x2.5	8	15	100	250/500
73882	100x2.5	8	20	100	250/500
73883	150x2.5	8	40	100	250/500
73884	200x2.5	8	50	100	125/250
73885	300x3.6	18	80	100	75/150
73906	200x4.8	22	50	100	75/150
73909	280x4.8	22	80	100	50/100
73886	370x4.8	22	100	100	50/100
73887	430x4.8	22	120	100	35/70
73888	500x8.0	54	130	50	30/60

- PL Zaciskacz do opasek kablowych
- GB Nylon cable tie gun
- D Kabelbinder Verschluss Werkzeug
- RUS Пистолет для кабельных стяжек
- CZ Kliešte viazacie káblové
- RO Cleste pt. strans coliere plastic
- H Kábelkötégető fogó
- E Herramienta de cierre para tensado y corte nylon alambre

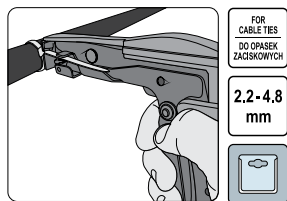

FOR CABLE TIES DO OPASEK KABELSKOWYCH

2.2-4.8 mm



No.	mm	kg	Box
73875			10/40

- PL Wkłady klejowe
- GB Glue sticks
- D Heissklebepatronen
- RUS Тубы для клеевого пистолета
- CZ Lepici vložky
- RO Articole plastic (pt. pistol lipit)
- H Ragasztóbetét
- E Cartucho de cola

WORKING TEMPERATURE PRACY 170-200°C

SOFTENING POINT TEMPERATURA MIEKNIENIA 85+/-2°C

TRANSPARENT BEZBARWNE

UNIVERSAL UNIWERSALNE



application: cardboard, wood, plastic, leather, fabrics
zastosowanie: tektura, drewno, plastik, skóra, tkaniny



No.	mm	pcs	Box
73260	7x100	12	50/200
73270	11x100	6	20/120
73271	11x150	12	20/60

- PL Podajnik taśmy pakowej
- GB Packing tape dispenser
- D Verpackungsband-Abroller
- RUS Диспенсер для клейких лент
- CZ Páskovačka
- RO Pistol cu banda de impachetare
- H Csomagolószalag tépő
- E Precindadora de plástico

76 mm

115 mm

50 mm



No.	W (mm)	Box
75295	50	12/24

- PL Wkłady klejowe
- GB Glue sticks
- D Heissklebepatronen
- RUS Тубы для клеевого пистолета

- CZ Lepici vložky
- RO Articole plastic (pt. pistol lipit)
- H Ragasztóbetét
- E Cartucho de cola

WORKING TEMPERATURE PRACY 170-200°C

SOFTENING POINT TEMPERATURA MIEKNIENIA 85+/-2°C

TRANSPARENT BEZBARWNE

UNIVERSAL UNIWERSALNE



application: cardboard, wood, plastic, leather, fabrics
zastosowanie: tektura, drewno, plastik, skóra, tkaniny



No.	mm	kg	Box
73300	11x200	1	10

- PL Dozownik kleju
- GB Glue applicator - bottle kit
- D Applikator-Flasche für Flüssigklebstoffe
- RUS Аппликатор клея
- CZ Aplikátor lepidla
- RO Kit aplicator lipici
- H Lamellaragasztó
- E Aplicador de pegamento

0.25 l

PVA GLUE KLEJ

60 mm

40 mm



No.	Box
78027	50

- PL Taśma pakowa brązowa
- GB Packing tape, brown
- D Verpackungsband aus PP, braun
- RUS Упаковочная клейкая лента
- CZ Balící páska PP hnědá
- RO Bandă ambalare PP maro
- H PP barna ragasztószalag
- E Cinta de embalaje PP marrón

OPP



No.	W (mm)	L (m)	Box
75301	48	40	72
75302	48	66	36

PL Taśma pakowa przezroczysta
 GB Packing tape, transparent
 D Verpackungsband aus PP, durchsichtig
 RUS Упаковочная клейкая лента
 CZ Balící páska PP průhledná
 RO Bandă ambalare PP transparentă
 H Átlátszó ragasztószalag
 E Cinta de embalaje PP transparente



No.	W (mm)	L (m)	
75303	48	40	36
75304	48	66	36

PL Taśma papierowa samoprzylepna
 GB Self adhesive paper tape
 D Papierband selbstklebend
 RUS Лента малярная бумажная
 CZ Páska papírová samolepící
 RO Banda adeziva hartie
 H Öntapadó papírszalag
 E Cinta de papel adhesiva



No.	W (mm)	L (m)	
75270	19	25	12/48
75271	25	25	36
75272	30	25	10/40
75273	38	25	6/24
75274	48	25	6/24
75285	25	50	9/36
75286	30	50	10/40
75287	38	50	6/24
75288	48	50	6/24

PL Taśma dwustronna do wykładzin
 GB Double-sided carpet tape
 D Doppelseitiges Klebeband für Auslegware
 RUS Двухсторонняя клейкая лента для укладки ковровых покрытий
 CZ Obojstranná lepicí páska (na podlahové krytiny)
 RO Bandă cu două părți adezive pt. mochetă
 H Kétoldalas szalag szőnyegpadlókhöz
 E Cinta doble cara para alfombras



No.	W (mm)	L (m)	
75260	50	5	48
75261	50	10	36
75262	50	25	24

PL Taśma pakowa
 GB Packing tape
 D Band
 RUS Упаковочная клейкая лента
 CZ Balící páska
 RO Banda scotch
 H Csomagolószalag
 E Cinta de embalaje



No.	W (mm)	L (m)	
75300	48	45	12/36

PL Taśma maskująca, niebieska
 GB Blue masking tape
 D Malerei blau Tape
 RUS Малярная стрічка
 CZ Maskovací páska
 RO Bandă de mascare
 H Fedőszalag
 E Cinta de enmascarar



No.	W (mm)	L (m)	
75120	30	25	40
75121	38	25	24
75122	48	25	24
75123	30	50	40
75124	38	50	24
75125	48	50	24

PL Taśma tynkarska elewacyjna
 GB Plastering tape
 D Putzband
 RUS Штукатурные лента
 CZ Fasádní omítková páska
 RO Banda mascare pt. tencuieli
 H Homlokzati festő szalag
 E Cinta de escayola



No.	W (mm)	L (m)	
75130	38	20	24
75131	48	20	24
75132	38	50	28
75133	48	50	24

PL Taśma dwustronna na folii
 GB Double-sided tape
 D Doppelseitiges Band auf PP-Folie
 RUS Клейкая лента двухсторонняя на полипропиленовой основе
 CZ Obojstranná páska na PP folii
 RO Bandă cu două fețe pt. folii
 H Kétoldalas
 E Cinta doble cara sobre la base de PP



No.	W (mm)	L (m)	
75245	50	5	72
75246	50	10	72
75247	50	25	36

- PL Taśma samoprzylepna dwustronna
 GB Mounting tape
 D Doppelseitiges Montageband
 RUS Двухсторонняя монтажная лента
 CZ Páska montážní dvouvrstvá
 RO Scotch cu banda dubla
 H Kétoldalas ragasztószalag
 E Cinta adhesiva, ambos lados

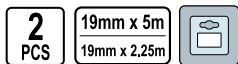

No.	W (mm)	L (m)	
75100	19	2.25/5	12/96

- PL Taśma ostrzegawcza
 GB Warning tape
 D Warnband, klebend
 RUS Лента сигнальная
- CZ Lepící páska výstražná
 RO Bandă adezivă avertizare
 H Figyelmeztető ragasztó szalag
 E Cinta adhesiva de advertencia

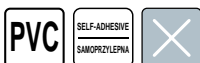

No.	W (mm)	L (m)	
75231	48	33	24

- PL Taśma ostrzegawcza dwukolorowa
 GB Two-colour warning tape
 D Zweifärbiges Warnband
 RUS Лента сигнальная
- CZ Páska výstražná dvojbarevná
 RO Banda de avertizare bicolora
 H Kétszínű jelzőszalag
 E Cinta de advertencia bicolor



No.	W (mm)	L (m)	
75233	75	100	24

- PL Taśma PCV
 GB PVC Tape
 D PVC Band
 RUS Изолента ПВХ
- CZ Páska PVC
 RO Banda izolatoare PVC
 H PVC Szalag
 E Cinta PVC



No.	W (mm)	thickness / grubość (mm)	L (m)	pcs	
75000	19	0.13	10	10	50
75050	50	0.13	10	1	25/100

- PL Taśma tekstylna „DUCT”
 GB „DUCT” tape
 D Textilband „DUCT”
 RUS Лента армированная на тканевой основе

- CZ Textilní páska „DUCT”
 RO Bandă textilă „DUCT”
 H „DUCT” textil szalag
 E Cinta textil „DUCT”



No.	W (mm)	L (m)	
75238	48	10	24
75239	38	50	28
75240	48	50	24

- PL Taśma ostrzegawcza
 GB Warning tape
 D Warnband, klebend
 RUS Лента сигнальная
- CZ Lepící páska výstražná
 RO Bandă adezivă avertizare
 H Figyelmeztető ragasztó szalag
 E Cinta adhesiva de advertencia

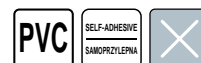

No.	W (mm)	L (m)	
75230	48	33	24

- PL Taśma aluminiowa
 GB Aluminium tape
 D Aluminiumband
 RUS Алюминиевая клейкая лента
- CZ Hliníková páska
 RO Bandă aluminiu
 H Alumínium szalag
 E Cinta de aluminiu



No.	W (mm)	L (m)	
75140	48	10	36
75141	48	50	24

- PL Taśma PCV
 GB PVC Tape
 D PVC Band
 RUS Изолента цветная
- CZ Páska PVC
 RO Banda izolatoare PVC
 H PVC Szalag
 E Cinta PVC

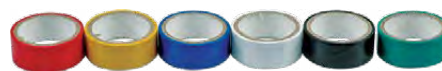

No.	W (mm)	thickness / grubość (mm)	L (m)	pcs	
75060	19	0.13	3	6	10/100

PL Zestaw taśm izolacyjnych PCV
GB Set of PVC insulating tapes
D Satz von PVC-Isolierbändern
RUS Изолента цветная

CZ Sada izolačních pásek PVC
RO Set de benzi de izolare din PVC
H PVC szigetelő szalag készlet
E Juego de cintas aislantes PVC

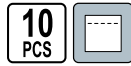

No.	W (mm)	thickness / grubość (mm)	L (m)	pcs	
75012	15	0.13	10	10	36
75028	19	0.13	20	10	20

PL Taśma samowulkanizująca
GB Self-vulcanization tape
D Selbstvulkanisierendes Band
RUS Самовулканизирующаяся лента

CZ Páska samovulkanizační
RO Banda autovulcanizanta
H Önvulkanizáló szalag
E Cinta autovulcanizadora



No.	W (mm)	thickness / grubość (mm)	L (m)	
75035	19	0.8	10	5/30
75036	25	0.8	5	5/30

PL Sznurek murarski
GB Builders line
D Maurerschnur
RUS Шнур каменщика

CZ Šňůra zednická
RO Sfoară pt. zidari
H Kőműves zsinór
E Cuerda de albañil

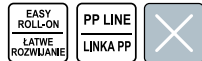

No.	Ø (m)	L (m)	
17497	1.2	75	12/48
17498	1.2	200	12/48

PL Sznurek murarski
GB Builders line
D Maurerschnur
RUS Шнур - причалка

CZ Šňůra zednická
RO Sfoară pt. zidari
H Kőműves zsinór
E Cuerda de albañil

No.	L (m)	
17490	40	80

PL Taśma PCV do użytku zewnętrznego
GB PVC tape
D PVC Band
RUS Лента ПВХ для внешних работ

CZ Páska PVC
RO Bandă PVC
H Kétoldalas PVC
E Cinta PVC



No.	W (mm)	L (m)	
75031	48	33	50

PL Sznurek murarski
GB Builders line
D Maurerschnur
RUS Шнур каменщика

CZ Šňůra zednická
RO Sfoară pt. zidari
H Kőműves zsinór
E Cuerda de albañil

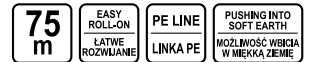

No.	L (m)	
17495	75	12/48

PL Sznurek murarski
GB Builders line
D Maurerschnur
RUS Шнур каменщика

CZ Šňůra zednická
RO Sfoară pt. zidari
H Kőműves zsinór
E Cuerda de albañil



No.	L (m)	colour / kolor	
17488	50		60
17489	100		60



PL Linka pleciona polipropylenowa CZ Lano pletené polypropylenové
 GB Polypropylene sennit line RO Coarda împletita din polipropilena
 D Geflochtenes Seil aus Polypropylen H Polipropilén fonott kötél
 RUS Канат полипропиленовый плетёный E Cuerda trenzada de polipropileno



No.	Ø (mm)	L (m)	
69502	4	400	4
69503	5	250	4
69504	6	250	4
69505	8	300	2
69506	10	200	2
69507	12	180	1
69508	14	110	1
69509	16	80	1
69510	18	70	1

PL Sznurek murarski, polipropylenowy CZ Šňúra zednická polypropylenová
 GB Polypropylene bricklayer's string RO Şnur de zidărie din polietilena
 D Maurerschnur aus Polypropylen H Kőműves zsinór, polipropilén
 RUS Шнур каменщика E Cordel de albañilería



PL Sznurek murarski polietylenowy CZ Šňúra zednická polyetylenová
 GB Polyethylene bricklayer's string RO Şnur de zidărie din polietilena
 D Maurerschnur aus Polyäthylen H Kőműves zsinór, polietilén
 RUS Полиэтиленовый шнур каменщика E Cordel de albañilería de polietileno



No.	Ø (mm)	L (m)	
17470	1.7	50	60/240
17471	1.7	100	30/120
17473	2.0	50	60/240
17474	2.0	100	30/120

PL Linka pleciona polipropylenowa CZ Lano pletené polypropylenové
 GB Polypropylene sennit line RO Coarda împletita din polipropilena
 D Geflochtenes Seil aus Polypropylen H Polipropilén fonott kötél
 RUS Канат полипропилен



PL Sznurek PP pleciony, uniwersalny CZ Šňúra PP pletená univerzální
 GB Universal PP sennit string RO Şnur PP împletit, universal
 D PP-Schnur, geflochten, universell H PP fonott kötél, univerzális
 RUS Шнур полипропиленовый E Cordel trenzado universal PP



No.	Ø (mm)	L (m)	
69620	3	10	50
69621	3	20	40

PL Linka jutowa skręcana CZ Lano jutová kroucená
 GB String jute rope RO Cablu răsucit de iută
 D Verdrillt Seil aus Jute H Juta sodrott kötél
 RUS Канат джутовый E Cable de yute torcido



PL Sznurek pakowy, jutowy CZ Šňúra ucpávková jutová
 GB Packing jute string RO Şnur de împachetat, de iută
 D Packschnur, aus Jute H Csomagkötöző spárga, juta
 RUS Шнур джутовый E Cordel de yute para embalaje



No.	dkg	
69630	5	112
69631	10	100



No.	Ø (mm)	L (m)	
69572	10	10	20

PL Nici lniane, dratwa
 GB Flax thread, twine
 D Leinenfaden, Pechfaden
 RUS Нить (дратва) льняная

CZ Nitě lněné, dratev
 RO Fire de in, fire
 H Len cérna, fonál
 E Hilo de lino, cabo de zapatero



No.	kg	
69635	10	28
69637	25	18

PL Linka pleciona, elastyczna
 GB Elastic sennit line
 D Geflochtenes Seil, elastisch
 RUS Канат плетёный эластичный

CZ Lano pletené elastické
 RO Coarda împletita, elastica
 H Fonott kötél, rugalmas
 E Cuerda trenzada elástica

RUBBER CORE
 GUMOWY RDZE



No.	Ø (mm)	L (m)	
69550	6	150	1
69551	8	100	1
69552	10	100	1

PL Lina igłowa
 GB Needle rope
 D Nadelseil
 RUS Канат полипропиленовый, плетёный

CZ Lano s jádrem opletené
 RO Cablu ac
 H Túfonatos kötél
 E Cable acalabrotado



No.	Ø (mm)	L (m)	
69539	8	10	30
69540	8	20	20
69542	10	10	25
69543	10	20	15
69546	12	20	10

PL Sznurek PP do podwiązania wełny izolacyjnej
 GB Spliced wire polypropylene string
 D Polypropylen Emtegar
 RUS Шнур полипропиленовый
 CZ Provázek polypropylenový
 RO Snur din polipropilena
 H Špagát polypropylénový
 E Cuerda



No.	Ø (mm)	L (m)	
69608	2.5	200	100
69609	2.5	300	80
69610	2.5	450	50
69612	2.5	1000	24
69613	2.5	2000	12

Memo

11

Plastering & bricklaying tools Narzędzia budowlane i malarskie



Floor laminate cutters Gilotyny do cięcia paneli podłogowych	
.....	148

Tile cutters & accessories Przyrządy do cięcia glazury i akcesoria	
.....	148-154

Tile cutters Przyrządy do glazury.....	148
--	-----

Tile cutting pliers Szcypce do glazury.....	149
---	-----

Grout removers & finishers Skrobaki i szpachelki do fug.....	150
--	-----

Accessories for tiles Akcesoria do glazury.....	150
---	-----

Burners & soldering tools Palniki i lutownice	
.....	154-155

Gas burners & accessories Palniki gazowe i akcesoria	
.....	155-156

Ladders & supports Drabiny i podpory	
.....	156-158

Masonry tools Narzędzia budowlane	
.....	158-179

Floats Pace.....	158
----------------------------	-----

Trowels Kielnie.....	161
--------------------------------	-----

Plaster & stucco spray guns Tynkownice pneumatyczne.....	161
--	-----

Tools for areated blocks Narzędzia do betonu komórkowego.....	161
---	-----

Tools for drywalls Narzędzia do płyt gipsowo-kartonowych.....	162
---	-----

Putty knives Szpachelki.....	163
--	-----

Scrapers Skrobaki.....	165
----------------------------------	-----

Mason's pans Czerpaki murarskie.....	166
--	-----

Building strainers Sita budowlane.....	167
--	-----

Paint mixers & grout mixers Mieszadła do farb i do zaprawy.....	167
---	-----

Paint rollers & accessories Wálki do malowania i akcesoria.....	168
---	-----

Paint brushes Pędzle malarskie.....	171
---	-----

Multipurpose trays Podstawki gospodarcze.....	172
---	-----

Painting sheets Folie malarskie.....	173
--	-----

Tapes Taśmy.....	173
----------------------------	-----

Plastic buckets & tubs Wiadra i kaski budowlane.....	175
--	-----

Suction lifters Uchwyty do szyb.....	176
--	-----

Hooks „Juco” Haki budowlane „Juco”.....	177
---	-----

Carpenter's pencils & accessories Ołówki stolarskie i akcesoria.....	177
--	-----

Benders Giętarek.....	177
---------------------------------	-----

Paving tools Narzędzia brukarskie.....	178
--	-----

PL Gilotyňa do cięcia paneli
GB Floor laminate cutter
D Laminat-Schneider
RUS Резак для ламината

CZ Nužky na laminatove plovoucí podlahy
RO Aparat de taiat parchet laminat
H Laminált padló vágógép
E Guillotina cortapaneles

12 mm max.
CUTTING THICKNESS
GRUBOSC CIĘCIA

210 mm max.
CUTTING LENGTH
DŁUGOSC CIĘCIA

ZINC PLATED
CYNKOWANE



VOREL

No.	mm	Ø (mm)	Box
28880			2

PL Przyrząd do cięcia glazury
GB Tile cutting machine
D Fliesenschneidemaschine
RUS Плиткорез

CZ Přístroj na řezání glazury
RO Aparat de taiat faianța
H Csempevágó
E Cortadora de gres

450 mm

16x6x3 mm

19 Ø (mm)

0-45°

30-80 Ø (mm)



VOREL

No.	mm	Ø (mm)	Box
00320	450	19	1

PL Przyrząd do cięcia glazury
GB Tile cutting machine
D Fliesenschneidemaschine
RUS Плиткорез

CZ Přístroj na řezání glazury
RO Aparat de taiat faianța
H Csempevágó
E Cortadora de gres

22x6x2 mm

16 Ø (mm)

0-45°



VOREL

No.	mm	Ø (mm)	Box
00510	500	16	1
00610	590	16	1

PL Przyrząd do cięcia glazury
GB Tile cutting machine
D Fliesenschneidemaschine
RUS Плиткорез

CZ Přístroj na řezání glazury
RO Aparat de taiat faianța
H Csempevágó
E Cortadora de gres

22x6x2 mm

15 Ø (mm)

0-90°

PTFE



VOREL

No.	mm	Ø (mm)	Box
01060	600	15	1

PL Przyrząd do cięcia glazury
GB Tile cutting machine
D Fliesenschneidemaschine
RUS Плиткорез

CZ Přístroj na řezání glazury
RO Aparat de taiat faianța
H Csempevágó
E Cortadora de gres

600 mm

16x6x3 mm

19 Ø (mm)

0-45°

30-80 Ø (mm)



VOREL

No.	mm	Ø (mm)	Box
00300	600	19	1

PL Przyrząd do cięcia glazury
GB Tile cutting machine
D Fliesenschneidemaschine
RUS Плиткорез

CZ Přístroj na řezání glazury
RO Aparat de taiat faianța
H Csempevágó
E Cortadora de gres

22x6x2 mm

0-90°



VOREL

No.	mm	Ø (mm)	Box
00600	580	20	1

PL Przyrząd do cięcia glazury
GB Tile cutting machine
D Fliesenschneidemaschine
RUS Плиткорез

CZ Přístroj na řezání glazury
RO Aparat de taiat faianța
H Csempevágó
E Cortadora de gres

280 mm

16 Ø (mm)

15x6x1.5 mm

0°



No.	mm	Ø (mm)	Box
02300	280	16	6

PL Przyrząd do cięcia glazury
GB Tile cutting machine
D Fliesenschneidemaschine
RUS Плиткорез

CZ Přístroj na řezání glazury
RO Aparat de taiat faianța
H Csempevágó
E Cortadora de gres

400 mm

15x6x1.5 mm

14 Ø (mm)

0°



No.	mm	Ø (mm)	Box
02400	400	14	6

PL Kółko wymienne ze śrubą
GB Tile cutting wheel
D Schneidrad mit Schraube
RUS Запасной ролик для плиткореза

CZ Výměnné kolečko se šroubem
RO Cuițit rolă
H Cseregőgő csavarral
E Recambio de cuchillo redondo



No.	mm	for / dla	
03150	15x6x1.5	02300; 02400	50/200
03160	16x6x3	00300; 00320	50/200
03220	22x6x2	00510; 00600; 00610; 01060	50/200

PL Szczypce do glazury
GB Tile cutting pliers
D Glasurzange
RUS Кусачки для плитки

CZ Kleště do glazury
RO Clește rupt faianța
H Csempefőgő
E Tenazas para azulejos



No.	L (mm)	mm	
04000	200	15	10/60

PL Szczypce do cięcia glazury
GB Tile cutting pliers
D Glasurzange
RUS Кусачки для плитки

CZ Kleště do glazury
RO Clește rupt faianța
H Csempefőgő
E Tenazas para azulejos



No.	L (mm)	
04020	200	6/36

PL Szczypce do glazury
GB Tile cutting nipper
D Glasurzange
RUS Клещи для плитки твердосплавные

CZ Kleště do glazury jednoduché
RO Clește drept pt. glazură
H Egyenes csempéharapófőgő
E Tenazas para azulejos recto



No.	L (mm)	
04200	200	12/60

PL Kółko tnące wymienne
GB Tile cutting wheel
D Schneidrad
RUS Запасной ролик для плиткореза

CZ Výměnné kolečko
RO Cuițit rolă
H Cseregőgő csavarral
E Recambio de cuchillo redondo



No.	mm	for / dla	
03221	22x10.5x2	00703	50/200

PL Szczypce do cięcia i łamania glazury
GB Tile cutting pliers
D Glasurzange
RUS Кусачки для плитки

CZ Kleště do glazury
RO Clește rupt faianța
H Csempefőgő
E Tenazas para azulejos



No.	L (mm)	
04001	215	50

PL Szczypce do łamania glazury
GB Tile cutting pliers
D Glasurzange
RUS Кусачки для плитки

CZ Kleště do glazury
RO Clește rupt faianța
H Csempefőgő
E Tenazas para azulejos



No.	L (mm)	
04022	200	6/60

PL Obcęgi do glazury wygięte
GB Tile cutting nipper
D Glasurzange
RUS Клещи для плитки твердосплавные

CZ Kleště do glazury ohnuté
RO Clește curbă pt. glazură
H Hajlított csempéharapófőgő
E Tenazas para azulejos curvo



No.	L (mm)	
04210	200	12/60

PL Skrobak do fug
GB Grout remover
D Fugenreiniger
RUS Скребок для швов плитки

CZ Škrabák na spáry
RO Spaclu pt. rosturi
H Fugakihúzó
E Rascador para juntas



No.
04400

40/400

PL Szpachelka do fug
GB Grout finisher
D Fugenreiniger
RUS Шпатель для затирки межплиточных швов

CZ Šušev skrēpers
RO Răzuitoare pt. rosturi
H Fugakihúzó
E Rascador para juntas



No.
04410

450

PL Skrobak do fug
GB Grout remover
D Fugenreiniger
RUS Скребок для швов плитки

CZ Škrabák na spáry
RO Spaclu pt. rosturi
H Fugakihúzó
E Rascador para juntas

TUNGSTEN
CARBIDE
WEGLIK
WOLFRAMU



No.
04405

mm
50x2

12/60

PL Piłka z brzeszczotem wolframowym
GB Tile saw
D Handsäge mit Wolfram-Sägedraht
RUS Пилка с карбид-вольфрамовым напылением

CZ Piłka na obklady a dlaždice
RO Fierăstrău pt. placi ceramice
H Fűrész csempéhez, kerámiához
E Sierra hilo carburo tungsteno

150
mm

6"

TCT



No.
27540

size / rozmiar
6" (150 mm)

5/60

PL Skrobak do fug
GB Grout remover
D Fugenreiniger
RUS Скребок для швов кладки

CZ Škrabák na spáry
RO Răzuitoare pt. rosturi
H Fugakihúzó
E Rascador para juntas



No.
04406

40/160

PL Worek do aplikacji fugi
GB Grout bag
D Fugenfüller-beutel
RUS Мешок для нанесения расшивки

CZ Rukáv do spárování
RO Punga umplere rosturi
H Fugázó zsák
E Saco para la aplicación de juntas

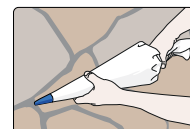

No.
04440

36/108

PL Laser glazurnicz
GB Tile laser
D Fliesenlaser
RUS Уровень лазерный для укладки плитки

CZ Laserové vodováha
RO Nivelă cu laser pt. faianța și gresie
H Csempelézer
E Laser de baldosas de cuadrado

2
PRECISION
VIALS
LIBELLE

ABS

3x1.5V
(AA)
NOT INCLUDED
NE SAUJUCINE



No.
16030

vials / libelle
2

20

PL Wycinarka do otworów w glazurze
GB Circular tile cutter
D Fliesenbohrzeug
RUS Резак по плитке
CZ Vyseč otvorů v glazúře
RO Cútit rotativ taiat faianța
H Lyukkivágó csempéhez
E Ruleta de corte para azulejos

20-90
Ømm

TCT



No.
03900

Ø (mm)
20-90

80/160

- PL Wycinarka do otworów w glazurze
 GB Circular tile cutter
 D Fliesenbohrzeug
 RUS Резак по плитке
 CZ Výseč otvorů v glazuře
 RO Cutit rotativ taiat faianta
 H Lyukkivágó csempéhez
 E Ruleta de corte para azulejos



No.	Ø (mm)	
03920	30-80	10/100

- PL Ostrze zapasowe do wycinarki 03940
 GB Spare blades for 03940
 D Schneide für 03940
 RUS Запасные элементы для резака 03940
- CZ Náhradní soustava na vystřihovačku H03940
 RO Lame rezerva pt. 03940
 H Tartalékkészlet a 03940 kivágóhoz
 E Juego de recambios para ruleta 03940



No.	for / dla	
03950	03940	20/200

- PL Rysik do cięcia i łamania glazury
 GB TC tile cutter and breaker
 D Fliesengriffel und Brecher
 RUS Плиткорез-карандаш с отламывателем
- CZ Rýsovací jehla na řezání a lámání glazury
 RO Cutit taiat / rupt faianta
 H Karctű csempévágáshoz és töréshez
 E Cortador y rompedor de azulejos



No.	L (mm)	
04100	200	10/100

- PL Maskownica uniwersalna
 GB Magnetic lock
 D Universal verdeckung mit Magnet
 RUS Замок магнитный для кафеля
- CZ Maskovací rám univerzální do glazury
 RO Opritor magnetic
 H Univerzális maszkoló csempéhez
 E Cierre magnetico universal



No.		
04510		40

- PL Wycinarka do otworów w glazurze
 GB Circular tile cutter
 D Fliesenlochbohrer mit Handschutz
 RUS Резак по плитке „Балеринка” с защитной решеткой

- CZ Výseč otvorů v glazuře
 RO Cutit rotativ taiat faianta
 H Lyukkivágó csempéhez
 E Ruleta de corte para azulejos



No.	Ø (mm)	
03940	20-94	24

- PL Rysik do cięcia glazury
 GB Hand tile cutter and breaker
 D Fliesengriffel
 RUS Резак для плитки
- CZ Rýsovací jehla na řezání glazury
 RO Cutit taiat / rupt faianta
 H Karctű csempévágáshoz
 E Cortador de azulejos



No.	L (mm)	
04050	130	50/400

- PL Przyrząd do poziomowania płytek
 GB Tile leveling set
 D Schlagschnurgerät
 RUS Уровень для укладки кафеля
- CZ Přístroj pro regulaci úrovně dlaždiček
 RO Fir pt. trasat
 H Padlólapszintező eszköz
 E Nivelador de cuerda para azulejos



No.		
04500		60

- PL Uchwyty magnetyczne do płytek
 GB Tile magnetic fittings
 D Fliesen Magnete
 RUS Магнитные фитинги для плитки
- CZ Magnety pod obklady
 RO Balanale magnetice pt. imbinarea placilor
 H Csempemágnes
 E Trampilla magnetica para la escotilla de inspección

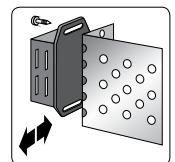

No.	pcs	
04490	4	50/100

PL Gąbka glazurnicza
GB Glazing sponge
D Fliesenschwamm
RUS Губка для затирки плитки

CZ Houba na spárování obkladů
RO Burete pt. plăci ceramice
H Csempézó szivacs
E Esponja para esmaltar



No.	mm	
04540	165x100x60	74

PL Gąbka glazurnicza dwuwarstwowa
GB Double glazing sponge
D Doppelter Fliesenschwamm
RUS Губка для затирки плитки

CZ Houba na spárování obkladů dvoustranná
RO Burete pt. plăci ceramice dublu
H Dupla csempézó szivacs
E Esponja para esmaltar doble



No.	mm	
04544	165x100x80	18

PL Wiadro glazurnicze
GB Glaze bucket
D Fliesenwaschset Rolleneimer
RUS Ведро с роликами для затирки швов
CZ Malířské vědro
RO Galeata pt. zugravit
H Fugázó vödör
E Cubo de pintura



No.	l	
00250	10	2

PL System poziomowania płytek
GB Tile leveling system
D Fliesen-Ausgleichssystem
RUS Система выравнивания плитки-зажим СВП
CZ Dlaždice nivelační systém
RO Sistemul de nivelare plăci
H Csempé szintező rendszer
E Sistema de nivelación del azulejo

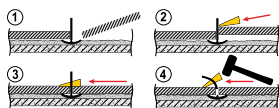
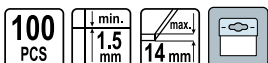

30x30	33x33	40x40	45x45	50x50	60x60	80x80	60x30	100x50	120x60
42	36	20	28	24	10	10	22	16	10

number of clips and wedges for various dimensions tiles per 1m² / Ilość klinów na 1m² w zależności od rozmiaru płytki:



No.	pcs	
04690	100	15

PL Gąbka glazurnicza hydrochlonna
GB Hygroscopic glazing sponge
D Wasserabsaugender Fliesenschwamm
RUS Губка для затирки плитки

CZ Houba na spárování obkladů nasákavá
RO Burete pt. plăci ceramice hidroabsorbant
H Nedvszívó csempézó szivacs
E Esponja para esmaltar higroscópica



No.	mm	
04542	170x110x60	56

PL Gąbka glazurnicza gumowa
GB Rubber glazing sponge
D Gummi-Fliesenschwamm
RUS Губка для затирки плитки

CZ Houba na spárování obkladů gumová
RO Burete pt. plăci ceramice de cauciuc
H Gumi csempézó szivacs
E Esponja para esmaltar de goma

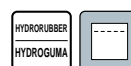

No.	mm	
04546	150x100x50	10

PL Szczypce do poziomowania płytek
GB Tile leveling floor pliers
D Nivelliersystem Zange
RUS Щипцы до системы нивелировки

CZ Kleště pro dlaždice vyrovnání
RO Cleste de nivelat gresie reglabil
H Lapszintező speciális fogó
E Tenaza para sistema de nivelación

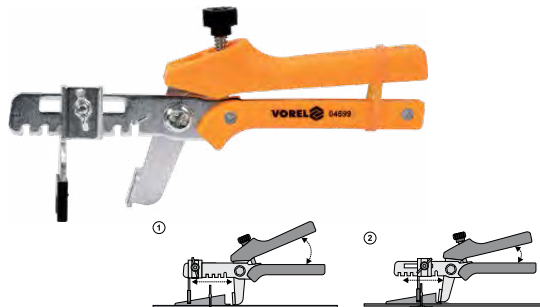
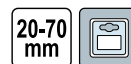

No.		
04699		5/30

PL System poziomowania płytek
GB Tile leveling system
D Fliesen-Ausgleichssystem
RUS Система выравнивания плитки-зажим СВП
CZ Dlaždice nivelační systém
RO Sistemul de nivelare plăci
H Csempé szintező rendszer
E Sistema de nivelación del azulejo

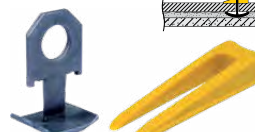
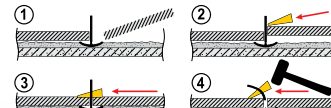

30x30	33x33	40x40	45x45	50x50	60x60	80x80	60x30	100x50	120x60
42	36	20	28	24	10	10	22	16	10

number of clips and wedges for various dimensions tiles per 1m² / Ilość klinów na 1m² w zależności od rozmiaru płytki:



No.	pcs	
04691	50+50	15

- PL System poziomowania płytek
- GB Tile leveling system
- D Fliesen-Ausgleichssystem
- RUS Система выравнивания плитки-зажим СВП
- CZ Dřáždice nivelační systém
- RO Sistemul de nivelare plăci
- H Csempe szintező rendszer
- E Sistema de nivelación del azulejoa

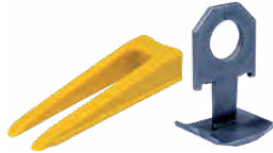
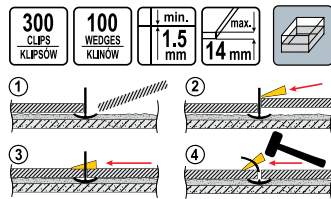

30x30	33x33	40x40	45x45	50x50	60x60	80x80	60x30	100x50	120x60
42	36	20	28	24	10	10	22	16	10

number of clips and wedges for various dimensions tiles per 1m² / Ilość klinów na 1m² w zależności od rozmiaru płytki:



No.	pcs	
04692	300+100	1

- PL Krzyżyki dystansowe
- GB Cross shape tile spacers
- D Fliesenkreuze
- RUS Крестики для плитки
- CZ Distanční křížky
- RO Distanțiere in cruce
- H Hézagoló kereszt
- E Crucetas para juntas



No.	mm	pcs	
04600	1.5	200	100
04610	2.0	200	100
04620	2.5	200	100
04630	3.0	150	100
04640	4.0	100	100
04650	5.0	100	100
04660	6.0	75	100
04668	8.0	30	100
04670	10.0	30	100

- PL Krzyżyki dystansowe
- GB Cross shape tile spacers
- D Fliesenkreuze
- RUS Крестики для плитки
- CZ Distanční křížky
- RO Distanțiere in cruce
- H Hézagoló kereszt
- E Crucetas para juntas

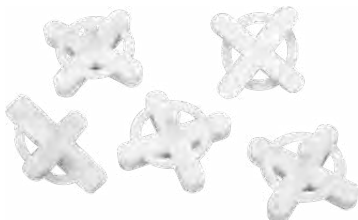

No.	mm	pcs	
04581	1.0	100	100
04582	1.5	100	100
04583	2.0	100	100
04584	2.5	100	100
04585	3.0	100	100
04586	4.0	75	100

- PL System poziomowania płytek
- GB Tile leveling system
- D Fliesen-Ausgleichssystem
- RUS Система выравнивания плитки-зажим СВП
- CZ Dřáždice nivelační systém
- RO Sistemul de nivelare plăci
- H Csempe szintező rendszer
- E Sistema de nivelación del azulejoa

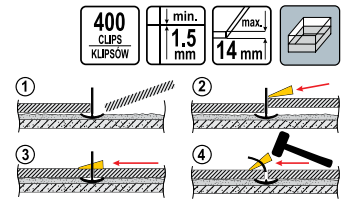

30x30	33x33	40x40	45x45	50x50	60x60	80x80	60x30	100x50	120x60
42	36	20	28	24	10	10	22	16	10

number of clips and wedges for various dimensions tiles per 1m² / Ilość klinów na 1m² w zależności od rozmiaru płytki:



No.	pcs	
04693	400	1

- PL Klíny do glazury
- GB Wedges for wall and floor tiles
- D Keile für Wand und Bodenfliesen
- RUS Клинья для плитки
- CZ Klíny do glazury
- RO Distanțiere faianta
- H Ék csempéhez
- E Cuñas para juntas de azulejos



No.	mm	pcs	
04700	23x4	100	100
04710	37x7	50	100

- PL Krzyżyki dystansowe
- GB Cross shape tile spacers
- D Fliesenkreuze
- RUS Крестики для плитки
- CZ Distanční křížky
- RO Distanțiere in cruce
- H Hézagoló kereszt
- E Crucetas para juntas



No.	mm	pcs	
04591	5.0	50	100
04592	6.0	50	100
04593	8.0	30	100
04594	10.0	30	100

PL Klamry do paneli ściennych CZ Přichytky do panelů
 GB Panel clamps RO Cleme (bride) pt. panouri
 D Klammern für Paneele H Kapcsok c panelekhez
 RUS Крепеж для панелей E Abrazaderas para paneles de paredes

100
PCS



No.	type	pcs	
04720	C-3	100	50
04721	C-1	100	50

PL Gazowa lampa lutownicza PIEZO CZ Płynová pájecí lampa
 GB Gas soldering lamp RO Lampă de lipit pe gaz
 D Gaslötlampe H Gázos forrasztólámpa
 RUS Лампа паяльная газовая с пьезоподжигом E Lampa de gas para soldar

PIEZO ELECTRIC 1200°C max. 1.7 kW
 123 g/h CARTRIDGE 190g BUTAN
 METAL COVER METALOWY KORPUS



No.	kW	
73403	1.7	12

PL Palnik gazowy CZ Plynový hořák
 GB Gas blow torch RO Arzator pe gaz
 D Lötbrenner H Gázégő
 RUS Газовая горелка E Soplețe de gas

0.22 kW PIEZO GAS BUTANE lighter gas BUTAN gaz do zapalniczki
 10 g CAPACITY POJEMNOŚĆ 30 min LOCK BLOKADA CHILD PROTECTION ZABEZPIECZENIE PRZED DZIECIAMI

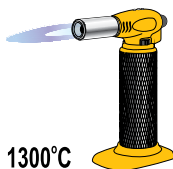

1300°C



No.	kW	
73420	0.22	10/60

PL Gazowa lampa lutownicza CZ Plynová pájecí lampa
 GB Gas soldering lamp RO Lampă de lipit pe gaz
 D Gaslötlampe H Gázos forrasztólámpa
 RUS Газовая паяльная лампа E Lampa de gas para soldar

1200°C max. 1.7 kW 123 g/h
 CARTRIDGE 190g BUTAN COMPOSITE BODY PLASTIKOWY KORPUS



No.	kW	
73400	1.7	12

PL Gazowa lampa lutownicza PIEZO CZ Płynová pájecí lampa
 GB Gas soldering lamp RO Lampă de lipit pe gaz
 D Gaslötlampe H Gázos forrasztólámpa
 RUS Лампа паяльная газовая с пьезоподжигом E Lampa de gas para soldar

PIEZO 850°C max. 1.7 kW
 123 g/h CARTRIDGE 190g BUTAN
 GAS GAZ METAL COVER METALOWY KORPUS

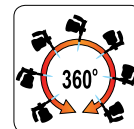

No.	kW	
73404	1.7	12

PL Lutownica gazowa 3 w 1 CZ Plynova pajka 3 in 1
 GB Soldering tool 3 in 1 RO Ciocan de lipit cu gaz 3 in 1
 D Gaslötkolben 3 in 1 H Gaz-forrasztópaka 3 in 1
 RUS Газовый паяльник 3-в-1 E Soldador de gas 3 in 1

15 ml 25~80 W 60 min
 BUTANE lighter gas BUTAN gaz do zapalniczki GAS GAZ PROPANE-BUTANE lighter gas PROPAN-BUTAN gaz do zapalniczki

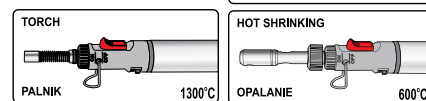
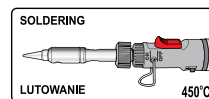

No.	W	
73410	25 - 80	12/48

PL Palnik gazowy CZ Plynový hořák
 GB Gas blow torch RO Arzator pe gaz
 D Lötbrenner H Gázégő
 RUS Газовая горелка E Soplete de gas

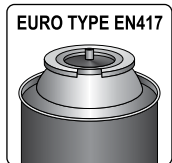

No.	kW	Box
73412	1.3	10/60

PL Zestaw do lutowania z dyszami
 GB Plumbers torch set with burners
 D Lötsatz
 RUS Набор для пайки
 CZ Souprava k letování
 RO Set pt. lipit
 H Forrasztó készlet
 E Juego para soldadura

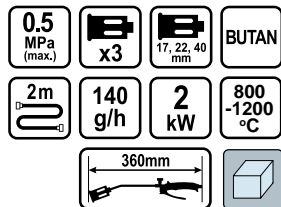

No.	MPa (max)	kW	L (mm)	Box
73325	0.5	2	360	20

PL Dysza do lutowania płomieni płaski CZ Dýza na letování, plochý plamen
 GB Flat nozzle RO Duză pt. lipit, flacără plată
 D Düse zum Löten, flache Flamme H Forrasztó égő, lapos láng
 RUS Конно плоское E Tobera para soldadura, llama plana



No.	size / rozmiar (mm)	Box
73331	40	50/250

PL Palnik gazowy CZ Plynový hořák
 GB Gas blow torch RO Arzator pe gaz
 D Lötbrenner H Gázégő
 RUS Газовая горелка E Soplete de gas

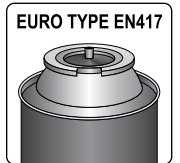

No.	kW	Box
73413	1.3	10/60

PL Dysza do lutowania płomieni punktowy CZ Dýza na letování, bodový plamen
 GB Point nozzle RO Duză pt. lipit, flacără punct
 D Düse zum Löten, Punktflamme H Forrasztó égő, szűrő láng
 RUS Сопло паяльника E Tobera para soldadura, llama de punta



No.	size / rozmiar (mm)	Box
73330	17	50/250

PL Palnik dekarški z dyszami
 GB Roof heating torch with burners
 D Dachdeckerbrenner
 RUS Кровельная горелка
 CZ Hořák pro pokrývače
 RO Arzator pt. acoperiş
 H Bádagos forrasztó készülék
 E Soplete de techado

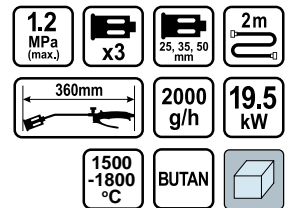

No.	MPa (max)	kW	L (mm)	Box
73340	1.2	19.5	360	10

- PL Palnik dekarski z dyszą i lancą
- GB Roof heating torch with burners
- D Dachdeckerbrenner
- RUS Кровельная горелка
- CZ Hořák pro rokvývače
- RO Arzător pt. acoperiș
- H Bádógos forrasztó készülék
- E Soplete de techado

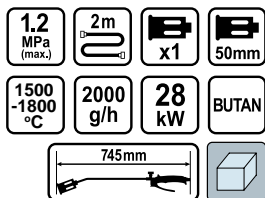

No.	MPa (max)	kW	L (mm)	Box
73341	1.2	28	745	20

- PL Palnik dekarski z dyszami i lancą
- GB Roof heating torch with burners
- D Dachdeckerbrenner
- RUS Кровельная горелка
- CZ Hořák pro rokvývače
- RO Arzător pt. acoperiș
- H Bádógos forrasztó készülék
- E Soplete de techado

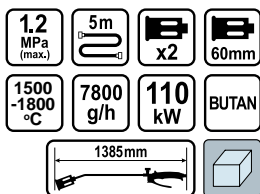

No.	MPa (max)	kW	L (mm)	Box
73343	1.2	110	1385	8

- PL Dysza
- GB Nozzle
- D Düse
- RUS Сопло
- CZ Dyža
- RO Duză
- H Fűvóka
- E Tobera



No.	Ø (mm)	Box
73350	25	25/50
73351	35	25/50
73352	50	50
73353	60	25/50

- PL Wąż przyłączeniowy do gazu
- GB Hose
- D Anschluss Schlauch für Gas
- RUS Шланг газоподводящий
- CZ Hadice k připojení plynu
- RO Furtun de conectare pt. gaz
- H Csatlakozó gáztömlő
- E Manguera de conexión de gas



No.	L (m)	Ø (mm)	Box
73360	2	8	20
73362	5	8	20

- PL Palnik dekarski z dyszą i lancą
- GB Roof heating torch with burners
- D Dachdeckerbrenner
- RUS Кровельная горелка
- CZ Hořák pro rokvývače
- RO Arzător pt. acoperiș
- H Bádógos forrasztó készülék
- E Soplete de techado

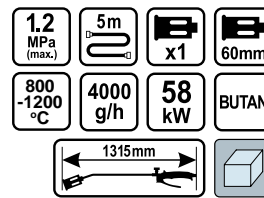

No.	MPa (max)	kW	L (mm)	Box
73342	1.2	58	1315	8

- PL Aluminiowa drabina teleskopowa
- GB Aluminium telescopic ladder
- D Teleskopleiter aus Aluminium
- RUS Многофункциональная стремянка
- CZ Hliníkový teleskopický žebřík
- RO Scară telescopică din aluminiu
- H Alumínium kúhúzható létra
- E Escalera telescópica de aluminio

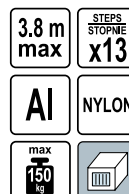

No.	height / wysokość (m)	number of steps / ilość stopni	Box
17701	3.8	13	1

- PL Aluminiowa drabina teleskopowa
- GB Aluminium telescopic ladder
- D Teleskopleiter aus Aluminium
- RUS Многофункциональная стремянка
- CZ Hliníkový teleskopický žebřík
- RO Scară telescopică din aluminiu
- H Alumínium kihúzható létra
- E Escalera telescópica de aluminio

3.8 m max	STEPS STOPNIE x13	max 150 kg
Al	NYLON	



3.8 m



1.06 m



2.5 cm



No. 17702

1

- PL Drabina 2-stopniowa rozkładana
- GB 2-step ladder
- D 2-Stufen-Leiter
- RUS 2-ступенчатая лестница
- CZ Schůdky 2 stupně
- RO Scări cu 2 trepte
- H 2 fokos lépcsők
- E 2 pasos escaleras



2 STEPS STOPNIE	90x47.5 x49 cm	99 cm FOLDED HIGH WYSOKOŚĆ ZŁOŻONEJ	38x26 cm STEP SIZE ROZMIAR STOPNIA
max 150 kg	ANTI-SLIP RUBBER PAD PODKLADKA ANTY-POŚLIZGOWA	PROTECTION RAIL WSPORNIK OCHRONNY	SOFT GRIP MIĘKKI UCHWYT



No. 17730

height / wysokość (m) 0.9

number of steps / ilość stopni 2

4

- PL Drabina wielofunkcyjna
- GB Multifold ladder
- D Mehrzweckleiter
- RUS Лестница многофункциональная
- CZ Multifunkční žebřík
- RO Scară multifuncțională
- H Többcéllú létra
- E Escalera multiproposito

3.4 m max	STEPS STOPNIE 4x3	16 kg	max 150 kg	
------------------	--------------------------	--------------	-------------------	--

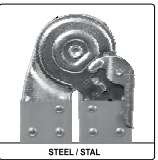
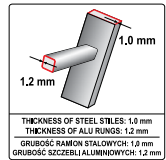
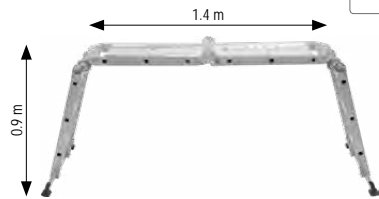

No. 17704

1

- PL Drabina 3-stopniowa rozkładana
- GB 3-step ladder
- D 3-Stufen-Leiter
- RUS 3-ступенчатая лестница
- CZ Schůdky 3 stupně
- RO Scări cu 3 trepte
- H 3 fokos lépcsők
- E 3 pasos escaleras



3 STEPS STOPNIE	115x47.5 x65 cm	125 cm FOLDED HIGH WYSOKOŚĆ ZŁOŻONEJ	38x26 cm STEP SIZE ROZMIAR STOPNIA
max 150 kg	ANTI-SLIP RUBBER PAD PODKLADKA ANTY-POŚLIZGOWA	PROTECTION RAIL WSPORNIK OCHRONNY	SOFT GRIP MIĘKKI UCHWYT



No. 17733

height / wysokość (m) 1.15

number of steps / ilość stopni 3

2

- PL Podest do drabiny wielofunkcyjnej
- GB Multifold ladder platform
- D Podest für die Multifunktionale Leiter
- RUS Подставки для стремянки
- CZ Plošina pro víceúčelový žebřík
- RO Platformă pt. scară multifuncțională
- H Palló a multifunkciós létrához
- E Descansillos para la escala multifuncional

830x295 mm	560x295 mm
ZINC PLATED OCYNKOWANE	ANTI-SLIP SURFACE ANTYPOŚLIZKIWA POMERZCHINA
max 150 kg	

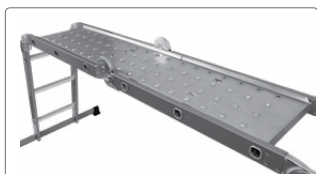
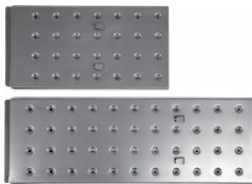

No.	for / dla	
17705	17704	5

- PL Podstawa robocza z metalu
- GB Saw horse
- D Stahl-Arbeitsbock
- RUS Опорный штатив
- CZ Opěrný kozlík
- RO Capre de lucru
- H Munkabak
- E Caballete de apoyo

2 PCS	100x10 x75 cm	max. 200kg
NON SLIP RUBBER WORKTOP GUMOWY BLAT ANTYPOŚLIZKIWA	GALVANIZED STEEL STAL OCYNKOWANA	HOLDER FOR CARRYING UCHWYT DO PRZENOSZENIA



No.		
29401		1

- PL Podpora z rolką
- GB Adjustable roller stand
- D Rollenbock
- RUS Роликовая опора
- CZ Opěrný stojan
- RO Stand cu role si suport
- H Felsőgörgős-bak
- E Caballete de apoyo con rodillo

68 mm ↓ 105 mm	60cm ROLLER ROLKA
max. 60 kg	GALVANIZED STEEL STAL OCYNKOWANA
CHROME ROLLER CHROMOWANA ROLKA	



No.		
29410		1

- PL Podstawa robocza z tworzywa
- GB Saw horse
- D Stahl-Arbeitsbock
- RUS Опорный штатив
- CZ Opěrný kozlík
- RO Capre de lucru
- H Munkabak
- E Caballete de apoyo

2 PCS	PP
TPR	ABS



No.		
29400		3

- PL Podstawa robocza z regulowaną wysokością
- GB Saw horse
- D Stahl-Arbeitsbock
- RUS Опорный штатив
- CZ Opěrný kozlík
- RO Capre de lucru
- H Munkabak
- E Caballete de apoyo

79 mm ↑ 130 mm	max. 200kg	GALVANIZED STEEL STAL OCYNKOWANA
----------------------	------------	--



No.		
29404		1

- PL Paca styropianowa
- GB Polystyrene plastering trowel
- D Styropor-Reibebrett
- RUS Тёрка пенопластовая
- CZ Polystyrénové hladítko
- RO Gletiera poliuretán
- H Habszivacs simító
- E Lana de polietileno

POLYSTYRENE STYROPIAN	
-----------------------	--



No.	mm	
06400	130x270	10
06410	140x500	10
06440	170x320	10

- PL Paca styropianowa
GB Polystyrene plastering trowel
D Styropor-Reibebrett
RUS Тёрка пенопластовая
- CZ Polystyrénové hladítko
RO Gletiera poliuretan
H Habszivacs simító
E Llana de polietileno

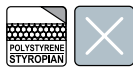

No.	mm	
06420	140x700	10
06430	140x1000	10

- PL Tarka do styropianu
GB Steel plastering trowel
D Reibebrett für Styropor
RUS Тёрка стальная нержавеющая
- CZ Ohnutá špachtle nerezavějící
RO Gletiera otel
H Spatula hajlított, rozsdamentes
E Espátula de acero inox curvo



No.	mm	
06470	270x130	20
06472	400x180	10

- PL Paca tynkarska filc
GB Plastering trowel
D Filzgläter
RUS Тёрка пластмассовая с войлочным покрытием
CZ Umělohmotné hladítko omítkářské z filcem
RO Gletiera PVC cu pasla
H Műanyag simító vakoláshoz, filccel
E Llana de plástico para enlucido con fieltro

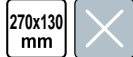

VOREL

No.	mm	felt thickness / grubość filcu (mm)	
06510	270x130	4	20

- PL Paca tynkarska gęsta gąbka
GB Plastering trowel
D Schwambrett
RUS Тёрка штукатурная с поролоновым покрытием (пластмассовая)
CZ Umělohmotné hladítko omítkářské z hustou houbou
RO Gletiera PVC cu burete dens
H Műanyag simító vakoláshoz, tömör szivacsal
E Llana de plástico para enlucido con esponja densa

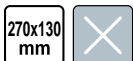

VOREL

No.	mm	sponge thickness / grubość gąbki (mm)	
06530	270x130	25	20

- PL Paca styropianowa kątowna
GB Polystyrene plastering trowel
D Fummelbrett aus Kunststoff
RUS Тёрка пенопластовая
- CZ Polystyrénové hladítko úhlové
RO Gletiera poliuretan unghiulara
H Habszivacs simító, derékszögű
E Llana de polietileno en angulo



No.	mm	
06401	80x340	10

- PL Paca tynkarska plastikowa
GB Plastic plastering trowel
D Glätekelle
RUS Гладилка пластиковая
- CZ Umělohmotné hladítko omítkářské
RO Gletiera PVC
H Műanyag simító vakoláshoz
E Llana de plástico para enlucido

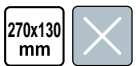

No.	mm	
06500	270x130	24

- PL Paca tynkarska miękka guma
GB Soft rubber plastering trowel
D Gummireibebrett
RUS Тёрка пластмассовая с резиновым покрытием
CZ Umělohmotné hladítko omítkářské z měkkou gumou
RO Gletiera PVC cu cauciuc
H Műanyag simító vakoláshoz, lágy gumival
E Llana de plástico para enlucido con goma suave



VOREL

No.	mm	rubber thickness / grubość gumy (mm)	
06520	270x130	4	30

- PL Paca tynkarska rzadka gąbka
GB Plastering trowel
D Schwambrett
RUS Тёрка штукатурная с поролоновым покрытием (пластмассовая)
CZ Umělohmotné hladítko omítkářské z řídkou houbou
RO Gletiera PVC cu burete rar
H Műanyag simító vakoláshoz, lágy szivacsal
E Llana de plástico para enlucido con esponja poco densa



VOREL

No.	mm	sponge thickness / grubość gąbki (mm)	
06540	270x130	25	20

PL Paca tynkarska metalowa nierdzewna
GB Stainless steel plastering trowel
D Schweizer Glätte
RUS Гладилка нержавеющей гладкая
CZ Hladitko omitkářské nerezavějící
RO Gletiera inox
H Rozsdamentes simító vakoláshoz
E Llana para enlucido acero inox. llano



VOREL

No.	mm	
06640	380x128	10
06660	480x128	10
06680	580x128	18

PL Paca tynkarska metalowa nierdzewna
GB Stainless steel plastering trowel
D Glättekelle
RUS Гладилка нержавеющей с пластмассовой ручкой
CZ Hladitko omitkářské nerezavějící
RO Gletiera inox maner plastic
H Rozsdamentes simító vakoláshoz
E Llana para enlucido acero inox. llano



VOREL

No.	mm	
06700	270x125	24

PL Paca tynkarska metalowa nierdzewna
GB Stainless steel plastering trowel
D Glättekelle gezahnt
RUS Гладилка нержавеющей зубчатая

CZ Hladitko omitkářské nerezavějící
RO Gletiera inox
H Rozsdamentes simító vakoláshoz
E Llana para enlucido acero inox. llano



VOREL

No.	mm	teeth / zęby (mm)	
06740	270x125	4x4	24
06760	270x125	6x6	24
06780	270x125	8x8	24
06781	270x125	10x10	24

PL Paca plastikowa z gąbką nacinaną
GB Plastic float with incised sponge
D Reibebrett aus Kunststoff, mit aufgeschnittenem Schwamm
RUS Пластиковый шпатель с надрезной губкой
CZ Plastové hladitko s narezanou houbou
RO Netezitoare din plastic cu burete tăiat
H Műanyag simító, szivacsos
E Llana de plástico con esponja entallada



VOREL

No.	L (mm)	sponge thickness / grubość gąbki (mm)	
06532	270x130	30	20

PL Paca tynkarska metalowa nierdzewna
GB Stainless steel plastering trowel
D Schweizer Glätte gezahnt
RUS Гладилка металлическая зубчатая
CZ Hladitko omitkářské nerezavějící
RO Gletiera inox
H Rozsdamentes simító vakoláshoz
E Llana para enlucido acero inox. llano



VOREL

No.	mm	teeth / zęby (mm)	
06650	380x128	8x8	10
06670	480x128	8x8	10
06690	580x128	8x8	18

PL Paca tynkarska metalowa nierdzewna, podstawa aluminium
GB Stainless steel plastering trowel
D Glättekelle
RUS Гладилка стальная нержавеющей гладкая
CZ Hladitko omitkářské nerezavějící
RO Gletiera inox
H Rozsdamentes simító vakoláshoz
E Llana para enlucido acero inox. llano



VOREL

No.	mm	
06701	270x130	24

PL Paca miękka z gumą do fugowania
GB Float with soft rubber
D Weiches Reibebrett mit Gummi zum Verfugen
RUS Терка для затирки швов

CZ Hladitko měkké s gumou na spárování
RO Pac moale cu cauciuc pt. cimentare
H Fugázó simító puha gumiival
E Llana suave con goma para rejuntar



VOREL

No.	mm	
06512	260x95	12

PL Paca plastikowa z hydrogumą
GB Plastic float with hydorrubber
D Reibebrett aus Kunststoff, mit Hydrogummi
RUS Терка шлифовальная с мягкой губчатой накладкой
CZ Plastové hladitko s pěnovou gumou
RO Netezitoare din plastic cu hidrocauciuc
H Műanyag simító, durva szivacsos
E Llana de plástico con hidrocaucho



VOREL

No.	L (mm)	rubber thickness / grubość gumy (mm)	
06537	270x130	9	20
06538	270x130	18	20

- PL Kielnia trójkątna CZ Zednická lížice trojúhelníková
 GB Brick trowel RO Mistrie triunghiulară
 D Spitzkelle H Háromszög vakolókanál
 RUS Кельма треугольная E Paleta triangular



No.	mm	☐
06340	180	50
06350	200	50
06360	220	50

- PL Kielnia trapezowa nierdzewna
 GB Stainless steel brick trowel
 D Stukkaturkelle
 RUS Кельма шпательная нержавеющая
 CZ Lichoběžníková zednická lížice nerezavějící
 RO Mistrie trapezoidală inoxidabilă
 H Trapéz vakolókanál, rozsdamentes
 E Paleta trapezoidal de acero inox.



No.	mm	☐
06370	130	50
06380	180	30

- PL Tynkownica pneumatyczna do ścian
 GB Plaster / stucco spray gun
 D Spritzpistole für Mörtel
 RUS Пневмоковш для штукатурки стен
 CZ Stříkací pistole pro maltu
 RO Spray pistol pt. mortar
 H Habarcs szórópisztoly
 E Pistola pulverizadora para mortero



$L_{pA} = 91,8 \pm 2,5$ dB; $L_{wA} = 102,8 \pm 2,5$ dB; $a_n = < 2,5$ m/s²

No.	l / min	☐
09900	400	4

- PL Kielnia do betonu komórkowego
 GB Trowel for areated blocks
 D Kelle für Porenbeton
 RUS Кельма для газобетона
- CZ Zednická lížice na pórobeton
 RO Mistrie pt. bca
 H Habarcszerítő kanál sejt betonhoz
 E Allanadora para hormigón celular



No.	mm	☐
05801	100	10
05802	115	10
05803	125	10
05804	200	10
05805	240	10
05806	300	10
05807	365	10

- PL Kielnia trójkątna nierdzewna
 GB Stainless steel brick trowel
 D Spitzkelle
 RUS Кельма треугольная нержавеющая
 CZ Zednická lížice trojúhelníková nerezavějící
 RO Mistrie triunghiulară inoxidabilă
 H Háromszög vakolókanál, rozsdamentes
 E Paleta triangular de acero inox.



No.	mm	☐
06341	180	50
06351	200	30

- PL Kielnia sztukatorska, podkowa CZ Ohnutá špachtle nerezavějící
 GB Stainless steel scraper RO Spaclu indoit inoxidabil
 D Stukkateurspachtel H Spatula hajlítot, rozsdamentes
 RUS Кельма штукатурная E Espotula de acero inox curvo



No.	mm	☐
06110	60x110	50
06120	80x120	50

- PL Tynkownica pneumatyczna do sufitów
 GB Ceiling plaster / stucco spray gun
 D Deckenplatte / Stucco Spritzpistole
 RUS Пневмоковш для штукатурки потолков
 CZ Stříkací pistole pro maltu
 RO Spray pistol pt. mortar
 H Habarcs szórópisztoly
 E Pistola pulverizadora para mortero

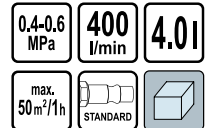

$L_{pA} = 94,9 \pm 2,5$ dB; $L_{wA} = 105,9 \pm 2,5$ dB; $a_n = < 2,5$ m/s²

No.	l / min	☐
09903	400	4



- PL Wiertło do bloczków CZ Vrták do kvádrů
 GB Borer for aerated blocks RO Sfredel pt. bca
 D Bohrer für Porenbeton H Falfűró
 RUS Сверло по газобетону E Taladro para bloques



No.	mm	
05821	60	20
05822	80	20
05823	120	20

- PL Zdzierak wyrównujący z ząbkami
 GB Scraper with teeth for plaster and aerated blocks
 D Ausgleichbrett mit Zähnen
 RUS Скребок-рубанок для газобетона зубчатый
 CZ Vyrovňovací škrabák se zoubky
 RO Drișcă nivelare cu dinți
 H Fogas, kiegyenlítő dörzsölő
 E Raspador con dientes

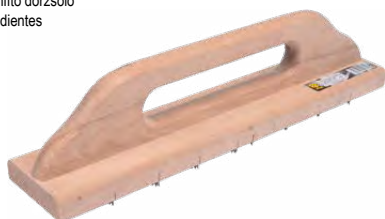

No.	mm	
05831	80x400	10

- PL Rylec do betonu komórkowego CZ Drážkovač na pórobeton
 GB Grooving device for aerated concrete RO Dispozitiv canelat bca
 D Werkzeug für Porenbeton boh rung H Horonymaró sejtbetonhoz
 RUS Штроборез по газобетону E Cincel para hormigón celular



No.		
05850		10

- PL Uchwyt do przenoszenia płyt G/K CZ Držák pro přenášení desek s rukojetí
 GB Drywall panel carrier RO Dispozitiv pt. transportat plac de gips-carton
 D Plattenträger mit Tragegriff H Jellemzők és előnyök
 RUS Приспособление для переноски плит E Empunadura porta-placas

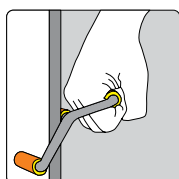

No.		
04755		6/12

- PL Zdzierak wyrównujący
 GB Scraper for plaster and aerated blocks
 D Schaber Gipskartonplatten und belüftete Blöcke
 RUS Скребок-рубанок, зубчатый
 CZ Vyrovňací škrabák
 RO Gletiera lem pt. tencuieli
 H Kiegyenlítő dörzsölő
 E Raspador



No.	mm	
05830	80x400	10

- PL Przymiar do cięcia pod kątem
 GB Template tool for aerated blocks cut
 D Werkzeug für Porenbeton schneiden
 RUS Угольник для резки газобетона
 CZ Pravítko k řezání pod úhlem
 RO Dispozitiv pt. taiat bca
 H Gérvágó tok
 E Calibre de comprobación para cortes angulares



No.		
05840		4

- PL Stalowa dźwignia do unoszenia płyt CZ Ocelový nožní zvedák na desky
 GB Steel drywall board lifter RO Dispozitiv ridicare placi rigips
 D Stahlhebel zum Anheben der Platten H Acél kar a lapok felemeléséhez
 RUS Ножной рычаг для подъема листовых материалов E Palanca de acero para la elevación de placas



No.		
04750		6/24

- PL Pila do gazobetonu CZ Pila pro plynobeton
 GB Saw for gas concrete RO Fierastrau cu placute vidia pt. BCA
 D Gasbetonsäge H Fűrész gázbetonhoz
 RUS Пила по газобетону с твердосплавным зубом E Sierra para gas hormigon



No.	L (mm)	teeth / zęby	
28000	600	33/33	5
28010	600	33/17	5

- PL Pila do gazobetonu
 GB Saw for gas concrete
 D Gasbetonsäge
 RUS Пила по газобетону с твердосплавным зубом
- CZ Pila na plynobeton
 RO Fierastrau cu placute vidia pt. beton
 H Fűrész gázbetonhoz
 E Sierra para gas hormigon



No.	L (mm)	teeth / zęby	
28011	600	15	6/12
28012	660	34	6/12

- PL Komplet szpachelek
 GB Scraper set
 D Malerspachtelsatz
 RUS Набор шпателей
- CZ Špachtle
 RO Șpaclu
 H Malerspachtelsatz
 E Espatulas

3 PCS
 30 mm
 50 mm
 80 mm



No.	mm	pcs	
06130	30; 50; 80	3	25/100

- PL Szpachle japońskie plastikowe
 GB Plastic japonese putty knife
 D Japanspachtelsatz Kunststoff
 RUS Пластиковые шпатели „ЯПОНКИ”
- CZ Japonské špachtle
 RO Set spaclu plastic
 H Spakli készlet
 E Triuso espátula japonesa

4 PCS
 50 mm
 75 mm
 100 mm
 120 mm



No.	mm	pcs	
05950	50; 75; 100; 120	4	10

- PL Szpachelka
 GB Scraper
 D Malerspachtel
 RUS Шпатель
- CZ Špachtle
 RO Șpaclu
 H Spatula
 E Espatula



No.	mm	
06030	30	12/240
06040	40	12/240
06050	50	12/240
06060	60	12/240
06080	80	12/240
06100	100	12/240

- PL Szpachelka kątowa wewnętrzna
 GB Stainless steel scraper
 D Kelle für Innenecken
 RUS Кельма для внутренних углов
- CZ Úhlová špachtle vnitřní
 RO Șpaclu unghiular interior
 H Belsőél kanál
 E Paleta en angulo

80x60x60 mm
 SS
 STAINLESS STEEL
 ÉTEL, NEFÉZŐVÁNY



No.	mm	
06150	80x60x60	50

- PL Szpachelki „japonki” nierdzewne
 GB Stainless steel scraper set
 D Aufstreichspachtel
 RUS Набор шпателей нержавеющей тип „японский”
- CZ Špachtle japonsky nerezavějící
 RO Spaclu japonez inox set
 H Spatula rozsdamentes
 E Espatulas „japonesas” de acero inox

4 PCS
 50 mm
 80 mm
 100 mm
 120 mm



No.	mm	pcs	
06290	50; 80; 100; 120	4	12/120

- PL Szpachla malarska nierdzewna CZ Malińska špachtle nerezavějici
 GB Stainless steel putty knife RO Spaciu de chituit, inox, maner plastic
 D Glasurzange H Rozsdamentes festőspatula
 RUS Шпатель фасадный E Espátula de pintura, de acero inox



No.	mm	
06294	40	100
06295	60	80
06296	80	60
06297	100	50
06298	150	80
06301	200	60
06304	250	50
06307	350	25
06308	450	25
06309	600	10

- PL Pace plastikowe do kleju
 GB Plastic putty knives for glue
 D Kunststoffspachtel gezahnt
 RUS Пластиковые шпатели для плиточного клея
 CZ Zubová stěrka plastová
 RO Spatula zimtata
 H Műanyag spakli
 E Espátula de plástico

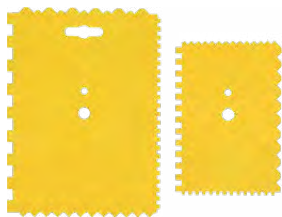

No.	mm	pcs	
05960	180x130; 130x90	2	10

- PL Szpachla plastikowa z zębami
 GB Plastic putty knife with teeth
 D Spachtel Kunststoff
 RUS Шпатель пластмассовый, зубчатый
 CZ Plastové čtyřhranné zuby
 RO Spatula dintata
 H Fogazott műanyag spatulya
 E Espátula de plástico con dientes



No.	mm	teeth / zęby (mm)	
05972	225	6x6	50

- PL Szpachle plastikowe CZ Sada univerzálních stěrek
 GB Plastic putty knife set RO Set spaciu plastic
 D Kunststoffspatel H Spakli készlet
 RUS Шпатели пластиковые E Set espátula de plástico



No.	mm	pcs	
05980	40; 60; 80; 100	4	30

- PL Szpachla nierdzewna CZ Špachtle nerezavějici
 GB Stainless steel putty knife RO Spaciu de chituit, inox, maner plastic, crestat
 D Kleberspachtel H Rozsdamentes spatula
 RUS Шпатель фасадный зубчатый E Espátula de acero inox.



No.	mm	teeth / zęby (mm)	
06299	150	6x6	80
06300	150	8x8	80
06302	200	6x6	60
06303	200	8x8	60
06305	250	6x6	50
06306	250	8x8	50

- PL Szpachla plastikowa gładka
 GB Plastic smooth putty knife
 D Spachtel Kunststoff
 RUS Шпатель прямой пластмассовый
 CZ Plastové rovné
 RO Spatula dintata
 H Műanyag spakli
 E Espátula de plástico



No.	mm	
05971	225	50

- PL Szpachla plastikowa z zębami trójkątnymi
 GB Plastic putty knife with truncated teeth
 D Spachtel Kunststoff
 RUS Шпатель пластмассовый, зубчатый
 CZ Plastové trojúhelníkové zuby
 RO Spatula dintata
 H Fogazott műanyag spatulya
 E Espátula de plástico con dientes



No.	mm	teeth / zęby (mm)	
05973	225	7	50

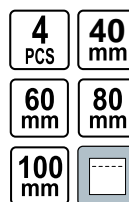

PL Szpachla gumowa do fugowania CZ Pryżová špachtle na fugování
 GB Rubber grout spreader RO Spaclu cauciucat pt. rosturi
 D Gummispachtel H Fugázógumi
 RUS Шпатель резиновый для фуговки E Espátula de goma para rejuntar



No.	mm	
06310	150	30
06320	200	30
06330	250	30
06331	300	30

PL Szpachelka nierdzewna CZ Špachtle
 GB Stainless steel scraper RO Špaclu
 D Rostfrei Spachtel H Spatula
 RUS Шпатель нержавеющей E Espátula de acero inox



No.	mm	
05911	30	6/72
05912	40	6/72
05913	50	6/72
05914	60	6/72
05915	80	6/72
05916	100	6/72

PL Skrobak malarski CZ Škrabka malířská
 GB Painting scraper RO Răzuitor pt. zugrăvi
 D Malerabkratzer H Festékvakaró
 RUS Скребок для краски со сменным лезвием E Rascador de pintor



No.	blade / ostrze L (mm)	
06795	100	60

PL Szpachelka nierdzewna CZ Špachtle
 GB Stainless steel scraper RO Špaclu
 D Rostfrei Spachtel H Spatula
 RUS Шпатель нержавеющей E Espátula de acero inox



No.	mm	
05901	30	6/72
05902	40	6/72
05903	50	6/72
05904	60	6/72
05905	80	6/72
05906	100	6/72

PL Szpachelka nierdzewna wygięta CZ Špachtle
 GB Stainless steel scraper RO Špaclu
 D Rostfrei Spachtel H Spatula
 RUS Шпатель нержавеющей изогнутый E Espátula de acero inox curvo



No.	mm	
05921	30	6/72
05922	40	6/72
05923	50	6/72
05924	60	6/72
05925	80	6/72
05926	100	6/72

PL Skrobak malarski CZ Škrabka malířská
 GB Painting scraper RO Răzuitor pt. zugrăvi
 D Malerabkratzer H Festékvakaró
 RUS Скребок для удаления краски E Rascador de pintor



No.	W (mm)	
06797	115	50

- PL Ostrze do skrobaka 06795
 GB Spare blades for 06795
 D Schneide für 06795
 RUS Сменные лезвия для скребка 06795
- CZ Ostří do škrabky
 RO Tăiş pt. răzuitor
 H Festékvakaró-pengék
 E Filo para rascador

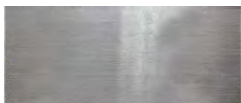

No.	for / dla	pcs	
06796	06795	5	10/100

- PL Skrobak do szyb i uszczelek
 GB Scraper for glass and gaskets
 D Schaber für Glas und Dichtungen
 RUS Скребок для стекла и прокладки
- CZ Škrabka na sklo
 RO Răzuitor
 H Kaparó eszköz
 E Rasqueta

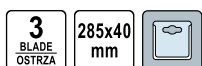

No.		
06790		6/36

- PL Skrobak do betonu bez trzonkiem
 GB Scraper for concrete floor
 D Betonschaber
 RUS Скребок напольный для бетона
- CZ Škrabka
 RO Răzuitor
 H Kaparó
 E Raspador obra suel



No.	blade size / rozmiar ostrza (mm)	
05760	120x350	12/24
05761	120x250	12/24

- PL Wymienne ostrze do skrobaka do betonu
 GB Blade for scraper
 D Klinge für Betonschaber
 RUS Лезвие к скребку для бетонного пола
- CZ Škrabka vyměnitelná čepel
 RO Lamă de schimb
 H Kaparó cserélhető penge
 E Răzuitor lamă de schimb



No.	blade size / rozmiar ostrza (mm)	
05773	150x250	25/50
05774	150x350	25/50

- PL Skrobak teleskopowy
 GB Telescopic scraper
 D Teleskop Schaber
 RUS Скребок телескопический
- CZ Teleskopický stěrač
 RO Razuitor flexibil
 H Teleszkópos jégkaparó
 E Telescópico raspador



No.		
06799		100

- PL Skrobak do betonu z trzonkiem
 GB Scraper for concrete floor
 D Betonschaber
 RUS Скребок напольный для бетона
- CZ Škrabka
 RO Răzuitor
 H Kaparó
 E Raspador obra suel



No.	blade size / rozmiar ostrza (mm)	L (mm)	
05750	75x200	1300	10
05751	75x300	1300	10
05752	75x400	1300	10

- PL Wymienne ostrze do skrobaka do betonu
 GB Blade for scraper
 D Klinge für Betonschaber
 RUS Лезвие к скребку для бетонного пола
- CZ Škrabka vyměnitelná čepel
 RO Lamă de schimb
 H Kaparó cserélhető penge
 E Răzuitor lamă de schimb

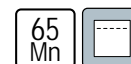

No.	blade size / rozmiar ostrza (mm)	
05770	100x200	25/50
05771	100x300	25/50
05772	100x400	25/50

- PL Czerpak murarski
 GB Mason's pan
 D Gipspfännchen
 RUS Ковш штукатурный
- CZ Zednický koreček
 RO Cancloc
 H Kőműveskanál
 E Achicador de albanil

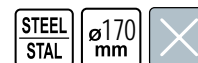

No.		
06335		50

PL Sito budowlane
GB Building strainer
D Bau Sieb
RUS Сито строительное

CZ Prohazovací síto stavební
RO Sita construcții
H Építőipari rosta
E Cedazo para construcción



No.	cm	size of eyelet / rozmiar oczka (mm)	
34944	60x100	4	30
34945	60x100	6	5/30
34946	60x100	8	5/30
34947	60x100	10	30

PL Mieszadło do zapraw i klejów
GB Mixer for compound and glue
D Wendelrührer
RUS Мешалка для клеевой массы и цемента

CZ Míchadlo na malty a lepidla
RO Agitator pt. mortar și cleiuri
H Habarcs és ragasztó keverő
E Mezcladora para morteros y pegamientos



No.	mm	
09010	90x510	40

PL Mieszadło do gipsu i gładzi
GB Mixer for gypsum and coat
D Gips- und Wachsührer
RUS Мешалка для гипса

CZ Míchadlo na sádku a stěrku
RO Agitator pt. ipsos și honuituri
H Gipsz és glett keverő
E Mezcladora para yeso



No.	mm	type	
09025	75x370	C-75	20

PL Mieszadło do farbu
GB Paint mixer
D Farbmischer
RUS Мешалка для краски

CZ Míchadlo na hmoty
RO Mixer vopsea / var
H Keverő festékekhez
E Mezclador para pinturas



No.	mm	
09060	60x400	40/80
09080	85x400	40/80
09090	100x600	30

PL Mieszadło do zapraw i klejów
GB Mixer for compound and glue
D Wendelrührer
RUS Мешалка для клеевой массы и цемента

CZ Míchadlo na malty a lepidla
RO Agitator pt. mortar și cleiuri
H Habarcs és ragasztó keverő
E Mezcladora para morteros y pegamientos



No.	mm	
09005	65x410	40
09006	80x410	40

PL Mieszadło do gipsu i gładzi
GB Mixer for gypsum and coat
D Gips- und Wachsührer
RUS Мешалка для гипса

CZ Míchadlo na sádku a stěrku
RO Agitator pt. ipsos și honuituri
H Gipsz és glett keverő
E Mezcladora para yeso



No.	mm	
09015	80x400	40
09017	100x555	20

PL Mieszadło do mas
GB Mixer for compound
D Rührer für Materialien auf Bitumenbasis
RUS Мешалка для штукатурки

CZ Míchadlo na stavební hmoty
RO Agitator pt. mase
H Keverő masszához
E Mezcladora para masas



No.	mm	
09044	80x400	25
09046	100x600	25

PL Mieszadło do mas
GB Mixer for compound
D Rührer für Materialien auf Bitumenbasis
RUS Мешалка для штукатурки

CZ Míchadlo na stavební hmoty
RO Agitator pt. mase
H Keverő masszához
E Mezcladora para masas



No.	mm	type	
09048	75x400	C-75	20
09049	85x450	C-85	20
09050	100x500	C-100	20
09051	110x550	C-110	20

PL Mieszadło do materiałów sypkich
GB Mixer for loose materials
D Mischer
RUS Мешалка для гипса

CZ Míchadlo na sypké materiály
RO Agitator pt. materiale vârsătoare
H Keverő szóródó anyagokhoz
E Mezcladora para materiales sueltos



No.	mm	
09028	80x400	35

PL Mieszadło
GB Mixer
D Rondenrührer
RUS Мешалка для штукатурки

CZ Míchadlo
RO Mixer
H Keverő
E Mezcladora



No.	mm	type	
09094	120x600	C-120	10

PL Mieszadło turbo z gwintem
GB Turbo threaded stirrer
D Turbomischer mit Gewinde
RUS Мешалка с нарезкой

CZ Míchadlo turbo se závitem
RO Dispozitiv de amestecat turbo cu filet
H Menetes, turbó keverő
E Turbo mezcladora con rosca



No.	mm	type	
09063	115x580	M14	10
09065	135x580	M14	10

PL Mieszadło do mas
GB Mixer for compound
D Rührer für Materialien auf Bitumenbasis
RUS Мешалка для штукатурки

CZ Míchadlo na stavební hmoty
RO Agitator pt. mase
H Keverő masszához
E Mezcladora para masas



No.	mm	
09054	80x400	25
09056	100x600	25

PL Mieszadło do mas
GB Mixer for compound
D Mörtel Mischer
RUS Мешалка для штукатурки

CZ Míchadlo na stavební hmoty
RO Agitator pt. mase
H Keverő masszához
E Mezcladora para masas



No.	mm	
09036	60x400	60
09038	80x400	35
09040	100x600	30

PL Mieszadło cynkowane SDS
GB Mixer
D Rondenrührer
RUS Мешалка для штукатурки

CZ Míchadlo
RO Mixer
H Keverő
E Mezcladora



No.	mm	
09096	80x400	20
09097	100x500	20

PL Walek do odpowietrzania
GB Deaeration roller
D Entlüftungsrolle
RUS Валик азрационный
CZ Váleček na odvdzušňování
RO Rola pt. modelare sapa
H Levegőkinyomó henger
E Rodillo para hacer el vacío



No.	mm	
06450	75x230	15
06452	123x230	10

- PL Walek do odpowietrzania CZ Váleček na odvzdušňování
 GB Deaeration roller RO Rola pt. modelare sapa
 D Entlüftungsrolle H Levegőkinyómó henger
 RUS Валик азраціонный E Rodillo para hacer el vacío



No.	mm	
06453	110x500	6

- PL Walek malarski Girpaint CZ Malířský váleček Girpaint
 GB Paint roller Girpaint RO Trafalet cu fir galben
 D Malerroller Girpaint H Festöhenger Girpaint
 RUS Валик полиакрил в сборе E Rodilli de pintura Girpaint



No.	roller width / szerokość wałka W (mm)	cover pile height / wysokość poszycia A (mm)	hole diameter / średnica otworu na uchwyt Ø (mm)	
09334	100	9	6	40
09336	180	18	6	60

- PL Walek malarski Flok CZ Malířský váleček
 GB Paint roller Flok RO Trafalet burete fin
 D Malerroller Flok H Festöhenger
 RUS Валик в сборе мольтопреп E Rodilli de pintura

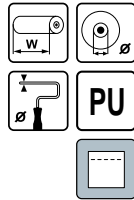

No.	roller width / szerokość wałka W (mm)	roller diameter / średnica wałka (mm)	hole diameter / średnica otworu na uchwyt Ø (mm)	
09359	150	50	6	50

- PL Walek malarski Moltopren CZ Malířský váleček
 GB Paint roller Moltopren RO Trafalet Burete cu tija plastic
 D Malerroller Moltopren H Festöhenger
 RUS Валик в сборе поролон E Rodilli de pintura

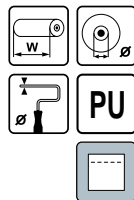

No.	roller width / szerokość wałka W (mm)	roller diameter / średnica wałka (mm)	hole diameter / średnica otworu na uchwyt Ø (mm)	
09371	70	35	6	80
09372	100	35	6	70
09373	150	50	6	50

- PL Walek malarski Syntex
 GB Paint roller Syntex
 D Malerroller Syntex
 RUS Валик в сборе полиакрил
 CZ Malířský váleček
 RO Trafalet Syntex
 H Festöhenger
 E Rodilli de pintura

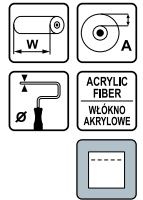

No.	roller width / szerokość wałka W (mm)	cover pile height / wysokość poszycia A (mm)	hole diameter / średnica otworu na uchwyt Ø (mm)	
09307	180	20	6	55
09308	250	20	6	50

- PL Walek malarski Vestan
 GB Paint roller Vestan
 D Malerroller
 RUS Валик в сборе, полиакрил
 CZ Malířský váleček
 RO Trafalet lana artificiala
 H Festöhenger
 E Rodilli de pintura

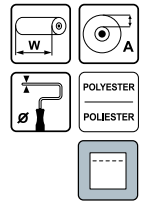

No.	roller width / szerokość wałka W (mm)	cover pile height / wysokość poszycia A (mm)	hole diameter / średnica otworu na uchwyt Ø (mm)	
09345	180	15	6	55
09346	250	15	6	50

- PL Walek malarski Moltopren CZ Malířský váleček
 GB Paint roller Moltopren RO Trafalet Burete cu tija plastic
 D Malerroller Moltopren H Festöhenger
 RUS Валик в сборе поролон E Rodilli de pintura

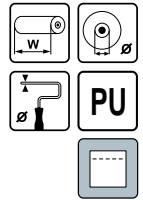

No.	roller width / szerokość wałka W (mm)	roller diameter / średnica wałka (mm)	hole diameter / średnica otworu na uchwyt Ø (mm)	
09370	50	35	6	70

- PL Zapas do wałka Multicolor CZ Náhradní váleček Multicolor
 GB Paint roller refill Multicolor RO Rezerva trafalet fir Multicolor
 D Maler-Ersatzwalzen Multicolor H Csere festöhenger Multicolor
 RUS Шубка полиамидовая для валика E Llana de polietileno Multicolor

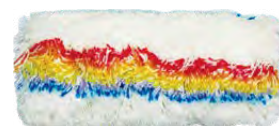
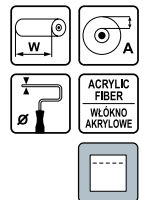

No.	roller width / szerokość wałka W (mm)	cover pile height / wysokość poszycia A (mm)	hole diameter / średnica otworu na uchwyt Ø (mm)	
09302	180	15	6	40
09303	250	15	8	25

- PL Zapas do walka Syntex
 GB Paint roller refill Syntex
 D Maler-Ersatzwalzen Syntex
 RUS Шубка полиакриловая для валика
- CZ Náhradní váleček Syntex
 RO Rezerva Trafalet Acril Verde
 H Csere festőhenger Syntex
 E Repuesto para el cilindro Syntex



VOREL

No.	roller width / szerokość walka W (mm)	cover pile height / wysokość poszycia A (mm)	hole diameter / średnica otworu na uchwyt Ø (mm)	
09310	180	20	6	10/40
09311	250	20	6	40

- PL Zapas do walka Girpaint
 GB Paint roller refill Girpaint
 D Maler-Ersatzwalzen Girpaint
 RUS Шубка полиамидная для валика
- CZ Náhradní váleček Girpaint
 RO Rezerva trafalet fir galben
 H Csere festőhenger Girpaint
 E Repuesto para el cilindro Girpaint



VOREL

No.	roller width / szerokość walka W (mm)	cover pile height / wysokość poszycia A (mm)	hole diameter / średnica otworu na uchwyt Ø (mm)	
09338	100	9	6	150

- PL Zapas do walka Moltopren
 GB Paint roller refill Moltopren
 D Maler-Ersatzwalzen Moltopren
 RUS Шубка мольтопрен
- CZ Náhradní váleček Moltopren
 RO Rezerve trafalet burete
 H Csere festőhenger Moltopren
 E Esponja de recambio

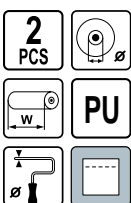

VOREL

No.	roller width / szerokość walka W (mm)	roller diameter / średnica walka (mm)	hole diameter / średnica otworu na uchwyt Ø (mm)	
09375	50	35	6	200
09377	100	35	6	90
09378	150	50	6	45

- PL Kratka malarska
 GB Painting grid
 D Farbenabrollgitter
 RUS Решетка малярная
- CZ Malířská mřížka
 RO Grătar pt. zugrăvit
 H Festőrács
 E Rejilla para pintar

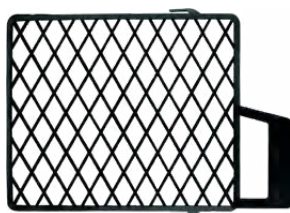

VOREL

No.	mm	
09413	265x285	100

- PL Zapas do walka
 GB Paint roller refill
 D Maler-Ersatzwalzen
 RUS Шубка нейлоновая для валика
- CZ Náhradní váleček
 RO Rezerva trafalet acril rosu
 H Csere festőhenger
 E Repuesto para el cilindro

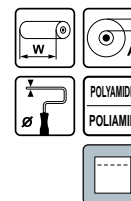

VOREL

No.	roller width / szerokość walka W (mm)	cover pile height / wysokość poszycia A (mm)	hole diameter / średnica otworu na uchwyt Ø (mm)	
09331	180	6	6	10/50
09332	250	6	8	10/40

- PL Zapas do walka Flok
 GB Paint roller refill Flok
 D Maler-Ersatzwalzen Flok
 RUS Шубка мольтопрен
- CZ Náhradní váleček Flok
 RO Rezerve trafalet burete fin
 H Csere festőhenger Flok
 E Esponja de recambio



VOREL

No.	roller width / szerokość walka W (mm)	roller diameter / średnica walka (mm)	hole diameter / średnica otworu na uchwyt Ø (mm)	
09363	50	35	6	75
09365	100	35	6	80

- PL Kuweta malarska
 GB Painting bowl
 D Malerschale
 RUS Ванночка малярная
- CZ Malířská květa
 RO Tava-suport trafalet
 H Kűvetta
 E Cuveta



VOREL

No.	mm	
09406	150x245	75
09408	330x350	50

- PL Walek malarski Vestan z kratką
 GB Paint roller set Vestan
 D Malerroller Vestan mit Abtropfgitter
 RUS Валик с решёткой
- CZ Malířský váleček + mřížka
 RO Trafalet cu grătar
 H Festőhenger + rács
 E Rodilli de pintura + rejilla



VOREL

No.	W (mm)	handle / uchwyt Ø (mm)	
09385	180	6	25

- PL Walek malarski Vestan z kufwą
GB Paint roller set Vestan
D Malerroller Vestan mit Malerschale
RUS Набор для покраски: ванночка, валик
- CZ Malířský váleček
RO Trafalet cu tava
H Festöhenger + küvette
E Rodillo de pelo + cubeta



No.	W (mm)	handle / uchwyt Ø (mm)	
09390	180	6	12

- PL Uchwyt do walka
GB Paint roller handle
D Malerroller-Griff
RUS Ручка для валика
- CZ Držák válečku
RO Maner trafalet
H Festöhenger nyél
E Mango del cilindro

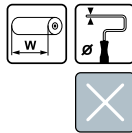

No.	roller width / szerokość walka W (mm)	hole diameter / średnica otworu na uchwyt Ø (mm)	
09421	50/70	6	90
09422	100	6	90
09425	150	6	150
09427	180	6	110
09429	250	6	110
09430	250	8	80

- PL Pędzel angielski profesjonalny
GB Flat paint brush
D Flachpinsel
RUS Кисть флейцевая
- CZ Anglický štětec
RO Pensulă englezească profesională
H Profesionális laposecset
E Brocha plana prof.



No.	brush width / szerokość pędzla W (mm)	bristle length / długość włosia (mm)	
09531	25	51/46	50
09532	36	51/46	50
09533	50	57/52	50
09534	62	57/52	50
09535	75	57/52	50
09536	87	64/59	50
09537	102	64/59	50

- PL Walek malarski Moltopren z kufwą
GB Paint roller set Moltopren
D Malerroller Moltopren mit Malerschale
RUS Набор для покраски: ванночка, валик
- CZ Malířský váleček + kyveta
RO Trafalet cu tava
H Festöhenger + küvette
E Rodillo esponja + cubeta



No.	W (mm)	handle / uchwyt Ø (mm)	
09395	50	6	60

- PL Pędzel angielski
GB Flat paint brush
D Flachpinsel
RUS Кисть флейцевая
- CZ Anglický štětec
RO Pensulă englezească
H Laposecset
E Brocha plana



No.	brush width / szerokość pędzla W (mm)	bristle length / długość włosia (mm)	
09521	25	44/39	50
09522	36	51/46	50
09523	50	51/46	50
09524	63	51/46	50
09525	76	51/46	50

- PL Pędzel kaloryferowy
GB Angled paint brush
D Heizkörperpinsel
RUS Кисть радиаторная
- CZ Štětec na topná tělesa
RO Pensulă pt. calorifere
H Radiátorecset
E Brocha angulada de radiadores



No.	brush width / szerokość pędzla W (mm)	bristle length / długość włosia (mm)	
09560	25	44/39	50
09561	36	51/46	50
09562	50	51/46	50

- PL Pędzel okrągły
GB Round paint brush
D Ringpinsel
RUS Кисть круглая
- CZ Kulatý štětec
RO Pensula rotundă
H Marokkeset
E Brocha redonda



No.	brush width / szerokość pędzla W (mm)	bristle length / długość włosia (mm)	
09581	20	44/39	50
09583	30	51/46	50
09585	40	51/46	50
09587	50	57/52	50
09589	60	57/52	50

- PL Ławkowiec
GB Paint brush
D Malerbürste
RUS Кисть-макловица деревянная ручка
- CZ Natírací kartáč profesionální
RO Bidinea profesională
H Profesionális kenőkefe
E Brocha prof.



No.	brush width / szerokość pędzla W (mm)	bristle length / długość włosia (mm)	
09647	170x65	64/58	10
09648	180x75	70/64	10
09649	190x85	76/68	10

- PL Pędzle malarskie
GB Paint brushes
D Pinselset
RUS Набор кистей
- CZ Sada maličských štětců
RO Set pensule
H Festőecset készlet
E Brochas de pintar



No.	W (mm)	pcs	
09920	25; 36; 50	3	25/200
09930	36; 50; 63	3	40/160
09950	13; 25; 36; 50; 63	5	25/100

- PL Smolowiec
GB Brush for pitch
D Pechstein
RUS Кисть для смолы
- CZ Kartáč asfaltěrský
RO Perie pt. asfalt
H Kátránykenő kefe
E Brocha para alquitrán



No.	mm	
09653	195	30

- PL Pędzel do tapet
GB Brush for wallpapers
D Flächenstreicher
RUS Кисть-макловица деревянная ручка
- CZ Štětec na tapety dřevěný
RO Bidinea profi pt. tapet
H Ecset fa tapétákhoz
E Brocha de empapelar madero



No.	brush width / szerokość pędzla W (mm)	bristle length / długość włosia (mm)	
09636	110x30	51/46	30
09638	130x30	51/46	30
09640	140x40	57/52	30
09642	150x50	64/59	30

- PL Chłapacz PCV
GB Paint brush
D Deckenbürste
RUS Кисть-макловица ПВХ
- CZ Smeták PVC
RO Bidinea PVC
H PVC meszelő
E Brocha de PVC

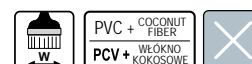

No.	brush width / szerokość pędzla W (mm)	
09651	170x60	30

- PL Ławkowiec PET
GB Paint brush
D Malerbürste
RUS Кисть-макловица PET
- CZ Natírací kartáč
RO Bidinea
H Kenőkefe
E Brocha



No.	brush width / szerokość pędzla W (mm)	
09655	150x70	12
09650	170x70	12
09656	180x80	10

- PL Wielofunkcyjna podstawa gospodarcza
GB All purpose boot tray
D Garten- & Haushalt-Unterlage
RUS Многофункциональный поднос
- CZ Multifunkční podložka
RO Tava multifunctionala
H Többfunkciós tálcá
E Bandeja de arranque universal

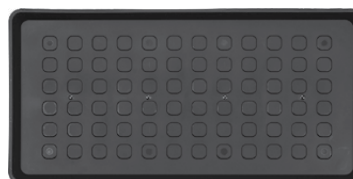

No.	mm	
67260	780x384x32	30

PL Folia ochronna malarska
GB Sheet for construction works
D Abdeckplane
RUS Пленка защитная

CZ Stavební fólie
RO Folie pt. constructii
H Építési fólia
E Lona protectora

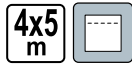

No.	m	µm	material / material	☐
09462	4x5	5	HDPE	40
09463	4x5	15	LDPE	20

PL Worki na gruz, mocne
GB Debris bags
D Müllsäcke stabil
RUS Мешки для строительного мусора

CZ Pytle na suť
RO Saci pt. demolari
H Sittes zsák
E Bolsas para escombros



No.	l	pcs packing	µm	☐
09475	80	10	142	10
09476	80	3	142	10
09477	120	10	142	10
09478	120	3	142	10

PL Worki na styropian
GB Waste bags for styrofoam
D Styropor Entsorgungssäcke
RUS Пакеты для мусора строительные материалы

CZ Pytle na polystyren
RO Saci gunoi
H Szemeteszsák
E Sacos de poliestireno

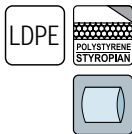

No.	l	pcs packing	µm	☐
09472	240	10	40	10

PL Taśma maskująca, niebieska
GB Blue masking tape
D Malerei blau Tape
RUS Малярна стрічка

CZ Maskovací páska
RO Bandă de mascare
H Fedőszalag
E Cinta de enmascarar



No.	W (mm)	L (m)	☐
75120	30	25	40
75121	38	25	24
75122	48	25	24
75123	30	50	40
75124	38	50	24
75125	48	50	24

PL Folia budowlana mocna
GB Sheet for construction works
D Abdeckplane
RUS Пленка защитная строительная повышенной прочности

CZ Stavební fólie
RO Folie pt. constructii
H Építési fólia
E Lona protectora



No.	m	µm	☐
09457	4x5	20	15
09459	4x5	30	10

PL Worki na odpady, budowlane
GB Construction waste bags
D Müllsäcke
RUS Мешки для строительного мусора

CZ Pytle na stavební odpad
RO Saci gunoi pt. santier
H Zsák építési törmelékhez
E Bolsas para desperdicios de construcción



No.	l	pcs packing	µm	☐
09470	80	10	40	30
09471	120	15	60	10

PL Taśma papierowa samoprzylepna
GB Self adhesive paper tape
D Papierband selbstklebend
RUS Лента малярная бумажная
CZ Páska papírová samolepící
RO Banda adeziva hartie
H Öntapadó papírszalag
E Cinta de papel adhesiva



No.	W (mm)	L (m)	☐
75270	19	25	12/48
75271	25	25	36
75272	30	25	10/40
75273	38	25	6/24
75274	48	25	6/24
75285	25	50	9/36
75286	30	50	10/40
75287	38	50	6/24
75288	48	50	6/24



PL Taśma tynkarska elewacyjna
 GB Plastering tape
 D Putzband
 RUS Штукатурные лента

CZ Fasádní omítková páska
 RO Banda mascare pt. tencuieli
 H Homlokzati festő szalag
 E Cinta de escayola



No.	W (mm)	L (m)	
75130	38	20	24
75131	48	20	24
75132	38	50	28
75133	48	50	24

PL Taśma dwustronna do wykładzin
 GB Double-sided carpet tape
 D Doppelseitiges Klebeband für Auslegware
 RUS Двухсторонняя клейкая лента для укладки ковровых покрытий
 CZ Obojstranná lepicí páska (na podlahové krytiny)
 RO Bandă cu două părți adezive pt. mochete
 H Kétoldalas szalag szőnyegpadlókhöz
 E Cinta doble cara para alfombras



No.	W (mm)	L (m)	
75260	50	5	48
75261	50	10	36
75262	50	25	24

PL Taśma dwustronna na folii
 GB Double-sided tape
 D Doppelseitiges Band auf PP-Folie
 RUS Клейкая лента двухсторонняя на полипропиленовой основе
 CZ Obojstranná páska na PP folii
 RO Bandă cu două fețe pt. folii
 H Kétoldalas
 E Cinta doble cara sobre la base de PP



No.	W (mm)	L (m)	
75245	50	5	72
75246	50	10	72
75247	50	25	36

PL Taśma aluminiowa
 GB Aluminium tape
 D Aluminiumband
 RUS Алюминиевая клейкая лента

CZ Hliníková páska
 RO Bandă aluminiu
 H Alumínium szalag
 E Cinta de aluminio



No.	W (mm)	L (m)	
75140	48	10	36
75141	48	50	24

PL Taśma tekstylna „DUCT”
 GB „DUCT” tape
 D Textilband „DUCT”
 RUS Лента армированная на тканевой основе

CZ Textilní páska „DUCT”
 RO Bandă textilă „DUCT”
 H „DUCT” textil szalag
 E Cinta textil „DUCT”



No.	W (mm)	L (m)	
75238	48	10	24
75239	38	50	28
75240	48	50	24

PL Taśma samoprzylepna dwustronna
 GB Mounting tape
 D Doppelseitiges montageband
 RUS Двухсторонняя монтажная лента

CZ Páska montážní dvoustřvrstvá
 RO Scotch cu banda dubla
 H Kétoldalas ragasztószalag
 E Cinta adhesiva, ambos lados

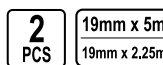

No.	W (mm)	L (m)	
75100	19	2.25; 5	12/96

- PL Taśma pakowa brązowa
GB Packing tape, brown
D Verpackungsband aus PP, braun
RUS Упаковочная клейкая лента
- CZ Balíci páska PP hnědá
RO Bandă ambalare PP maro
H PP barna ragasztószalag
E Cinta de embalaje PP marrón



No.	W (mm)	L (m)	
75301	48	40	36
75302	48	66	36

- PL Taśma pakowa
GB Packing tape
D Band
RUS Упаковочная клейкая лента
- CZ Balíci páska
RO Banda scotch
H Csomagolószalag
E Cinta de embalaje



No.	W (mm)	L (m)	
75300	48	45	12/36

- PL Wiadro budowlane
GB Plastic bucket
D Baueimer
RUS Ведро строительное
CZ Stavební vědro
RO Găleată pt. construcții
H Kőműves vödör
E Cubo de obra



No.	l	
06388	10	900
06390	12	680
06393	16	450
06392	20	390

- PL Wiadro malarskie
GB Painting bucket
D Malereimer
RUS Ведро малярное пласмассовое
- CZ Vědro maliřské
RO Găleată zidar
H Festvödör
E Cubo para pintar



No.	l	mm	
09400	14	360x250x225	315

- PL Taśma pakowa przezroczysta
GB Packing tape, transparent
D Verpackungsband aus PP, durchsichtig
RUS Упаковочная клейкая лента
CZ Balíci páska PP průhledná
RO Bandă ambalare PP transparentă
H Átlátszó ragasztószalag
E Cinta de embalaje PP transparente



No.	W (mm)	L (m)	
75303	48	40	36
75304	48	66	36

- PL Taśma PCV do użytku zewnętrznego
GB PVC tape
D PVC Band
RUS Лента ПВХ для внешних работ
- CZ Páska PVC
RO Bandă PVC
H Kétoldalas PVC
E Cinta PVC

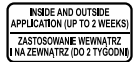

No.	W (mm)	L (m)	
75031	48	33	50

- PL Wiadro budowlane z wylewką
GB Plastic bucket
D Baueimer
RUS Ведро строительное со сливом
CZ Stavební vědro
RO Găleată pt. construcții
H Kőműves vödör
E Cubo de obra con pico



No.	l	
06391	12	720

- PL Kastrა budowlana
GB Tub for mass mixing
D Mörtelkasten
RUS Таз строительный круглый
- CZ Stavební vědro
RO Vas plastic constructii
H Kőműves vödör
E Cubo de obra



No.	l	
06397	40	110
06398	65	100
06399	90	160

PL Kastrა budowlana CZ Stavební vědro
 GB Tub for mass mixing RO Vas plastic constructii
 D Mörtelkasten H Kőműves vödör
 RUS Кювета для перемешивания раствора E Cubo de obra



No.	l	
06394	40	210
06395	60	210
06396	90	120

PL Wiadro ocynkowane
 GB Galvanized bucket
 D Baueimer
 RUS Ведро оцинкованное
 CZ Vědro
 RO Căleată
 H Kőműves vödör
 E Cubo



VOREL

No.	l	
89560	5	900
89561	7	450
89562	10	600
89563	12	500
89564	15	400

PL Uchwyt do szyb CZ Podtlakový úchyt na sklo
 GB Suction lifter RO Ventuze
 D Glas-Gummissauger H Szélvédő kiemelő
 RUS Держатель-присоска для стекол двойная E Elevadores tipo ventosa

115 Ømm 70 kg



VOREL

No.	Ø (mm)	kg	
05301	115	70	24

PL Uchwyt do szyb CZ Podtlakový úchyt na sklo
 GB Suction lifter RO Ventuze
 D Glas-Gummissauger H Szélvédő kiemelő
 RUS Держатель-присоска для стекол одинарная E Elevadores tipo ventosa

115 Ømm 40 kg
 AI



VOREL

No.	Ø (mm)	kg	
05311	115	40	50

PL Wiadro ogrodnicze CZ Zahradní vědro
 GB Garden bucket RO Căleată de grădină
 D Garten Eimer H Kerti vödör
 RUS Ведро огородное E Cubo de jardín

PE+PP



FLO

No.	l	
35600	15	500

PL Uchwyt do szyb CZ Podtlakový úchyt na sklo
 GB Suction lifter RO Ventuze
 D Glas-Gummissauger H Szélvédő kiemelő
 RUS Держатель-присоска для стекол одинарная E Elevadores tipo ventosa

115 Ømm 40 kg



VOREL

No.	Ø (mm)	kg	
05300	115	40	48

PL Uchwyt do szyb CZ Podtlakový úchyt na sklo
 GB Suction lifter RO Ventuze
 D Glas-Gummissauger H Szélvédő kiemelő
 RUS Держатель-присоска для стекол тройная E Elevadores tipo ventosa

115 Ømm 100 kg



VOREL

No.	Ø (mm)	kg	
05302	115	100	12

PL Uchwyt do szyb CZ Podtlakový úchyt na sklo
 GB Suction lifter RO Ventuze
 D Glas-Gummissauger H Szélvédő kiemelő
 RUS Держатель-присоска для стекол двойная E Elevadores tipo ventosa

115 Ømm 70 kg
 AI



VOREL

No.	Ø (mm)	kg	
05312	115	70	10

PL Hak budowlany
GB Hook
D Mauerhaken
RUS Крюк строительный

CZ Stavební hák
RO Cârlig de construcții
H Építőipari horog
E Gancho de obra



JUKO

No.	pcs
34950	25

PL Temperówka do ołówków stolarskich
GB Carpenter's pencil sharpener
D Zimmermann-Bleistift-Anspitzer
RUS Точилка для столярных карандашей

CZ Ořezávkto na tesařskou tužku
RO Ascuzitoare pt. creioane de tamplarie
H Ceruzahegyező
E Sacarpuntas para lápiz de carpintero



VOREL

No.	pcs
09190	40/240

PL Podkładki dystansowe do zbrojeń
GB Spacer pads
D Bewehrung Abstandhalter
RUS Фиксатор опоры для арматуры

CZ Distanční podložka
RO Distanțiere pt. armare
H Távtartó
E Separador corona



VOREL

No.	cleading thickness / grubość otuliny (mm)	pcs
49780	10; 20	50
49781	20; 25	50
49782	25; 30	50

PL Listwy dystansowe do zbrojeń
GB Plastic bridge spacer
D Abstandleiste
RUS Раскладка для установки арматуры

CZ Distanční lišta plastová
RO Distanțiere pt. armare tip pod
H Távtartó
E Separadores lineales



VOREL

No.	L (m)	cleading thickness / grubość otuliny (mm)	pcs
49790	1	20	10
49791	1	25	10
49792	1	30	10

PL Ołówek stolarski
GB Carpenter's pencil
D Zimmermannsbleistifte
RUS Карандаш столярный

CZ Tesařská tužka
RO Creion de tâmplărie
H Asztafos ceruza
E Lapiz de carpintero

180 mm



No.	L (mm)	pcs
09180	180	12

PL Klucz do wiązania drutu zbrojeniowego
GB Wire tying twister hook
D Rödeldraht-Drillkurbel
RUS Крючок для вязки арматуры

CZ Radlovačka
RO Dispozitiv pt. legat fier beton
H Huzalsodró
E Gancho para amarrar alambre

240 mm



VOREL

No.	L (mm)	pcs
49830	240	20

PL Podkładki dystansowe do zbrojeń
GB Spacer pads
D Bewehrung Abstandhalter
RUS Фиксатор опоры для арматуры

CZ Distanční podložka
RO Distanțiere pt. armare
H Távtartó
E Separador corona



VOREL

No.	cleading thickness / grubość otuliny (mm)	pcs
49785	15; 20	50
49786	20; 25	50
49787	25; 30	50

PL Klucz do gięcia prętów
GB Hand bar bender
D Metallbieger
RUS Рычажный трубогиб

CZ Ruční ohybačka
RO Dispozitiv de indoit
H Kézi betonacél hajlító
E Curvador de tubos

930 mm

6-14 mm

6-16 mm



VOREL

No.	L (mm)	pcs
49810	930	4

- PL Giętarka łożyskowa do drutu
GB Bearing bender for bar
D Drahtbiegevorrichtung, mit Lager
RUS Ручной станок для гибки арматуры
- CZ Ohýbačka drátu s ložiskem
RO Dispozitiv pt. îndoit suport sârmă
H Csapágyas dróthajlító
E Dobladora de alambre con rodamiento



No.	Ø (mm)	mm	bearing / ložisko (mm)	
49805	6-8	17x17x5	35x15	2
49806	10-14	25x20x5	45x20	2

- PL Chwytek brukarski wzdużny regulowany
GB Longitudinal clamp
D Bordstein-Verlegezange
RUS Захват-клевщи для бордюра продольные
- CZ Kleště na obrubníky podélné
RO Cleste pt. borduri
H Hosszírányúszegélykő emelő fogó
E Pinza de colocación de rebordes mecánica



No.	grip range / zakres chwytu (mm)	
35010	980-1170	2

- PL Zapasowe końcówki do chwytaka
GB Rubber for lateral clamp
D Ersatzgummi für Bordsteinverlegezange
RUS Запасные наконечники
- CZ Náhradní gumový úchyt
RO Mânere de cauciuc de rezervă
H Gumi alkatrészek
E Punta de repuesto



No.	for / dla	pcs	
35013	35012	4	10

- PL Chwytek brukarski jednoręczny regulowany
GB Slabgrabber
D Pflasterstein- und Klinker-Träger
RUS Захваты для тротуарной плитки
кирпича, блоков
- CZ Kleště na dlažbu a cihly
RO Cleste pt. caramizi
H Burkolólap fogó
E Pinza de colocación de losas



No.	grip range / zakres chwytu (mm)	
35017	255-400	4

- PL Giętarka do drutu zbrojeniowego
GB Bender for reinforcement bar
D Biegevorrichtung für Bewehrungsdraht
RUS Ручной станок для гибки арматуры
- CZ Ohýbačka armovacího drátu
RO Dispozitiv pt. îndoit sârmă de armare
H Betonvas hajlító
E Dobladora de alambre de reforzamiento



No.	Ø (mm)	mm	
49800	6-8	16x12x5	4
49801	10-12	25x16x6	4
49802	14-16	25x16x6	2

- PL Chwytek poprzeczny, podwójny
GB Lateral clamp
D Bordsteinverlegezange
RUS Захват-клевщи для бордюра поперечные
- CZ Kleště na obrubníky příčné
RO Cleste pt. borduri
H Keresztrányúszegélykő emelő fogó
E Pavimentación pinza doble



No.	grip range / zakres chwytu (mm)	
35012	200-510	2

- PL Chwytek zbiorczy do kostki brukowej
GB Grapple for cobblestones
D Pflastersteinträger
RUS Захват ручной для переноса
бордюрного камня и блоков
- CZ Nosič na cihly
RO Cleste pt. borduri
H Emelő fogó
E Pinza para bordillos longitudinal

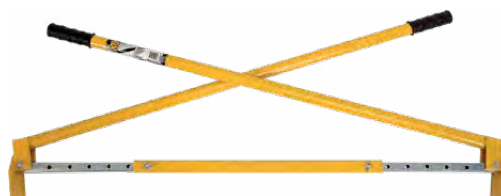

No.	grip range / zakres chwytu (mm)	
35015	700-1100	4

- PL Imak brukarski regulowany
GB Paver puller
D Steinzieher-Steinheber
RUS Захват для камня
- CZ Kleště na vytahování dlažby
RO Ridicator de pavele
H Térkökiemelő szerszám
E Extractor de adoquines



No.	grip range / zakres chwytu (mm)	
35020	80-275	4

- PL Zapasowe ostrza do imaka
GB Blades for paver puller
D Ersatzklingen für Steinzieher-Steinheber
RUS Зарпасные лезвия
- CZ Náhradní čepel
RO Tartalék penge
H Lame de rezerva
E Cuchillas de repuesto



No.	for / dla	pcs	
35021	35020	2	20

- PL Ostrze do łomu brukarskiego
GB Blade for paver adjuster
D Ersatzklingen für Richtleisten
RUS Зарпасные лезвия
- CZ Náhradní čepel
RO Lame de rezerva
H Tartalék penge
E Cuchillas de repuesto



No.	for / dla	
35026	35025	20

- PL Zgarniacz brukarski do podsypki
GB Paver lifter
D Plan-Abzieher für Pflasterbau
RUS Правило для выравнивания основания под тротуарную плитку
- CZ Stahovací lišta
RO Sistem de nivelare manuala
H Ágyazat lehúzó rendszer
E Sistema de enrasado manual

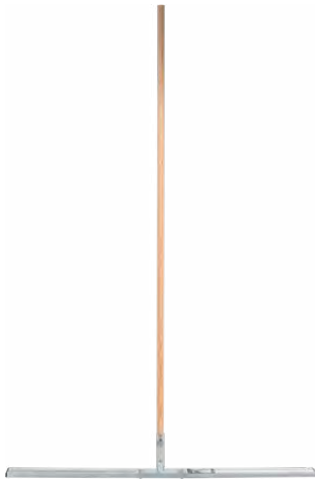

No.	L (cm)	
35033	75	1
35032	120	1

- PL Łom wyważak brukarski
GB Paver adjuster
D Richtleisen für Pflasterbau
RUS Лом с упором для демонтажа тротуарной плитки
- CZ Tyč pro opravu dlažby
RO Bara de aliniere pavaj
H Tértő sorrendező
E Barra alineadora de adoquines



No.	
35025	4



- PL Zgarniacz brukarski do podsypki
GB Paver lifter
D Plan-Abzieher für Pflasterbau
RUS Правило для выравнивания основания под тротуарную плитку
- CZ Stahovací lišta
RO Sistem de nivelare manuala
H Ágyazat lehúzó rendszer
E Sistema de enrasado manual

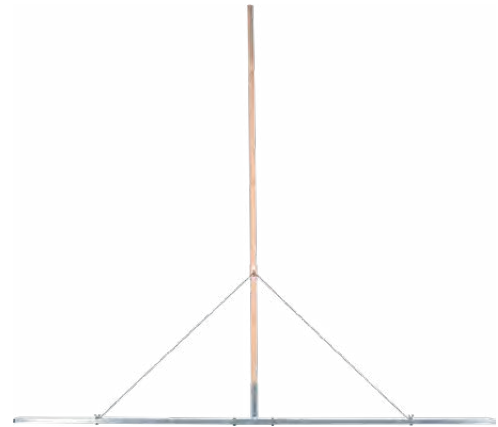

No.	L (cm)	
35031	150	1
35030	200	1

															Memo
--	--	--	--	--	--	--	--	--	--	--	--	--	--	--	------

12

Measuring tools Narzędzia miernicze



Digital universal meters
Cyfrowe mierniki uniwersalne

.....182-183

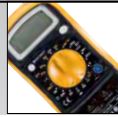

Measuring tapes
Miary zwijane

.....183-184



Wooden folding rules
Miary składane drewniane

.....184



Plastic folding rules
Miary składane z tworzywa

.....184



Feeler gauges
Szczelinomierze

.....184



Vernier calipers
Suwmiarki

.....185



Chalk lines
Sznury traserskie

.....185-186



Ropes & lines
Sznury i linki

.....186-188



Plumb bobs
Piony murarskie

.....188



Try squares
Kątowniki stolarskie

.....188-189



Rulers
Przymiary

.....190



Electronic measuring tools
Elektroniczne urządzenia pomiarowe

.....190-191



Levels
Poziomnice

.....191-193



Scales
Wagi

.....193



Magnifiers
Lupy

.....193



PL Cyfrowy miernik uniwersalny
 GB Digital universal multimeter
 D Universal digital Multimeter
 RUS Универсальный цифровой мультиметр
 CZ Digitální multimetr - univerzální
 RO Multimetru digital universal
 H Digitális multiméter
 E Manómetro digital universal



U D.C. 0-500V	U A.C. 0-500V
I D.C. 0-5A	R 0-2MΩ
h _{FE} PNP NPN	



No.	digit height / wysokość cyfr (mm)	
81780	12/72	1

PL Cyfrowy miernik uniwersalny
 GB Digital universal multimeter
 D Universal digital Multimeter
 RUS Универсальный цифровой мультиметр
 CZ Digitální multimetr - univerzální
 RO Multimetru digital universal
 H Digitális multiméter
 E Manómetro digital universal



U D.C. 0-600V	U A.C. 0-600V	I A.C. 0-10A
I D.C. 0-10A	R 0-200 MΩ	f 20kHz max
C 0-20μF	T -40° ÷ +400°C	h _{FE} PNP NPN
		AUTO POWER OFF WYŁĄCZANIE AUTOMATYCZNE



No.	digit height / wysokość cyfr (mm)	
81784	25	20

PL Cyfrowy miernik uniwersalny
 GB Digital universal multimeter
 D Universal digital Multimeter
 RUS Универсальный цифровой мультиметр
 CZ Digitální multimetr - univerzální
 RO Multimetru digital universal
 H Digitális multiméter
 E Manómetro digital universal



U D.C. 0-500V	U A.C. 0-500V	I D.C. 0-10A
R 0-20 MΩ	1.5/9/12V BATTERY TEST TEST BATERII	
	DATA HOLD	LED BACKLIGHT POŚWIETLENIE
LCD 1999	9V (6F22)	



No.	digit height / wysokość cyfr (mm)	
81774	50	1

PL Cyfrowy miernik uniwersalny
 GB Digital universal multimeter
 D Universal digital Multimeter
 RUS Универсальный цифровой мультиметр
 CZ Digitální multimetr - univerzální
 RO Multimetru digital universal
 H Digitális multiméter
 E Manómetro digital universal

U D.C. 0-600V	U A.C. 0-600V	I A.C. 0-10A
I D.C. 0-10A	R 0-200 MΩ	f 20kHz max
C 0-20μF	h _{FE} PNP NPN	
	AUTO POWER OFF WYŁĄCZANIE AUTOMATYCZNE	



No.	digit height / wysokość cyfr (mm)	
81783	25	20

PL Cyfrowy miernik uniwersalny
 GB Digital universal multimeter
 D Universal digital Multimeter
 RUS Универсальный цифровой мультиметр
 CZ Digitální multimetr - univerzální
 RO Multimetru digital universal
 H Digitális multiméter
 E Manómetro digital universal



U D.C. 0-600V	U A.C. 0-600V
I D.C. 0-10A	R 0-2 MΩ
h _{FE} PNP NPN	
	DATA HOLD
LED BACKLIGHT POŚWIETLENIE	9V (6F22)



No.	digit height / wysokość cyfr (mm)	
81773	50	1

PL Cyfrowy miernik uniwersalny
GB Digital universal multimeter
D Universal digital Multimeter
RUS Универсальный цифровой мультиметр

CZ Digitální multimetr - univerzální
RO Multimetru digital universal
H Digitális multiméter
E Manómetor digital universal

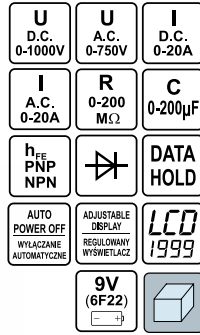

No.	Icon
81775	40

PL Miara zwijana
GB Measuring tape
D Rollbandmass
RUS Рулетка
CZ Měřicí pásmo
RO Rulete din
H Mérőszalag
E Flexometro



No.	L (m)	W (mm)	Icon
10101	2	16	12/120
10104	3	16	12/120
10106	5	16	12/120
10109	7.5	19	6/60
10111	10	25	6/60

PL Miara zwijana
GB Measuring tape
D Rollbandmass
RUS Рулетка

CZ Měřicí pásmo
RO Rulete din
H Mérőszalag
E Flexometro



No.	L (m)	W (mm)	Icon
10130	2	16	12/120
10133	3	16	12/120
10135	5	16	12/120
10138	8	25	6/60
10139	10	25	6/60

PL Cęgowy miernik uniwersalny
GB Clamp universal multimeter
D Universell Klemme Messgerät
RUS Универсальный цифровой измеритель

CZ Digitální multimetr - univerzální
RO Multimetru digital universal
H Digitális multiméter
E Manómetor digital universal

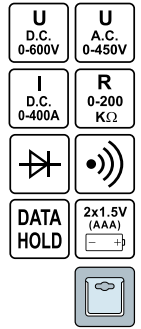

No.	Icon
81801	5/60

PL Miara zwijana
GB Measuring tape
D Rollbandmass
RUS Рулетка
CZ Měřicí pásmo
RO Rulete din
H Mérőszalag
E Flexometro



No.	L (m)	W (mm)	Icon
10122	2	16	12/120
10123	3	16	12/120
10125	5	19	12/120
10128	7.5	25	6/60
10129	10	25	6/60

PL Miara zwijana
GB Measuring tape
D Rollbandmass
RUS Рулетка

CZ Měřicí pásmo
RO Rulete din
H Mérőszalag
E Flexometro



No.	L (m)	W (mm)	Icon
11310	3	16	12/120
11311	5	19	12/120
11313	8	25	6/60

PL Taśma miernicza stalowa
GB Steel measuring tape
D Rollbandmass
RUS Мерная лента стальная

CZ Měřicí pásmo ocelové
RO Ruleta din oțel
H Acél mérőszalag
E Cinta de medir de acero



No.	L (m)	W (mm)	
12100	10	10	25/50
12200	20	10	25/50
12300	30	10	10/30
12500	50	10	10/30

PL Taśma miernicza z włókna szklanego
GB Fibreglass measuring tape
D Rollbandmass
RUS Мерная лента фиберглассовая

CZ Měřicí pásmo /skleněné vlákno/
RO Ruleta fibra sticla
H Mérőszalag /üvegszál/
E Cinta de medir /fibra cristal/



No.	L (m)	packing	
14100	10		20/100
14200	20		12/60
14300	30		12/60
14500	50		10/30

PL Miara drewniana, składana, okuta
GB Wooden folding rule
D Gliedermassstab
RUS Метр складной деревянный

CZ Měřicí pásmo dřevěné skladané /okované/
RO Metru tamplar lemn
H Fa colstok /vasalt/
E Metro de madera, plegable /articulado/



VOREL

No.	type	L (m)	
15004	PERFECT B-Ž	1	20/200
15006	PERFECT B-Ž	2	10/100

PL Miara plastikowa
GB Plastic folding rule
D Kunststoffgliedermassstab
RUS Метр складной пластмассовый

CZ Měřicí pásmo plastové skladané
RO Metru de plastic
H Műanyag, összehajtható mérce
E Metro de plástico, plegable

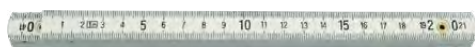

No.	L (m)	
15050	1	20/200
15070	2	12/120

PL Taśma miernicza stalowa, geodezyjna
GB Steel measuring tape
D Rollbandmass
RUS Мерная лента стальная геодезическая

CZ Měřicí pásmo ocelové
RO Ruleta cu picior
H Acél mérőszalag
E Cinta de mednir de acero geodezico



No.	L (m)	
13200	20	10/20
13300	30	10/20
13500	50	10/20

PL Miara drewniana, składana, okuta
GB Wooden folding rule
D Gliedermassstab
RUS Метр складной деревянный

CZ Měřicí pásmo dřevěné skladané /okované/
RO Metru tamplar lemn
H Fa colstok /vasalt/
E Metro de madera, plegable /articulado/



No.	L (m)	
15010	1	24/480
15020	2	12/240

PL Miara drewniana, składana, okuta
GB Wooden folding rule
D Gliedermassstab
RUS Метр складной деревянный

CZ Měřicí pásmo dřevěné skladané /okované/
RO Metru tamplar lemn
H Fa colstok /vasalt/
E Metro de madera, plegable /articulado/



VOREL

No.	type	L (m)	
15005	PERFECT B	1	20/200
15007	PERFECT B	2	10/100

PL Szczelinomierz
GB Feeler
D Fühlerlehre
RUS Щупы автомобильные

CZ Spároměr
RO Lere
H Hézagmértő
E Calibre de fisuras



VOREL

No.	mm	pcs	
15130	0.05-1.00	13	15/300
15200	0.05-1.00	20	10/200

PL Suwmiarka plastikowa CZ Plastové posuvné měřítko
 GB Plastic caliper RO Subler masurat sprancene
 D Kunststoff-Bremssattel H Müanyag tolmérő
 RUS Штангенциркуль пластиковый E Calibre vernier regla – plástico

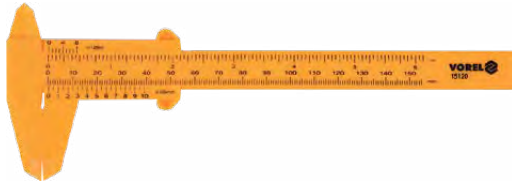
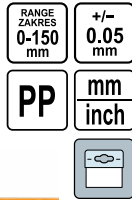

No.	L (mm)	mm	
15120	150	0.05	50/500

PL Suwmiarka CZ Posuvné měřítko
 GB Vernier caliper RO Şubler
 D Messschieber H Tolómérő
 RUS Штангенциркуль E Calibre



No.	L (mm)	mm	packing	
15100	150	0.05		40
15110	150	0.02		10/100

PL Suwmiarka elektroniczna CZ Posuvné měřítko elektronické
 GB Digital caliper RO Şubler electronic
 D Digital Messschieber H Elektronikus tolmérő
 RUS Штангенциркуль электронный E Calibre electronic

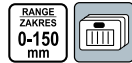

No.	L (mm)	mm	
15240	150	0.03	10/50

PL Sznur traserski CZ Orysováci šňúra
 GB Chalk line RO Şnur de trasat
 D Schnurlot H Kicsapózsínor
 RUS Шнур-отвес малярный E Cordel tizador



No.	L (m)		
17501	15		10/100

PL Suwmiarka CZ Posuvné měřítko
 GB Vernier caliper RO Şubler
 D Messschieber H Tolómérő
 RUS Штангенциркуль E Calibre



No.	L (mm)	mm	
15115	150	0.02	10/100

PL Suwmiarka zegarowa CZ Posuvné měřítko hodinové
 GB Dial caliper RO Subler cu cadran
 D Präzisions-Uhrmessschieber H Órás tolmérő
 RUS Штангенциркуль стрелочный E Calibre dial

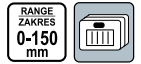

No.	L (mm)	mm	
15220	150	0.02	10/50

PL Sznur traserski CZ Orysováci šňúra
 GB Chalk line RO Şnur de trasat
 D Schnurlot H Kicsapózsínor
 RUS Шнур-отвес малярный E Cordel tizador



No.	L (m)		
17500	15		10/100

PL Sznur traserski z kredą niebieską CZ Orysováci šňúra
 GB Chalk line & blue chalk RO Fir trasare si praf de creta albastra
 D Schlagschnur mit Kreide H Kicsapózsínor
 RUS Шнур-отвес малярный + краска E Cordel tizador con tiza azul





No.	L (m)	g	
17505	15	115	10/60

PL Kreda traserska
GB Blue / red chalk
D Kreide blau / rot
RUS Краска для шнура

CZ Křída trasovací
RO Praf de creta pt. trasat
H Jelölő krétapor
E Tiza azul/rojo

115g 



No.	g	colour / kolor	
17507	115		20/80
17508	115		20/80

PL Sznurek murarski
GB Builders line
D Maurerschnur
RUS Шнур каменщика

CZ Šňůra zednická
RO Sfoară pt. zidari
H Kőműves zsinór
E Cuerda de albañil

75 m 

EASY ROLL-ON
LATIVE ROZWIĄZANIE

PE LINE
LINKA PE

PUSHING INTO SOFT EARTH
MOŻLIWOŚĆ WBIĘCIA W MIĘKKĄ ZIEMIĘ





12

No.	L (m)	
17495	75	12/48

PL Sznurek murarski
GB Builders line
D Maurerschnur
RUS Шнур каменщика

CZ Šňůra zednická
RO Sfoară pt. zidari
H Kőműves zsinór
E Cuerda de albañil



No.	L (m)	colour / kolor	
17488	50		60
17489	100		60

PL Sznurek murarski polietylenowy
GB Polyethylene bricklayer's string
D Geflochtenes Seil aus Polyäthylen
RUS Полиэтиленовый шнур каменщика

CZ Šňůra zednická polyetylenová
RO Șnur de zidărie din polietilena
H Kőműves zsinór, polietilén
E Cordel de albañilería de polietileno



No.	Ø (mm)	L (m)	
17480	1.7	50	60/240
17481	1.7	100	30/120
17483	2.0	50	60/240
17484	2.0	100	30/120

PL Sznurek murarski
GB Builders line
D Maurerschnur
RUS Шнур - причалка

CZ Šňůra zednická
RO Sfoară pt. zidari
H Kőműves zsinór
E Cuerda de albañil

40 m 



No.	L (m)	
17490	40	80

PL Sznurek murarski
GB Builders line
D Maurerschnur
RUS Шнур каменщика

CZ Šňůra zednická
RO Sfoară pt. zidari
H Kőműves zsinór
E Cuerda de albañil



No.	Ø (m)	L (m)	
17497	1.2	75	12/48
17498	1.2	200	12/48

PL Sznurek murarski, polipropylenowy
GB Polypropylene bricklayer's string
D Geflochtenes Seil aus Polypropylen
RUS Шнур каменщика

CZ Šňůra zednická polypropylenová
RO Șnur de zidărie din polietilena
H Kőműves zsinór, polipropilén
E Cordel de albañilería



No.	Ø (mm)	L (m)	
17470	1.7	50	60/240
17471	1.7	100	30/120
17473	2.0	50	60/240
17474	2.0	100	30/120

PL Linka pleciona polipropylenowa
GB Polypropylene sennit line
D Geflochtenes Seil aus Polypropylen
RUS Канат полипропилен

CZ Lano pletené polypropylenové
RO Coarda împletită din polipropilena
H Polipropilén fonott kátél
E Cuerda trenzada de polipropileno



No.	Ø (mm)	L (m)	
69521	4	20	50

- PL Linka pleciona polipropylenowa
 GB Polypropylene sennit line
 D Geflochtenes Seil aus Polypropylen
 RUS Канат полипропиленовый плетеный
- CZ Lano pletené polypropylenové
 RO Coarda impletita din polipropilena
 H Polipropilén fonott kötél
 E Cuerda trenzada de polipropileno



No.	Ø (mm)	L (m)	
69502	4	400	4
69503	5	250	4
69504	6	250	4
69505	8	300	2
69506	10	200	2
69507	12	180	1
69508	14	110	1
69509	16	80	1
69510	18	70	1

- PL Sznurek PP pleciony, uniwersalny
 GB Universal PP sennit string
 D PP-Schnur, geflochten, universell
 RUS Шнур полипропиленовый
- CZ Šňůra PP pletená univerzální
 RO Șnur PP împletit, universal
 H PP fonott kötél, univerzális
 E Cordel trenzado universal PP



No.	Ø (mm)	L (m)	
69620	3	10	50
69621	3	20	40

- PL Sznurek pakowy, jutowy
 GB Packing jute string
 D Packschnur, aus Jute
 RUS Шнур джутовый
- CZ Šňůra ucpávková jutová
 RO Șnur de împachetat, de iuta
 H Csomagköltöző spárga, juta
 E Cordel de yute para embalaje



No.	dkg	
69630	5	112
69631	10	100

- PL Uchwyty kątowe do linki murarskiej
 GB Line blocks with brick lines
 D Maurerschnur Spannklotze mit Richtschnur
 RUS Строительные уголки для причального шнура
 CZ Stavební rožky pro zednické provázky
 RO Dispozitiv pt. aliniere caramizi
 H Építési rudak falazott hűrokhoz
 E Pareja de angulares para cuerda de albañil acha

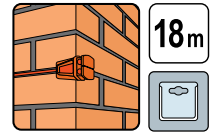

No.	L (m)	
17430	18	48/96

- PL Lina jutowa skręcana
 GB String jute rope
 D Verdrillt Seil aus Jute
 RUS Канат джутовый
- CZ Lano jutová kroucená
 RO Cablu răsucit de iuta
 H Juta sodrott kötél
 E Cable de yute torcido



No.	Ø (mm)	L (m)	
69572	10	10	40

- PL Nici lniane, dratwa
 GB Flax thread, twine
 D Leinenfaden, Pechfaden
 RUS Нить (дратва) льняная
- CZ Nítě lněné, drátev
 RO Fire de in, fire
 H Len céma, fonál
 E Hilo de lino, cabo de zapatero



No.	dkg	
69635	10	28
69637	25	18

- PL Lina igłowa
 GB Needle rope
 D Nadelseil
 RUS Канат полипропиленовый, плетеный
- CZ Lano s jádrem opletené
 RO Cablu ac
 H Tűfonatos kötél
 E Cable acalabrotado



No.	Ø (mm)	L (m)	
69539	8	10	30
69540	8	20	20
69542	10	10	25
69543	10	20	15
69546	12	20	10

- PL Sznurek PP do podwiązania wełny izolacyjnej
 GB Spliced wire polypropylene string
 D Polypropylen Ertlegar
 RUS Шнур полипропиленовый
 CZ Provázek polypropylenový
 RO Snur din polipropilena
 H Spagát polypropylénový
 E Cuerda



No.	Ø (mm)	L (m)	
69608	2.5	200	100
69609	2.5	300	80
69610	2.5	450	50
69612	2.5	1000	24
69613	2.5	2000	12

- PL Pion murarski
 GB Plumb bob
 D Senklot
 RUS Отвес со шнуром
- CZ Murařská centrace
 RO Fir cu plumb
 H Kőműves függődn
 E Plomada albañil



No.	size / rozmiar (mm)	
17300	15x70	200

- PL Kałownik stolarski
 GB Try square
 D Zimmermannswinkel
 RUS Угольник столярный
- CZ Truhlářský úhelník
 RO Echer (unghi drept) de tâmplărie
 H Asztalos derékszög
 E Escuadra de metal



No.	mm	
18250	250	12/120
18300	300	12/120
18350	350	12/120

- PL Kałownik aluminiowy
 GB Aluminium try square
 D Alu-Zimmermannswinkel
 RUS Угольник столярный алюминиевый
- CZ Truhlářský úhelník
 RO Echer (unghi drept) de tâmplărie
 H Asztalos derékszög
 E Escuadra



No.	mm	
18360	250	10/60
18361	300	10/60
18362	350	10/60

- PL Linka pleciona, elastyczna
 GB Elastic sennit line
 D Geflochtenes Seil, elastisch
 RUS Канат плетёный эластичный

- CZ Lano pletené elastické
 RO Coarda împletită, elastică
 H Fonott kötél, rugalmas
 E Cuerda trenzada elástica



No.	Ø (mm)	L (m)	
69550	6	150	1
69551	8	100	1
69552	10	100	1

- PL Pion murarski z mocowaniem magnetycznym
 GB Magnetic plumb
 D Senklot mit Haltemagnet
 RUS Магнитный строительный отвес
 CZ Olovnice se magnetu
 RO Fir cu plumb magnetic
 H Függn
 E Fios de prumo com iman

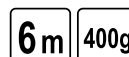

No.	m	
17310	6	6/36

- PL Kałownik stolarski
 GB Try square
 D Zimmermannswinkel
 RUS Угольник столярный
- CZ Truhlářský úhelník
 RO Echer (unghi drept) de tâmplărie
 H Asztalos derékszög
 E Escuadra de metal

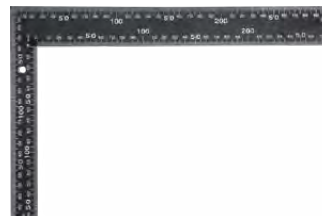

No.	mm	
18201	200x300	24/48
18200	400x600	12/24

- PL Kałownik z podpórką
 GB Angle bar with a support
 D Winkel mit Stütze
 RUS Угольник столярный с откидным упором
- CZ Úhelník s dorazem
 RO Cornier cu stand
 H Támaszos derékszögelő
 E Escuadra con soporte



No.	mm	
18501	350	30
18502	500	30
18503	750	20
18504	1000	10

- PL Kątomierz nastawny CZ Nastawitelný úhloměr
 GB Bevel protractor RO Echer reglabil
 D Winkelmesser H Állítható szögmérő
 RUS Угломер регулируемый со шкалой E Calibrador de biseles



No.	mm	
18797	350	10
18798	500	10
18799	750	10

- PL Kątomierz elektroniczny z poziomnicą CZ Protractor electronic s urovni
 GB Protractor electronic with spirit level RO Protractor electronic level cu
 D Digital Winkelmesser mit Wasserwaage H Szögmérő elektronikusak szint
 RUS Транспортir электронный с уровнем E Con el nivel electrónico transportador



No.	mm	vials / libelle	
17570	400	2	20

- PL Skońnica drewniana CZ Nastawitelný úhloměr
 GB Bevel protractor RO Echer reglabil
 D Schmiege H Állítható szögmérő
 RUS Угольник регулируемый деревянный E Calibrador de biseles



No.	mm	
18800	270	80
18810	400	60

- PL Kątownik nastawny do przenoszenia wymiarów CZ Pokosnik nastavitelní
 GB Adjustable ruler RO Echer reglabil
 D Multifunktionales Messlineal H Szögmértékek
 RUS Разметочный инструмент линейка-шаблон E Medición del ángulo

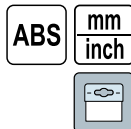

No.		
18470		20/60

- PL Kątomierz z libellą i ruchomym ramieniem CZ Protractor
 GB Protractor with level RO Muşchi extensor
 D Winkelmesser H Szogmerő
 RUS Транспортир E Transportador

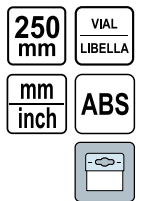

No.	mm	vials / libelle	
18473	250	1	10/60

- PL Kątomierz budowlany CZ Protractor
 GB Protractor with level RO Muşchi extensor
 D Winkelmesser H Szogmerő
 RUS Транспортир E Transportador



12



No.	mm	vials / libelle	
18790	500	2	10

- PL Kątownik ciesielski do krokwi CZ Tesafsky úhelník
 GB Triangle ruler RO Echer pt. dulgherie
 D Lineal Winkelmesser H Fém derékszög
 RUS Угольник для плотника и столяра E Escuadra

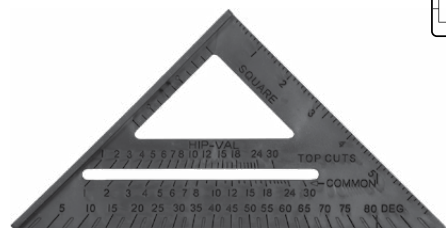
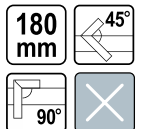

No.	mm	
18530	180	100

PL Przymiar do tapet
GB Carpenter's ruler
D Zeichen-Masstab
RUS Линейка стальная с деревянной ручкой

CZ Měřidlo stavební
RO Rigla de tamplarie
H Kőműves vonalzó
E Regla de obra



No.	mm	☐
19750	750	10/40

PL Przymiar aluminiowy, uchwyt, 2 libelki
GB Aluminium ruler, 2 vials
D Alu Zeichen-Masstab 2-lib
RUS Линейка стальная алюминиевая 2 глазка с ручкой

CZ Měřidlo hliníkové
RO Rigla de aluminiu cu 2 bule
H Alumínium vonalzó
E Regla de aluminio, mango, division 2-burbujas



12



No.	mm	vials / libelle	☐
19770	600	2	12/24

PL Dalmierz laserowy
GB Laser distance meter
D Laserentfernungsmesser
RUS Лазерный дальномер
CZ Laserový měřič vzdálenosti
RO Telemetru cu laser
H Lézeres távolságmérő
E Medidores láser de distancias

0.05-40m
+/- 2mm

20 MEMORY PAMIEĆ

8 MODES TRYBÓW

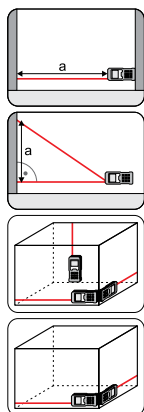

No.	☐
81790	20

PL Przymiar aluminiowy, uchwyt, 2 libelki
GB Aluminium ruler, 2 vials
D Alu Zeichen-Masstab 2-lib
RUS Линейка столовая алюминиевая 2 глазка с ручкой

CZ Měřidlo hliníkové
RO Rigla de aluminiu cu 2 bule
H Alumínium vonalzó
E Regla de aluminio, mango, division 2-burbujas

AI

1000mm

2 VIALS LIBELLE



No.	L (mm)	vials / libelle	☐
19755	1000	2	24

PL Dalmierz ultradźwiękowy z laserem
GB Ultrasonic distance meter with laser
D Ultraschall Entfernungsmesser mit Laserpointer
RUS Ультразвуковой измеритель расстояния
CZ Ultrazvukový měřič vzdálenosti
RO Aparat masurat distanta cu laser
H Léyeres, ultrahangos távolságmérő
E Distanciómetro de ultrasonido con láser

0.91-15m

0.5% ACCURACY DOĞRULUK

M1 M2 M3 3 x MEMORY 3 x PAMIEĆ

AREA POWERZECIŃNA

VOLUME KUBATURA

LASER

9V (6F22)



No.	↔ m	☐
81782	0.91-15	6/36

PL Laser krzyżowy samopoziomujący z uchwytem mocującym
GB Self-leveling cross line laser
D Selbstnivellierung Linienlaser
RUS Лазерный нивелир
CZ Křížový laser
RO Laserul crossline level
H Kereszt sugaras lézeres
E Nivel láser cruzado

635 Nm LASER MODE DEĞÜŞÜCÜ PALI

CLASS / KLASA II

± 2mm / 10m LASER ACCURACY DOĞRULUK LASERİ

1/4" (6.3mm) TRIPOD THREAD PIVOT GÖZÜKÜ STAKTIRU

4.5V 3x AA

-10°C-40°C ROOM TEMPERATURE TEMPERATURA PRACY

IP54

30m WORKING RANGE ZAKRES PRACY

± 3° SAMOPROJEKCIJA RELIEVING RANGE

8h WORK TIME CĂLĂRIE



No.	☐
18000	12

- PL Laser krzyżowy samopoziomujący trójliniowy z uchwytem mocującym
- GB Self-leveling cross line laser with 90° vertical line
- D Selbstnivellierung 3-Linienlaser
- RUS Лазерный нивелир
- CZ Křížový laser
- RO Laserul crossline level
- H Keresztisgaras lézeres
- E Nivel láser cruzado



635 Nm LASER MODE DŁUGOŚĆ FALI	CLASS II LASER KLASA	± 4 mm / 10 m LASER ACCURACY DOKŁADNOŚĆ LASERA
1/4" (6.3 mm) TYPICAL THREAD WYMIAR GWINTU STRĄTKO	4.5V 3x AAA	8 h WORK TIME CZAS PRACY
IP54	30 m WORKING RANGE ZAKRES PRACY	± 4° SAMOREGULACJA SELWELONOWANIE



No.	Quantity
18001	20

- PL Pirometr o zmiennej emisyjności
- GB Pyrometer with variable emissivity
- D Pirometer mit variabler Emissionsfähigkeit
- RUS Пирометр
- CZ Pyrometr s nastavitelnou emisivitou
- RO Pirometru cu emisivitate variabilă
- H Változó emissziójú pirométer
- E Pirómetro de emisividad variable



EMISSIVITY EMISYJNOŚĆ 0.10-1.00	-50+650 °C
9V (6F22)	AUTO POWER OFF WYŁĄCZENIE AUTOMATYCZNE
MAX AVG MIN DIFF	10 MEASUREMENT MEMORY PAMIĘĆ POMIARU
D : S 12 : 1	



No.	Quantity
81762	5/20

- PL Poziomnica trapezowa
- GB Trapezoidal spirit level
- D Trapezförmige Wasserwaage
- RUS Трапецидальный уровень
- CZ Vodováha trapezová
- RO Nivelă trapezoidală
- H Vizmértek trapéz
- E Trapezoides nivel

500 mm	SHOCK PROOF ODPORNA NA WSTRZĄSY	ACCURACY DOKŁADNOŚĆ 0.027° 0.5 mm/m
2 PRECISION VIALS LIBELLE	ALUMINIUM HIGH QUALITY PROFILE ALUMINIOWY PROFIL WYSOKIEJ JAKOŚCI	



No.	L (mm)	vials / libelle	Quantity
16280	500	2	50

- PL Wykrywacz metalu i przewodów
- GB Metal and voltage detector
- D Ortungsgerät für Metal und Leitungen
- RUS Детектор металла и проводки
- CZ Metalo ir átamos detektorius
- RO Detector metale / electricitate
- H Fém- és feszültség detektor
- E Detector de metalu y cables



9V (6F22)	STEEL STAL
LCD DISPLAY	WOOD DREWNO
	STEEL STAL



No.	Quantity
81785	20

- PL Tester grubości lakieru
- GB Paint thickness tester
- D Lackdickenmessgerät
- RUS Толщиномер лакокрасочного покрытия
- CZ Tester tloušťky laku
- RO Tester de buzunar grosime vopsea
- H Rétegvastagság mérő
- E Medidor de espesor de recubrimiento



ACCURACY DOKŁADNOŚĆ +2%	ALUMINIUM ALUMINIUM
RANGE ZAKRES 0-2.0 mm	STEEL STAL



No.	Quantity
81731	40/80

- PL Poziomnica torpedo
- GB Torpedo level
- D Wasserwaage torpedo
- RUS Уровень духа торпеда
- CZ Přesná vodováha torpédo
- RO Nivelă torpilă
- H Vizmértek torpédo
- E Nivel torpedo

230 mm	MAGNETIC	ACCURACY DOKŁADNOŚĆ 0.027° 0.5 mm/m
3 PRECISION VIALS LIBELLE		



No.	L (mm)	vials / libelle	Quantity
16300	230	3	100

PL Poziomnica torpedo
GB Torpedo level
D Wasserwaage torpedo
RUS Уровень духа торпедо

CZ Přesná vodováha torpédo
RO Nivelă torpilă
H Vizmértek torpédo
E Nivel torpedo

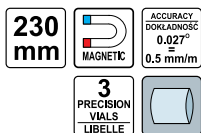

No.	L (mm)	vials / libelle	☐
16301	230	3	100

PL Poziomnica do słupków
GB Post level
D Pfostenwasserwaage
RUS Уровни на должности

CZ Hladiny do míst
RO Niveluri de către posturile
H Szintek üzenete
E Los niveles a los mensajes

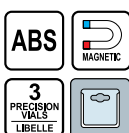

No.	vials / libelle	☐
16012	3	25/100

PL Poziomnica aluminiowa
GB Aluminium level
D Wasserwaage
RUS Уровень

CZ Vodováha
RO Cumpănă
H Vizmértek
E Nivel



No.	L (mm)	vials / libelle	☐
16551	400	3	25/50
16552	600	3	25/50
16553	800	3	25/50
16554	1000	3	25/50
16555	1200	3	15/30
16556	1500	3	15/30
16557	2000	3	10/20

PL Poziomnica laserowa mini
GB Laser level mini
D Laser Wasserwaage mini
RUS Уровни лазерные мини

CZ Úrovně laserové mini
RO Niveluri mini cu laser
H Szintek lézer mini
E Niveles lézer mini

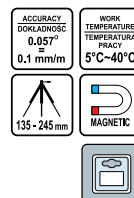

No.	☐
17560	20

PL Poziomnica aluminiowa
GB Aluminium level
D Wasserwaage
RUS Уровень

CZ Vodováha
RO Cumpănă
H Vizmértek
E Nivel



No.	L (mm)	vials / libelle	☐
16340	400	3	20/60
16360	600	3	20/60
16380	800	3	20/60
16400	1000	3	20/60

PL Poziomnica aluminiowa
GB Aluminium level
D Wasserwaage
RUS Уровень

CZ Vodováha
RO Cumpănă
H Vizmértek
E Nivel



No.	L (mm)	vials / libelle	☐
17606	600	3	20/60
17608	800	3	20/60
17610	1000	3	20/60
17612	1200	3	15/30
17615	1500	3	15/30
17620	2000	3	10/20

- PL Poziomnica wodna z węzłem CZ Vodná vodováha
 GB Water level RO Furtun de nivel
 D Schlauchwaage H Vizes vízmérték
 RUS Гидроуровень E Nivel de agua



No.	L (m)	size / rozmiar (mm)	
16000	15	10	15
16001	20	10	15
16002	25	10	15

- PL Waga sprężynowa z miarką zwijaną
 GB Spring weight measurer
 D Federwaage
 RUS Ручные пружинные весы
 CZ Váha pŕeřová
 RO Cântar cu arc și cârlig
 H Akasztós mérleg
 E Balanza de resorte

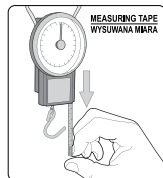

No.	max. lifting capacity / max. udźwig (kg)	
15301	32	36

- PL Waga sprężynowa
 GB Spring weight measurer
 D Federwaage
 RUS Ручные пружинные весы
 CZ Váha pŕeřová
 RO Cântar cu arc și cârlig
 H Akasztós mérleg
 E Balanza de resorte



No.	max. lifting capacity / max. udźwig (kg)	
15291	25	72
15292	50	48

- PL Lupa z opaską na głowę
 GB Head magnifier
 D Lupe mit Stirrband
 RUS Лупа биноклярная налобная
 CZ Lupa s hlavou
 RO Lupă cu cap
 H Fejpántos nagyító szett
 E Lupa con cabeza



No.	
73503	24

Memo	
------	--

13

Pneumatic tools Narzędzia pneumatyczne



Air tools Narzędzia pneumatyczne



196-199

Impact wrenches Klucze udarowe.....	196
Pneumatic grinders Szlifierki pneumatyczne.....	196
Pneumatic ratchets Grzechotki pneumatyczne.....	197
Ratchet air wrenches Klucze pneumatyczne.....	197
Pneumatic hammers Młotki pneumatyczne.....	198
Pneumatic cut-off tools Przecinarki pneumatyczne.....	198
Pneumatic shears Nożyce pneumatyczne.....	198
Pneumatic drills Wiertarki pneumatyczne.....	198
Multi-purpose air tools Wielofunkcyjne narzędzia pneumatyczne.....	199

Tire inflating guns & heads Pistolety do pompowania kół i głowice



199

Pneumatic painting equipment Narzędzia do malowania



199-205

Spray guns Pistolety lakiernicze.....	199
Blow guns Pistolety do przedmuchiwania.....	200
Washing guns Pistolety do ropowania.....	201
Pneumatic painting equipment GAV Narzędzia do malowania GAV.....	201

Pneumatic accessories Akcesoria instalacji pneumatycznej



205-207

Air filters, regulators & lubricators Filtry, reduktory i smarownice.....	205
Spiral hoses Węże spiralne.....	206
Reinforced hoses Węże zbrojone.....	206
Couplers Złącza.....	206

Pneumatic riveters Nitownice pneumatyczne



207

- PL Klucz pneumatyczny udarowy
- GB Impact wrench
- D Druckluft-Schlagschrauber
- RUS Гайковерт пневматический
- CZ Klíč pneumatický
- RO Pistol pneumatic
- H Pneumatikus ütvecsavarozó
- E Llave de percusión



1/2" 0.63
12.5mm MPa(max.)

0-7000 226
min l/min

340 Nm STANDARD

$L_{pa} = 92,6 \text{ dB}; L_{wa} = 103,6 \text{ dB}; a_n = 2,8 \text{ m/s}^2$



No.	size / rozmiar	l / min	Nm	
81100	1/2" (12.5 mm)	226	340	10

- PL Szlifierka pneumatyczna prosta
- GB Air grinder
- D Drucklufterhandschleifer
- RUS Прямая пневматическая шлифмашинка
- CZ Bruska přímá pneumatická
- RO Polizor pneumatic
- H Préslevegős sarokcsiszoló
- E Lijadera neumática recta

0.63 25000 100
MPa(max.) min l/min

Ø6mm STANDARD

13



$L_{pa} = 88,0 \pm 3,0 \text{ dB}; L_{wa} = 99,0 \pm 3,0 \text{ dB}; a_n = 2,9 \pm 1,5 \text{ m/s}^2$

No.	shank size / rozmiar uchwytu (mm)	l / min	min-1	
81107	6	100	25000	20

- PL Szlifierka pneumatyczna kątowa
- GB Air angle grinder
- D Druckluft-Winkelschleifer
- RUS Угловая шлифовальная машинка
- CZ Bruska úhlová vzduchová
- RO Polizor pneumatic
- H Préslevegős sarokcsiszoló
- E Lijadera neumática de ángulo

0.63 0-20000 100
MPa(max.) min l/min

Ø6mm STANDARD



$L_{pa} = 90,1 \text{ dB}; L_{wa} = 101,1 \text{ dB}; a_n = 0,7 \text{ m/s}^2$

No.	shank size / rozmiar uchwytu (mm)	l / min	min-1	
81110	6	100	20000	16

- PL Klucz pneumatyczny z nasadkami
- GB Air impact kit
- D Druckluft-Schlagschrauber mit Krafteinsätzen
- RUS Гайковерт пневматический + набор головок
- CZ Klíč pneumatický s nástavci
- RO Pistol pneumatic cu accesorii
- H Pneumatikus ütvecsavarozó készlet
- E Llave neumático de percusión



9 10 11 13 14 17
19 22 24 27 mm

1/2" 0.63
12.5mm MPa(max.)

0-7000 226
min l/min

340 Nm CrV

1/2" (12.5 mm) 125 mm STANDARD

MINI OILER OIL POT



$L_{pa} = 95,0 \pm 3,0 \text{ dB}; L_{wa} = 106,0 \pm 3,0 \text{ dB}; a_n = 9,1 \pm 1,5 \text{ m/s}^2$

No.	size / rozmiar	l / min	Nm	
81101	1/2" (12.5 mm)	226	340	5

- PL Szlifierka pneumatyczna prosta
- GB Air grinder
- D Drucklufterhandschleifer
- RUS Прямая пневматическая шлифмашинка
- CZ Bruska přímá pneumatická
- RO Polizor pneumatic
- H Préslevegős sarokcsiszoló
- E Lijadera neumática recta

0.63 0-22000 127
MPa(max.) min l/min

Ø6mm STANDARD



$L_{pa} = 82,8 \text{ dB}; L_{wa} = 93,8 \text{ dB}; a_n = 0,9 \text{ m/s}^2$

No.	shank size / rozmiar uchwytu (mm)	l / min	min-1	
81108	6	127	22000	20

- PL Szlifierka pneumatyczna prosta z akcesoriami
- GB Die grinder kit
- D Druckluft-Schrauber mit Schleifaufsätzen
- RUS Прямая пневматическая шлифмашинка + принадлежности
- CZ Bruska přímá pneumatická s příslušenstvím
- RO Masina de polizat pneumatica
- H Pneumatikus köszörű készlet
- E Lijadora neumática recta

0.63 0-22000 127
MPa(max.) min l/min

Ø3;6mm STANDARD

10 pcs



$L_{pa} = 88,0 \pm 3,0 \text{ dB}; L_{wa} = 99,0 \pm 3,0 \text{ dB}; a_n = 2,9 \pm 1,5 \text{ m/s}^2$

No.	shank size / rozmiar uchwytu (mm)	l / min	min-1	
81109	3; 6	127	22000	8

- PL Zestaw pneumatyczny szlifierka mini
- GB Air micro die grinder kit
- D Luft Sterben Schleifer Kit
- RUS Пневмошлифмашина мини в наборе
- CZ Pneumatická bruska mini
- RO Biax pneumatic tip stilou
- H Pneumatikus mini-csiszoló
- E Amoladora biax recta neumática

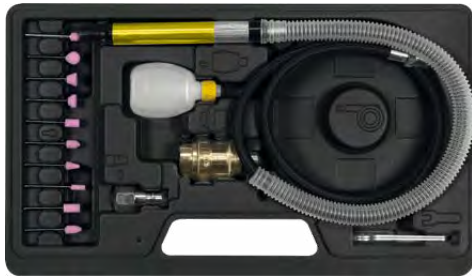

$L_{pa} = 79 \pm 3$ dB; $L_{ua} = 90 \pm 3$ dB; $a_h = < 2,5$ m/s²

No.	shank size / rozmiar uchwyty (mm)	min-1	
80970	3	0-54000	10

- PL Tarcza polerska do szlifiarki pneumatycznej
- GB Disc for air sander
- D Stützeiler für Druckluftexcenterschleifer
- RUS Диск для эксцентриковой шлифмашины
- CZ Disk pro pneumatickou brusku
- RO Masina disc pt. slefuit
- H Csiszolókorong pneumatikus gépekhez
- E Recambio disco lijadora orbital neumática



No.	Ø (mm)	min-1	
81115	150	0-10000	10/100

- PL Grzechotka pneumatyczna
- GB Ratchet air wrench
- D Druckluft-Ratschenschrauber
- RUS Пневмотрещотка
- CZ Utahovák vzduchový
- RO Antrenor pneumatic
- H Préslevegős behajtó szerszám
- E Carraca neumática

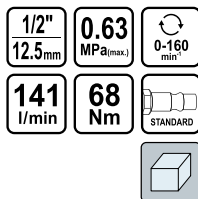

$L_{pa} = 91,0 \pm 3,0$ dB; $L_{ua} = 102,0 \pm 3,0$ dB; $a_h = 3,27 \pm 1,5$ m/s²

No.	size / rozmiar	l / min	Nm	
81118	1/2" (12.5 mm)	141	68	10

- PL Szlifierka pneumatyczna mimośrodowa
- GB Air sander
- D Druckluft- Excenterschleifer
- RUS Экцентриковая шлифмашина
- CZ Bruska pneumatická
- RO Masina de slefuit pneumatica
- H Pneumatikus sarokcsiszológép
- E Lijadera neumática excentrica



$L_{pa} = 72,7$ dB; $L_{ua} = 83,7$ dB; $a_h = 1,44$ m/s²

No.	Ø (mm)	min-1	
81114	150	0-10000	10

- PL Grzechotka pneumatyczna
- GB Ratchet air wrench
- D Druckluft-Ratschenschrauber
- RUS Пневматический гаечный ключ с трещоткой
- CZ Utahovák vzduchový
- RO Antrenor pneumatic
- H Préslevegős behajtó szerszám
- E Carraca neumática

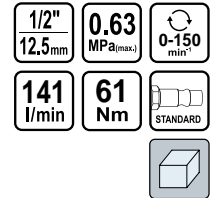

$L_{pa} = 92,1$ dB; $L_{ua} = 103,1$ dB; $a_h = 0,8$ m/s²

No.	size / rozmiar	l / min	Nm	
81117	1/2" (12.5 mm)	141	61	20

- PL Klucz pneumatyczny kątowy
- GB Ratchet air wrench
- D Druckluft-Ratschenschrauber
- RUS Пневматический гаечный ключ с храповиком
- CZ Utahovák vzduchový
- RO Antrenor pneumatic
- H Préslevegős behajtó szerszám
- E Llave neumático de ángulo con carraca

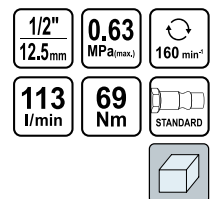

$L_{pa} = 94,0 \pm 3,0$ dB; $L_{ua} = 105,0 \pm 3,0$ dB; $a_h = 9,0 \pm 1,5$ m/s²

No.	size / rozmiar	l / min	Nm	
81119	1/2" (12.5 mm)	113	69	10

PL Miotek pneumatyczny CZ Sekáč vzduchový
 GB Air hammer RO Pneumatikus vésőkészlet pisztollyal
 D Druckluft-Schlaghammer H Kladivo pneumatické
 RUS Пневматический молоток E Marteau burineur

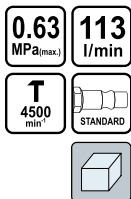

$L_{pa} = 85,0 \pm 3,0$ dB; $L_{wa} = 96,0 \pm 3,0$ dB; $a_h = 9,4 \pm 1,5$ m/s²

No.	l / min	min-1	cube
81133	113		8

PL Nożyce pneumatyczne matrycowe
 GB Air nibbler
 D Pneumatische Schere
 RUS Вырубные ножницы пневматические
 CZ Pneumatické nůžky na plech
 RO Foarfeca pneumatică
 H Pneumatikus folyamatos lyukasztó
 E Roedora neumática

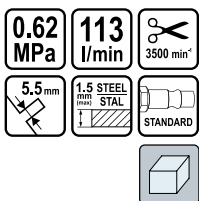

$L_{pa} = 77,0 \pm 3,0$ dB; $L_{wa} = 88,0 \pm 3,0$ dB; $a_h = 4,42 \pm 1,5$ m/s²

No.	l / min	min-1	cube
81070	113	3500	20

PL Nożyce pneumatyczne kątowe
 GB Air shears pistol type
 D Pneumatische Schere
 RUS Пневматические ножницы угловые
 CZ Pneumatické nůžky na plech
 RO Foarfeca pneumatică
 H Pneumatikus ollók
 E Tijera neumática



$L_{pa} = 77,0 \pm 3,0$ dB; $L_{wa} = 88,0 \pm 3,0$ dB; $a_h = 4,42 \pm 1,5$ m/s²

No.	l / min	min-1	cube
81073	184	2100	10

PL Przecinarka pneumatyczna CZ Příčná bruska pneumatická
 GB Air cut-off tool RO Masina de taiat cu aer comprimat
 D Druckluft-Schneidmaschine H Pneumatikus sarkocsiszóló
 RUS Резак пневматический E Cortadora neumática



$L_{pa} = 84,5 \pm 3,0$ dB; $L_{wa} = 95,5 \pm 3,0$ dB; $a_h = 2,45 \pm 1,5$ m/s²

No.	l / min	min-1	cube
81080	113	20000	20

PL Nożyce pneumatyczne kątowe
 GB Air shears pistol type
 D Pneumatische Schere
 RUS Пневматические ножницы угловые
 CZ Pneumatické nůžky na plech
 RO Foarfeca pneumatică
 H Pneumatikus ollók
 E Tijera neumática

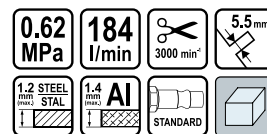

$L_{pa} = 77,0 \pm 3,0$ dB; $L_{wa} = 88,0 \pm 3,0$ dB; $a_h = 4,42 \pm 1,5$ m/s²

No.	l / min	min-1	cube
81072	184	3000	12

PL Wiertarka pneumatyczna
 GB Reversible air drill
 D Druckluft-Bohrmaschine
 RUS mit Stahl-Zahnkranzfutter Пневматическая дрель
 CZ Vrtáčka ruční vzduchová
 RO Masina de gaurit pneumatică mandrină
 H Préslevegős fűrógép
 E Perceuse réversible

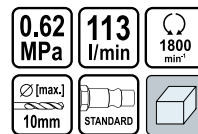

$L_{pa} = 94,2 \pm 3,0$ dB; $L_{wa} = 105,2 \pm 3,0$ dB; $a_h = 2,14 \pm 1,5$ m/s²

No.	l / min	min-1	cube
81122	113	1800	10

- PL Wielofunkcyjne narzędzie oscylacyjne pneumatyczne
 GB Multi-purpose oscillating air tool
 D Druckluft-Multifunktionswerkzeuge
 RUS Пневматический многофункциональный инструмент
 CZ Pneumatická oscilační multifunkční bruska
 RO Multifunctional oscilant pneumatic
 H Pneumatikus oszcilláló multifunkciós csiszoló
 E Estuche herramienta neumática multifunción

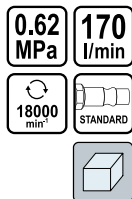

$L_{pa} = 87,5 \pm 3,0$ dB; $L_{wa} = 98,5 \pm 3,0$ dB; $a_s = 4,511 \pm 1,5$ m/s²

No.	l / min	min-1	
81060	170	18000	10

- PL Pistolet do pompowania
 GB Inflating gun
 D Inflatorpistole
 RUS Пистолет для накачивания
 CZ Pistole na čerpání z manometrem
 RO Pistol cu manometru pt. pompat
 H Pumpáló pisztoly nyomásmérővel
 E Pistola de bombeo con manómetro



$L_{pa} < 70$ dB; $a_s < 2,5$ m/s²

No.	
81650	10/40

- PL Głowica do pompowania
 GB Inflating head
 D Klemmnippel (universal)
 RUS Насадка на насос под шланг
 CZ Hlava na čerpání
 RO Cap pt. pompat
 H Pumpafej
 E Cabeza de bombeo



No.	connector / króciec Ø (mm)	
81653	8	50/300
81661	6	50/300

- PL Pistolet natryskowy
 GB Spray gun with fluid cup
 D Lackierpistole mit Fließbecher
 RUS Краскораспылитель нижний металлический бачок
 CZ Pistole na lakování z nádrží
 RO Pistol de vopsit cu rezervor inferior
 H Festőpisztoly alsó tartállyal
 E Pistola de barniz



$L_{pa} = 61,2$ dB; $L_{wa} = 72,2$ dB

No.	Ø (mm)	
80901	1.4	10

- PL Zestaw narzędzi pneumatycznych z akcesoriami
 GB Pneumatic tool set
 D Druckluftwerkzeugsatz mit Zubehör
 RUS Пневматический ударный инструмент в наборе
 CZ Sada pneumatického nářadí
 RO Set pistol + accesorii pneumatice
 H Légszerszámok készlet
 E Juego de herramientas neumáticas con accesorios



No.	size / rozmiar	shank size / rozmiar uchwyty (mm)	pcs	
81142	1/2" (12.5 mm)	6	33	2

- PL Pistolet do pompowania
 GB Inflating gun
 D Inflatorpistole
 RUS Пистолет для накачивания
- CZ Pistole na čerpání z manometrem
 RO Pistol cu manometru pt. pompat
 H Pumpáló pisztoly nyomásmérővel
 E Pistola de bombeo con manómetro



$L_{pa} = 88 \pm 3$ dB; $L_{wa} = 99 \pm 3$ dB; $a_s < 2,5$ m/s²

No.	
81651	30

- PL Pistolet natryskowy
 GB Spray gun with fluid cup
 D Lackierpistole mit Fließbecher
 RUS Краскораспылитель верхний бак
 CZ Pistole na lakování z nádrží
 RO Pistol de vopsit cu rezervor inferior
 H Festőpisztoly alsó tartállyal
 E Pistola de barniz



$L_{pa} = 58,2$ dB; $L_{wa} = 69,2$ dB

No.	Ø (mm)	
80902	1.4	10

- PL Pistolet natryskowy
- GB Spray gun with fluid cup
- D Lackierpistole mit Fließbecher
- RUS Краскораспылитель верхний бак
- CZ Pistolet na lakování z nádrží
- RO Pistol de vopsit cu rezervor inferior
- H Festópisztoly alsó tartállyal
- E Pistola de barniz



1.8mm	0.35 MPa
198 l/min	1.0 l
HVLP	STANDARD

$L_{PA} = 85 \pm 2.5$ dB; $L_{WA} = 98.9 \pm 2.5$ dB



No.	Ø (mm)	
80903	1.8	10

- PL Pistolet natryskowy
- GB Spray gun with fluid cup
- D Lackierpistole mit Fließbecher
- RUS Краскораспылитель верхний бак
- CZ Pistolet na lakování z nádrží
- RO Pistol de vopsit cu rezervor inferior
- H Festópisztoly alsó tartállyal
- E Pistola de barniz



1.5mm	0.4 MPa
450 l/min	0.68 l

$L_{WA} < 70$ dB; $a_h < 2.5$ dB



No.	Ø (mm)	
81618	1.5	20

- PL Zestaw lakierniczy
- GB Spray gun kit
- D Lackierspritzsatz
- RUS Набор покрасочный пневматический
- CZ Laková souprava
- RO Set de lacuit
- H Részcs fényezőkészlet
- E Juego de barniz

5 PCS



3-6 bar, L=400 mm	3-5 bar, 950ml
3-5 bar	3,5-5bar, 750ml, ø1,5mm, 280-450 l/min L=5m



No.	pcs	
81638	5	10

- PL Pistolet natryskowy
- GB Spray gun with fluid cup
- D Lackierpistole mit Fließbecher
- RUS Краскораспылитель нижний металлический бачок
- CZ Pistolet na lakování z nádrží
- RO Pistol de vopsit cu rezervor inferior
- H Festópisztoly alsó tartállyal
- E Pistola de barniz



1.5mm	0.4 MPa
450 l/min	1.0 l
STANDARD	

$L_{WA} < 70$ dB; $a_h < 2.5$ dB



No.	Ø (mm)	
81617	1.5	20

- PL Zestaw lakierniczy
- GB Spray gun kit
- D Lackierspritzsatz
- RUS Набор покрасочный пневматический
- CZ Laková souprava
- RO Set de lacuit
- H Részcs fényezőkészlet
- E Juego de barniz

5 PCS



3-6 bar, L=400 mm	3-5 bar, 950ml
3-5 bar	3,5-5bar, 750ml, ø1,5mm, 280-450 l/min L=5m



No.	pcs	
81637	5	10

- PL Pistolet do przedmuchiwania
- GB Blow gun
- D Ausblaspistole
- RUS Пистолет для продувки короткий
- CZ Pistolet na profukování kratká
- RO Pistol scurt pt. suflat
- H Pövid előlefuvo pisztoly
- E Pistola de soplado

0.8 MPa (max.)
STANDARD



$L_{PA} = 91 \pm 3$ dB; $L_{WA} = 102 \pm 3$ dB; $a_h < 2.5$ m/s²

No.	L (mm)	
81631	100	10/40

- PL Pistolet do przedmuchiwania CZ Pistole na profukování kratká
 GB Blow gun RO Pistol scurt pt. suflat
 D Ausblaspistole H Pövid előléfűvő pisztoly
 RUS Пистолет для продувки короткий E Pistola de soplado



$L_{pA} = 91 \pm 3$ dB; $L_{wA} = 102 \pm 3$ dB; $a_h < 2,5$ m/s²

No.	L (mm)	Box
81632	200	10/40

- PL Pistolet do przedmuchiwania CZ Pistole na profukování kratká
 GB Blow gun RO Pistol scurt pt. suflat
 D Ausblaspistole H Pövid előléfűvő pisztoly
 RUS Пистолет для продувки короткий E Pistola de soplado

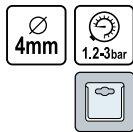

$L_{wA} = < 70$ dB; $a_h < 2,5$ m/s²

No.	Box
81640	20/40

- PL Pistolet do przedmuchiwania z przedłużką CZ Pistole na profukování dlouhá
 GB Blow gun with extension RO Pistol lung pt. suflat
 D Gebiäspistole mit Verlängerung H Rövid előléfűvő pisztoly
 RUS Пистолет для продувки длинный E Pistola de soplado



$L_{wA} = < 70$ dB; $a_h < 2,5$ m/s²

No.	Box
81644	20/40

- PL Pistolet do ropowania CZ Pistole na ropování
 GB Washing gun RO Pistol (dozator) pt. motorină
 D Waschpistole H Olajzópisztoly
 RUS Пистолет для нефтевания E Pistola de petroler



$L_{wA} = < 70$ dB; $a_h < 2,5$ m/s²

No.	Box
81647	10/20

- PL Pistolet do przedmuchiwania CZ Pistole na profukování kratká
 GB Blow gun RO Pistol scurt pt. suflat
 D Ausblaspistole H Pövid előléfűvő pisztoly
 RUS Пистолет для продувки короткий E Pistola de soplado



$L_{pA} = 91 \pm 3$ dB; $L_{wA} = 102 \pm 3$ dB; $a_h < 2,5$ m/s²

No.	L (mm)	Box
81633	300	20/40

- PL Pistolet do przedmuchiwania CZ Pistole na profukování kratká
 GB Blow gun RO Pistol scurt pt. suflat
 D Ausblaspistole H Pövid előléfűvő pisztoly
 RUS Пистолет для продувки короткий E Pistola de soplado



$L_{wA} = < 70$ dB; $a_h < 2,5$ m/s²

No.	Box
81643	100

- PL Zestaw do przedmuchiwania CZ Pneumatická čističí pistole sada
 GB Air blow gun kit RO Pistol aer curatat praful cu furton
 D Ausblaspistole Druckluft Set H Fuvató pisztoly szett
 RUS Набор для продувки E Kit pistola de aire aire bobina



$L_{pA} = 90$ dB; $L_{wA} = 101$ dB; $a_h = < 2,5$ m/s²

No.	Box
81634	10/20

- PL Pistolet natryskowy CZ Pistole na lakování z nádrží
 GB Spray gun with fluid cup RO Pistol de vopsit cu rezervor inferior
 D Lackierpistole mit Fließbecher H Festőpisztoly alsó tartállyal
 RUS Краскораспылитель верхний бак E Pistola de barniz



No.	l	MPa	Box
GV-0083	1	0.4-0.8	20

- PL Pistolet natryskowy
- GB Spray gun with fluid cup
- D Lackierpistole mit Fließbecher
- RUS Краскораспылитель верхний бак
- CZ Pistole na lakování z nádrží
- RO Pistol de vopsit cu rezervor inferior
- H Festőpisztoly alsó tartállyal
- E Pistola de barniz



No.	l	MPa	
GV-0062	0.75	0.4-0.8	20

- PL Pistolet do przedmuchiwania
- GB Blow gun with extension
- D Gebläsepistole mit Verlängerung
- RUS Пистолет для продувки (короткий)
- CZ Pistole na profukování dlouhá
- RO Pistol lung pt. suflat
- H Rövid előlefvő pisztoly
- E Pistola de soplado



No.	MPa	
GV-0400	0-1.2	100

- PL Pistolet do ropowania
- GB Washing gun
- D Waschpistole
- RUS Пистолет для нефтявания
- CZ Pistole na ropování
- RO Pistol (dozator) pt. motorină
- H Olajzöpisztoly
- E Pistola de petrolcar



No.	MPa	
GV-0510	0-1.2	18

- PL Pistolet do pompowania
- GB Inflating gun
- D Inflatorpistole
- RUS Пистолет для накачивания
- CZ Pistole na čerpání z manometrem
- RO Pistol cu manometru pt. pompat
- H Pumpáló pisztoly nyomásmérővel
- E Pistola de bombeo con manómetro



No.	MPa	
GV-0620	0-1	100

- PL Pistolet natryskowy
- GB Spray gun with fluid cup
- D Lackierpistole mit Fließbecher
- RUS Краскораспылитель нижний металлический бачок
- CZ Pistole na lakování z nádrží
- RO Pistol de vopsit cu rezervor inferior
- H Festőpisztoly alsó tartállyal
- E Pistola de barniz



No.	l	MPa	
GV-0082	1	0.4-0.8	20

- PL Pistolet do przedmuchiwania
- GB Blow gun with extension
- D Gebläsepistole mit Verlängerung
- RUS Пистолет для продувки длинный
- CZ Pistole na profukování dlouhá
- RO Pistol lung pt. suflat
- H Rövid előlefvő pisztoly
- E Pistola de soplado



No.	MPa	
GV-0420	0-1.2	200

- PL Pistolet do pompowania
- GB Inflating gun
- D Inflatorpistole
- RUS Пистолет для накачивания
- CZ Pistole na čerpání z manometrem
- RO Pistol cu manometru pt. pompat
- H Pumpáló pisztoly nyomásmérővel
- E Pistola de bombeo con manómetro



No.	MPa	
GV-0610	0-1.2	100

- PL Pistolet do pompowania
- GB Inflating gun
- D Inflatorpistole
- RUS Пистолет для накачивания
- CZ Pistole na čerpání z manometrem
- RO Pistol cu manometru pt. pompat
- H Pumpáló pisztoly nyomásmérővel
- E Pistola de bombeo con manómetro



No.	MPa	
GV-0631	0-1.2	25

- PL Glowica do pompowania CZ Hlava na čerpání
 GB Universal head RO Cap pt. pompat
 D Klemmnippel (universal) H Pumpafej
 RUS Насадка на насос под шланг E Cabeza de bombeo



No.	connector / króciec Ø (mm)	
GV-0656	6	500/1500
GV-0658	8	250/1000

- PL Pistolet do piaskowania z wężem CZ Piskovací pistole s hadicí
 GB Air sand blaster RO Pistol de sablat
 D Pistole zum sandstrahlen H Homokszóró pisztoly tömlővel
 RUS Пескоструйный пистолет E Pistola para limpieza con chorro de arena con manguera



No.	MPa	m	
GV-0710	0.6-0.8	2	50

- PL Pistolet do konserwacji CZ Konzervační pistole
 GB Gun for protection and sound-roofing treatments RO Pistol pt. întreţinere
 D Spitzpistole für Flächenschutzfluide H Karbantartó pisztoly
 RUS Пистолет для консервирования E Pistola de conservar sin recipiente



No.	MPa	
GV-0730	0.6-0.8	100

- PL Filtr - reduktor CZ Filtr derukční ventil
 GB Filter - reducer RO Filtru cu reductor
 D Druckfilter - Druckminderer H Szűrő - nyomákszabályzó
 RUS Фильтр - редуктор E Reductor + filtro



No.	MPa max.	thread size / rozmiar gwintu	
GV-0861	1.6	G1/2	20

- PL Pistolet do piaskowania ze zbiornikiem CZ Piskovací pistole se zásobníkem
 GB Gun suitable for sand-blasting RO Pistol de sablat
 D Sandstrahlpistole H Homokszóró pisztoly tartállyal
 RUS Пескоструйный пистолет E Pistola para limpieza con chorro de arena con recip.



No.	l	MPa	
GV-0700	1	0.6-0.8	100

- PL Pistolet do konserwacji CZ Konzervační pistole
 GB Gun for sound-deadening treatments RO Pistol pt. întreţinere
 D Spitzpistole für Flächenschutzfluide H Karbantartó pisztoly
 RUS Пистолет для консервирования E Pistola de conservar con recipiente



No.	l	MPa	
GV-0720	1	0.6-0.8	100

- PL Pistolet do konserwacji z wężem CZ Konzervační pistole s hadicí
 GB Gun for protection and sound-roofing treatments RO Pistol pt. întreţinere, cu furtun
 D Spitzpistole für Flächenschutzfluide H Karbantartó pisztoly tömlővel
 RUS Пистолет для консервирования E Pistola de conservar sin recipiente con manguera



No.	MPa	
GV-0740	0.6-0.8	75

- PL Zespół filtrujący, reduktor + smarownica CZ Redukční ventil s odlučovačem oleje
 GB Air filter regulator and lubricator RO Filtru cu reductor
 D Druckfilter-Druckminderer - Entöler H Levegőelőkészítő
 RUS Фильтр-редуктор + смазочный прибор E Juego de filtro reductor + engrasador



No.	MPa max.	thread size / rozmiar gwintu	
GV-0871	1.6	G1/2	18

- PL Reduktor ciśnienia z manometrem
 GB Pressure reducing valve with manometer
 D Druckminderer mit Manometer
 RUS Регулятор давления с манометром
- CZ Redukční ventil s manometrem
 RO Valva cu reductiepresiune + manometru
 H Nyomáscsökkentő szelep nyomásmérővel
 E Reductor + manometro



No.	MPa max.	
GV-0925	1.2	100

- PL Szybkozłącze
 GB Quick coupler
 D Schnellkupplung
 RUS Быстроразъемное соединение на шланг

- CZ Rychlospojka
 RO Mufa rapida pt. pistol pneumatic
 H Gyorscsatlakozó
 E Conexión de la entrada de aire



No.	connector / króciec Ø (mm)	
GV-1121	6	100/300
GV-1122	8	100/300
GV-1123	10	100/300

- PL Szybkozłącze
 GB Quick coupler
 D Schnellkupplung
 RUS Быстроразъемная муфта с наружной резьбой

- CZ Rychlospojka
 RO Mufa rapida pt. pistol pneumatic
 H Gyorscsatlakozó
 E Conexión de la entrada de aire



No.	thread size / rozmiar gwintu	
GV-1150	G1/4	100/400
GV-1151	G3/8	100/400
GV-1152	G1/2	100/400

- PL Szybkozłącze
 GB Quick coupler
 D Schnellkupplung
 RUS Быстроразъемное соединение на шланг

- CZ Rychlospojka
 RO Mufa rapida pt. pistol pneumatic
 H Gyorscsatlakozó
 E Conexión de la entrada de aire



No.	connector / króciec Ø (mm)	
GV-1180	6	100/400
GV-1181	8	100/400
GV-1182	10	100/400

- PL Szybkozłącze
 GB Quick coupler
 D Schnellkupplung
 RUS Быстроразъемная муфта с наружной резьбой

- CZ Rychlospojka
 RO Mufa rapida pt. pistol pneumatic
 H Gyorscsatlakozó
 E Conexión de la entrada de aire



No.	thread size / rozmiar gwintu	
GV-1100	G1/4	100/300
GV-1101	G3/8	100/300
GV-1102	G1/2	100/300

- PL Szybkozłącze
 GB Quick coupler
 D Schnellkupplung
 RUS Быстроразъемное соединение с внутренней резьбой

- CZ Rychlospojka
 RO Mufa rapida pt. pistol pneumatic
 H Gyorscsatlakozó
 E Conexión de la entrada de aire



No.	thread size / rozmiar gwintu	
GV-1105	G1/4	100/300

- PL Szybkozłącze
 GB Quick coupler
 D Schnellkupplung
 RUS Быстроразъемное соединение с внутренней резьбой

- CZ Rychlospojka
 RO Mufa rapida pt. pistol pneumatic
 H Gyorscsatlakozó
 E Conexión de la entrada de aire



No.	thread size / rozmiar gwintu	
GV-1160	G1/4	100/400
GV-1161	G3/8	100/400

- PL Szybkozłącze
 GB Quick coupler
 D Schnellkupplung
 RUS Быстроразъемное соединение с наружной резьбой

- CZ Rychlospojka
 RO Mufa rapida pt. pistol pneumatic
 H Gyorscsatlakozó
 E Conexión de la entrada de aire



No.	thread size / rozmiar gwintu	
GV-1200	G1/4	500/2000
GV-1201	G3/8	500/1000
GV-1202	G1/2	250/1000

- PL Szybkozłącze CZ Rychlospojka
 GB Quick coupler RO Mufa rapida pt. pistol pneumatic
 D Schnellkupplung H Gyorscsatlakozó
 RUS Быстроразъемное соединение (штуцер), внутренняя резьба E Conexión de la entrada de aire

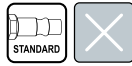

No.	thread size / rozmiar gwintu	
GV-1220	G1/4	500/1000
GV-1221	G3/8	500/1000

- PL Gwint stożkowy CZ Vsuвка s kuželovým závitem
 GB Taper reducer RO Reducție
 D Verlängerungsrippel H Kúpos menet
 RUS Нипель 1/4"-1/4" E Junta nypel rosca cónica



No.	thread size / rozmiar gwintu	
GV-1272	G1/4	100/2000

- PL Złącze króciec do węża CZ Spojky – nátrubek pro hadici
 GB Male hose adapter RO Adaptor furtun
 D Schauchtülle mit Aussengewinde H Csatlakozó csőcsonk tömlőhöz
 RUS Штуцер „елочка” с наружной резьбой E Junta tubo corto para manguera 6 rosca exter



No.	thread size / rozmiar gwintu	connector / króciec Ø (mm)	L (mm)	
GV-1382	G1/4	6	33	500/1500
GV-1384	G1/4	8	33	600
GV-1385	G3/8	8	34	100/1000
GV-1386	G3/8	10	34	100/1200
GV-1387	G1/2	10	37	250/1000
GV-1388	G1/4	10	35	500

- PL In-line air tool oiler CZ Olejnička do pneumatických nářadí
 GB Öler für Druckluftwerkzeuge RO Gresor scule pneumatice
 D Naolejacz do narzędzi pneumatycznych H Pneumatikus szerszám olajozó
 RUS Масленка для пневматического инструмента E Lubricador para herramientas neumáticas



No.		
81570		20/100

- PL Szybkozłącze CZ Rychlospojka
 GB Quick coupler RO Mufa rapida pt. pistol pneumatic
 D Schnellkupplung H Gyorscsatlakozó
 RUS Быстроразъемное соединение (штуцер), „елочка” с обжимным кольцом E Conexión de la entrada de aire

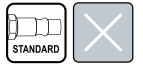

No.	connector / króciec Ø (mm)	
GV-1240	6	500/1500
GV-1241	8	500/2000
GV-1242	10	500/1500

- PL Złącze bagnetowe do węży CZ Spojky hadicové bajonetové
 GB Bayonet coupling for rubber pipes RO Conector levi
 D Bajonettverschluss für gummschläuche H Bajonett csatlakozó tömlőhöz
 RUS Переходник „елочка на елочку” E Junta de bayoneta para manguera de goma



No.	connector / króciec Ø (mm)	
GV-1582	8	100/800
GV-1583	10	600

- PL Filtr CZ Filtr
 GB Filter RO Minifiltr
 D Filtr H Szűrő
 RUS Фильтр воздушный мини E Filtró

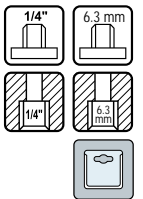

No.	thread size / rozmiar gwintu	
81560	G1/4	10/50

- PL Reduktor ciśnienia z manometrem CZ Redukční ventil s manometrem
 GB Pressure reducing valve with manometer RO Valva cu reducatiepresiune + manometru
 D Druckminderer mit Manometer H Nyomáscsökkentő szelep nyomásmérővel
 RUS Регулятор давления с манометром E Reductor + manometro



No.	thread size / rozmiar gwintu	
81562	G3/8	50

- PL Filtr - reduktor
GB Filter - reducer
D Druckfilter - Druckminderer
RUS Фильтр - редуктор
- CZ Filtr derukční ventil
RO Filtru cu reduktor
H Szűrő - nyomáscsökkentő
E Reductor + filtro



VOREL

No.	thread size / rozmiar gwintu	20
81553	G1/2	20

- PL Wąż spiralny PE z szybkoszłączami
GB PE spiral tubes with rapid couplings
D Spiralschlauch mit Schnellkupplung
RUS Шланг спиральный с быстроразъемным соединением
- CZ Spirální hadice
RO Furtun în spirală
H Spiráltömlő
E Manguera espiral

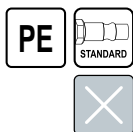

VOREL

No.	mm	L (m)	50
81490	5x8	5	50
81491	5x8	10	25
81492	5x8	15	25

- PL Wąż zbrojony
GB Armoured hose
D Schlauch, verstärkt durch Bewehrung
RUS Шланг армированный для подачи воздуха
- CZ Hadice vyztužená
RO Furtun în armat
H Fémbetétes tömlő
E Manguera armada



No.	Ø (mm)	L (m)	wall thickness / grubość ścianki	ATM	1
81519	6	50	2.5	10/40	1
81520	8	50	2.5	10/40	1
81521	10	50	2.5	10/40	1
81522	12	50	2.5	10/40	1
81523	14	50	3.0	10/40	1
81524	16	50	3.0	10/40	1
81525	19	50	3.5	10/40	1
81527	25	50	4.0	10/40	1

- PL Zespół filtrujący, reduktor + smarownica
GB Air filter regulator and lubricator
D Druckfilter-Druckminderer - Entöler
RUS Фильтр-редуктор + смазочный прибор
- CZ Redukční ventil s odlučovačem oleje
RO Filtru cu reduktor
H Levegőkészítő
E Juego de filtro reductor + engrasador



VOREL

No.	thread size / rozmiar gwintu	20
81556	G1/2	20

- PL Wąż spiralny PU z szybkoszłączami
GB PU spiral tubes with rapid couplings
D Spiralschlauch mit Schnellkupplung
RUS Шланг спиральный с быстроразъемным соединением
- CZ Spirální hadice
RO Furtun în spirală
H Spiráltömlő
E Manguera espiral

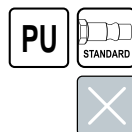

VOREL

No.	mm	L (m)	50
81500	5x8	5	50
81501	5x8	10	25
81502	5x8	15	25

- PL Szybkoszłącze
GB Quick coupler
D Schnellkupplung
RUS Быстроразъемная муфта с наружной резьбой
- CZ Rychlospojka
RO Mufa rapidă pt. pistol pneumatic
H Gyorscsatlakozó
E Conexión de la entrada de aire



VOREL

No.	thread size / rozmiar gwintu	50/250
81370	G1/4	50/250
81371	G3/8	50/250
81372	G1/2	50/250

- PL Szybkoszłącze
GB Quick coupler
D Schnellkupplung
RUS Быстроразъемное соединение с внутренней резьбой
- CZ Rychlospojka
RO Mufa rapidă pt. pistol pneumatic
H Gyorscsatlakozó
E Conexión de la entrada de aire

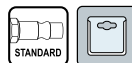

VOREL

No.	thread size / rozmiar gwintu	50/250
81373	G1/4	50/250
81374	G3/8	50/250

14

Special automotive tools & equipment Narzędzia i wyposażenie warsztatu samochodowego



Cabinets Szafki

210-214



Roller cabinets with tools insert

Szafki serwisowe z narzędziami..... 210

Tool cabinets

Szafki serwisowe..... 213

Trolley tool boxes

Wózki narzędziowe..... 214

Lubrication tools

Narzędzia do smarowania

215-218



Grease guns & oil transfer pumps

Smarownice ręczne i pompy transferowe do oleju..... 215

Manual oil pumps

Pompy ręczne do oleju..... 216

Oil cans

Oliwiarki..... 217

Oil filter wrenches

Klucze do filtra oleju..... 217

Pullers

Ściągacze

218-219



Gear pullers

Ściągacze do łożysk..... 218

Spring pullers

Ściągacze do sprężyn..... 219

Ball joint removers

Ściągacze do sworzni kulistych..... 219

Workshop tools

Narzędzia warsztatowe

219-230



Wheel wrenches

Klucze do kół..... 219

Piston ring compressors

Zaciskacze do pierścieni..... 220

Spark plug sockets

Klucze do świec..... 220

Flare nut wrenches

Klucze do przewodów hamulcowych..... 221

Paint thickness & car voltage testers

Tester grubości lakieru i samochodowe próbniki napięcia..... 221

Magnetic pick up tools

Chwytyki magnetyczne..... 221

Workshop seats

Taborety warsztatowe..... 222

Workshop creepers

Leżanki warsztatowe..... 222

Impact wrenches

Klucze udarowe..... 222

Workshop lamps

Lampy warsztatowe..... 223

Bottle & floor jacks

Dźwigniki słupkowe i podnośniki..... 226

Scissors jacks

Podnośniki mechaniczne..... 227

Jack stands

Podstawki pod samochód..... 228

Porta power kits

Rozpieraki hydrauliczne..... 228

Pull-back rams

Ściągacze blacharskie hydrauliczne..... 228

Battery chargers

Prostowniki..... 229

Tire pressure gauges

Mierniki ciśnienia..... 229

Chain blocks

Wciągarki łańcuchowe..... 230

Car accessories

Akcesoria samochodowe

230-239



Pumps

Pompy..... 230

Air compressors

Kompresory..... 231

Tow ropes

Linki holownicze..... 231

Battery clamp cleaners

Szczotki do czyszczenia klem..... 232

Battery hydrometers

Próbniki akumulatorowe..... 233

Booster cables

Wiązki przewodów awaryjnych..... 233

Scrapers & brushes

Skrabaczki i szczotki..... 233

Flexible funnels

Lejki..... 233

Car vacuum cleaners

Odkurzacze samochodowe..... 234

Portable shower sets

Prysznice turystyczne..... 235

First aid kits

Apteczki..... 235

Safety triangles

Trójkąty ostrzegawcze..... 236

Ratchet tie downs

Taśmy do bagażu..... 236

Tarpaulins & accessories

Plandeki i akcesoria..... 238

PL Szafka serwisowa z narzędziami
 GB Service tool cabinet with tools
 D Serviceschrank mit Werkzeugen
 RUS Сервисный шкаф с инструментами
 CZ Servisní skříňka s nářadím
 RO Dulap echipat cu scule
 H Szervizszekrény szerszámokkal
 E Armario para herramientas de servicio

177 PCS TRAY WPKŁAD
 12x 901x770x458mm
 6x
 WHEEL POLYUR
 2x BRAKE HAMULCE
 BALL BEARING ŁOŻYSKA KULKOWE
 NON SLIP WORKTOP BLAT ANTYPOŚLIZGOWY
 DRAWERS LOCKING BLOKADA SZUFLAD
 CENTRAL LOCK CENTRALNY ZAMEK
 2x
 CORNER BUMPERS NARÓŻNE ODBOJNIKI



14

12 interchangeable trays with tools
 12 wymiennych modułów z narzędziami



No.	drawers / szuflady	
58540	6	1

DRAWER / SZUFLADA 1

1/2" (12.7 mm): 10, 11, 12, 13, 14, 15, 16, 17, 18, 19, 20, 21, 22, 23, 24, 27, 30, 32 mm; CrV 50BV30; 1/2" (12.7 mm); (127 mm); CrV 50BV30; 1/2" (12.7 mm); CrV 50BV30; 1/2" (12.7 mm); (255 mm); 72T; CrV 6140; 1/2" (12.7 mm); (255 mm); CrV 50BV30; 1/2" (12.7 mm); 16; 21 mm; CrV 50BV30

3/8" (9.5 mm): 6, 7, 8, 9, 10, 11, 12, 13, 14, 15, 16, 17, 18, 19, 20, 21, 22 mm; CrV 50BV30; 3/8" (9.5 mm); (76.152.4 mm); CrV 50BV30; 3/8" (9.5 mm); CrV 50BV30; 3/8" (9.5 mm); (200 mm); 72T; CrV 6140; 3/8" (9.5 mm); (198 mm); CrV 50BV30

1/4" (6.3 mm): 3.5, 4, 4.5, 5, 5.5, 6, 7, 8, 9, 10, 11, 12, 13, 14 mm; CrV 50BV30; 1/4" (6.3 mm); 8, 10, 11, 12, 13 mm; CrV 50BV30; 1/4" (6.3 mm); (50.8, 101.6 mm); CrV 6140; 1/4" (6.3 mm); CrV 50BV30; 1/4" (6.3 mm); (155 mm); 72T; CrV 6140; 1/4" (6.3 mm); (150 mm); CrV 50BV30; 1/4" (6.3 mm); (152.4 mm); CrV 50BV30

DRAWER / SZUFLADA 2

3x75 mm, 5x100 mm, 5x150 mm, 6x38 mm, 6x100 mm, 6x150 mm, 8x150 mm; CrV;
 PH0x100 mm, PH1x75 mm, PH1x100 mm, PH2x38 mm, H2x100 mm, PH2x150 mm, PH3x150 mm; CrV;
 180 mm; 160 mm; 160 mm;
 160 mm BENT / WYGIĘTE

DRAWER / SZUFLADA 3

6x7, 8x9, 10x11, 12x13, 14x15, 16x17, 18x19 mm
 22, 24, 27, 28, 30, 32 mm; 6, 7, 8, 9, 10, 11, 12, 13, 14, 15, 16, 17, 18, 19, 20, 21 mm

DRAWER / SZUFLADA 4

1/2" (12.7 mm): 8, 9, 10, 11, 12, 13, 14, 15, 16, 17, 18, 19, 20, 21 mm (L=76 mm); CrV 50BV30;
 1/2" (12.7 mm), 3/8" (9.5 mm): H4, H5, H6, H7, H8, H10, H12 (L=30 mm); H4, H5, H6, H7, H8, H10, H12 (L=75 mm); CrV; M5, M6, M7, M10, M12 (L=30 mm); M5, M6, M7, M10, M12 (L=75 mm); CrV; T20, T25, T30, T40, T45, T50, T55 (L=30 mm); T20, T25, T30, T40, T45, T50, T55 (L=75 mm); CrV;
 300 g (L=300 mm); 40 mm (L=300 mm); 10x8x142 mm, 12x10x152 mm, 16x13x170 mm

- PL Szafka serwisowa z narzędziami
- GB Service tool cabinet with tools
- D Serviceschrank mit Werkzeugen
- RUS Сервисный шкаф с инструментами
- CZ Servisní skříňka s náradím
- RO Dulap echipat cu scule
- H Szerviszszekrény szerszámokkal
- E Armario para herramientas de servicio

184 PCS 9 TRAYS WKLADOW	900x840 x460mm
6x	2x
BALL BEARING ŁOŻYSKA KULKOWE	NON SLIP POLYPROPYLENE WORKTOP ANTYPOŚLIZGOWY BLAT
2x BRAKE HAMULCE	DRAWERS LOCKING BLOKADA SZUFLAD
Ø 125 mm	SIDE CUPBOARD BOCZNY SZKAFKOWY



9 interchangeable trays with tools
9 wymiennych modułów z narzędziami



DRAWER / SZUFLADA 1

1/2" (12.7 mm): 10, 11, 12, 13, 14, 15, 16, 17, 18, 19, 20, 21, 22, 23, 24, 27, 30, 32 mm; CrV 50BV30; 1/2" (12.7 mm); (127 mm); CrV 50BV30; 1/2" (12.7 mm); CrV 50BV30; 1/2" (12.7 mm); (255 mm); 45T; CrV 6140; 1/2" (12.7 mm); (255 mm); CrV 50BV30; 1/2" (12.7 mm); 16; 21 mm; CrV 50BV30

1/4" (6.3 mm): 3.5, 4, 4.5, 5, 5.5, 6, 7, 8, 9, 10, 11, 12, 13, 14 mm; CrV 50BV30; 1/4" (6.3 mm): 8, 10, 11, 12, 13 mm; CrV 50BV30; 1/4" (6.3 mm); (50.8, 101.6 mm); CrV 6140; 1/4" (6.3 mm); CrV 50BV30; 1/4" (6.3 mm); (155 mm); 45T; CrV 6140; 1/4" (6.3 mm); (150 mm); CrV 50BV30; 1/4" (6.3 mm); (152.4 mm); CrV 50BV30

5/32" (4 mm); CrV 6150; 5/32" (4 mm); CrV 6150; 5/32" (4 mm): 1.0, 1.5, 2.0, 2.5, 3.0, 3.5 mm; CrV 6150; 5/32" (4 mm): PH000, PH00, PH0, PH1; CrV 6150; 5/32" (4 mm): PZ0, PZ1; CrV 6150; 5/32" (4 mm): T4, T5, T6, T7, T8, T9, T10, T15, T20; CrV 6150; 5/32" (4 mm): 0.7, 0.9, 1.3, 2.0, 2.5, 3.0, 4.0, mm; CrV 6150; 5/32" (4 mm): 2.5, 3.0, 3.5, 4.0, 4.5, 5.0, 5.5 mm; CrV; 2.0, 2.5, 3.0, 4.0, 5.0, 5.5, 6.0, 8.0, 10.0, mm; CrV; T10, T15, T20, T25, T27, T30, T40, T45, T50; CrV

DRAWER / SZUFLADA 2

180mm; 160 mm; 160 mm; bent / wygięte; 160 mm

3/8" (9.5 mm): 4, 5, 6, 7, 8, 10, 12 mm (L=30 mm); 4, 5, 6, 7, 8, 10, 12 mm (L=75 mm); CrV; 3/8" (9.5 mm): M5, M6, M7, M10, M12 (L=30 mm); M5, M6, M7, M10, M12 (L=75 mm); CrV; 1/2" (12.7 mm) x 3/8" (9.5 mm); 3/8" (9.5 mm) x 3/8" (9.5 mm); 3/8" (9.5 mm): T20, T25, T30, T40, T45, T50, T55 (L=30 mm); T20, T25, T30, T40, T45, T50, T55 (L=75 mm); CrV;

3x75 mm, 5x100 mm, 6x100 mm, 8x150 mm; CrV; PH0x75 mm, PH1x100 mm, PH2x100 mm, PH3x150 mm; CrV;

DRAWER / SZUFLADA 3

6, 7, 8, 9, 10, 11, 12, 13, 14, 15, 16, 17, 18, 19, 20, 21, 22, 24, 27, 28, 30, 32 mm

300g, (L=300 mm); Ø 40 mm (L=310 mm); 10x8x142 mm, 12x10x152 mm, 16x13x170 mm;



No.	drawers / szuflady	
58560	6	1

PL Szafka serwisowa z narzędziami
 GB Service tool cabinet with tools
 D Serviceschrank mit Werkzeugen
 RUS Сервисный шкаф с инструментами
 CZ Servisní skříňka s náradím
 RO Dulap echipat cu scule
 H Szervizszekrény szerszámokkal
 E Armario para herramientas de servicio

302 PCS 12 TRAY WKŁAD
 2x1
 6x
 DRAWERS LOCKING BLOKADA SZUFLAD
 2x BRAKE HAMULCE
 125 mm
 CORNER BUMPERS NARÓZNE ODBOJNIKI
 901x770 x458mm
 DOUBLE WALLS PODWÓJNE ŚCIANY
 BALL BEARING ŁOŻYSKA KULKOWE
 NON SLIP ANTYPOŚLIZKI WYKROTKÓW ANTYPÓŚLIZKOWY BLAT
 UNIVERSAL PERFORATION UNIWERSALNA PERFORACJA



14

DRAWER / SZUFLADA 1

1/2" (12.7 mm): 10, 11, 12, 13, 14, 15, 16, 17, 18, 19, 20, 21, 22, 23, 24, 27, 30, 32 mm; CrV; 1/2" (12.7 mm); CrV; 1/2" (12.7 mm); 45T; CrV; 1/2" (12.7 mm); CrV; 1/2" (12.7 mm); 16; 21 mm; CrV

3/8" (9.5 mm): 6, 7, 8, 9, 10, 11, 12, 13, 14, 15, 16, 17, 18, 19, 20, 21, 22 mm; CrV; 3/8" (9.5 mm) x2; CrV; 3/8" (9.5 mm); CrV; 3/8" (9.5 mm); CrV; 3/8" (9.5 mm); CrV

1/4" (6.3 mm): 3.5, 4, 4.5, 5, 5.5, 6, 7, 8, 9, 10, 11, 12, 13, 14 mm; CrV; 1/4" (6.3 mm): E4, E5, E6, E7, E8 CrV; 1/4" (6.3 mm) x2; CrV; 1/4" (6.3 mm); CrV; 1/4" (6.3 mm); 45T; CrV; 1/4" (6.3 mm); CrV; 1/4" (6.3 mm) x 1/4" (6.3 mm); CrV 50BV30; 1/4" (6.3 mm): 3, 4, 6.5, 7, 8.9 mm; 1/4" (6.3 mm): PH0; PH1; PH2; PH3; 1/4" (6.3 mm): PZ0, PZ1, PZ2, PZ3; 1/4" (6.3 mm): T8, T9, T10, T15, T20, T25, T27, T30; 1/4" (6.3 mm): T8, T9, T10, T15, T20, T25, T27, T30; 1/4" (6.3 mm): 3, 4, 5, 6, 7, 8, mm; 1/4" (6.3 mm) S0, S1, S2; 1/4" (6.3 mm): 4, 5.5, 6.5 mm; CrV; 1/4" (6.3 mm): PZ1, PZ2; CrV; 1/4" (6.3 mm): PH1, PH2; CrV; 1/4" (6.3 mm): T8, T10, T15, T20, T25; CrV; 1/4" (6.3 mm): T10, T15, T25, T40; CrV; 1/4" (6.3 mm): 3, 4, 5, 6 mm; CrV

**12 interchangeable trays with tools
 12 wymiennych modułów z narzędziami**



No.	drawers / szuflady	
58550	6	1

DRAWER / SZUFLADA 2

3/8" (9.5 mm): 4, 5, 6, 7, 8, 10, 12 mm (L=30 mm); 4, 5, 6, 7, 8, 10, 12 mm (L=75 mm); AISI S2; 3/8" (9.5 mm): M5, M6, M8, M10, M12 (L=30 mm); M5, M6, M8, M10, M12 (L=75 mm); AISI S2; 1/2" (12.7 mm) x 3/8" (9.5 mm); 3/8" (9.5 mm) x 3/8" (9.5 mm); CrV 6150; 3/8" (9.5 mm): T20, T25, T30, T40, T45, T50, T55 (L=30 mm); T20, T25, T30, T40, T45, T50, T55 (L=75 mm); AISI S2;

1/2" (12.7 mm): 14, 15, 17; 19, 22 mm; CrV; 1/2" (12.7 mm): E18, E20, E24; CrV; 3/8" (9.5 mm): E10, E11, E12, E14, E16; CrV; 1/2" (12.7 mm); CrV; 1/2" (12.7 mm); CrV

6, 7, 8, 9, 10, 11, 12, 13, 14, 15, 16, 17, 18, 19, 20, 21 mm

DRAWER / SZUFLADA 3

5/32" (4 mm); CrV 6150; 5/32" (4 mm); CrV6150; 5/32" (4 mm): 1.0, 1.5, 2.0, 2.5, 3.0, 3.5 mm; CrV6150; 5/32" (4 mm): PH000; PH00; PH0; PH1; CrV6150; 5/32" (4 mm): PZ0, PZ1; CrV6150; 5/32" (4 mm): T4, T5, T6, T7, T8, T9, T10, T15, T20; CrV6150; 5/32" (4 mm): 0.7, 0.9, 1.3, 2.0, 2.5, 3.0, 4.0, mm; CrV6150; 5/32" (4 mm): 2.5, 3.0, 3.5, 4.0, 4.5, 5.0, 5.5 mm; CrV; 2.0, 2.5, 3.0, 4.0, 5.0, 5.5, 6.0, 8.0, 10.0, 12 mm; CrV; T10, T15, T20, T25, T27, T30, T40, T45, T50; CrV

external straight / proste zewnętrzne; internal straight / proste wewnętrzne; external bent / wygięte zewnętrzne; internal bent / wygięte wewnętrzne

Long nose; Long nose

DRAWER / SZUFLADA 4

300g; Ø 28 mm; 12x150, 16x170 mm; 6x100, 2x140 mm; 1.5x150, 3x150, 5x150, 8x150 mm

3x75, 5x100, 6x100, 8x150 mm; CrV; PH0x75, PH1x100, PH2x100, PH3x150 mm; CrV

300 mm; 300 mm; 300 mm; 300 mm

- PL Szafka serwisowa
- GB Roller cabinet
- D Werkstattrollwagen
- RUS Инструментальный кабинет
- CZ Dílenská skříňka
- RO Trusă de scule
- H Görgös szerszámtároló
- E Armario en ruedas

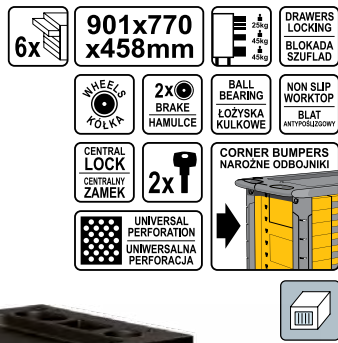

No.	drawers / szuflady	
58539	6	1

- PL Szafka serwisowa
- GB Roller cabinet
- D Werkstattrollwagen
- RUS Инструментальный кабинет
- CZ Dílenská skříňka
- RO Dulap de scule
- H Görgös szerszámtároló
- E Armario en ruedas



No.	drawers / szuflady	
81830	6	1

- PL Szafka serwisowa
- GB Roller cabinet
- D Werkstattrollwagen
- RUS Инструментальный кабинет
- CZ Dílenská skříňka
- RO Trusă de scule
- H Görgös szerszámtároló
- E Armario en ruedas

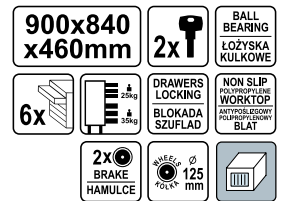

No.	drawers / szuflady	
58561	6	1

- PL Zestaw listew magnetycznych
- GB Magnetic tool holder
- D Magnet Werkzeughalter
- RUS Магнитная рейка
- CZ Magnetický držák nářadí
- RO Suport magnetic
- H Mágneses tartó
- E Bandedeja de accesorios magnética



No.	pcs	
57830	3	6/12

- PL Klucz do szafek serwisowych
- GB Service utility key
- D Schaltschrank-Schlüssel für Gängige Schränke
- RUS Ключ для сервисных шкафов
- CZ Klíč na rozvodné skříňe
- RO Cheie universală pt. panoul de comandă
- H Kapcsolószekrény kulcs
- E Llaves para armarios de control

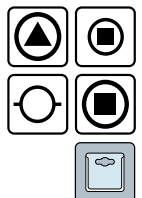

No.		
78477		12/72

PL Wózek narzędziowy
GB Trolley tool box
D Werkzeugtrolley
RUS Мешок для инструментов

CZ Vozík na nářadí
RO Troler pt. scule
H Kerekes szerszámosláda
E Carro de herramientas

46x26x
62.5/83
cm

2
SEGMENTS
SEGMENTOWY

PP ABS



EXTERNAL / ZEWNĘTRZNY
45x25x29.5 cm
INTERNAL / WEWNĘTRZNY
41x21x23 cm

EXTERNAL / ZEWNĘTRZNY
46x26x33.5 cm
INTERNAL / WEWNĘTRZNY
41x21x32 cm



No.
78731



PL Wózek narzędziowy z wyciwanym organizerem
GB Trolley tool box
D Werkzeugtrolley mit abnehmbarem Organizaufsatz
RUS Мешок для инструментов с вынимаемым организером
CZ Vozík na nářadí s odnímatelným organizérem
RO Troler pt. scule
H Kerekes szerszámosláda kivehető szervezővel
E Carro de herramientas con organizador extraíble

46x22
x82/84
cm

PP



33.5x19x20 cm

33.5x21.5x7.5 cm

33.5x19x20 cm



No.
78734



14

PL Wózek narzędziowy 3-segmentowy
GB Trolley tool box 3 segments
D Werkzeugtrolley 3-Teilig
RUS Мешок для инструментов 3 секции
CZ Vozík na nářadí 3 segmenty
RO Troler pt. scule 3 segmente
H Kerekes szerszámosláda 3 részes
E Carro de herramientas 3 compartimentos

45x28
x82/104
cm

3
SEGMENTS
SEGMENTOWY

PP ABS



EXTERNAL / ZEWNĘTRZNY
46x27x29 cm
INTERNAL / WEWNĘTRZNY
43x24x23 cm

35x20x4 cm

EXTERNAL / ZEWNĘTRZNY
45x28.5x34 cm
INTERNAL / WEWNĘTRZNY
39.5x22x29 cm



No.
78736



PL Wózek narzędziowy 3-segmentowy
GB Trolley tool box 3 segments
D Werkzeugtrolley 3-Teilig
RUS Мешок для инструментов 3 секции
CZ Vozík na nářadí 3 segmenty
RO Troler pt. scule 3 segmente
H Kerekes szerszámosláda 3 részes
E Carro de herramientas 3 compartimentos

57x37
x84.5
cm

3
SEGMENTS
SEGMENTOWY

54-98cm

ABS STEEL STAL



EXTERNAL / ZEWNĘTRZNY
54x29.5x21.5 cm
INTERNAL / WEWNĘTRZNY
49x26x13 cm

EXTERNAL / ZEWNĘTRZNY
54x27x26 cm
INTERNAL / WEWNĘTRZNY
40x20.5x9 cm

EXTERNAL / ZEWNĘTRZNY
54x35x39 cm
INTERNAL / WEWNĘTRZNY
50x25x33 cm



No.
78738



PL Smarownica
GB Lever grease gun
D Handhebel Fettpresse
RUS Ручной смазочный шприц

CZ Maznice na šmír
RO Pistol de gresat-vaselina
H Sírzó /tömlővel/
E Engrasador



No.	cm ³	Box
78040	400	10

PL Smarownica
GB Lever grease gun
D Handhebel Fettpresse
RUS Ручной смазочный шприц

CZ Maznice na šmír
RO Pistol de gresat-vaselina
H Sírzó /tömlővel/
E Engrasador

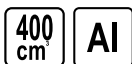

No.	cm ³	Box
78041	400	5/10

PL Towotnica
GB Lever grease gun
D Handhebel Fettpresse
RUS Ручной смазочный шприц

CZ Maznice na šmír
RO Pistol de gresat-vaselina
H Sírzó /tömlővel/
E Engrasador



No.	cm ³	Box
78047	500	10

PL Smarownica
GB Lever grease gun
D Handhebel Fettpresse
RUS Ручной смазочный шприц

CZ Maznice na šmír
RO Pistol de gresat-vaselina
H Sírzó /tömlővel/
E Engrasador



No.	cm ³	Box
78043	600	6/12

PL Smarownica
GB Lever grease gun
D Handhebel Fettpresse
RUS Ручной смазочный шприц

CZ Maznice na šmír
RO Pistol de gresat-vaselina
H Sírzó /tömlővel/
E Engrasador



No.	cm ³	Box
78046	400	10

PL Smarownica
GB Lever grease gun
D Handhebel Fettpresse
RUS Ручной смазочный шприц

CZ Maznice na šmír
RO Pistol de gresat-vaselina
H Sírzó /tömlővel/
E Engrasador

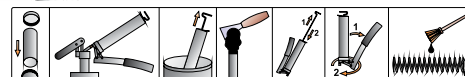
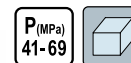

No.	cm ³	Box
78042	400	5/10

PL Towotnica
GB Lever grease gun
D Hand-fettpresse
RUS Ручной смазочный шприц

CZ Maznice na šmír
RO Pistol de gresat cu tija rigida
H Sírzó /tömlővel/
E Engrasador



No.	cm ³	Box
78050	445	15

PL Weżyk do towotnicy
GB Flexible tube for grease gun
D Schlauch für Fettpresse
RUS Шланг для шприца

CZ Hadička na maznice na šmír
RO Furtun flexibil pt. pistol de gresat
H Tömlő a zsíróhoz
E Manguera para engrasador



No.	L (mm)	Box
78045	240	50/250

- PL Zestaw końcówek czterozłączkowych do smarownic
 GB Heavy duty jaw couplers
 D Mundstücksatz für Handhebel Fettpressen
 RUS Соединительные патроны для масляного пистолета
 CZ Sada koncovek k mazacímu lisu
 RO Doza de legatura
 H Tömlő csatlakozó karos zsírzóhoz
 E Juego de boquillas para engrasadores



No.	Ø (mm)	pcs	
78061	15	4	20/80

- PL Pompa ręczna do oleju
 GB Manual oil pump
 D Öl-Umfüllpumpe
 RUS Ручной насос для перекачки масел
- CZ Pompa ruční na olej
 RO Pompa manuala apa ulei
 H Kézi olajszivattyú
 E Bomba manual para aceite



No.	l / min	
78000	19	5

- PL Pompa ręczna do oleju
 GB Manual oil pump
 D Öl-Umfüllpumpe
 RUS Ручной насос для перекачки масел
- CZ Pompa ruční na olej
 RO Pompa manuala apa ulei
 H Kézi olajszivattyú
 E Bomba manual para aceite

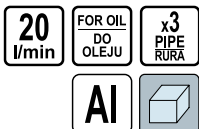

No.	l / min	
78002	20	10

- PL Samozasysający wąż do paliwa
 GB Self-priming fuel pump
 D Selbstansaugender Kraftstoffschlauch
 RUS Шланг с обратным клапаном для перекачки масла/топлива
 CZ Přečerpávací hadice se samonasávacím ventilem
 RO Furtun pt. transfer lichide
 H Üzemanyag légtelenítő kézi pumpa
 E Manguera aspiración manual



No.		
83009		6/24

- PL Wężyk giętki do smarownic
 GB Flexible hose for grease gun
 D Schlauch für Fettpresse
 RUS Гибкий шланг для товогнницы
 CZ Hadička na maznice na šmir
 RO Furtun flexibil pt. pistol de gresat
 H Tömlő a zsírzóhoz
 E Manguera para engrasador



No.	L (mm)	Mpa	
78067	300	31	50/250
78068	500	31	50/250

- PL Pompa ręczna do oleju
 GB Manual oil pump
 D Öl-Umfüllpumpe
 RUS Ручной насос для перекачки масел
- CZ Pompa ruční na olej
 RO Pompa manuala apa ulei
 H Kézi olajszivattyú
 E Bomba manual para aceite

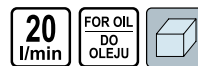

No.	l / min	
78001	20	8

- PL Mini pompa ręczna do oleju
 GB Manual oil pump
 D Öl-Umfüllpumpe
 RUS Ручной насос для перекачки масел
- CZ Pompa ruční na olej
 RO Pompa manuala apa ulei
 H Kézi olajszivattyú
 E Bomba manual para aceite

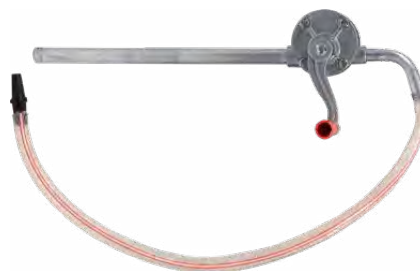

No.	l / min	
78003	15	20

- PL Elektryczna pompa do oleju
 GB Oil extractor
 D Ölabsaugpumpe
 RUS Насос перекачки масла
- CZ Čerpadlo na odsávání oleje
 RO Olajleszívó szivattyú
 H Pompa electrica pt. extras ulei
 E Bomba extractora de aceite eléctrica para coche

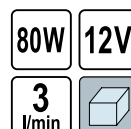

No.	W	
78007	80	10

PL Odsysarka ręczna do oleju
 GB Oil drainer
 D Öl-Absaugpumpe
 RUS Ручной шприц для откачки масла

CZ Ruční odsávačka oleje
 RO Pompa de ulei
 H Kézi olajszivattyú
 E Bomba de succión manual para aceite



VOREL

No.	cm ³	
78030	200	10

PL Odsysarka ręczna do oleju
 GB Oil drainer
 D Öl-Absaugpumpe
 RUS Ручной шприц для откачки масла

CZ Ruční odsávačka oleje
 RO Pompa de ulei
 H Kézi olajszivattyú
 E Bomba de succión manual para aceite

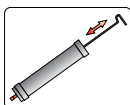

VOREL

No.	cm ³	
78044	500	10/20

PL Oliwiarka
 GB Oil can
 D Ölkanne
 RUS Масленка



No.	ml	
78300	300	15/60

PL Oliwiarka z końcówką sztywną
 GB Oil can with rigid spout
 D Ölkanne mit starrem Aufsatz
 RUS Масленка с твердым наконечником

CZ Olejová maznice
 RO Cana ulei cu furtun rigid
 H Olajozó kanna, merev szárral
 E Aceitera



VOREL

No.	ml	
78303	300	10/60

PL Odsysarka ręczna do oleju
 GB Oil drainer
 D Öl-Absaugpumpe
 RUS Ручной шприц для откачки масла

CZ Ruční odsávačka oleje
 RO Pompa de ulei
 H Kézi olajszivattyú
 E Bomba de succión manual para aceite



VOREL

No.	cm ³	
78031	400	10

PL Pompa ręczna do oleju
 GB Manual oil pump
 D Öl-Umfüllpumpe
 RUS Ручной насос для перекачки масел

CZ Pompa ruční na olej
 RO Pompa manuala apa ulei
 H Kézi olajszivattyú
 E Bomba manual para aceite



VOREL

No.	cm ³	
78035	500	10

PL Oliwiarka z wężykiem
 GB Oil can with flexible hose
 D Ölkanne mit flexiblem Aufsatz
 RUS Масленка с гибким шлангом

CZ Olejova maznice
 RO Cana ulei cu furtun flexibil
 H Olajozó kanna, hajlékony tömlővel
 E Aceitera



VOREL

No.	ml	
78306	200	10/60

PL Klucz do filtra oleju
 GB Oil filter wrench
 D Ölfilterspinne
 RUS Съёмник масляных фильтров

CZ Klíč na filtr oleju
 RO Cheie pt. filtru de ulei
 H Olajszűrő kulcs
 E Llave de filtro



VOREL

No.	size / rozmiar	Ø (mm)	
57600	3/8" (10.0 mm)	65-110	6/36

PL Klucz do filtra oleju, zaciskowy
 GB Oil filter wrench
 D Ölfilterschlüssel
 RUS Съёмник масляных фильтров замковый

CZ Klíč na filtr oleju svěrácí
 RO Cheie cu strângere pt. filtru de ulei
 H Olajszűrő kulcs, pattintos
 E Llave de filtro de apriete



No.	Ø (mm)	
57610	55-110	10/50

PL Klucz do filtra oleju
 GB Oil filter wrench
 D Ölfilterspinne
 RUS Съёмник масляных фильтров

CZ Klíč na filtr oleju
 RO Cheie pt. filtru de ulei
 H Olajszűrő kulcs
 E Llave de filtro



No.	
57630	10/40

PL Klucz do filtra oleju
 GB Oil filter wrench
 D Ölfilterschlüssel
 RUS Ключ к масляному фильтру

CZ Klíč na filtr oleju
 RO Cheie pt. filtru de ulei
 H Olajszűrő kulcs
 E Llave para el filtro de aceite



No.	Ø (mm)	
57649	55-75	10/50
57650	75-95	10/50
57651	95-115	10/50

PL Ściągacz do łożysk
 GB Gear puller
 D Dreiarmeriger Abzieher
 RUS Съёмник подшипников 3-х лапчатый

CZ Stahováč na ložiska
 RO Clește cu 3 brațe pt. extras rulmenți
 H Hidraulikus csapágyelhúzó
 E Extractor de cojinetes

No.	mm	arms / ramiona	
80500	75	3	4/40
80510	100	3	5/30
80520	150	3	2/20
80530	200	3	2/12

PL Klucz do filtra oleju
 GB Oil filter wrench
 D Ölfilterspinne
 RUS Съёмник масляных фильтров

CZ Klíč na filtr oleju
 RO Cheie pt. filtru de ulei
 H Olajszűrő kulcs
 E Llave de filtro



No.	
57620	10/100

PL Klucz do filtra oleju
 GB Oil filter wrench
 D Ölfilterspinne
 RUS Съёмник масляных фильтров

CZ Klíč na filtr oleju
 RO Cheie pt. filtru de ulei
 H Olajszűrő kulcs
 E Llave de filtro



No.	
57640	25/100

PL Klucz do filtra oleju
 GB Oil filter wrench
 D Ölfilterschlüssel
 RUS Ключ к масляному фильтру

CZ Klíč na filtr oleju
 RO Cheie pt. filtru de ulei
 H Olajszűrő kulcs
 E Llave para el filtro de aceite



No.	Ø (mm)	
57612	73-85	12/48
57613	83-95	12/48
57614	93-111	12/48



PL Ściągacz do łożysk
GB Gear puller
D Dreiarmliger Abzieher
RUS Съёмник подшипников 3-х лапчатый

CZ Stahovák na ložiska
RO Clește cu 3 brațe pt. extras rulmenți
H Hidraulikus csapágyelhúzó
E Extractor de cojinetes



No.	mm	∅ (mm)	arms / ramiona	∅
80470	75	14	2	30
80471	100	17	2	24
80472	130	17	2	20
80473	150	19	2	12
80474	200	22	2	6

PL Ściągacz do sprężyn
GB Coil spring clamp
D Federspanner
RUS Стяжка пружин

CZ Stahovák na pružiny
RO Dispozitiv pt. demontat arcuiri auto
H Rugóelhúzó
E Extractor de muelles



No.	pcs	∅
80600	2	6/12

PL Ściągacz do sprężyn
GB Coil spring clamp
D Federspanner
RUS Стяжка пружин

CZ Stahovák na pružiny
RO Dispozitiv pt. demontat arcuiri auto
H Rugóelhúzó
E Extractor de muelles



No.	pcs	∅
80601	2	10

PL Ściągacz do sworzni kulistych
GB Tie rod end lifter
D Universal-Kugelgelenk-Abzieher
RUS Съёмник шаровых опор

CZ Stahovák kulových čepů řízení
RO Extractor pt. articulatii sferice
H Gömbfej kinyomó
E Extractor pt. articulatii sferice



No.	∅
80640	25

PL Ściągacz do uszcozelek
GB Seal puller
D Dichtungs- Abzieherwerkzeug
RUS Съёмник прокладок

CZ Škrabka na těsnění
RO Ancoră pt. garnituri
H Tömítéslehúzó
E Tensor para juntas

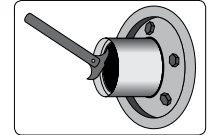

No.	L (mm)	∅
80701	325	6/36

PL Zestaw wkrętków precyzyjnych i haczyków
GB Precision screwdriver set
D Präzisions-Feinmechanikersatz
RUS Набор отвёрток для точных работ

CZ Šroubováký sada
RO Set surubelnite
H Órás csavarhúzó készlet
E Destornilladores precisos

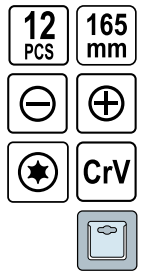

- 2.5 mm, 3.5 mm
- PH00, PH0
- T6, T7, T8, T10 45°, 90°, 135°, 180°



No.	pcs	∅
64555	12	10/40

PL Ściągacz do sworzni kulistych
GB Tie rod end lifter
D Universal-Kugelgelenk-Abzieher
RUS Съёмник шаровых опор

CZ Stahovák kulových čepů řízení
RO Extractor pt. articulatii sferice
H Gömbfej kinyomó
E Extractor pt. articulatii sferice



No.	∅
80620	25/50

PL Krzyżakowy klucz do kół
GB Cross rim wrench
D Kreuzschlüssel
RUS Балонный ключ-крест

CZ Klíč na kola křížový
RO Cheie în cruce pt. roți
H Kereszt kerékkulcs
E Llave cruz para ruedas



No.	mm / inch (cale)	∅
57000	17x19x22x13/16" (20.6 mm)	20

PL Krzyżakowy klucz do kół
GB Cross rim wrench
D Kreuzschlüssel
RUS Балонный ключ-крест

CZ Klíč na kola křížový
RO Cheie în cruce pt. roți
H Kereszt kerékkulcs
E Llave cruz para ruedas



No.	mm	
57010	17x19x21x23	20

PL Krzyżakowy klucz do kół
GB Cross rim wrench
D Kreuzschlüssel
RUS Балонный ключ-крест

CZ Klíč na kola křížový
RO Cheie în cruce pt. roți
H Kereszt kerékkulcs
E Llave cruz para ruedas



No.	mm	
57030	17x19x21x23	20

PL Klucz do kół rozsuwany
GB L-type wheel wrench
D Radschlüssel
RUS Ключ баллонный телескопический L-типа

CZ Klíč na kola rozvírány
RO Cheie pt. roți extensibilă
H Kerékkulcs, kihúzható
E Llave para ruedas extensible

360-510 mm
17-19 mm

1/2"
12.5mm



No.	mm	L (mm)	size / rozmiar	
57100	17/19	360-510	1/2" (12.5 mm)	10/20

PL Klucz do świec
GB Spark plug wrench
D Zündkerzenschlüssel
RUS Ключ свечной

CZ Svičkový klíč
RO Cheie pt. bujii
H Gyertyakulcs
E Llave para bujias



No.	mm	L (mm)	
57160	16	150	25/50
57210	21	150	25/50

PL Krzyżakowy klucz do kół
GB Cross rim wrench
D Kreuzschlüssel
RUS Балонный ключ-крест

CZ Klíč na kola křížový
RO Cheie în cruce pt. roți
H Kereszt kerékkulcs
E Llave cruz para ruedas



No.	mm / inch (cale)	
57020	17x19x21x1/2" (12.7 mm)	10

PL Krzyżakowy klucz do kół
GB Cross rim wrench
D Kreuzschlüssel
RUS Балонный ключ-крест

CZ Klíč na kola křížový
RO Cheie în cruce pt. roți
H Kereszt kerékkulcs
E Llave cruz para ruedas



No.	mm / inch (cale)	
57050	24x27x32x3/4" (19.0 mm)	5

PL Zaciskacz do pierścieni
GB Piston ring compressor
D Kolbenring-Spannband
RUS Зажим колец
CZ Svěrka na kroužky
RO Clește pt. strâns inele
H Gyűrűbepattintó
E Pinza para anillos

AISI #304

65 Mn



No.	Ø (mm)	H (mm)	
80660	50-125	75	36
80661	75-175	100	36

PL Klucz do świec
GB Spark plug wrench
D Zündkerzenschlüssel
RUS Ключ свечной

CZ Svičkový klíč
RO Cheie pt. bujii
H Gyertyakulcs
E Llave para bujias



No.	mm	L (mm)	
57260	16/21	150	25/50

- PL Klucz do świec CZ Svičkový klíč
 GB Spark plug wrench RO Cheie pt. bujii
 D Zündkerzenschlüssel H Gyertyakulcs
 RUS Ключ свечной E Llave para bujias

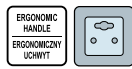

No.	mm	L (mm)	Box
57220	16	260	20/40
57221	21	260	20/40

- PL Tester grubości lakieru CZ Tester tloušťky laku
 GB Paint thickness tester RO Tester de buzunar grosime vopsea
 D Lackdickenmessgerät H Rétegvastagság mérő
 RUS Толщиномер лакокрасочного покрытия E Medidor de espesor de recubrimiento

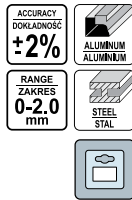

No.	Box
81731	40/80

- PL Samochodowy próbnik napięcia CZ Automobilový zkoušeč napětí
 GB Car voltage tester RO Creion de tensiune pt. automobile
 D Autospannungstester H Autós fáziskereső
 RUS Пробник автомобильный E Comprobador de corriente de coche



No.	V	Box
65270	6-24	20/200

- PL Łapka magnetyczna, giętka GB Flexible pick-up handle, magnetic
 D Magnetisch flexibler Greifer
 RUS Гибкий магнитный захват
 CZ Vytahovák magnetický ohebný
 RO Surubelnita flexibilă magnetică
 H Mágneses felszedő eszköz, hajlékony nyél
 E Grifo magnético flexible



No.	L (mm)	Box
78401	530	50/100

- PL Klucze do przewodów hamulcowych CZ Klíče na vedení brzd
 GB Flare nut wrenches RO Cheie pt. conducte de frână
 D Bremsleitungschlüsselsatz H Fékcsőkulcs
 RUS Набор ключей разрезных E Llaves para tubería de frenado

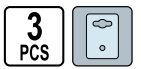

No.	pcs	Box
57700	3	12/60

- PL Samochodowy próbnik napięcia CZ Automobilový zkoušeč napětí
 GB Car voltage tester RO Creion de tensiune pt. automobile
 D Autospannungstester H Autós fáziskereső
 RUS Пробник автомобильный E Comprobador de corriente de coche



No.	V	Box
65260	6-24	20/200

- PL Łapka do podnoszenia CZ Patka pro zdvihání
 GB Pick-up tool RO Surubelnita flexibilă
 D Starer Greifer H Emelőlapka
 RUS Гибкий захват „Pick-up” E Grifo para recoger pick up



No.	L (mm)	Box
78400	600	50/150

- PL Chwytnak teleskopowy LED GB LED magnetic pick up tool
 D LED Magnet Heber
 RUS Захват магнитный телескопический с подсветкой
 CZ Patka magnetická teleskopická LED
 RO Telescop magnetic cu LED
 H LED felszedő mágnes teleszkópos nyéllel
 E Herramienta para levantar, telescópica, con LED



No.	LED	battery / bateria	Box
78405	3	4xLR44	12/48



PL Taboret warsztatowy z szufladą
GB Workshop seat with drawer
D Werkstattthocker mit Schublade
RUS Табурет рабочий с ящиком

CZ Dílný taburet se zásuvkou
RO Taburet atelier cu sertar
H Műhely zsámoly fiókkal
E Taburete de taller con cajón



No.	max (kg)	
81824	90	4

PL Leżanka warsztatowa na kółkach
GB Workshop creeper
D Werkstattliegewagen auf Rädern
RUS Лежак ремонтный

CZ Lehátko montážní na kolečkách
RO Targa auto mobila
H Fekpad gurulos
E Camilla de taller con ruedas



No.	mm	
81820	930x440x105	1

PL Elektryczny klucz udarowy
GB Electric impact wrench
D Elektro-Schlagschrauber
RUS Электрический гайковерт
CZ Elektrický rázový uťahovák
RO Cheie electrică
H Elektromos ütvecsavarozó
E llave de impacto eléctrica



$L_{pA} = 89,0 \pm 3,0$ dB; $L_{wA} = 100,0 \pm 3,0$ dB; $a_n = 10,04 \pm 1,5$ m/s²

No.	W	min-1	
57092	1100	2200	2

PL Taboret warsztatowy teleskopowy
GB Pneumatic car seat
D Werkstattthocker, teleskopisch
RUS Табурет рабочий подъемный

CZ Dílný taburet teleskopický
RO Taburet atelier telescopic
H Teleszkópos műhely zsámoly
E Taburete de taller telescópico



No.	max (kg)	
81825	135	4

PL Elektryczny klucz udarowy
GB Electric impact wrench
D Elektro-Schlagschrauber
RUS Электрический гайковерт
CZ Elektrický rázový uťahovák
RO Cheie electrică
H Elektromos ütvecsavarozó
E llave de impacto eléctrica



$L_{pA} = 87,5 \pm 3,0$ dB;
 $L_{wA} = 98,5 \pm 3,0$ dB;
 $a_n = 9,93 \pm 1,5$ m/s²



No.	W	min-1	
57091	800	2200	5

PL Elektryczny klucz udarowy
GB Electric impact wrench
D Elektro-Schlagschrauber
RUS Электрический гайковерт
CZ Elektrický rázový uťahovák
RO Cheie electrică
H Elektromos ütvecsavarozó
E llave de impacto eléctrica

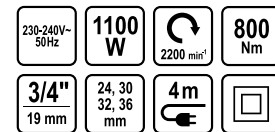

$L_{pA} = 89,0 \pm 3,0$ dB; $L_{wA} = 100,0 \pm 3,0$ dB; $a_n = 10,04 \pm 1,5$ m/s²

No.	W	min-1	
57097	1100	2200	2

- PL Diodowa lampa bezprzewodowa
- GB Rechargeable work lamp
- D Led Werkstattlampe
- RUS Светодиодная беспроводная лампа
- CZ Montážní lampa diodová bezpřívodová
- RO Lampa cu led fara cablu
- H Ledlampa
- E Lámpara inalámbrica de diodos

SMD LED

12 LED	200 lm	CHARGING TIME CZAS ŁADOWANIA 4 h	WORK TIME CZAS PRACY 4.5 h
12 V 2000mAh Li-Ion	230V~50Hz BATTERY CHARGER ŁADOWARKA	12 V BATTERY CHARGER ŁADOWARKA	HOOK HAK
		MAGNETIC	



A++
A+
A

VOREL

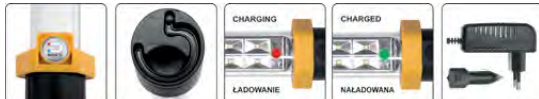

No.	LED	mAh	
82728*	12	2000	20

- PL Diodowa lampa bezprzewodowa
- GB Rechargeable work lamp
- D Led Werkstattlampe
- RUS Светодиодная беспроводная лампа
- CZ Montážní lampa diodová bezpřívodová
- RO Lampa cu led fara cablu
- H Ledlampa
- E Lámpara inalámbrica de diodos

3W	200 lm	3.7 V 2000mAh Li-Ion	12V BATTERY CHARGER ŁADOWARKA	FRONT LIGHTING FUNKCJA UKŁADU
230V~50Hz BATTERY CHARGER ŁADOWARKA	MAGNETIC	WORK TIME CZAS PRACY 4 h	CHARGING TIME CZAS ŁADOWANIA 4 h	HOOK HAK



A++
A+
A

VOREL



No.	W	mAh	
82719*	3	2000	20

- PL Lampa robocza LED
- GB LED work light
- D LED Handleuchte
- RUS Светодиодный светильник для мастерской
- CZ Ruční svítidla LED
- RO Lampa portabila cu LED
- H LED lámpa
- E Lámpara de taller LED

3W	100 lm	2 LIGHTING MODES TRYBY ŚWIĘCENIA	WORK TIME CZAS PRACY 4 h
3.7V 800mAh Li-Ion	Micro USB	MAGNETIC	HOOK HAK



A++
A+
A

COB LED



VOREL

2 tryby świecenia: 100%, 50%
przytrzymanie przycisku: światło czerwone, pulsowanie, sos

No.	W	lumens	h	
82723*	3	100	4	12/48

- PL Diodowa lampa bezprzewodowa
- GB Rechargeable work lamp
- D Led Werkstattlampe
- RUS Светодиодная беспроводная лампа
- CZ Montážní lampa diodová bezpřívodová
- RO Lampa cu led fara cablu
- H Ledlampa
- E Lámpara inalámbrica de diodos

30 LED	120 lm	6000K	IP20	12V BATTERY CHARGER ŁADOWARKA	230V~50Hz BATTERY CHARGER ŁADOWARKA
3.7V 1200mAh Li-Ion	CHARGING TIME CZAS ŁADOWANIA 4.5 h	WORK TIME CZAS PRACY 3 h	HOOK HAK	MAGNETIC	



A++
A+
A

VOREL

SMD LED

No.	LED	mAh	
82729*	30	1200	6/12

- PL Diodowa lampa bezprzewodowa
- GB Rechargeable work lamp
- D Led Werkstattlampe
- RUS Светодиодная беспроводная лампа
- CZ Montážní lampa diodová bezpřívodová
- RO Lampa cu led fara cablu
- H Ledlampa
- E Lámpara inalámbrica de diodos

36 LED	3.7V 1200mAh Li-Ion	230V~50Hz BATTERY CHARGER ŁADOWARKA	12V BATTERY CHARGER ŁADOWARKA
4 h	4 h	MAGNETIC	HOOK HAK



A++
A+
A

VOREL

LED

No.	LED	mAh	
82720*	36	500	10/20

- PL Lampa robocza LED
- GB LED work light
- D LED Werkstattlampe
- RUS Светодиодный светильник для мастерской
- CZ Ruční svítidla LED
- RO Lampa portabila cu LED
- H LED lámpa
- E Lámpara de taller LED

230V~50Hz	280 lm	16 LED
HOOK HAK	3.2 W	5.0m



A++
A+
A

VOREL

SMD LED

No.	W	LED	
82699*	3.2	16	10/20

PL Lampa robocza LED
GB LED work light
D LED Werkstattlampe
RUS Светодиодный светильник для мастерской
CZ Ruční svítidla LED
RO Lampa portabila cu LED
H LED lámpa
E Lámpara de taller LED

230V~
50Hz

400
lm

24
LED

HOOK
HAK

4.5
W

5.0m



SMD
LED

VOREL

No.	W	LED	☐
82706*	4.5	24	10/20

PL Lampa warsztatowa
GB Work light
D Werkstattlampe
RUS Лампа-переноска

CZ Pracovní lampa
RO Lampă pt. atelier
H Szerelőlámpa
E Lámpara de taller

230V~
50Hz

E 27

60W

5.0m



No.	W	type	☐
82715*	60	„PLASTIC“	10

PL Lampa warsztatowa
GB Work light
D Werkstattlampe
RUS Лампа-переноска

CZ Pracovní lampa
RO Lampă pt. atelier
H Szerelőlámpa
E Lámpara de taller

230V~
50Hz

E 27

5.0m



No.	W	type	☐
82716*	60	„GUMMI“	10
82717*	100	„GUMMI“	10

PL Lampa warsztatowa
GB Work light
D Werkstattlampe
RUS Лампа-переноска

CZ Pracovní lampa
RO Lampă pt. atelier
H Szerelőlámpa
E Lámpara de taller

230V~
50Hz

E 27

100
W

5.0m



No.	W	type	☐
82713*	100	„PRACTIC“	10

PL Lampa warsztatowa
GB Work light
D Werkstattlampe
RUS Лампа-переноска

CZ Pracovní lampa
RO Lampă pt. atelier
H Szerelőlámpa
E Lámpara de taller

230V~
50Hz

E 27

60W

5.0m



No.	W	type	☐
82714*	60	„CLASSIC“	10

PL Lampa robocza LED
GB LED work light
D LED Handluuchte
RUS Светодиодный светильник для мастерской
CZ Ruční svítidla LED
RO Lampa portabila cu LED
H LED lámpa
E Lámpara de taller LED



COB
LED



VOREL

No.	battery / bateria	☐
82724	3xAAA	12/48

- PL Lampa robocza LED
- GB LED work light
- D LED Handleuchte
- RUS Светодиодный светильник для мастерской
- CZ Ruční svítidla LED
- RO Lampa portabilă cu LED
- H LED lámpa
- E Lámpara de taller LED

COB
LED

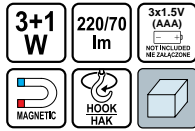

VOREL

No.	LED	battery / bateria	
82733	3xAAA	24/48	

- PL Lampa robocza LED
- GB LED work light
- D LED Handleuchte
- RUS Светодиодный светильник для мастерской
- CZ Ruční svítidla LED
- RO Lampa portabilă cu LED
- H LED lámpa
- E Lámpara de taller LED

SMD
LED

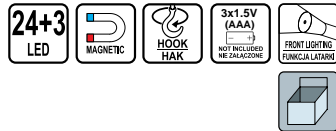

VOREL

No.	LED	battery / bateria	
82731	24+3	3xAAA	12/48

- PL Lampa robocza LED
- GB LED work light
- D LED Handleuchte
- RUS Светодиодный светильник для мастерской
- CZ Ruční svítidla LED
- RO Lampa portabilă cu LED
- H LED lámpa
- E Lámpara de taller LED

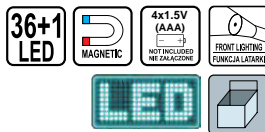

VOREL

No.	LED	battery / bateria	
82735	36+1	4xAAA	12/48

- PL Lampa robocza LED
- GB LED work light
- D LED Handleuchte
- RUS Светодиодный светильник для мастерской
- CZ Ruční svítidla LED
- RO Lampa portabilă cu LED
- H LED lámpa
- E Lámpara de taller LED

SMD
LED

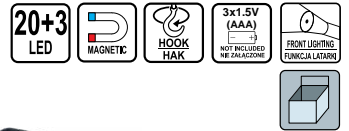

VOREL

No.	LED	battery / bateria	
82730	20+3	3xAAA	12/48

- PL Lampa robocza LED
- GB LED work light
- D LED Handleuchte
- RUS Светодиодный светильник для мастерской
- CZ Ruční svítidla LED
- RO Lampa portabilă cu LED
- H LED lámpa
- E Lámpara de taller LED

COB
LED



VOREL

No.	battery / bateria	
82726	3xAA	12/48

- PL Lampa robocza LED
- GB LED work light
- D LED Handleuchte
- RUS Светодиодный светильник для мастерской

- CZ Ruční svítidla LED
- RO Lampa portabilă cu LED
- H LED lámpa
- E Lámpara de taller LED

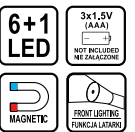

VOREL

SMD
LED

No.	LED	battery / bateria	
82742	6+1	3xAAA	12/48

- PL Zestaw latarka UV LED i okulary
 GB UV LED flashlight and glasses set
 D UV LED-Taschenlampe mit UV Schutzbrille
 RUS Комплект для проверки утечек хладогента - УФ фонарь 21-LED
- CZ UV LED svítilna + brýle
 RO Set lanterna UV LED si ochelari
 H UV LED zseblampa + szemüveg
 E UV LED linterna con gafas para



21 LED
UV
395 nm
 3x1.5V (AAA)
 NOT INCLUDED
 NE ZALAZCONE



No.	LED	battery / bateria	
82756	21	3xAAA	80

- PL Latarka LED
 GB LED Flashlight
 D LED-Taschenlampe
 RUS Светодиодный фонарь
- CZ LED svítilna
 RO Lanterna cu LED
 H LED elemlámpa
 E Linterna LED



5W
280 lm
 ZOOM
 3x1.5V (AAA)
 NOT INCLUDED
 NE ZALAZCONE



No.	battery / bateria	
88555	3xAAA	12/48

- PL Diodowa lampa warsztatowa akumulatorowa
 GB Workshop LED battery lamp
 D LED Akku-handleuchte
 RUS Светодиодная беспроводная лампа
 CZ Ruční svítilna LED
 RO Lampa portabila cu acumulator leduri
 H LED szerelő lámpák
 E Linterna LED recargable



3W
100 lm
10.8V 1300mAh Li-Ion
 100-240V~
 50-60Hz
 BATTERY CHARGER
 ŁADOWNIKA
 BATTERY FOR:
 AKUMULATOR
 GLA:
78981



No.	V	W	
78118*	10.8	3	8

- PL Latarka LED
 GB LED Flashlight
 D LED-Taschenlampe
 RUS Светодиодный фонарь
- CZ LED svítilna
 RO Lanterna cu LED
 H LED elemlámpa
 E Linterna LED



10W
500 lm
 XM-L2
 3x1.5V (AA)
 NOT INCLUDED
 NE ZALAZCONE



No.	battery / bateria	
88560	3xAA	12/24

- PL Latarka LED
 GB LED Flashlight
 D LED-Taschenlampe
 RUS Светодиодный фонарь
- CZ LED svítilna
 RO Lanterna cu LED
 H LED elemlámpa
 E Linterna LED



3W
150 lm
 ZOOM
 3x1.5V (AAA)
 NOT INCLUDED
 NE ZALAZCONE



No.	W	lumens	battery / bateria	
88550	3	150	3xAAA	12/48

- PL Podnośnik hydrauliczny słupkowy
 GB Hydraulic bottle jack
 D Hydraulischen Wagenheber
 RUS Домкрат гидравлический „Бутылочный”
- CZ Pistový zvedák hydraulický
 RO Cric hidraulic cu piston
 H Hidraulikus emelő
 E Gato de embolo hid.



No.	max t	↑ mm	
80012	2	148-276	6
80022	3	180-350	6
80032	5	185-355	4
80042	8	190-365	4
80052	10	195-375	4
80062	12	200-380	3
80072	15	205-390	2
80082	20	217-402	2

PL Dźwignik tłokowy hydrauliczny
GB Hydraulic floor jack
D Hydraulischer Rangierwagenheber
RUS Домкрат гидравлический подкатной

CZ Pistový zvedák hydraulický – pracovní
RO Cric hidraulic cu piston pt. atelier
H Hidraulikus emelő – szervíz
E Gato de embolo hidr.rana



No.	max t	↑ mm	
80111	2	135-325	1

PL Dźwignik tłokowy hydrauliczny
GB Hydraulic floor jack
D Hydraulischer Rangierwagenheber
RUS Домкрат гидравлический подкатной

CZ Pistový zvedák hydraulický – pracovní
RO Cric hidraulic cu piston pt. atelier
H Hidraulikus emelő – szervíz
E Gato de embolo hidr.rana



No.	max t	↑ mm	
80120	2	130-350	1

PL Podnośnik mechaniczny trapezowy
GB Scissors jack
D Trapezwagenheber
RUS Домкрат механический ромбовый

CZ Lichoběžníkový zvedák
RO Cric mecanic
H Trapézemelő
E Gato mecanico-trapezoidal



No.	t	↑ mm	
80252	1.5	95-390	5

PL Dźwignik tłokowy hydrauliczny
GB Hydraulic floor jack
D Hydraulischer Rangierwagenheber
RUS Домкрат гидравлический подкатной

CZ Pistový zvedák hydraulický – pracovní
RO Cric hidraulic cu piston pt. atelier
H Hidraulikus emelő – szervíz
E Gato de embolo hidr.rana



No.	max t	↑ mm	
80121	2	130-350	1

PL Dźwignik tłokowy hydrauliczny
GB Hydraulic floor jack
D Hydraulischer Rangierwagenheber
RUS Домкрат гидравлический подкатной

CZ Pistový zvedák hydraulický – pracovní
RO Cric hidraulic cu piston pt. atelier
H Hidraulikus emelő – szervíz
E Gato de embolo hidr.rana



No.	max t	↑ mm	
80233	3	150-485	1

PL Podnośnik mechaniczny trapezowy
GB Scissors jack
D Trapezwagenheber
RUS Домкрат механический ромбовый

CZ Lichoběžníkový zvedák
RO Cric mecanic
H Trapézemelő
E Gato mecanico-trapezoidal



No.	t	↑ mm	
80271	1.2	100-350	4

- PL Podstawka pod samochód
- GB Jack stand
- D Unterstellbock
- RUS Подставка для автомобиля
- CZ Podstavec pod auto
- RO Chituc de metal
- H Gépkocsi alátét
- E Apoyos de coche



No.	t	↑ mm	pcs	Box
80300	2	250-380	5	

- PL Podstawka pod samochód
- GB Jack stand
- D Unterstellbock
- RUS Подставка для автомобиля
- CZ Podstavec pod auto
- RO Chituc de metal
- H Gépkocsi alátét
- E Apoyos de coche



VOREL

No.	t	↑ mm	pcs	Box
80312	2	280-370	2	5

- PL Rozpierač hydrauliczny
- GB Porta power repair kit
- D Hydraulischer Richt und Ausbeulsatz
- RUS Гидравлическая распорная стойка в наборе
- CZ Hydraulický rozpěrák
- RO Trusa pompa hidraulica + accesorii
- H Hidraulikus bontó
- E Cilindro de freno



VOREL

No.	t	Box
80412	10	1

- PL Ściągacz blacharski hydrauliczny
- GB Pull - back ram
- D Hydraulische Zugzylindereinheit
- RUS Гидравлическая стяжка-крюк
- CZ Klempířské stahovadlo hydraulické
- RO Carlig hidraulic tractare
- H Hidraulikus lemezkihúzó
- E Extractor de latoneria de fontanero

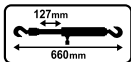

VOREL

No.	t	MPa	Box
80450	10	55	4

- PL Podstawka pod samochód
- GB Jack stand
- D Unterstellbock
- RUS Подставка для автомобиля
- CZ Podstavec pod auto
- RO Chituc de metal
- H Gépkocsi alátét
- E Apoyos de coche



VOREL

No.	t	↑ mm	pcs	Box
80307	2	265-390	2	1
80308	3	275-415	2	1
80309	6	360-585	2	1

- PL Rozpierač hydrauliczny
- GB Porta power repair kit
- D Hydraulischer Richt und Ausbeulsatz
- RUS Гидравлическая распорная стойка в наборе
- CZ Hydraulický rozpěrák
- RO Trusa pompa hidraulica + accesorii
- H Hidraulikus bontó
- E Cilindro de freno



VOREL

No.	t	Box
80402	4	1

- PL Pompa do rozpierača hydraulicznego
- GB Accessories for porta power
- D Druckeinheit für Hydr. Spreizer
- RUS Ручной насос для гидравлической распорной стойки
- CZ Pumpa na hydraulický rozpěrák
- RO Pompa hidraulica
- H Szivattyú hidraulikus bontóhoz
- E Bomba para cilindro de freno



VOREL

No.	t	Box
80320	4	2
80330	10	2

- PL Silownik do rozpierača hydraulicznego
- GB Accessories for porta power
- D Kraftzylinder für Hydr. Spreizer
- RUS Сервомотор для гидравлической распорной стойки
- CZ Servomotor na hydraulický rozpěrák
- RO Accesorii pompa hidraulica
- H Erőátvitel a hidraulikus bontóhoz
- E Servo para cilindro de freno



VOREL

No.	t	Box
80340	4	4
80350	10	4

- PL Prostownik
- GB Rectifier
- D Batterieladegerät
- RUS Зарядное устройство
- CZ Usměrňovač
- RO Redresor
- H Akkumulátortöltő
- E Rectificador

220-240V-50/60Hz	6 V 12 V	1 A 4 A	120 Ah max
WET GEL AGM	MOKRY ZELOWY AGM	MICROPROCESSOR MICROPROCESSOR	



No.	V	A	Ah max	
82555	6 / 12	1 / 4	120	10

- PL Prostownik
- GB Rectifier
- D Batterieladegerät
- RUS Зарядное устройство
- CZ Usměrňovač
- RO Redresor
- H Akkumulátortöltő
- E Rectificador

6 A MAX. PRĄD ŁADOWANIA	230V~50Hz	12 V
4.2 A	12-90 Ah	WET MOKRY



No.	V	A	Ah	
82542	12	4.2	12-90	10

- PL Prostownik
- GB Rectifier
- D Batterieladegerät
- RUS Зарядное устройство
- CZ Usměrňovač
- RO Redresor
- H Akkumulátortöltő
- E Rectificador

12 A MAX. PRĄD ŁADOWANIA	230V~50Hz	6 V 12 V
10.3 A	26-210 Ah	WET MOKRY



No.	V	A	Ah max	
82544	6 / 12	10.3	26-210	5

- PL Wskaźnik ciśnienia
- GB Pressure gauge
- D Druckanzeige
- RUS Манометр
- CZ Tlakomer
- RO Indicator de presiune
- H Nyomásmérő
- E Manómetro

0.05-0.3 MPa 0.5-3.0 bar	



No.	MPa	bar	
82611	0.05-0.3	0.5-3.0	10

- PL Prostownik
- GB Rectifier
- D Batterieladegerät
- RUS Зарядное устройство
- CZ Usměrňovač
- RO Redresor
- H Akkumulátortöltő
- E Rectificador

4 A MAX. PRĄD ŁADOWANIA	230V~50Hz	12 V
2.8 A	8-60 Ah	WET MOKRY



No.	V	A	Ah	
82541	12	2.8	8-60	10

- PL Prostownik
- GB Rectifier
- D Batterieladegerät
- RUS Зарядное устройство
- CZ Usměrňovač
- RO Redresor
- H Akkumulátortöltő
- E Rectificador

8 A MAX. PRĄD ŁADOWANIA	230V~50Hz	6 V 12 V
5.8 A	12-120 Ah	WET MOKRY



No.	V	A	Ah	
82543	6 / 12	5.8	12-120	5

- PL Wskaźnik ciśnienia
- GB Pressure gauge
- D Druckanzeige
- RUS Манометр
- CZ Tlakomer
- RO Indicator de presiune
- H Nyomásmérő
- E Manómetro

0.05-0.75 MPa 0.5-7.5 bar	



No.	MPa	bar	
82610	0.05-0.75	0.5-7.5	25/150

- PL Wskaźnik ciśnienia
- GB Pressure gauge
- D Druckanzeige
- RUS Манометр
- CZ Tlakomer
- RO Indicator de presiune
- H Nyomásmérő
- E Manómetro

0.05-0.75 MPa 0.5-7.5 bar	



No.	MPa	bar	
82650	0.05-0.75	0.5-7.5	10/100

- PL Wyciągarka łańcuchowa
- GB Chain block
- D Kettenzug Flaschenzug
- RUS Таль цепная
- CZ Zvedák řetězový
- RO Scripete cu lant
- H Láncos csigasor emelő
- E Cabria de cadena



No.	kg	chain / łańcuch (m)	
80751	1000	3	1
80752	2000	3	1
80753	3000	3	1

- PL Pompka tłokowa nożna
- GB Foot pump
- D Fussluftpumpe mit Manometer
- RUS Насос ножной с манометром
- CZ Nožní pumpa z manometrem
- RO Pompa de picior
- H Lábpumpa nyomásmérővel
- E Bomba de pierna con manometro



No.	MPa	
82005	0.7	5

- PL Pompka tłokowa nożna
- GB Foot pump
- D Fussluftpumpe mit Manometer
- RUS Насос ножной с манометром
- CZ Nožní pumpa z manometrem
- RO Pompa de picior
- H Lábpumpa nyomásmérővel
- E Bomba de pierna con manometro



No.	MPa	
82015	0-0.7	6

- PL Pompka słupkowa z manometrem
- GB Hand pump with manometer
- D Hand-Luftpumpe mit Manometer
- RUS Насос ручной с манометром
- CZ Pumpa z manometrem
- RO Pompa de mana cu manometru
- H Kézi pumpa manométerrel
- E Bomba de barrote con manometro



No.	MPa	
82021	1	10

- PL Pompka nożna z manometrem
- GB Foot pump with manometer
- D Fussluftpumpe mit Manometer
- RUS Насос ножной с манометром
- CZ Nožní pumpa z manometrem
- RO Pompa de picior cu manometru
- H Lábpumpa nyomásmérővel
- E Bomba de pierna con manometro



No.	
82000	20

- PL Pompka tłokowa nożna
- GB Foot pump
- D Fussluftpumpe mit Manometer
- RUS Насос ножной с манометром
- CZ Nožní pumpa z manometrem
- RO Pompa de picior
- H Lábpumpa nyomásmérővel
- E Bomba de pierna con manometro



No.	MPa	
82001	0-0.7	12

- PL Pompka słupkowa ręczna
- GB Hand pump
- D Hand-Luftpumpe
- RUS Насос ручной
- CZ Hustička ruční
- RO Pompa de mana cu manometru
- H Kézi pumpa
- E Bomba de barrote de mano



No.	MPa	
82020	0.3	20

- PL Pompka słupkowa z manometrem
- GB Hand pump with manometer
- D Hand-Luftpumpe mit Manometer
- RUS Насос ручной с манометром
- CZ Pumpa z manometrem
- RO Pompa de mana cu manometru
- H Kézi pumpa manométerrel
- E Bomba de barrote con manometro



No.	MPa	
82022	0.1-1	10

PL Kompresor samochodowy
GB Car air compressor
D Auto-Kompressor
RUS Автомобильный компрессор

CZ Automobilový kompresor
RO Compresor auto
H Autókompresszor
E Compresor de coche

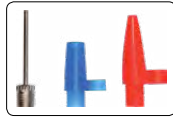
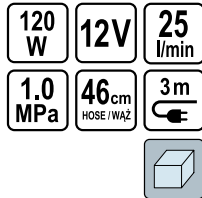

STHOR

No.	W	V	
82105	120	12	36

PL Linka holownicza
GB Tow rope
D Abschleppseil
RUS Трос автомобильный буксировочный



VOREL

No.	kg	
82201	1450	20

PL Linka holownicza
GB Tow rope
D Abschleppseil
RUS Трос автомобильный буксировочный



VOREL

No.	kg	
82209	2500	8

PL Linka holownicza
GB Tow rope
D Abschleppseil
RUS Трос автомобильный буксировочный



VOREL

No.	kg	
82206	3500	12

PL Kompresor samochodowy
GB Car air compressor
D Auto-Kompressor
RUS Автомобильный компрессор

CZ Automobilový kompresor
RO Compresor auto
H Autókompresszor
E Compresor de coche



STHOR

No.	W	V	
82107	120	12	8

PL Linka holownicza
GB Tow rope
D Abschleppseil
RUS Трос автомобильный буксировочный



VOREL

No.	kg	
82205	2500	10

PL Linka holownicza
GB Tow rope
D Abschleppseil
RUS Трос автомобильный буксировочный



VOREL

No.	kg	
82200	3500	12

PL Linka holownicza
GB Tow rope
D Abschleppseil
RUS Трос автомобильный буксировочный



VOREL

No.	kg	
82225	2500	20

PL Linka holownicza
GB Tow rope
D Abschleppseil
RUS Трос автомобильный буксировочный

CZ Tážný provázek
RO Șufă pt. remorcare
H Vonatőkötél
E Cable de remorque



No.	kg	
82227	3500	20

PL Linka holownicza z szeklą
GB Tow rope
D Abschleppseil
RUS Трос автомобильный буксировочный

CZ Tážný provázek
RO Șufă pt. remorcare
H Vonatőkötél
E Cable de remorque



No.	kg	
82234	3500	12

PL Linka holownicza z hakiem
GB Tow rope
D Abschleppseil
RUS Трос автомобильный буксировочный

CZ Tážný provázek
RO Șufă pt. remorcare
H Vonatőkötél
E Cable de remorque



No.	kg	
82233	2500	16

PL Szczotka do czyszczenia klemm
GB Battery clamps cleaner
D Klemmbürste
RUS Щетка для зачистки клемм

CZ Kartáč pro čištění svorek
RO Perie curatat borne auto
H Akkumulátorsaru tisztító kefe
E Cepillo para limpiar bornes



No.	
82445	10/100

PL Linka holownicza z szeklą
GB Tow rope
D Abschleppseil
RUS Трос автомобильный буксировочный

CZ Tážný provázek
RO Șufă pt. remorcare
H Vonatőkötél
E Cable de remorque



No.	kg	
82232	2500	16

PL Linka holownicza z hakiem
GB Tow rope
D Abschleppseil
RUS Трос автомобильный буксировочный

CZ Tážný provázek
RO Șufă pt. remorcare
H Vonatőkötél
E Cable de remorque



No.	kg	
82231	1450	20

PL Szczotka do czyszczenia klemm
GB Battery clamps cleaner
D Klemmbürste
RUS Щетка для зачистки клемм

CZ Kartáč pro čištění svorek
RO Perie curatat borne auto
H Akkumulátorsaru tisztító kefe
E Cepillo para limpiar bornes



No.	
82440	10/160

PL Komplet klemm do akumulatora
GB Battery clamps
D Akku-Polklennen
RUS Клеммы аккумуляторные

CZ Sada svorek na akumulátor
RO Set de cleme pt. acumulator
H Akkumulátorsaru készlet
E Juego de bornes para acumulador



No.	pcs	
82431	2	12/120

PL Próbnik akumulatorowy CZ Akumulátorový zkoušeč
 GB Battery hydrometer RO Instrument de verificare acumulator
 D Batteriesäureprüfer H Akkumulátorpróbaló
 RUS Ареометр аккумуляторный E Probador de acumulador



No.

82520



10/100

PL Skrobaczka do szyb CZ Škrabka na okna
 GB Car window scraper RO Razuiitor gheata
 D Auto-Eiskratzer H Jégkaparó
 RUS Автомобильный скребок E Rascadora para cristales



No.

82910



100

PL Guma do szyb z drewnianą rączką CZ Guma do skel z dřevěnou rukojetí
 GB Window squeegee RO Lamă-ștergător cu miner de lemn pt. geamuri
 D Scheibenreiniger-Holzstiel H Vízlehúzó gumi fa nyéllel
 RUS Стеклоочиститель с резинкой E Goma para cristales con mango de madera



No.

82920



50

PL Lejek CZ Nálevka
 GB Flexible funnel RO Pálnie
 D Trichter H Kétrészes tölcser
 RUS Воронка гибкая E Embudo



VOREL

No.

83001



30

PL Wiązka przewodów awaryjnych CZ Spouštěcí kabele
 GB Boosters cables RO Cabluri de alimentare
 D Starthilfekabel H Indítókábel
 RUS Старт-кабель E Pinzas de arranque



No.

82502

A

200



6

82504

400

6

82506

600

6

PL Szczotka do samochodu CZ Kartač na auto
 GB Eureka duster RO Perie pt. mașină
 D Waschbürste H Autómosó kefe
 RUS Щетка-моп для мытья машин E Cepillo de coche



No.

82939



25/50

PL Lejek CZ Nálevka
 GB Flexible funnel RO Pálnie
 D Trichter H Kétrészes tölcser
 RUS Воронка гибкая E Embudo



VOREL

No.

83000



30

PL Lejek CZ Nálevka
 GB Flexible funnel RO Pálnie
 D Trichter H Kétrészes tölcser
 RUS Воронка гибкая E Embudo



VOREL

No.

83002



30

PL Lejek rolniczy
GB Agricultural funnel
D Landwirtschaftlich trichter
RUS Сельскохозяйственная воронка

CZ Trychtýř zemědělský
RO Pâlnie agricole
H Mezőgazdasági tölcser
E Embudo agricola



No.	diameter / średnica (mm)	☐
83004	210	25

PL Odkurzacz samochodowy
GB Car vacuum cleaner
D Handsauger
RUS Ручной пылесос для автомобиля

CZ Vysavač do auta
RO Aspirator de masina
H Autó porszívó
E Aspirador para coche



No.	W	V	☐
82951	100	12	8

PL Odkurzacz samochodowy
GB Car vacuum cleaner
D Handsauger
RUS Ручной пылесос для автомобиля

CZ Vysavač do auta
RO Aspirator de masina
H Autó porszívó
E Aspirador para coche



No.	W	V	☐
82953	80/120	12	12

PL Lejek
GB Funnel
D Trichter
RUS Воронка

CZ Nálevka
RO Pâlnie
H Kétrészes tölcser
E Embudo



No.	pcs	diameter / średnica (mm)	height / wysokość (mm)	☐
83005	4	52; 76; 100; 120	75; 110; 125; 152	30

PL Odkurzacz samochodowy
GB Car vacuum cleaner
D Handsauger
RUS Ручной пылесос для автомобиля

CZ Vysavač do auta
RO Aspirator de masina
H Autó porszívó
E Aspirador para coche



No.	W	V	☐
82952	100	12	20

PL Odkurzacz samochodowy
GB Car vacuum cleaner
D Handsauger
RUS Ручной пылесос для автомобиля

CZ Vysavač do auta
RO Aspirator de masina
H Autó porszívó
E Aspirador para coche



No.	W	☐
82954	80	20

PL Samochodowy prysznic turystyczny
GB Portable car shower set
D Campingdusche
RUS Портативный автомобиль душ

CZ Mobilní auto sprcha
RO Dus portabil masina
H Autós hordozható zuhany
E Portátil ducha de coche



FEATURES / CECHY:

✓ Taking shower, washing car, washing dishes and others /
Prysznic, mycie samochodu, mycie naczyń i inne

LUND

No.	V	
82991	12	10

PL Apteczka samochodowa
GB First aid kit
D Verbandkasten
RUS Аптечка автомобильная

CZ Příruční lékárnička první pomoci
RO Trusă medicală de prim-ajutor
H Elsősegély doboz
E Botiquin



No.	type	
83260	E-01	10

PL Apteczka samochodowa
GB First aid kit
D Verbandkasten
RUS Аптечка автомобильная

CZ Příruční lékárnička první pomoci
RO Trusă medicală de prim-ajutor
H Elsősegély doboz
E Botiquin



No.	type	
83262	E-03	5

PL Samochodowy prysznic turystyczny
GB Portable car shower set
D Campingdusche
RUS Портативный автомобиль душ

CZ Mobilní auto sprcha
RO Dus portabil masina
H Autós hordozható zuhany
E Portátil ducha de coche

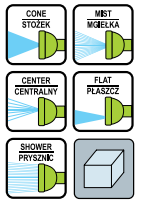

FEATURES / CECHY:

✓ Taking shower, washing car, washing dishes, watering plants and others /
Prysznic, mycie samochodu, mycie naczyń, podlewanie roślin i inne

LUND

No.	V	
82992	12	10

PL Apteczka samochodowa
GB First aid kit
D Verbandkasten
RUS Аптечка автомобильная

CZ Příruční lékárnička první pomoci
RO Trusă medicală de prim-ajutor
H Elsősegély doboz
E Botiquin



No.	type	
83261	E-04	5

PL Apteczka metalowa
GB Metal first aid kit
D Apotheke aus Metall
RUS Металлическая аптечка

CZ Kovová lékárnička
RO Trusă medicală din metal
H Fém elsősegély doboz
E Botiquin de metal



No.	type	dimensions / wymiary (mm)	
83266	E240	240x220x120	1
83267	E300	300x220x120	1

PL Trójkąt ostrzegawczy CZ Výstražný trojúhelník
 GB Vehicle safety triangle RO Triunghi de avertizare
 D Warndreieck H Elakadásjelző háromszög
 RUS Предупреждающий треугольник E Triángulo de emergencia



No.	Icon
83280	40

PL Spinacz bagażu CZ Elastické spínatka
 GB Elastic tie down RO Cordelina elastica
 D Gepäckspinnensatz H Csomagrögzítő pók
 RUS Стяжка для багажа-8 крючков E Pulpo 8-ramion



No.	L (cm)	Ø (mm)	arms / ramiona	Icon
82300	80	8	8	25/50



No.	L (cm)	Ø (mm)	arms / ramiona	Icon
82301	80	8	8	25/50

PL Ściągacze elastyczne CZ Elastické spínatka
 GB Elastic straps RO Cordelina elastica
 D Gummispannseil H Rugalmas feszítő
 RUS Стяжка для багажа E Pulpos



No.	L (cm)	Ø (mm)	pcs	Icon
82305	120	12	2	12/24

PL Taśma do bagażu ze sprzączką CZ Pásky na zavazadla
 GB Ratchet tie down RO Cordelina pt. bagaje cu clichet
 D Spanngurt H Csomagrögzítő pánt
 RUS Ремни для крепления груза с зажимом фиксатором E Cintas para equipaje



No.	L (cm)	W (mm)	pcs	Icon
82331	250	25	2	10/80

PL Ściągacze elastyczne CZ Elastické spínatka
 GB Elastic straps RO Cordelina elastica
 D Gummispannseil H Rugalmas feszítő
 RUS Стяжка для багажа E Pulpos



No.	L (cm)	Ø (mm)	pcs	Icon
82308	80	8	2	20/80
82310	100	8	2	20/80
82315	150	8	2	20/80
82320	200	8	2	20/80

PL Plaskie ściągacze elastyczne CZ Elastické spínatka
 GB Elastic straps RO Cordelina elastica
 D Gummispannseil H Rugalmas feszítő
 RUS Стяжка для багажа E Pulpos



No.	L (cm)	pcs	Icon
82360	80	2	25/50
82370	100	2	20/80

PL Taśma do bagażu ze sprzączką CZ Pásky na zavazadla
 GB Ratchet tie down RO Cordelina pt. bagaje cu clichet
 D Spanngurt H Csomagrögzítő pánt
 RUS Ремни для крепления груза с зажимом фиксатором E Cintas para equipaje



No.	L (m)	W (mm)	Icon
82341	5	25	12/48

PL Taśma do bagażu
 GB Ratchet tie down
 D Spanngurt
 RUS Ремень для крепления багажа с трещоткой

CZ Pás na zavazadla z napínáním
 RO Cordelina pt. bagaje cu clichet
 H Csomagrógzítő pánt feszítővel
 E Cinta para equipaje con carraca



No.	L (m)	daN	W (mm)	Icon
82377	2	1000	35	10
82378	4	1000	35	10
82379	6	1000	35	10
82380	8	1000	35	10

PL Taśma do bagażu
 GB Ratchet tie down
 D Spanngurt
 RUS Ремень для крепления багажа с трещоткой

CZ Pás na zavazadla z napínáním
 RO Cordelina pt. bagaje cu clichet
 H Csomagrógzítő pánt feszítővel
 E Cinta para equipaje con carraca

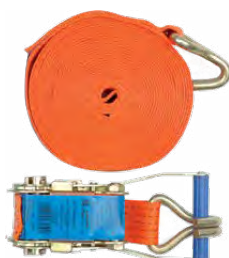

No.	L (m)	daN	W (mm)	Icon
82372	4	1600	50	8
82373	6	1600	50	7
82374	8	1600	50	6
82375	10	1600	50	5
82384	6	2000	50	6
82386	8	2000	50	6
82388	10	2000	50	5
82390	12	2000	50	5

PL Taśma do bagażu
 GB Ratchet tie down
 D Spanngurt
 RUS Ремень для крепления багажа с трещоткой

CZ Pás na zavazadla z napínáním
 RO Cordelina pt. bagaje cu clichet
 H Csomagrógzítő pánt feszítővel
 E Cinta para equipaje con carraca

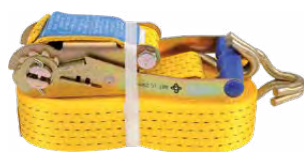

No.	L (m)	daN	W (mm)	Icon
82392	6	2500	50	6
82393	8	2500	50	6
82395	12	2500	50	5

PL Taśma do bagażu
 GB Ratchet tie down
 D Spanngurt
 RUS Ремень для крепления багажа с трещоткой

CZ Pás na zavazadla z napínáním
 RO Cordelina pt. bagaje cu clichet
 H Csomagrógzítő pánt feszítővel
 E Cinta para equipaje con carraca



VOREL

No.	L (m)	W (mm)	Icon
82351	5	25	12/48

PL Taśma do bagażu
 GB Ratchet tie down
 D Spanngurt
 RUS Ремень для крепления багажа с трещоткой

CZ Pás na zavazadla z napínáním
 RO Cordelina pt. bagaje cu clichet
 H Csomagrógzítő pánt feszítővel
 E Cinta para equipaje con carraca

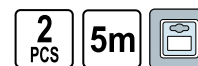

VOREL

No.	L (m)	W (mm)	pcs	Icon
82400	5	25	2	8/16

PL Taśma do bagażu
 GB Ratchet tie down
 D Spanngurt
 RUS Ремень для крепления багажа с трещоткой

CZ Pás na zavazadla z napínáním
 RO Cordelina pt. bagaje cu clichet
 H Csomagrógzítő pánt feszítővel
 E Cinta para equipaje con carraca



VOREL

No.	L (m)	daN	W (mm)	Icon
82401	2	1000	38	12
82402	4	1000	38	12
82403	6	1000	38	12
82404	8	1000	38	12
82405	4	1500	50	6
82406	6	1500	50	6
82407	8	1500	50	6
82408	10	1500	50	6
82409	6	2000	50	6
82410	8	2000	50	6
82411	10	2000	50	6
82412	12	2000	50	6
82413	6	2500	50	6
82414	8	2500	50	6
82415	10	2500	50	6

PL Taśma do bagażu
GB Ratchet tie down
D Spanngurt
RUS Ремень для крепления багажа с трещоткой

CZ Pás na zavazadla z napínáním
RO Cordelina pt. bagaje cu clichet
H Csomagrógzító pánt feszítővel
E Cinta para equipaje con carraca



No.	L (m)	daN	W (mm)	
82343	4	1000	25	20

PL Plandeka
GB Tarpaulin
D Plane
RUS Тент

CZ Plachta
RO Husă
H Ponyva
E Toldo

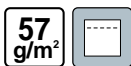

No.	m	g/m ²	
85122	2x3	57	30
85123	3x5	57	20
85124	4x5	57	10
85125	4x6	57	8
85126	5x8	57	5
85128	6x10	57	3
85129	8x12	57	2
85130	10x15	57	2

PL Plandeka
GB Tarpaulin
D Plane
RUS Тент

CZ Plachta
RO Husă
H Ponyva
E Toldo



No.	m	g/m ²	
85020	2x3	90	30
85030	3x5	90	18
85040	4x5	90	9
85050	4x6	90	10
85060	5x8	90	5
85080	6x10	90	4
85090	8x12	90	2
85100	10x15	90	1

PL Taśma do bagażu
GB Ratchet tie down
D Spanngurt
RUS Ремень для крепления багажа с трещоткой

CZ Pás na zavazadla z napínáním
RO Cordelina pt. bagaje cu clichet
H Csomagrógzító pánt feszítővel
E Cinta para equipaje con carraca



No.	L (m)	daN	W (mm)	
82397	5	500	25	20

PL Plandeka
GB Tarpaulin
D Plane
RUS Тент

CZ Plachta
RO Husă
H Ponyva
E Toldo



No.	m	g/m ²	
85112	2x3	75	30
85113	3x5	75	10
85114	4x5	75	10
85115	4x6	75	8
85116	5x8	75	5
85118	6x10	75	3
85119	8x12	75	2
85120	10x15	75	2

PL Uchwyty zaciskowe ze śrubą do mocowania plandek
GB Tarpaulin clips
D Kunststoff Planenhaller
RUS Пластиковый клипс зажим для палаток и тентов
CZ Držáky k zakryvacím plachtám
RO Clame pt. prelate
H Ponyvarógzító klipsz
E Pinzas para lonas

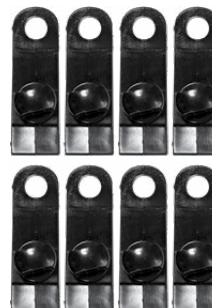

No.	pcs	
85170	8	12/48

PL Uchwyty zaciskowe do mocowania plandek
GB Tarpaulin clips
D Kunststoff Planenhalter
RUS Пластиковый клипс зажим для палаток и тентов

CZ Držáky k zakrývacím plachtám
RO Clame pt. prelate
H Ponyvarögztítő klipsz
E Pinzas para lonas

8
PCS

PP

FOR
TARPAULINS
DO PLANDEK



VOREL

No.	pcs	box
85172	8	72

PL Linka pleciona, elastyczna
GB Elastic rope
D Polypropylen-Gummileine
RUS Шнур эластичный

CZ Lano opletené elastické
RO Funie elastica
H Rugalmas kötél
E Cuerda trenzada

8
ø mm

PP
BRAID
OPLÖT

FOR
TARPAULINS
DO PLANDEK



VOREL

No.	Ø (mm)	L (m)	box
85177	8	15	20
85178	8	30	8

PL Szpilki stalowe do mocowania plandek
GB Metal pegs for fixing tarpaulins
D Metallhaken zum Befestigen von Planen
RUS Металлические кольца для шнуров растяжки тентов и палаток

CZ Kolíčky pro plachtoviny
RO Carigi metalic pt. prelate
H Napellenző csapok
E Piqueta para lonas

10
PCS

180
mm

6
ø mm

FOR TENTS,
TARPAULINS
DO NAMIOTÓW,
PLANDEK

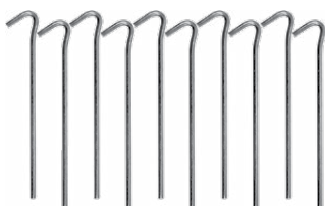

VOREL

No.	pcs	box
85185	10	18/36

PL Taśma klejąca do naprawy plandek
GB Tarpaulin repair tape
D Planen-Reparatur-Klebeband
RUS Самоклеящаяся лента тарпаулиновая, для ремонта тентов

CZ Páska maskovací textilní pro plachtoviny
RO Bandă adezivă de reparații pt. prelate
H Szövetszalag ezüst
E Cinta adhesiva de reparación para lonas

50
mm

8
m

DUCT

FOR
TARPAULINS
DO PLANDEK



VOREL

No.	W (mm)	L (m)	box
85191	50	8	72

PL Uchwyty zaciskowe do mocowania plandek
GB Tarpaulin clips
D Kunststoff Planenhalter
RUS Пластиковый клипс зажим для палаток и тентов

CZ Držáky k zakrývacím plachtám
RO Clame pt. prelate
H Ponyvarögztítő klipsz
E Pinzas para lonas

8
PCS

PE

FOR
TARPAULINS
DO PLANDEK



VOREL

No.	pcs	box
85174	8	12/48

PL Guma mocująca z kulką
GB Ball bungee cords
D Planenspanner Spanngummi mit Kunststoffkugel
RUS Резиновая петля с шариком
CZ Upinaci gumy s plastovú kuličkou
RO Cordelina elastica cu bila fixare
H Ponyva rögzítő gumipök
E Tensor de goma con bola de plástico

8
PCS

200
mm

25
ø mm

FOR TENTS,
TARPAULINS
DO NAMIOTÓW,
PLANDEK



VOREL

No.	pcs	box
85180	8	24/96

PL Taśma klejąca do naprawy plandek
GB Tarpaulin repair tape
D Planen-Reparatur-Klebeband
RUS Самоклеящаяся лента тарпаулиновая, для ремонта тентов

CZ Páska maskovací textilní pro plachtoviny
RO Bandă adezivă de reparații pt. prelate
H Szövetszalag ezüst
E Cinta adhesiva de reparación para lonas

50
mm

8
m

DUCT

FOR
TARPAULINS
DO PLANDEK



VOREL

No.	W (mm)	L (m)	box
85190	50	8	72

50
mm

8
m

DUCT

FOR
TARPAULINS
DO PLANDEK



15

Power tools & accessories
Elektronarzędzia i akcesoria



Power tools POWER UP
Elektronarzędzia POWER UP



244-245

Impact drills	
Wiertarki udarowe.....	244
Cordless tools	
Urządzenia akumulatorowe.....	244
Multi-purpose oscillating tools	
Wielofunkcyjne narzędzia oscylacyjne.....	244
Circular saws	
Pilarki tarczowe.....	245

Power tools STHOR
Elektronarzędzia STHOR



246-259

Impact drills	
Wiertarki udarowe.....	246
Rotary hammers	
Młoty udarowe.....	246
Demolition hammers	
Młoty wyburzeniowe.....	247
Cordless tools	
Urządzenia akumulatorowe.....	247
Electric drill / drivers	
Wiertarko-wkrętarki sieciowe.....	252
Impact wrenches	
Klucze udarowe.....	252
Angle grinders	
Szlifierki kątowe.....	253
Drywall sanders	
Szlifierki do gładzi i tynków.....	253
Multi-purpose oscillating tools	
Wielofunkcyjne narzędzia oscylacyjne.....	254
Orbital sanders	
Szlifierki mimośrodowe.....	254
Finishing sanders	
Szlifierki oscylacyjne.....	254
Belt sanders	
Szlifierki taśmowe.....	254
Jig saws	
Wyrzynarki.....	254
Circular saws	
Pilarki tarczowe.....	255
Planers	
Strugi.....	255
Hot air guns	
Opalarki.....	255
Blowers	
Dmuchawy.....	256
Glue guns	
Pistolety do klejenia.....	256
Workshop vacuum cleaners	
Odkurzacze warsztatowe.....	256
Soldering guns	
Lutownice.....	257
Paint & mortar mixers	
Mieszarki do zapraw i farb.....	258
Bench tools	
Elektronarzędzia stołowe.....	258
Pipe welders	
Zgrzewarki do rur.....	258
Water pumps	
Pompy wodne.....	259

Power tools LUND
Elektronarzędzia LUND

.....260-263



Rotary hammers Młoty udarowe.....	260
Knives for polystyrene foam Noże do styropianu.....	260
Angle grinders Szlifierki kątowe.....	260
Finishing sanders Szlifierki oscylacyjne.....	260
Car polishers Polerki samochodowe.....	260
Planers Strugi.....	261
Hot air guns Opalarki.....	261
Glue guns Pistolety do klejenia.....	261
Soldering guns Lutownice.....	262
Pipe welders Zgrzewarki do rur.....	263

Power tools FLO
Elektronarzędzia FLO

.....264-267



Cordless tools Urządzenia akumulatorowe.....	264
Water pumps Pompy wodne.....	264
Grass trimmers Podkaszarki.....	266
Hedge shears Nożyce do żywopłotu.....	266

Power tools
Elektronarzędzia

268

Soldering guns

Lutownice..... 268

Accessories
Akcesoria

268-275

Grass trimmer lines

Żyłki tnące do podkaszarek..... 268

Drill chucks

Uchwyt wiertarskie..... 270

Adapters

Adaptery..... 271

Drill bit sharpeners

Ostrzałki do wiertel..... 271

Stands for power tools

Statywy do elektronarzędzi..... 271

Spare blades, brushes, etc. for power tools

Zapasowe ostrza, szczotki, końcówki do elektronarzędzi..... 272

Soldering iron accessories

Akcesoria do lutownic..... 273

Gasoline water pump accessories

Akcesoria do pomp spalinowych..... 275

PL Wiertarka uderowa
GB Impact drill
D Schlagbohrmaschine
RUS Дрель ударная
CZ Nárazová vrtáčka
RO Masina de gaurit
H Kezelési utasítás
E Taladradora de percusión



POWERUP

$L_{pa} = 92,0 \pm 3,0$ dB; $L_{wa} = 103,0 \pm 3,0$ dB; $a_n = 3,76 \pm 1,5 / 15,44 \pm 1,5$ m/s²

No.	W	min-1	
79013	710	0-2900	6

PL Zakrećarka uderowa
GB Impact wrench
D Schlagschrauber
RUS Ударный гайковерт
CZ Rázový šroubovák
RO Mașină de infilțat cu percuzie
H Útvecsavarozó
E Atomilladora de impacto



POWERUP

$L_{pa} = 91,37 \pm 3,0$ dB; $L_{wa} = 102,37 \pm 3,0$ dB; $a_n = 1,99 \pm 1,5$ m/s²

No.	V	min-1	
78960	12	0-2300	10

PL Wiertarko-wkręćarka akumulatorowa
GB Cordless drill
D Akkuschrauber
RUS Аккумуляторная дрель-шурупверт
CZ Vrtáčko-utahovák akumulátorový
RO Bormașină-șurubelniță cu acumulator
H Akkumulátoros fűrógép-csavarbehajtó
E Taladradora - atornilladora acu.

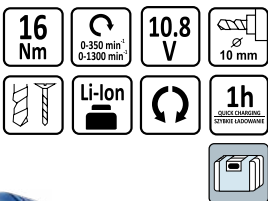

POWERUP

$L_{pa} = 66,9 \pm 3,0$ dB; $L_{wa} = 77,9 \pm 3,0$ dB; $a_n = 0,473 \pm 1,5$ m/s²

No.	V	min-1	Ø (mm)	
78970	10.8	0-350 / 0-1300	10	5

PL Wiertarko-wkręćarka akumulatorowa
GB Cordless drill
D Akkuschrauber
RUS Аккумуляторная дрель-шурупверт
CZ Vrtáčko-utahovák akumulátorový
RO Bormașină-șurubelniță cu acumulator
H Akkumulátoros fűrógép-csavarbehajtó
E Taladradora - atornilladora acu.

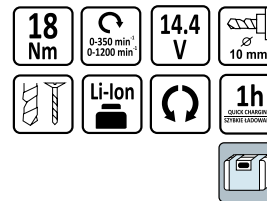

POWERUP

$L_{pa} = 63,60 \pm 3,0$ dB; $L_{wa} = 74,60 \pm 3,0$ dB; $a_n = 1,068 \pm 1,5 / 1,956 \pm 1,5$ m/s²

No.	V	min-1	Ø (mm)	
78971	14.4	0-350 / 0-1200	10	5

PL Wielofunkcyjne narzędzie oscylacyjne
GB Multi-purpose oscillating tool
D Multifunktionales Oszillationswerkzeug
RUS Многофункциональный инструмент
CZ Multifunkční oscilační nářadí
RO Unealtă multifuncțională oscilantă
H Multifunkciós rezgő szerszám
E Herramienta oscilatoria multiusos

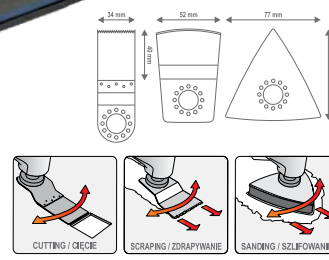
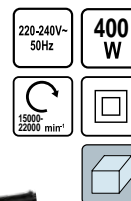

POWERUP

$L_{pa} = 84 \pm 3$ dB; $L_{wa} = 95 \pm 3$ dB; $a_n = 3,86 \pm 1,5$ m/s²

No.	W	min-1	
79239	400	15000-22000	6

- PL Pilarka ręczna
- GB Circular saw
- D Handkreissäge
- RUS Дисковая пила
- CZ Pila kotoučová
- RO Fierastrau circular
- H Kézi körfűrészgép
- E Sierra de disco

230V~ 50Hz	1700 W	4000 min ⁻¹	
 Ø100mm 125 x 22.21 x 3.8 x2	 0-28 mm	 14(20-25)	



$L_{pA} = 101,88 \pm 3,0$ dB; $L_{wA} = 112,88 \pm 3,0$ dB; $a_b = 9,430 \pm 1,5 / 9,564 \pm 1,5$ m/s²

No.	W	min-1	
79275	1700	4000	2

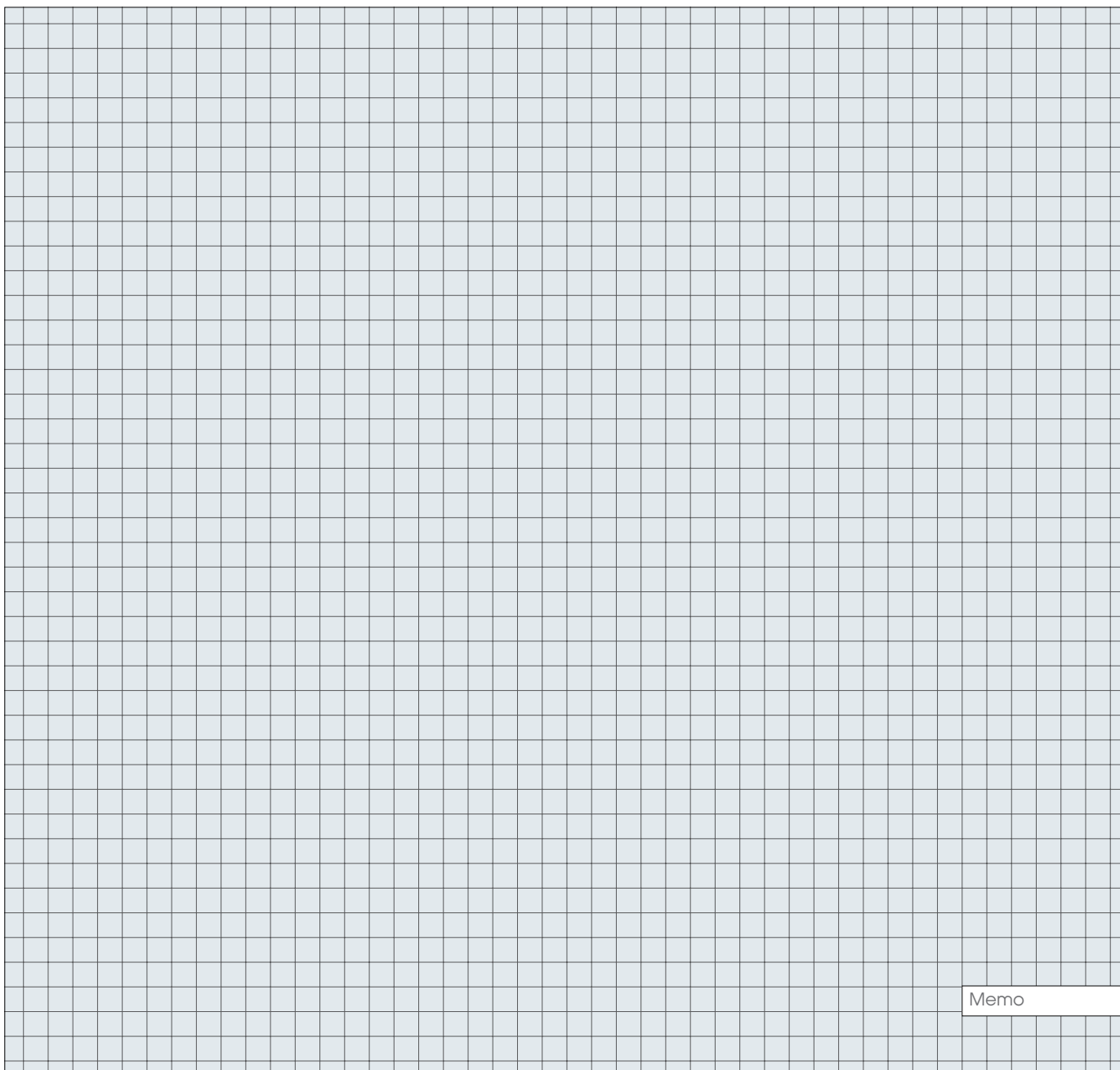

Memo

PL Wiertarka udarowa
GB Impact drill
D Schlagbohrmaschine
RUS Дрель ударная
CZ Nárazová vrtačka
RO Masina de gaurit
H Kezelési utasítás
E Taladradora de percusión

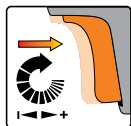
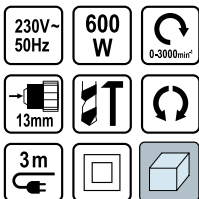

$L_{pa} = 90,0 \pm 3,0$ dB; $L_{wa} = 101,0 \pm 3,0$ dB; $a_n = 2,39 \pm 1,5 / 7,67 \pm 1,5$ m/s²

No.	W	min-1	
78992	600	0-3000	10

PL Wiertarka udarowa
GB Impact drill
D Schlagbohrmaschine
RUS Дрель ударная
CZ Nárazová vrtačka
RO Masina de gaurit
H Kezelési utasítás
E Taladradora de percusión

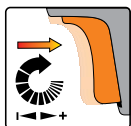
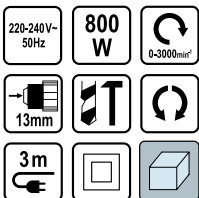

$L_{pa} = 98,06 \pm 3,0$ dB; $L_{wa} = 109,06 \pm 3,0$ dB; $a_n = 5,726 \pm 1,5 / 17,116 \pm 1,5$ m/s²

No.	W	min-1	
78997	800	0-3000	10

PL Motowiertarka
GB Rotary hammer
D Bohrhämmer
RUS Перфоратор
CZ Vrtací kladivo
RO Ciocan rotopercutor
H Fúrókalapács
E Martillo perforador

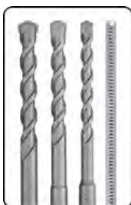

$L_{pa} = 87 \pm 3$ dB; $L_{wa} = 98 \pm 3$ dB; $a_n = 12,353 \pm 1,5 / 9,433 \pm 1,5$ m/s²

No.	W	min-1	
79049	500	0-850	5

PL Wiertarka udarowa
GB Impact drill
D Schlagbohrmaschine
RUS Дрель ударная
CZ Nárazová vrtačka
RO Masina de gaurit
H Kezelési utasítás
E Taladradora de percusión

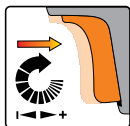
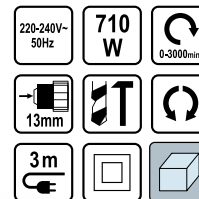

$L_{pa} = 98,06 \pm 3,0$ dB; $L_{wa} = 109,06 \pm 3,0$ dB; $a_n = 5,726 \pm 1,5 / 17,116 \pm 1,5$ m/s²

No.	W	min-1	
78995	710	0-3000	10

PL Wiertarka udarowa
GB Impact drill
D Schlagbohrmaschine
RUS Дрель ударная
CZ Nárazová vrtačka
RO Masina de gaurit
H Kezelési utasítás
E Taladradora de percusión

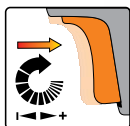

$L_{pa} = 78,0 \pm 3,0$ dB; $L_{wa} = 89,0 \pm 3,0$ dB; $a_n = 2,93 \pm 1,5 / 8,43 \pm 1,5$ m/s²

No.	W	min-1	
79023	910	0-3000	10

PL Młotowiertarka SDS plus
GB Rotary hammer
D Bohrhämmer
RUS Перфоратор
CZ Vrtací kladivo
RO Ciocan rotopercutor
H Fúrókalapács
E Martillo perforador



$L_{pa} = 92 \pm 3$ dB; $L_{wa} = 103 \pm 3$ dB; $a_n = 14,377 \pm 1,5 / 11,618 \pm 1,5$ m/s²

No.	W	min-1	
79054	620	0-870	5

- PL Młotowiertarka SDS plus
- GB Rotary hammer
- D Bohrhammer
- RUS Перфоратор
- CZ Vrtací kladivo
- RO Ciocan rotopercutor
- H Fúrókalapács
- E Martillo perforador

230V~50Hz 800 W 0-1000 min⁻¹ 0-5000 min⁻¹ 3.5J IMPACT ENERGY (MŁOTOWIENIE UDARU)

SDS PLUS

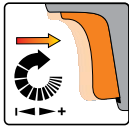

$L_{pA} = 89,4 \pm 3,0$ dB; $L_{wA} = 100,4 \pm 3,0$ dB; $a_n = 14,936 \pm 1,5 / 14,898 \pm 1,5$ m/s²

No.	W	min-1	
79053	800	0-1000	4

- PL Młot udarowy
- GB Rotary hammer
- D Bohrhammer
- RUS Перфоратор
- CZ Přerážecí kladivo
- RO Ciocan percutatnt
- H Fúrókalapács-gép
- E Martillo de percusión

230V~50Hz 1100 W 800 min⁻¹ 3300 min⁻¹

SDS PLUS



STHOR

$L_{pA} = 92,0 \pm 3,0$ dB; $L_{wA} = 103,0 \pm 3,0$ dB; $a_n = 16,885 (14,718) \pm 1,5$ m/s²

No.	W	min-1	
79036	1100	800	3

- PL Wkrętak akumulatorowy
- GB Cordless screwdriver
- D Akku-schrauber
- RUS Аккумуляторный шуруповерт
- CZ Utahovák akumulátorový
- RO Șurubelniță cu acumulator
- H Akkumulátoros csavarbehajtó
- E Herramienta de resistencia para soldar

3,6 V 1300 mAh Li-Ion

3.0 Nm 180 min⁻¹

LED CHARGE INDICATOR WSKAZNIK ŁADUNKOWANIA



STHOR

$L_{pA} = 61,8 \pm 3,0$; $L_{wA} = 72,8 \pm 3,0$ dB; $a_n = 0,33 \pm 1,5$ m/s²

No.	V		
78150	3.6		40

- PL Młotowiertarka SDS plus
- GB Rotary hammer
- D Bohrhammer
- RUS Перфоратор
- CZ Vrtací kladivo
- RO Ciocan rotopercutor
- H Fúrókalapács
- E Martillo perforador

230-240V~50Hz 800 W SDS PLUS 0-1000 min⁻¹ 5100 min⁻¹

2.6J IMPACT ENERGY (ENERGIA UDARU)



$L_{pA} = 90,4 \pm 3,0$ dB; $L_{wA} = 101,4 \pm 3,0$ dB; $a_n = 16,5 \pm 1,5$ m/s²

No.	W	min-1	
79076	800	0-1000	4

- PL Młot wyburzeniowy
- GB Demolition hammer
- D Abbruchhammer
- RUS Электрический отбойный молоток
- CZ Bourací kladivo
- RO Ciocan demolator
- H Bontókalapács
- E Martillo de demolición

230V~50Hz 1500 W 1900 min⁻¹

45J IMPACT ENERGY (ENERGIA UDARU)

2 pcs OIL COOLING (CHLÓDZENIE OLEJEM)



STHOR

$L_{pA} = 92,9 \pm 3,0$ dB; $L_{wA} = 104 \pm 3,0$ dB; $a_n = 20,706 \pm 1,5$ m/s²

No.	W	min-1	
79090	1500	1900	1

- PL Wiertarko-wkrętarka akumulatorowa
- GB Cordless drill / driver
- D Akkuschauber-und-Bohrer
- RUS Аккумуляторная дрель с шуруповертом
- CZ Akumulátorový vrtací sroubovák
- RO Bormasina-surubelnita cu acumulator
- H Akkumulátoros furo-csavarhuzo
- E Taladro-desarmador con acumulador

12V 1.5 Ah 24 Nm

0-350 min⁻¹ / 0-1300 min⁻¹ Li-Ion

1h QUICK CHARGING (SZYBWE ŁADUNKOWANIE)

WORK AREA LIGHTING (OSWIEPLENIENIE OBSZARU PRACY)

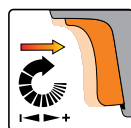

$L_{pA} = 70,72 \pm 3,0$; $L_{wA} = 87,72 \pm 3,0$ dB; $a_n = 1,782 \pm 1,5$ m/s²

No.	V	min-1	Ø (mm)	
78101	12	0-350 / 0-1300	1-10	5

- PL Akumulatorowa wiertarko-wkrętarka (tylko narzędzie)
- GB Cordless drill / driver (tool only)
- D Akkuschrauber-und-Bohrer (nur das Gerät)
- RUS Аккумуляторная дрель с шуруповертом (только инструмент)
- CZ Akumulátorový vrtací šroubovák (pouze nářadí)
- RO Mașină de găurit / înșurubat cu acumulator (numai sculă)
- H Akkus fűrcsavarozók (csak a szerszámot)
- E Taladro / atornillador a batería (herramienta solamente)

12V 1.5 Ah 24 Nm

0-350 min⁻¹ 0-1300 min⁻¹ 1-10 mm Li-Ion

1h QUICK CHARGING SYSTEM ŁADOWANIE

WORK AREA LIGHTING OSWIETLENIE OBSZARU PRACY



Battery not included
Akumulatora nie dołączono

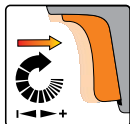

$L_{pa} = 70,72 \pm 3,0$; $L_{wa} = 87,72 \pm 3,0$ dB; $a_n = 1,782 \pm 1,5$ m/s²

No.	V	min-1	Ø (mm)	⊠
78102	12	0-350 / 0-1300	1-10	5

- PL Akumulatorowa wiertarko-wkrętarka (tylko narzędzie)
- GB Cordless drill / driver (tool only)
- D Akkuschrauber-und-Bohrer (nur das Gerät)
- RUS Аккумуляторная дрель с шуруповертом (только инструмент)
- CZ Akumulátorový vrtací šroubovák (pouze nářadí)
- RO Mașină de găurit / înșurubat cu acumulator (numai sculă)
- H Akkus fűrcsavarozók (csak a szerszámot)
- E Taladro / atornillador a batería (herramienta solamente)

12V 1.5 Ah 24 Nm

0-350 min⁻¹ 0-1300 min⁻¹ 1-10 mm 6.3 mm 1/4" Li-Ion

1h QUICK CHARGING SYSTEM ŁADOWANIE

WORK AREA LIGHTING OSWIETLENIE OBSZARU PRACY



Battery not included
Akumulatora nie dołączono

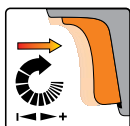

$L_{pa} = 70,72 \pm 3,0$ dB; $L_{wa} = 87,72 \pm 3,0$ dB; $a_n = 1,782 \pm 1,5$ m/s²

No.	V	min-1	Ø (mm)	⊠
78106	12	0-350 / 0-1300	1-10	5

- PL Akumulatorowa wiertarko-wkrętarka udarowa
- GB Cordless impact drill / driver
- D Akku-Schlagbohrschrauber
- RUS Аккумуляторный ударный дрель-шуруповерт
- CZ Akumulátorový nárazový šroubovák s příklepem
- RO Mașină de găurit cu percucie cu acumulator
- H Akkus ütvefűrógép
- E Taladro / atornillador con percusión a batería

12V 1.5 Ah 24 Nm

0-350 min⁻¹ 0-1300 min⁻¹ 1-10 mm Li-Ion

1h QUICK CHARGING SYSTEM ŁADOWANIE

WORK AREA LIGHTING OSWIETLENIE OBSZARU PRACY

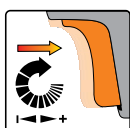

$L_{pa} = 82,2 \pm 3,0$ dB; $L_{wa} = 93,2 \pm 3,0$ dB; $a_n = 13,13 \pm 1,5 / 1,782 \pm 1,5$ m/s²

No.	V	min-1	Ø (mm)	⊠
78111	12	0-350 / 0-1300	1-10	5

- PL Wiertarko-wkrętarka akumulatorowa
- GB Cordless drill / driver
- D Akkuschrauber-und-Bohrer
- RUS Аккумуляторная дрель с шуруповертом
- CZ Akumulátorový vrtací šroubovák
- RO Bormasina-surubelita cu acumulator
- H Akkus fűrcsavarozók (csak a szerszámot)
- E Taladro-desarmador con acumulador

12V 1.5 Ah 24 Nm

0-350 min⁻¹ 0-1300 min⁻¹ 1-10 mm 6.3 mm 1/4" Li-Ion

1h QUICK CHARGING SYSTEM ŁADOWANIE

WORK AREA LIGHTING OSWIETLENIE OBSZARU PRACY

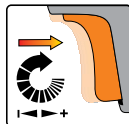

$L_{pa} = 70,72 \pm 3,0$ dB; $L_{wa} = 87,72 \pm 3,0$ dB; $a_n = 1,782 \pm 1,5$ m/s²

No.	V	min-1	Ø (mm)	⊠
78105	12	0-350 / 0-1300	1-10	5

- PL Akumulatorowa wiertarko-wkrętarka udarowa
- GB Cordless impact drill / driver
- D Akku-Schlagbohrschrauber
- RUS Аккумуляторный ударный дрель-шуруповерт
- CZ Akumulátorový nárazový šroubovák s příklepem
- RO Mașină de găurit cu percucie cu acumulator
- H Akkus ütvefűrógép
- E Taladro / atornillador con percusión a batería

12V 1.5 Ah 24 Nm

0-350 min⁻¹ 0-1300 min⁻¹ 1-10 mm Li-Ion

1h QUICK CHARGING SYSTEM ŁADOWANIE

WORK AREA LIGHTING OSWIETLENIE OBSZARU PRACY

x2

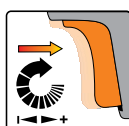

$L_{pa} = 82,2 \pm 3,0$ dB; $L_{wa} = 93,2 \pm 3,0$ dB; $a_n = 13,13 \pm 1,5 / 1,782 \pm 1,5$ m/s²

No.	V	min-1	Ø (mm)	⊠
78110	12	0-350 / 0-1300	1-10	5

- PL Akumulatorowa wiertarko-wkrętarka (tylko narzędzie)
- GB Cordless drill / driver (tool only)
- D Akkuschrauber-und-Bohrer (nur das Gerät)
- RUS Аккумуляторная дрель с шуруповертом (только инструмент)
- CZ Akumulátorový vrtací šroubovák (pouze nářadí)
- RO Mașină de găurit / înșurubat cu acumulator (numai sculă)
- H Akkus fűrcsavarozók (csak a szerszámot)
- E Taladro / atornillador a batería (herramienta solamente)

12V 1.5 Ah 24 Nm

0-350 min⁻¹ 0-1300 min⁻¹ 1-10 mm Li-Ion

1h QUICK CHARGING SYSTEM ŁADOWANIE

WORK AREA LIGHTING OSWIETLENIE OBSZARU PRACY

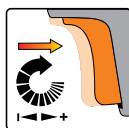

$L_{pa} = 82,2 \pm 3,0$ dB; $L_{wa} = 93,2 \pm 3,0$ dB; $a_n = 13,13 \pm 1,5 / 1,782 \pm 1,5$ m/s²

No.	V	min-1	Ø (mm)	⊠
78112	12	0-350 / 0-1300	1-10	5

- PL Akumulatorowa zakrećarka udarowa
- GB Cordless impact screwdriver
- D Akku-Schlagbohrschrauber
- RUS Аккумуляторный ударный гайковёрт
- CZ Akumulátorový rázový uťahovák
- RO Şurubelniţă cu impact cu acumulator
- H Akkus ütvecsavarozó
- E Atornillador de impacto a batería

12V 1.5 Ah 110 Nm

0-2300 min⁻¹ 1/4" 6.3 mm Li-Ion

1h QUICK CHARGING SZYBIE ŁADOWANIE

WORK AREA LIGHTING OŚWIETLENIE OBSZARU PRACY

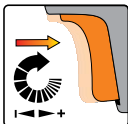

$L_{pA} = 70,76 \pm 3,0$ dB; $L_{wA} = 81,76 \pm 3,0$ dB; $a_n = 1,71 \pm 1,5$ m/s²

No.	V	min-1	
78115	12	0-2300	5

- PL Akumulatorowa wyrzynarka
- GB Cordless jig saw
- D Akku-Stichsäge
- RUS Аккумуляторная лобзиковая пила
- CZ Akumulátorová přímočará píla
- RO Akkus szűrőfűrész
- H Ferástráú vertical cu acumulator
- E Sierra de calar a batería

12V 1.5 Ah 2100 min⁻¹

Li-Ion 50 mm 5 mm

1h QUICK CHARGING SZYBIE ŁADOWANIE

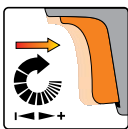

$L_{pA} = 88,2 \pm 3,0$ dB; $L_{wA} = 99,2 \pm 3,0$ dB; $a_n = 4,300 \pm 1,5 / 5,154 \pm 1,5$ m/s²

No.	V	min-1	
78121	12	2100	5

- PL Akumulatorowe wielofunkcyjne narzędzie oscylacyjne
- GB Cordless multi-purpose oscillating tool
- D Akku-Multifunktionswerkzeug
- RUS Аккумуляторный многофункциональный инструмент
- CZ Akumulátorová multifunkční píla
- RO Maşină multifuncţională cu acumulator
- H Akkus multifunkcionális vágószerszám
- E Multiherramienta a batería

12V 1.5 Ah

5000-18000 min⁻¹ Li-Ion

1h QUICK CHARGING SZYBIE ŁADOWANIE



$L_{pA} = 94,0 \pm 3,0$ dB; $L_{wA} = 105,0 \pm 3,0$ dB; $a_n = 11,240 \pm 1,5$ m/s²

No.	V	min-1	
78123	12	5000-18000	5

- PL Akumulatorowa zakrećarka udarowa (tylko narzędzie)
- GB Cordless impact screwdriver (tool only)
- D Akku-Schlagbohrschrauber (nur das Gerät)
- RUS Аккумуляторный ударный гайковёрт (только инструмент)
- CZ Akumulátorový rázový uťahovák (pouze nářadí)
- RO Şurubelniţă cu impact cu acumulator (numai sculă)
- H Akkus ütvecsavarozó (csak a szerszámot)
- E Atornillador de impacto a batería (herramienta solamente)

12V 1.5 Ah 110 Nm

0-2300 min⁻¹ 1/4" 6.3 mm Li-Ion

1h QUICK CHARGING SZYBIE ŁADOWANIE

WORK AREA LIGHTING OŚWIETLENIE OBSZARU PRACY



Battery not included
Akumulatora nie dołączono

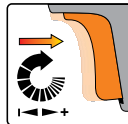

$L_{pA} = 70,76 \pm 3,0$ dB; $L_{wA} = 81,76 \pm 3,0$ dB; $a_n = 1,71 \pm 1,5$ m/s²

No.	V	min-1	
78116	12	0-2300	5

- PL Akumulatorowa wyrzynarka (tylko narzędzie)
- GB Cordless jig saw (tool only)
- D Akku-Stichsäge (nur das Gerät)
- RUS Аккумуляторная лобзиковая пила (только инструмент)
- CZ Akumulátorová přímočará píla (pouze nářadí)
- RO Akkus szűrőfűrész (csak a szerszámot)
- H Ferástráú vertical cu acumulator (numai sculă)
- E Sierra de calar a batería (herramienta solamente)

12V 1.5 Ah 2100 min⁻¹

Li-Ion 50 mm 5 mm

1h QUICK CHARGING SZYBIE ŁADOWANIE



Battery not included
Akumulatora nie dołączono

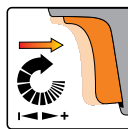

$L_{pA} = 88,2 \pm 3,0$ dB; $L_{wA} = 99,2 \pm 3,0$ dB; $a_n = 4,300 \pm 1,5 / 5,154 \pm 1,5$ m/s²

No.	V	min-1	
78122	12	2100	5

- PL Akumulatorowe wielofunkcyjne narzędzie oscylacyjne (tylko narzędzie)
- GB Cordless multi-purpose oscillating tool (tool only)
- D Akku-Multifunktionswerkzeug (nur das Gerät)
- RUS Аккумуляторный многофункциональный инструмент (только инструмент)
- CZ Akumulátorová multifunkční píla (pouze nářadí)
- RO Maşină multifuncţională cu acumulator (numai sculă)
- H Akkus multifunkcionális vágószerszám (csak a szerszámot)
- E Multiherramienta a batería (herramienta solamente)

12V 1.5 Ah

5000-18000 min⁻¹ Li-Ion

1h QUICK CHARGING SZYBIE ŁADOWANIE



Battery not included
Akumulatora nie dołączono

$L_{pA} = 94,0 \pm 3,0$ dB; $L_{wA} = 105,0 \pm 3,0$ dB; $a_n = 11,240 \pm 1,5$ m/s²

No.	V	min-1	
78124	12	5000-18000	10

PL Akumulatorowa szlifierka wielofunkcyjna
 GB Cordless mini grinder
 D Akku- Mehrzweckschleifmaschine
 RUS Аккумуляторный шлифовальная машина
 CZ Akumulátorová všeúčelová bruska
 RO Mașina de șlefuit multifuncțională cu acumulator
 H Akkus daugiafunkcis šlifuoškis
 E Lijadora multifunción a batería

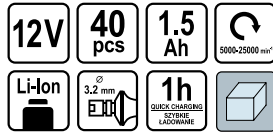

$L_{pa} = 70,9 \pm 3,0$ dB; $L_{wa} = 81,9 \pm 3,0$ dB; $a_n = 34,25 \pm 1,5$ m/s²

No.	V	min-1	☐
78127	12	5000-25000	5

PL Akumulator
 GB Battery
 D Akkumulator
 RUS Аккумулятор

CZ Akumulátor
 RO Acumulatorul
 H Akkumulátor
 E Acumulador

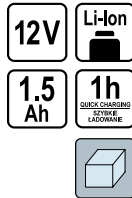

No.	V	☐
78130	12	30

PL Wiertarko-wkrętarzka akumulatorowa
 GB Cordless drill
 D Akkuschrauber
 RUS Аккумуляторная дрель-шурупверт
 CZ Vrtáčko-utahovák akumulátorový
 RO Bormașină-șurubelniță cu acumulator
 H Akkumulátoros fűrógép-csavarbehajtó
 E Taladradora - atornilladora acu.

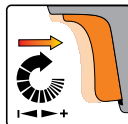
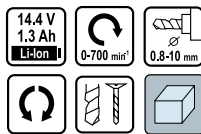

$L_{pa} = 87,0 \pm 3,0$ dB; $L_{wa} = 98,0 \pm 3,0$ dB; $a_n = 1,292 \pm 1,5 / 2,312 \pm 1,5$ m/s²

No.	V	min-1	∅ (mm)	☐
78982	14.4	0-700	0.8-10	5

PL Akumulatorowa szlifierka wielofunkcyjna (tylko narzędzie)
 GB Cordless mini grinder (tool only)
 D Akku- Mehrzweckschleifmaschine (nur das Gerät)
 RUS Аккумуляторный шлифовальная машина (только инструмент)
 CZ Akumulátorová všeúčelová bruska (pouze nářadí)
 RO Mașina de șlefuit multifuncțională cu acumulator (numai sculă)
 H Akkus daugiafunkcis šlifuoškis (csak a szerszámot)
 E Lijadora multifunción a batería (herramienta solamente)

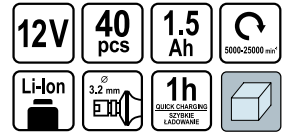

$L_{pa} = 70,9 \pm 3,0$ dB; $L_{wa} = 81,9 \pm 3,0$ dB; $a_n = 34,25 \pm 1,5$ m/s²

No.	V	min-1	☐
78128	12	5000-25000	10

PL Wiertarko-wkrętarzka akumulatorowa
 GB Cordless drill
 D Akkuschrauber
 RUS Аккумуляторная дрель-шурупверт

CZ Vrtáčko-utahovák akumulátorový
 RO Bormașină-șurubelniță cu acumulator
 H Akkumulátoros fűrógép-csavarbehajtó
 E Taladradora - atornilladora acu.

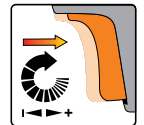
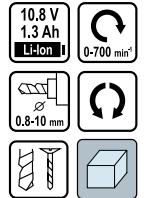

$L_{pa} = 89,0 \pm 3,0$ dB; $L_{wa} = 100,0 \pm 3,0$ dB; $a_n = 0,854 \pm 1,5 / 2,069 \pm 1,5$ m/s²

No.	V	min-1	∅ (mm)	☐
78981	10.8	0-700	0.8-10	5

PL Wiertarko-wkrętarzka akumulatorowa
 GB Cordless drill
 D Akkuschrauber
 RUS Аккумуляторная дрель-шурупверт
 CZ Vrtáčko-utahovák akumulátorový
 RO Bormașină-șurubelniță cu acumulator
 H Akkumulátoros fűrógép-csavarbehajtó
 E Taladradora - atornilladora acu.

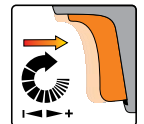
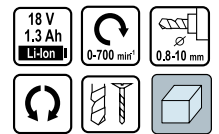

$L_{pa} = 89,0 \pm 3,0$ dB; $L_{wa} = 100,0 \pm 3,0$ dB; $a_n = 1,001 \pm 1,5 / 2,629 \pm 1,5$ m/s²

No.	V	min-1	∅ (mm)	☐
78983	18	0-700	0.8-10	5

PL Akumulator
GB Battery
D Akkumulator
RUS Аккумулятор

CZ Akumulátor
RO Acumulatorul
H Akkumulátor
E Acumulador



No.	V	for / dla	☐
78985	10.8	78118; 78981	50
78986	14.4	78982	50
78987	18	78972; 78974; 78961; 78983	50

PL Zakrećarka udarowa
GB Impact wrench
D Schlagschrauber
RUS Ударный гайковерт

CZ Rázový šroubovák
RO Mașină de infilțat cu percucie
H Útvecsavarozó
E Atonillador de impacto

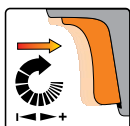

$L_{pa} = 91,54 \pm 3,0$ dB; $L_{wa} = 102,54 \pm 3,0$ dB; $a_h = 51,45 \pm 1,5$ m/s²



No.	V	min-1	☐
78961	18	0-2300	5

PL Wiertarko-wkręćarka akumulatorowa
GB Cordless drill / driver
D Akkuschrauber-und-Bohrer
RUS Аккумуляторная дрель с шуруповертом
CZ Akumulátorový vrtačí sroubovák
RO Bormasina-surubelnita cu acumulator
H Akkumulátoros furo-csavarhuzo
E Taladro-desarmador con acumulador

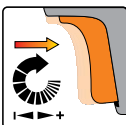
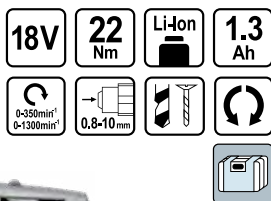

$L_{pa} = 89,0 \pm 3,0$ dB; $L_{wa} = 100,0 \pm 3,0$ dB; $a_h = 1,001 \pm 1,5 / 2,629 \pm 1,5$ m/s²



No.	V	min-1	Ø (mm)	☐
78972	18	0-350; 0-1300	0.8-10	5

PL Ładowarka
GB Battery charger
D Ladegerät
RUS Зарядное устройство

CZ Nabíječka baterií
RO Redresor
H Akkumulátortöltő
E Rectificador



No.	for / dia	☐
79087	15V --- 400mA 79084	30
79088	18V --- 400mA 79085	30
79089	24V --- 400mA 79086	20

PL Akumulatorowa wiertarko-wkręćarka udarowa
GB Cordless impact drill / driver
D Akku-Schlagbohrschrauber
RUS Аккумуляторный ударный дрель-шуруповерт
CZ Akumulátorový nárazový šroubovák s príklepem
RO Mașină de găurit cu percucie cu acumulator
H Akkus ütvefűrógép
E Taladro / atomillador con percusión a batería

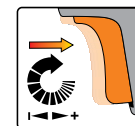

$L_{pa} = 87,43 \pm 3,0$ dB; $L_{wa} = 98,43 \pm 3,0$ dB; $a_h = 12,48 \pm 1,5$ m/s²



No.	V	min-1	Ø (mm)	☐
78968	18	0-900	10	3

PL Akumulatorowa wiertarko-wkręćarka udarowa
GB Cordless impact drill / driver
D Akku-Schlagbohrschrauber
RUS Аккумуляторный ударный дрель-шуруповерт
CZ Akumulátorový nárazový šroubovák s príklepem
RO Mașină de găurit cu percucie cu acumulator
H Akkus ütvefűrógép
E Taladro / atomillador con percusión a batería

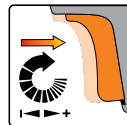

$L_{pa} = 89,0 \pm 3,0$ dB; $L_{wa} = 100,0 \pm 3,0$ dB; $a_h = 15,25 \pm 1,5$ m/s²



No.	V	min-1	Ø (mm)	☐
78974	18	0-350; 0-1300	0.8-10	5

- PL Akumulatorowy pistolet do klejenia
- GB Cordless glue gun
- D Heissklebepistole
- RUS Пистолет для клея
- CZ Pistolet na lepení
- RO Pistol pt. lipit
- H Ragasztópisztoly
- E Pistola de cola



7.2V	1.3 Ah
25 W	3x 7.2mm
Li-Ion	NO OIL NO GREASE
15s FAST BOND Szybkie Nadziejwanie	WORK TIME CZAS PRACY 45 min



No.	V	
78154	7.2	10

- PL Wiertarko-wkrętarka sieciowa
- GB Electric drill / driver
- D Netzbohrschrauber
- RUS Сетевая дрель-шурупверт
- CZ Síťová vrtačka / šroubovák
- RO Bormasina – surubelnita, de retea
- H Halozati furocsavarozó
- E Taladrado atornillador eléctrico



230V~50Hz	300 W
I: 0-550 min ⁻¹ II: 0-2100 min ⁻¹	20 Nm
	10 mm
	3.0m
21+1	

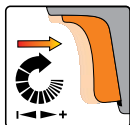

15



$L_{pA} = 66,0 \pm 3,0$ dB; $L_{wA} = 77,0 \pm 3,0$ dB; $a_n = 2,53 \pm 1,5 / 0,78 \pm 1,5$ m/s²

No.	W	min-1	
78990	300	0-550 / 0-2100	10

- PL Elektryczny klucz udarowy
- GB Electric impact wrench
- D Elektro-Schlagschrauber
- RUS Электрический гайковерт
- CZ Elektrický rázový uťahovák
- RO Cheie electrică
- H Elektromos ütvecsavarozó
- E llave de impacto eléctrica

230-240V-50Hz	1100 W	2200 min ⁻¹	450 Nm
1/2" 12.5 mm	17, 19 21, 22 mm	4m	



$L_{pA} = 89,0 \pm 3,0$ dB; $L_{wA} = 100,0 \pm 3,0$ dB; $a_n = 10,04 \pm 1,5$ m/s²

No.	W	min-1	
57092	1100	2200	2

- PL Zszywacz akumulatorowy
- GB Cordless staples gun
- D Akku-Tacker
- RUS Аккумуляторный степлер
- CZ Akumulátorová sponkovačka
- RO Capsatorul cu acumulator
- H Akkus tűzőgép
- E Grapadora a batería



3.6V	1.3 Ah
Li-Ion	30/min (max)
Micro USB	



$L_{pA} = 80,73 \pm 3,0$ dB; $L_{wA} = 91,73 \pm 3,0$ dB; $a_n = 2,628 \pm 1,5$ m/s²

No.	V	
78157	3.6	10

- PL Elektryczny klucz udarowy
- GB Electric impact wrench
- D Elektro-Schlagschrauber
- RUS Электрический гайковерт
- CZ Elektrický rázový uťahovák
- RO Cheie electrică
- H Elektromos ütvecsavarozó
- E llave de impacto eléctrica



230V~50Hz	800 W	2200 min ⁻¹	325 Nm
1/2" 12.5 mm	17, 19 21, 22 mm		



$L_{pA} = 87,5 \pm 3,0$ dB; $L_{wA} = 98,5 \pm 3,0$ dB; $a_n = 9,93 \pm 1,5$ m/s²

No.	W	min-1	
57091	800	2200	5

- PL Elektryczny klucz udarowy
- GB Electric impact wrench
- D Elektro-Schlagschrauber
- RUS Электрический гайковерт
- CZ Elektrický rázový uťahovák
- RO Cheie electrică
- H Elektromos ütvecsavarozó
- E llave de impacto eléctrica

230-240V-50Hz	1100 W	2200 min ⁻¹	800 Nm
3/4" 19 mm	24, 30 32, 36 mm	4m	



$L_{pA} = 89,0 \pm 3,0$ dB; $L_{wA} = 100,0 \pm 3,0$ dB; $a_n = 10,04 \pm 1,6$ m/s²

No.	W	min-1	
57097	1100	2200	2

- PL Szlifierka kątowa
- GB Angle grinder
- D Winkelschleifmaschine
- RUS Углошлифовальная машинка
- CZ Úhlová bruska
- RO Polizor unghiular
- H Sarokcsiszoló
- E Lijadera de angulo

230V~50Hz 600 W 11000min⁻¹

115mm M14



$L_{pa} = 73 \pm 3$ dB; $L_{wa} = 84 \pm 3$ dB; $a_h = 3,19 \pm 1,5$ m/s²



No.	W	min-1	
79094	600	11000	8

- PL Szlifierka kątowa
- GB Angle grinder
- D Winkelschleifmaschine
- RUS Углошлифовальная машинка
- CZ Úhlová bruska
- RO Polizor unghiular
- H Sarokcsiszoló
- E Lijadera de angulo

230V~50Hz 900 W 11000min⁻¹

125mm M14



$L_{pa} = 87 \pm 3$ dB; $L_{wa} = 98 \pm 3$ dB; $a_h = 4,62 \pm 1,5$ m/s²



No.	W	min-1	
79119	900	11000	8

- PL Szlifierka kątowa
- GB Angle grinder
- D Winkelschleifmaschine
- RUS Углошлифовальная машинка
- CZ Úhlová bruska
- RO Polizor unghiular
- H Sarokcsiszoló
- E Lijadera de angulo

230V~50Hz 2200 W 6500min⁻¹

230mm M14



$L_{pa} = 97 \pm 3$ dB; $L_{wa} = 108 \pm 3$ dB; $a_h = 7,33 \pm 1,5$ m/s²



No.	W	min-1	
79151	2200	6500	2

- PL Szlifierka kątowa
- GB Angle grinder
- D Winkelschleifmaschine
- RUS Углошлифовальная машинка
- CZ Úhlová bruska
- RO Polizor unghiular
- H Sarokcsiszoló
- E Lijadera de angulo

230V~50Hz 710 W 11000min⁻¹

125mm M14



$L_{pa} = 78 \pm 3$ dB; $L_{wa} = 89 \pm 3$ dB; $a_h = 3,84 \pm 1,5$ m/s²



No.	W	min-1	
79095	710	11000	8

- PL Szlifierka kątowa
- GB Angle grinder
- D Winkelschleifmaschine
- RUS Углошлифовальная машинка
- CZ Úhlová bruska
- RO Polizor unghiular
- H Sarokcsiszoló
- E Lijadera de angulo

230V~50Hz 1200 W 3000-11000min⁻¹

125mm M14



$L_{pa} = 88,0 \pm 3,0$ dB; $L_{wa} = 99,0 \pm 3,0$ dB; $a_h = 6,5 \pm 1,5$ m/s²



No.	W	min-1	
79124	1200	3000-11000	10

- PL Szlifierka na wysięgniku do ścian
- GB Drywall sander
- D Wandschleifmaschine mit Ausleger
- RUS Шлифовальная машина для стен
- CZ Bruska na stěny s ramenem
- RO Polizor cu brat pt. pereti
- H Hosszúszárú falcsiszoló
- E Pulidor para paredes en un brazo

230-240V~50Hz 600 W 600-1600min⁻¹ 225mm 6x

Ø 225 mm Ø 215 mm Ø 210 mm

GRIT / ZIARNISTOŚĆ: 60, 80, 100 120, 180, 240



$L_{pa} = 90,0 \pm 3,0$ dB; $L_{wa} = 101,0 \pm 3,0$ dB; $a_h = 3,86 \pm 1,5 / 3,51 \pm 1,5$ m/s²



No.	W	min-1	
79307	600	600-1600	2

- PL Wielofunkcyjne narzędzie oscylacyjne
- GB Multi-purpose oscillating tool
- D Multifunktionales Oszillationswerkzeug
- RUS Многофункциональный инструмент
- CZ Multifunkční oscilační nářadí
- RO Unealtă multifuncțională oscilantă
- H Multifunkciós rezgő szerszám
- E Herramienta oscilatoria multiusos

230V~50Hz 220 W

15000-23000 min⁻¹

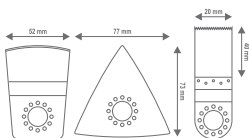

$L_{pa} = 89,4 \pm 3,0$ dB; $L_{wa} = 100,4 \pm 3,0$ dB; $a_n = 13,2 \pm 1,5$ m/s²

No.	W	min-1	
79240	220	15000-23000	10

- PL Szlifierka oscylacyjna
- GB Finishing sander
- D Bandschleifer
- RUS Виброшлифмашина
- CZ Oscilační bruska
- RO Polizor oscilant
- H Vibrációs csiszológép
- E Lijadora de oscilación

230V~50Hz 135 W

10000 min⁻¹



$L_{pa} = 84,0 \pm 3,0$ dB; $L_{wa} = 95,0 \pm 3,0$ dB; $a_n = 3,7 \pm 1,5$ m/s²

No.	W	min-1	
79491	135	10000	6

- PL Wyrzynarka
- GB Electric jig saw
- D Stichsäge
- RUS Лобзик электрический
- CZ Elektrická vyřezávací pila
- RO Fierastrau pendular
- H Elektromos dekopír fűrész
- E Cortadora electrica

230-240V-50Hz 500 W

0-3000min⁻¹

U-TYPE BLADE OSTRZE TYP-U

2.5m



$L_{pa} = 87,4 \pm 3,0$ dB; $L_{wa} = 98,4 \pm 3,0$ dB; $a_n = 6,4 \pm 1,5 / 6,9 \pm 1,5$ m/s²

No.	W	min-1	
79473	500	0-3000	10

- PL Szlifierka mimośrodowa
- GB Orbital sander
- D Exzentrische Schleifmaschine
- RUS Эксцентриковая шлифовальная машина
- CZ Excentrická bruska
- RO Polizor cu excentric
- H Excenter csiszoló
- E Pulidor excentrico

230V~50Hz 430 W

6000-13000 min⁻¹

∅125mm



$L_{pa} = 81,0 \pm 3,0$ dB; $L_{wa} = 92,0 \pm 3,0$ dB; $a_n = 10,8 \pm 1,5$ m/s²

No.	W	min-1	
79309	430	6000-13000	6

- PL Szlifierka taśmowa
- GB Belt sander
- D Bandschleifer
- RUS Ленточная шлифмашина
- CZ Pásová bruska
- RO Sac rumegus
- H Szalagcsiszológép
- E Maquina de pulir de banda

230V~50Hz 950 W

200-380 min⁻¹

533x76mm



$L_{pa} = 85,6 \pm 3,0$ dB; $L_{wa} = 96,6 \pm 3,0$ dB; $a_n = 3,73 \pm 1,5$ m/s²

No.	W	m/min	
79420	950	200-380	4

- PL Wyrzynarka
- GB Electric jig saw
- D Stichsäge
- RUS Лобзик электрический
- CZ Elektrická vyřezávací pila
- RO Fierastrau pendular
- H Elektromos dekopír fűrész
- E Cortadora electrica

230-240V-50Hz 650 W

0-3000min⁻¹

T-TYPE BLADE OSTRZE TYP-T

2.5m



$L_{pa} = 87,4 \pm 3,0$ dB; $L_{wa} = 98,4 \pm 3,0$ dB; $a_n = 6,4 \pm 1,5 / 6,9 \pm 1,5$ m/s²

No.	W	min-1	
79474	650	0-3000	8

PL Wyrzynarka
GB Electric jig saw
D Stichsäge
RUS Лобзик электрический
CZ Elektrická vyřezávací pila
RO Fierastrau pendular
H Elektromos dekopír fűrész
E Cortadora electrica

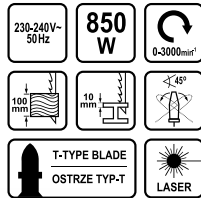

$L_{pA} = 87,4 \pm 3,0$ dB; $L_{wA} = 98,4 \pm 3,0$ dB; $a_n = 6,4 \pm 1,5 / 6,9 \pm 1,5$ m/s²; Laser: 650 Nm; ≤ 1 m/s²

No.	W	min-1	Icon
79476	850	0-3000	8

PL Pilarka ręczna
GB Circular saw
D Handkreissäge
RUS Дисковая пила
CZ Pila kotoučová
RO Fierastrau circular
H Kézi körfűrészgép
E Sierra de disco



$L_{pA} = 94,0 \pm 3,0$ dB; $L_{wA} = 105,0 \pm 3,0$ dB; $a_n = 6,84 \pm 1,5$ m/s²

No.	W	min-1	Icon
79257	1400	4800	4

PL Opalarka
GB Hot air gun
D Heissluftpistole
RUS Фен технический

CZ Opalovací stroj
RO Pistol aer cald
H Hőlégfúvó tartozékokkali
E Secadora

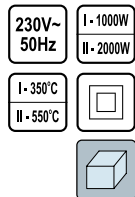

No.	W	°C	Icon
79320	1000-2000	350-550	10

PL Pilarka ręczna
GB Circular saw
D Handkreissäge
RUS Дисковая пила
CZ Pila kotoučová
RO Fierastrau circular
H Kézi körfűrészgép
E Sierra de disco

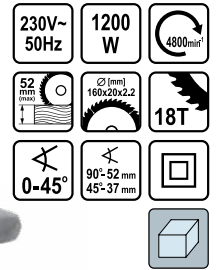

$L_{pA} = 94,0 \pm 3,0$ dB; $L_{wA} = 105,0 \pm 3,0$ dB; $a_n = 6,84 \pm 1,5$ m/s²

No.	W	min-1	Icon
79254	1200	4800	4

PL Strug elektryczny
GB Electric planer
D Elektrohobel
RUS Электрорубанок
CZ Elektrický hoblík
RO Rindea electrica
H Elektromos gyalu
E Garlopa electrica

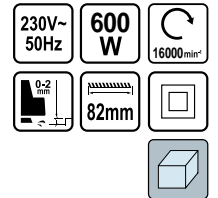

$L_{pA} = 83,0 \pm 3,0$ dB; $L_{wA} = 94,0 \pm 3,0$ dB; $a_n = 6,55 \pm 1,5$ m/s²

No.	W	min-1	Icon
79416	600	16000	6

PL Opalarka
GB Hot air gun
D Heissluftpistole
RUS Фен технический

CZ Opalovací stroj
RO Pistol aer cald
H Hőlégfúvó tartozékokkali
E Secadora

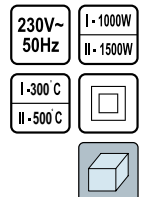

No.	W	°C	Icon
79327	1000-1500	300-500	10

PL Opalarka z akcesoriami CZ Opalovací stroj w s příslušenstvím
 GB Hot air gun with accessories RO Fion cu accesorii pt. ars vopseaua
 D Heissluftpistole H Hőlégfűvő tartozékokkal
 RUS Фен технический в наборе E Secadora con accesorios

230V~
50Hz

I-300 C
II-500 C

I-1000W
II-1500W



STHOR

No.	W	°C	
79328	1000-1500	300-500	5

PL Pistolet do klejenia CZ Pistole na lepení
 GB Electric glue gun RO Pistol pt. lipit
 D Heissklebepistole H Ragasztópisztoly
 RUS Пистолет для клея E Pistola de cola

230V~
50Hz

200 °C

3-5 min

8-12 g/min

15(40) W

2x
∅11mm



STHOR

No.	W	diameter of glue stick / średnica wkładu (mm)	capacity / wydajność (g / min)	
73056	15 (40)	11	12	6/48

PL Pistolet do klejenia CZ Pistole na lepení
 GB Electric glue gun RO Pistol pt. lipit
 D Heissklebepistole H Ragasztópisztoly
 RUS Пистолет для клея E Pistola de cola

230V~
50Hz

23(80) W

14-16 g/min

3-5 min

200 °C

2x
∅11mm



STHOR

No.	W	diameter of glue stick / średnica wkładu (mm)	capacity / wydajność (g / min)	
73057	23 (80)	11	15	6/48

PL Dmuchawa CZ Výtačný ventilátor
 GB Blower RO Suflantă
 D Gebläse H Légfűvő
 RUS Сетевой вентилятор E Soplador

220-240V~
50/60Hz

3.3 m³/min

400 W

2m

SUCTION FUNCTION
FUNKCJA ZASYSANIA

BLOW FUNCTION
FUNKCJA DMUCHAWY



STHOR

$L_{pA} = 82.1 \pm 2.5$ dB; $L_{wA} = 95.0 \pm 2.5$ dB; $a_s = 2.994 \pm 1.5$ m/s²

No.	W	
79662	400	4

PL Pistolet do klejenia CZ Pistole na lepení
 GB Electric glue gun RO Pistol pt. lipit
 D Heissklebepistole H Ragasztópisztoly
 RUS Пистолет для клея E Pistola de cola

230V~
50Hz

180-200 °C

3-6 min

15 g/min

15(100) W

2x
∅11mm



STHOR

No.	W	diameter of glue stick / średnica wkładu (mm)	capacity / wydajność (g / min)	
73052	15 (100)	11	16	12/48

PL Odkurzacz przemysłowy GB Industrial vacuum cleaner
 D Industriesauger
 RUS Пылесос промышленный
 CZ Průmyslový vysavač
 RO Aspirator industrial
 H Ipari porszívó
 E Aspirador industrial

220-240V~
50/60Hz

15l

IPX4

1000 W

18 kPa



STHOR

No.	W	
78872	1000	1

PL Odkurzacz przemysłowy
GB Industrial vacuum cleaner
D Industriesauger
RUS Пылесос промышленный
CZ Průmyslový vysavač
RO Aspirator industrial
H Ipari porszívó
E Aspirador industrial



220-240V~
50/60Hz

1200 W

20l

18 kPa

IPX4

STHOR

No.	W	
78874	1200	1

PL Lutownica oporowa
GB Soldering iron
D DelötKolben
RUS Электродпаяльник

CZ Pájka odporová
RO Ciocan de lipit
H Huforrasztópáka
E Soldador de resistencia

230V~
50Hz

400°C



STHOR

No.	W	
79393	30	25/50
79394	60	25/50
79396	80	25/50
79397	100	25/50

PL Stacja lutownicza
GB Soldering station
D Lötstation
RUS Паяльная станция

CZ Letovací stanice
RO Stație de lipit
H Forrasztópáka állomás
E Estación de soldadura

230V~
50Hz

40 W

150÷420
°C

∅
4,7 mm



STHOR

No.	W	
79376	40	12

PL Lutownica oporowa
GB Soldering iron
D DelötKolben
RUS Электродпаяльник

CZ Pájka odporová
RO Ciocan de lipit
H Huforrasztópáka
E Soldador de resistencia

230V~
50Hz

400°C

5-10 min



STHOR

No.	W	
79365	30	25/50
79366	40	25/50
79367	60	25/50
79368	80	25/50

PL Komplet grotów do stacji lutowniczej
GB Spare soldering tips
D Lötspitze
RUS Наконечник паяльника

CZ Hrot do letovačky
RO Vârf pt. ciocanul de lipit
H Pákahegy
E Pico soldador

3 pcs

∅4,7 mm
56,5 mm

40 W

420 °C

for/dla:
79376



STHOR

No.	W	pcs	R	for / dla	
79377	40	3	0.4; 0.8; 1.2	79376	600
79378	40	3	1.6; 1.6; 3.2	79376	600

PL Lutownica transformatorowa
GB Transformer soldering gun
D Lötpestole
RUS Паяльник электрический

CZ Transformátorová páječka
RO Pistol de lipit + accesorii
H Forrasztópáka
E Soldador transformador

230V~
50Hz

100 W



STHOR

No.	W	
79354	100	10

PL Lutownica transformatorowa CZ Transformátorová páječka
 GB Transformer soldering gun RO Pistol de lipit + accesorii
 D Lötspistole H Forrasztópáka
 RUS Паяльник электрический E Soldador transformador

230V~50Hz 100 W 650°C



No.	W	
79364	100	10

PL Szlifierka stolowa CZ Stolní bruska
 GB Bench grinder RO Polizor de banc
 D Doppelschleifmaschine H Aszatti köszörű
 RUS Станок точильный E Lijadera de mesa

230V~50Hz 120 W 2950 min⁻¹



$L_{pa} = 63,0 \pm 3,0$ dB; $L_{wa} = 76,0 \pm 3,0$ dB

No.	W	min-1	
79205	120	2950	1

PL Szlifierka stolowa CZ Stolní bruska
 GB Bench grinder RO Polizor de banc
 D Doppelschleifmaschine H Aszatti köszörű
 RUS Станок точильный E Lijadera de mesa

230V~50Hz 350 W 2950 min⁻¹



$L_{pa} = 63,0 \pm 3,0$ dB; $L_{wa} = 76,0 \pm 3,0$ dB

No.	W	min-1	
79207	350	2950	1

PL Mieszarka do zapraw GB Hand mixer
 D Mörtelmischgerät RUS Растворомешалка
 CZ Ruční míchačka na maltu
 RO Malaxor pt. mortar H Habarcskeverő
 E Mezcladora de mortero

220-240V~50/60Hz 1200 W 0-680 min⁻¹ 120 mm

80l M14

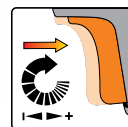

$L_{pa} = 92 \pm 3$ dB; $L_{wa} = 103 \pm 3$ dB; $a_n = 2,874 \pm 1,5$ m/s²

No.	W	min-1	
78854	1200	0 - 680	2

PL Szlifierka stolowa CZ Stolní bruska
 GB Bench grinder RO Polizor de banc
 D Doppelschleifmaschine H Aszatti köszörű
 RUS Станок точильный E Lijadera de mesa

230V~50Hz 150 W 2950 min⁻¹



$L_{pa} = 63,0 \pm 3,0$ dB; $L_{wa} = 76,0 \pm 3,0$ dB

No.	W	min-1	
79206	150	2950	1

PL Zgrzewarka do rur termoplastycznych GB PVC plastic pipe welder
 D Schweissgerät für thermoplastische Rohre RUS Сварочная машина для термопластиковых труб
 CZ Svářečka na termoplastické trubky RO Hegesztő berendezés termoplasztikus csövekhez
 H Masina de sudat tevi termoplastice E Maquina de soldar las tubos termoplasticos

230V~50Hz I-1750W II-1500W

0-300 °C IPX0

∅ 20, 25, 32 [mm] 40, 50, 63



No.	W	
78912	750-1500	4

- PL Zgrzewarka do rur termoplastycznych
- GB PVC plastic pipe welder
- D Schweissgerät für thermoplastische Rohre
- RUS Сварочная машина для термопластиковых труб
- CZ Svářečka na termoplastické trubky
- RO Hegeştoó berendezés termoplasztikus csövekhez
- H Masina de sudat tevi termoplastice
- E Maquina de soldar los tubos termoplasticos

230V~ 50Hz	800 W	1500 W
0-300 °C	16, 20, 25, 32 40, 50, 63 [mm]	IP24



STHOR

No.	W	
78910	800-1500	5

- PL Pompa zatapialna do wody brudnej
- GB Dirty water submersible pump
- D Tauchmotorpumpe
- RUS Погружной насос
- CZ Zataovací čerpadlo
- RO Pompă pt. apă murdară
- H Búvárszivattyú
- E Bomba de inmersión para agua sucia

230V~ 50Hz	1" 25mm	5/4" 32mm	1.5" 38mm
---------------	------------	--------------	--------------



STHOR

No.	W	l/h	H (max)	
79781	400	8000	5.5	4
79782	500	10000	6.5	4
79783	600	11500	7.0	4

- PL Pompa zatapialna do wody brudnej
- GB Dirty water submersible pump
- D Tauchmotorpumpe
- RUS Погружной насос
- CZ Zataovací čerpadlo
- RO Pompă pt. apă murdară
- H Búvárszivattyú
- E Bomba de inmersión para agua sucia

230V~ 50Hz	400 W	Q max 6000 l/h	H max 6 m
	1" 25mm	5/4" 32mm	1.5" 38mm



STHOR

No.	W	l/h	H (max)	
79909	400	6000	6	6

- PL Pompa membranowa zatapialna
- GB Membrane deep well water pump
- D Tauchmotorpumpe
- RUS Погружной насос
- CZ Zataovací čerpadlo
- RO Pompă pt. apă cu membrana
- H Búvárszivattyú
- E Bomba de diafragma sumergible

220-230V~ 50Hz	Q max 1020 l/h
-------------------	-------------------

280 W	H max 68 m
----------	---------------



STHOR

No.	W	l/h	H max (m)	
79943	280	1020	68	4

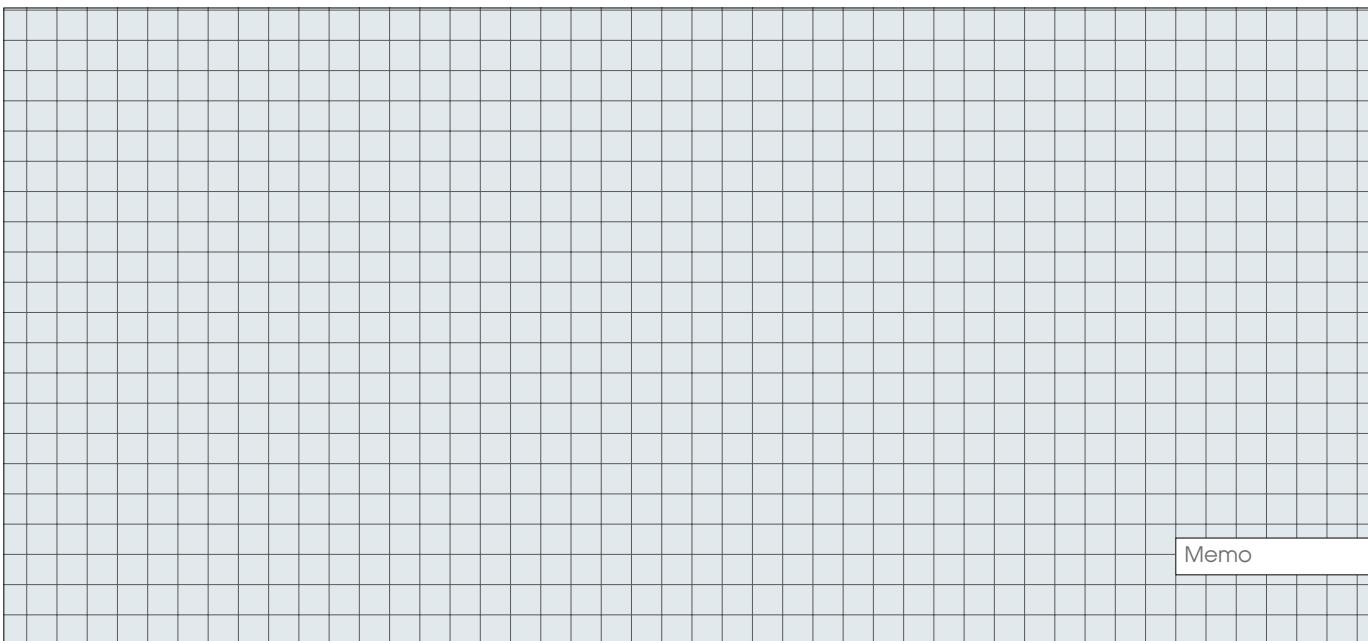

- PL Młot udarowy
- GB Rotary hammer
- D Bohrhämmer
- RUS Перфоратор
- CZ Přerážecí kladivo
- RO Ciocan percutatnt
- H Fúrókalapács-gép
- E Martillo de percusión

230V~50Hz
1050 W
900 min⁻¹
T 4000 min⁻¹
4.5 J
SDS PLUS

4mm
13mm
26mm



LUND

$L_{pa} = 92,3 \pm 3,0$ dB; $L_{wa} = 103,3 \pm 3,0$ dB; $a_n = 12,730 \pm 1,5$ m/s²

No.	W	min-1	
79046	1050	900	2

- PL Uniwersalna szlifierka wielofunkcyjna
- GB Mini grinder
- D Universal-Mehrweckschleifmaschine
- RUS Универсальная шлифовальная машина
- CZ Víceúčelová univerzální bruska
- RO Mașina de șlefuit universală multifuncțională
- H Univerzális daugiafunkcis sírfuoklis
- E Lijadora multifunción

230V~50Hz
135 W
40 pcs

10000-35000 min⁻¹
2,3, 3,2 10 mm



LUND

$L_{pa} = 72,0 \pm 3,0$ dB; $L_{wa} = 83,0 \pm 3,0$ dB; $a_n = 2,60 \pm 1,5$ m/s²

No.	W	min-1	
79314	135	10000-35000	10

- PL Szlifierka oscylacyjna
- GB Finishing sander
- D Schwingschleifer
- RUS Виброшлифмашина
- CZ Oscilační bruska
- RO Polizor oscilant
- H Vibrációs csiszológép
- E Lijadora de oscilación

230V~50Hz
135 W
11000 min⁻¹

240 mm



LUND

$L_{pa} = 79,7 \pm 3,0$ dB; $L_{wa} = 90,7 \pm 3,0$ dB; $a_n = 6,140 \pm 1,5 / 7,629 \pm 1,5$ m/s²

No.	W	min-1	
79493	135	11000	10

- PL Nóż termiczny do styropianu
- GB Thermal knife for polystyrene foam
- D Thermomesser für Styropor
- RUS Термонож для пенопласта
- CZ Termický nůž na pěnový polystyrén
- RO Cuțit termic pt. stiropian
- H Polisztirol vágó hőkés
- E Cuchilla térmica para poliestireno

9W
6V...
POLYSTYRENE STYROPIAN



INTERCHANGEABLE TIPS: 3 pcs
 - WIRE 17 cm
 - HOT KNIFE 12 cm
 - ENGRAVING TOOL 3.5 cm
 - BASE
 - ADDITIONAL CUTTING WIRE 1 pc

KONCÓWKI WYMIENNE: 3 szt.
 - DRUT 17 cm
 - NÓŻ DO CIĘCIA NA GORĄCO 12 cm
 - NASADKA DO GRAWEROWANIA 3,5 cm
 - PODSTAWKA
 - ZAPASOWY DRUT TNĄCY 1 szt.

LUND

No.	W	
78894	9	20

- PL Szlifierka kątowa
- GB Angle grinder
- D Winkelschleifmaschine
- RUS Углошлифовальная машинка
- CZ Úhlová bruska
- RO Polizor unghiular
- H Sarokcsiszoló
- E Lijadora de angulo

230V~50Hz
500 W
12000 min⁻¹

125 mm
M14



LUND

$L_{pa} = 88,0 \pm 3,0$ dB; $L_{wa} = 99,0 \pm 3,0$ dB; $a_n = 6,92 \pm 1,5$ m/s²

No.	W	min-1	
79125	500	12000	10

- PL Polerka samochodowa
- GB Car polisher
- D Autopoliermaschine
- RUS Полировальная машинка
- CZ Leštička na automobile
- RO Masina de lustruit automobile
- H Gépkocsi polírozógép
- E Maquina para pulir coches

230V~50Hz
120 W
3200 min⁻¹

240 mm



LUND

$L_{pa} = 55,0 \pm 3,0$ dB; $L_{wa} = 66,0 \pm 3,0$ dB; $a_n = 14,8 \pm 1,5$ m/s²

No.	W	min-1	
82942	120	3200	6

PL Strug elektryczny
GB Electric planer
D Elektrohebel
RUS Электрорубанок
CZ Elektrický hoblík
RO Rindea electrica
H Elektromos gyalu
E Garlopa electrica

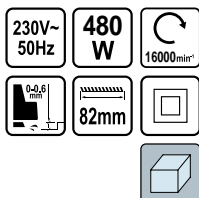

LUND

$L_{pA} = 83,0 \pm 3,0$ dB; $L_{wA} = 95,0 \pm 3,0$ dB; $a_n = 6,63 \pm 1,5$ m/s²

No.	W	min-1	
79415	480	16000	8

PL Opalarka z akcesoriami
GB Hot air gun with accessories
D Heissluftpistole
RUS Фен технический в наборе

CZ Opalovací stroj w s příslušenstvím
RO Fion cu accesorii pt. ars vopseaua
H Hőlégfúvó tartozékokkal
E Secadora con accesorios

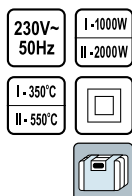

LUND

No.	W	°C	
79325	1000-2000	350-550	10

PL Pistolet do klejenia
GB Electric glue gun
D Heissklebepistole
RUS Пистолет для клея

CZ Pistole na lepení
RO Pistol pt. lipit
H Ragasztópisztoly
E Pistola de cola

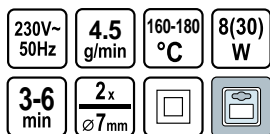

LUND

No.	W	diameter of glue stick / średnica wkładu (mm)	capacity / wydajność (g / min)	
73040	8 (30)	7	4.5	12/48

PL Opalarka
GB Hot air gun
D Heissluftpistole
RUS Фен технический

CZ Opalovací stroj
RO Pistol aer cald
H Hőlégfúvó tartozékokkal
E Secadora

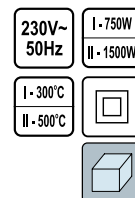

LUND

No.	W	°C	
79324	750-1500	300-500	10

PL Opalarka z akcesoriami
GB Hot air gun with accessories
D Heissluftpistole
RUS Фен технический в наборе

CZ Opalovací stroj w s příslušenstvím
RO Fion cu accesorii pt. ars vopseaua
H Hőlégfúvó tartozékokkal
E Secadora con accesorios

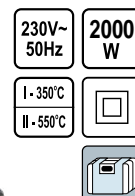

LUND

No.	W	°C	
79318	1000-2000	350-550	10

PL Pistolet do klejenia
GB Electric glue gun
D Heissklebepistole
RUS Пистолет для клея

CZ Pistole na lepení
RO Pistol pt. lipit
H Ragasztópisztoly
E Pistola de cola

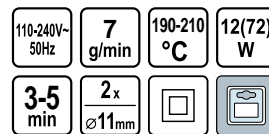

LUND

No.	W	diameter of glue stick / średnica wkładu (mm)	capacity / wydajność (g / min)	
73051	12 (72)	11	7	12/48

PL Pistolet do klejenia
GB Electric glue gun
D Heissklebepistole
RUS Пистолет для клея

CZ Pistole na lepeni
RO Pistol pt. lipit
H Ragasztópisztoly
E Pistola de cola

230V~50Hz 11 g/min 200 °C 16W

3-5 min ∅11 mm



LUND

No.	W	diameter of glue stick / średnica wkładu (mm)	capacity / wydajność (g / min)	☐
73060	16	11	11	10

PL Lutownica oporowa
GB Soldering iron
D Delötkolben
RUS Электропаяльник

CZ Pájka odporová
RO Ciocan de lipit
H Huforrasztópáka
E Soldador de resistencia

230V~50Hz 100 W 400°C

5-10 min ∅8 mm



PL Lutownica oporowa
GB Soldering iron
D Delötkolben
RUS Электропаяльник

CZ Pájka odporová
RO Ciocan de lipit
H Huforrasztópáka
E Soldador de resistencia

230V~50Hz 400°C

5-10 min



LUND

No.	W	∅ (mm)	☐
79382	40	5	25/50
79383	60	6	25/50

PL Stacja lutownicza
GB Soldering station
D Lötstation
RUS Паяльная станция

CZ Letovací stanice
RO Stație de lipit
H Forrasztópáka állomás
E Estación de soldadura

230V~50Hz 40 W 150 + 420 °C

2x ∅3.8mm



15

LUND

No.	W	∅ (mm)	☐
79385	100	8	25/50

PL Lutownica transformatorowa
GB Transformer soldering gun
D Lötpestole
RUS Паяльник электрический

CZ Transformátorová páječka
RO Pistol de lipit + accesorii
H Forrasztópáka
E Soldador transformador

230V~50Hz 100 W

☑ ☐ ☐



LUND

No.	W	☐
79373	40	20

PL Lutownica transformatorowa
GB Transformer soldering gun
D Lötpestole
RUS Паяльник электрический

CZ Transformátorová páječka
RO Pistol de lipit + accesorii
H Forrasztópáka
E Soldador transformador

230V~50Hz 100 W 650°C

☑ ☐ ☐



LUND

No.	W	☐
79355	100	10

LUND

No.	W	☐
79363	100	10

- PL Lutownica i pirograf do drewna
- GB Wood burning kit
- D Holzofen Kit
- RUS Пирографии набор
- CZ Souprava pro spalování dřeva
- RO Set pirogravură
- H Pirográf készülék
- E Pirograbado de madera kit

230V~ 50Hz	400°C
30W	



LUND

No.	W	
78890	30	15

- PL Zgrzewarka do rur termoplastycznych
- GB PVC plastic pipe welder
- D Schweissgerät für thermoplastische Rohre
- RUS Сварочная машина для термопластиковых труб
- CZ Svářečka na termoplastické trubky
- RO Hegesztő berendezés termoplasztikus csövekhez
- H Masina de sudat tevi termoplastice
- E Máquina de soldar las tubos termoplásticos

230V~ 50Hz	800 W
0-300 °C	IPX4
∅ 16, 20, 25 [mm] 32, 40, 50	



LUND

No.	W	
78911	800	5

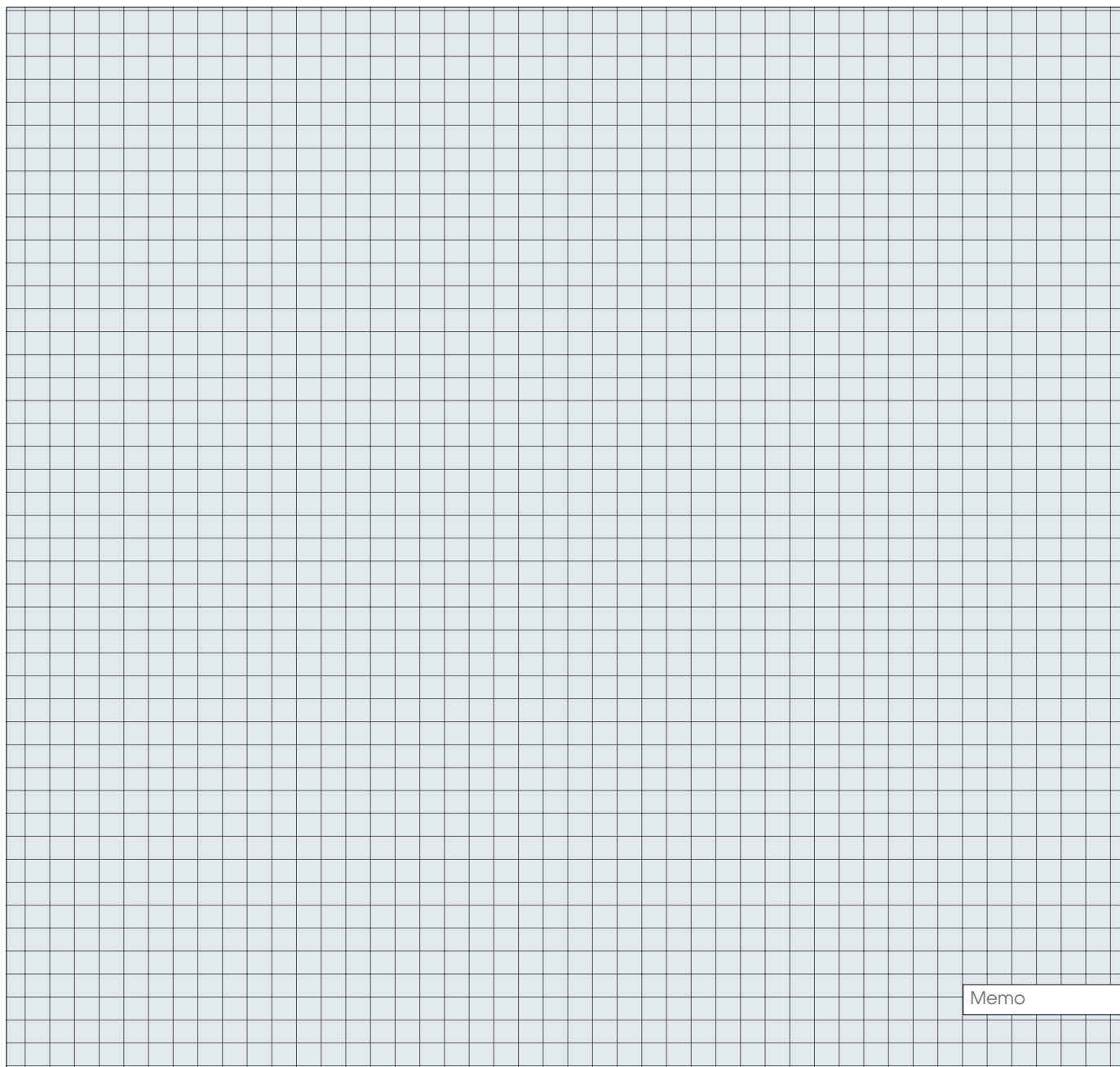

- PL Akumulatorowe nożyce do trawy i krzewów
- GB Cordless grass and shrub shears
- D Akkuscherer mit Gras- und Strauchmesser
- RUS Аккумуляторные ножницы для травы и кустов
- CZ Akumulátorové nůžky na trávu a keře
- RO Trimmer cu acumulator pt. iarba si gard viu
- H Foarfecele cu acumulator pt. tăiat iarba
- E Tijeras a batería para hierba y arbustos

3.6 V
1.3 Ah
Li-Ion

1000 min⁻¹

Li-Ion

80 mm

2in1

110 mm



$L_{pa} = 74,6 \pm 3,0$ dB; $L_{wa} = 86,4 \pm 3,0$ dB; $a_n = 1,63 \pm 1,5$ m/s²

No.	min-1	
79500	1000	8

- PL Akumulatorowa podkaszarka do trawy
- GB Cordless grass trimmer
- D Akku-Rasentrimmer
- RUS Аккумуляторные триммеры
- CZ Akumulátorová sekačka na trávu
- RO Trimmere de gazon cu acumulator
- H Akkus szegélynyíró
- E Desmalezadora inalámbrica

18 V

1.5 Ah

27 Wh

8000 min⁻¹

Li-Ion

230 mm

TAP&GO SPOOL HEAD TYPE
GŁOWIĆCA TYPU TAP&GO

CHARGE LEVEL INDICATOR
WSKAZNIK STANU NAŁADOWANIA BATERII



$L_{pa} = 72,4 \pm 3,0$ dB; $L_{wa} = 87,37 \pm 3,0$ dB; $a_n = 1,45 \pm 1,5$ m/s²

No.	V	min-1	Ø (mm)	
79510	18	8000	230	2

- PL Akumulator
- GB Battery
- D Akkumulator
- RUS Аккумулятор
- CZ Akumulátor
- RO Acumulatorul
- H Akkumulátor
- E Acumulador

18 V

1.5 Ah

27 Wh

Li-Ion

CHARGE LEVEL INDICATOR
WSKAZNIK STANU NAŁADOWANIA BATERII

for/dla: 79510 79520



No.	V	for / dla	
79530	18	79510; 79520	25

- PL Akumulatorowe nożyce do trawy i krzewów
- GB Cordless grass and shrub shears
- D Akkuscherer mit Gras- und Strauchmesser
- RUS Аккумуляторные ножницы для травы и кустов
- CZ Akumulátorové nůžky na trávu a keře
- RO Trimmer cu acumulator pt. iarba si gard viu
- H Foarfecele cu acumulator pt. tăiat iarba
- E Tijeras a batería para hierba y arbustos

3.6 V
1.3 Ah
Li-Ion

1000 min⁻¹

Li-Ion

80 mm

2in1

110 mm



$L_{pa} = 74,6 \pm 3,0$ dB; $L_{wa} = 86,4 \pm 3,0$ dB; $a_n = 1,63 \pm 1,5$ m/s²

No.	min-1	
79501	1000	8

- PL Akumulatorowe nożyce do żywoplotu
- GB Cordless hedge trimmer
- D Akku-Heckenschere
- RUS Аккумуляторный кусторез
- CZ Akumulátorové nůžky na živé ploty
- RO Akkus sövénynyíró
- H Foarfecele de tăiat gard viu cu acumulator
- E Cortasetos inalámbrico

18 V

1.5 Ah

27 Wh

1100 min⁻¹

Li-Ion

440mm

CHARGE LEVEL INDICATOR
WSKAZNIK STANU NAŁADOWANIA BATERII



$L_{pa} = 75,19 \pm 3,0$ dB; $L_{wa} = 86,19 \pm 3,0$ dB; $a_n = 0,933 \pm 1,5$ m/s²

No.	V	min-1	L (mm)	
79520	18	1100	440	2

- PL Pompa zatapialna do wody brudnej
- GB Dirty water submersible pump
- D Tauchmotorpumpe
- RUS Погружной насос
- CZ Zatavovací čerpadlo
- RO Pompă pt. apă murdară
- H Búvárszivattyú
- E Bomba de inmersión para agua sucia

230V~50Hz

1" 25mm

5/4" 32mm

1.5" 38mm



No.	W	l / h	H (max)	
79771	400	10000	6.5	4
79772	550	11500	7.0	4
79773	750	14000	7.5	4
79774	900	16000	8.5	4
79775	1100	16000	8.5	4

- PL Pompa zatapialna do wody brudnej
 GB Dirty water submersible pump
 D Tauchmotorpumpe
 RUS Погружной насос
 CZ Zátavovací čerpadlo
 RO Pompă pt. apă murdară
 H Bűvárszivattyú
 E Bomba de inmersión para agua sucia



No.	W	l / h	H (max)	
79790	750	14000	7.5	2
79791	900	16000	8.5	2
79792	1100	20000	9.0	2

- PL Pompa zatapialna do wody brudnej i ścieków
 GB Submersible pump for dirty water and wastewater
 D Tauchpumpe für Schmutzwasser
 RUS Погружной насос для грязной воды
 CZ Ponomé čerpadlo pro odpadní vody
 RO Pompă submersibilă pt. apă uzată
 H Bűvárszivattyú szennyvíz
 E Bomba sumergible para aguas residuales



No.	W	l / h	H (max)	
79880	450	16000	9	1

- PL Pompa fontanna
 GB Fountain pump
 D Springbrunnenpumpe
 RUS Фонтанный насос
 CZ Fontánová pumpa
 RO Pompă pt. fantana arteziana
 H Pumpa szökőkúthoz
 E Bomba para las fuentes



No.	W	l / h	H (max)	
79926	8	600	1.0	12
79927	16	800	1.3	12
79928	22	1000	1.6	12

- PL Pompa membranowa zatapialna
 GB Membrane deep well water pump
 D Tauchmotorpumpe
 RUS Погружной насос
 CZ Zátavovací čerpadlo
 RO Pompă pt. apă cu membrană
 H Bűvárszivattyú
 E Bomba de diafragma sumergible

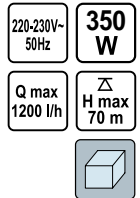

No.	W	l / h	H max (m)	
79944	350	1200	70	4

- PL Pompa ogrodowa
 GB Jet pump
 D Gartenpumpe
 RUS Насос садовый
 CZ Zahradní čerpadlo
 RO Pompă apă
 H Kerti szivattyúhoz
 E Bomba de jardín con cabeza

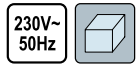
 $L_{wA} = 95 \pm 3 \text{ dB}$

No.	W	l / h	H (max)	max. pressure / max. ciśnienie (bar)	
79810	600	2800	35	3.5	1
79811	800	3600	40	4.0	1
79812	1000	3800	44	4.4	1



- PL Pompa fontannowa
- GB Fountain pump
- D Springbrunnenpumpe
- RUS Фонтанный насос
- CZ Fontánová pumpa
- RO Pompa pt. fantana arteziana
- H Pumpa szökőkúthoz
- E Bomba para las fuentes



230V~
50Hz

5
NOZZLES
DYSZE

IPX8



No.	W	l / h	H (max)	
79929	28	1400	2.0	8
79930	40	1800	2.5	8

- PL Podkaszarka elektryczna
- GB Electric trimmer
- D Elektro-Rasentrimmer
- RUS Электрический триммер
- CZ Elektrická sekačka
- RO Cositoare electrică
- H Elektromos fűnyíró
- E Segadora eléctrica



230V~
50Hz

500
W

10500
min⁻¹

280 mm

↑100 cm
↓80 cm

2
POSITIONS
POZYCJE



$L_{pA} = 74.4 \pm 1.94$ dB; $L_{wA} = 94.1 \pm 1.94$ dB; $a_n = 0.794 \pm 1.5$ m/s²

No.	W	min-1	Ø (mm)	
79467	500	10500	280	4

- PL Nożyce do żywoplotu
- GB Hedge shears
- D Heckenscheren
- RUS Ножницы для живой изгороди
- CZ Nůžky na živý plot
- RO Foarfece pt. gard viu
- H Sövénývágó olló
- E Tijera para vallado



No.	W	min-1	L (mm)	
79444	520	1600	510	4

- PL Pompa fontannowa
- GB Fountain pump
- D Springbrunnenpumpe
- RUS Фонтанный насос
- CZ Fontánová pumpa
- RO Pompa pt. fantana arteziana
- H Pumpa szökőkúthoz
- E Bomba para las fuentes



230V~
50Hz

5
NOZZLES
DYSZE

IP68

CABLE
10m



No.	W	l / h	H (max)	
79931	55	2000	2.5	8
79932	85	3000	3.5	8
79933	100	4500	4.5	6

- PL Elektryczne nożyce do żywoplotu
- GB Hedge shears
- D Heckenscheren
- RUS Ножницы для живой изгороди
- CZ Nůžky na živý plot
- RO Foarfece pt. gard viu
- H Sövénývágó olló
- E Tijera para vallado

230V~
50Hz

450
W

1700min⁻¹

410mm



$L_{pA} = 81.6 \pm 3.0$ dB; $L_{wA} = 101.6 \pm 3.0$ dB; $a_n = 5.328 \pm 1.5 / 6.1214 \pm 1.5$ m/s²

No.	W	min-1	L (mm)	
79442	450	1700	410	4

230V~
50Hz

520
W

1600min⁻¹

510mm



$L_{pA} = 75.2 \pm 0.6$ dB; $L_{wA} = 95.2 \pm 0.6$ dB; $a_n = 2.840 \pm 1.5$ m/s²

- PL Nożyce do żywoplotu
- GB Hedge shears
- D Heckenscheren
- RUS Ножницы для живой изгороди
- CZ Nůžky na živý plot
- RO Foarfece pt. gard viu
- H Sövényágó olló
- E Tijera para vallado



No.	W	min-1	L (mm)	
79448	550	1700	510	4

$L_{pA} = 78,58 \pm 1,489$ dB; $L_{wA} = 98,54 \pm 1,489$ dB; $a_b = 3,272 \pm 1,5 / 3,435 \pm 1,5$ m/s²



Memo

PL Lutownica pistoletowa CZ Pájka odporová
 GB Soldering iron RO Ciocan de lipit
 D Delötkolben H Huforrasztópáka
 RUS Электропаяльник E Soldador de resistencia



No.	W	
79358	40	25/50

PL Lutownica transformatorowa CZ Transformátorová páječka
 GB Transformer soldering gun RO Pistol de lipit
 D Lötpestole H Forrasztópáka
 RUS Паяльник электрический E Soldador transformador

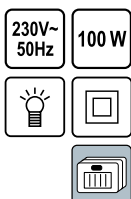

No.	W	
79350	100	24

PL Glowica żyłkowa GB Line head
 D Trimmerkopf
 RUS Головка с леской
 CZ Strunová hlava
 RO Cap cu cablu
 H Damil fej
 E Cabezal de hilo

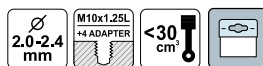

No.	Ø (mm)	
79550	2.0-2.4	10/40

PL Glowica żyłkowa GB Line head
 D Trimmerkopf
 RUS Головка с леской
 CZ Strunová hlava
 RO Cap cu cablu
 H Damil fej
 E Cabezal de hilo

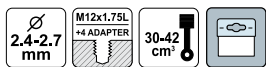

PL Glowica żyłkowa GB Line head
 D Trimmerkopf
 RUS Головка с леской
 CZ Strunová hlava
 RO Cap cu cablu
 H Damil fej
 E Cabezal de hilo

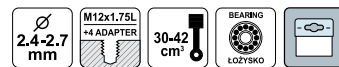

No.	Ø (mm)	
79552	2.4-2.7	10/40



No.	Ø (mm)	
79551	2.4-2.7	10/40

PL Głowica żyłkowa
GB Line head
D Trimmerkopf
RUS Головка с леской
CZ Strunová hlava
RO Cap cu cablu
H Damil fej
E Cabezal de hilo

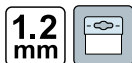

No.	Ø (mm)	for / dla	☐
79468	1.2	79467	20/100

PL Żyłka tnąca
GB Grass trimmer line
D Mähfaden
RUS Леска для триммера
CZ Struna do strunové sekačky
RO Furtun gradina
H Damil szegélynyíró géphez
E Hilo de cortar



No.	Ø (mm)	L (m)	profil	☐
89441	2.0	120	○	27
89442	2.4	90	○	27
89443	2.6	70	○	27
89444	3.0	56	○	27

PL Żyłka tnąca
GB Grass trimmer line
D Mähfaden
RUS Леска для триммера
CZ Struna do strunové sekačky
RO Furtun gradina
H Damil szegélynyíró géphez
E Hilo de cortar



No.	Ø (mm)	L (m)	profil	☐
89452	2.4	90	□	16
89453	2.6	70	□	16
89454	3.0	56	□	16

PL Żyłka tnąca
GB Grass trimmer line
D Mähfaden
RUS Леска для триммера
CZ Struna do strunové sekačky
RO Furtun gradina
H Damil szegélynyíró géphez
E Hilo de cortar



No.	Ø (mm)	L (m)	profil	☐
89456	2.0	90	☆	9/27
89457	2.4	90	☆	9/27
89458	2.6	90	☆	9/27
89459	3.0	60	☆	9/27

PL Żyłka tnąca
GB Grass trimmer line
D Mähfaden
RUS Леска для триммера
CZ Struna do strunové sekačky
RO Furtun gradina
H Damil szegélynyíró géphez
E Hilo de cortar



No.	Ø (mm)	L (m)	profil	☐
89401	1.3	10	○	20/240
89402	1.6	10	○	20/240
89403	2.0	10	○	20/240
89404	2.4	10	○	12/144
89405	2.6	10	○	12/144
89406	3.0	10	○	12/144

PL Żyłka tnąca
GB Grass trimmer line
D Mähfaden
RUS Леска для триммера
CZ Struna do strunové sekačky
RO Furtun gradina
H Damil szegélynyíró géphez
E Hilo de cortar



No.	Ø (mm)	L (m)	profil	☐
89411	1.3	10	□	20/240
89412	1.6	10	□	20/240
89413	2.0	10	□	20/240
89414	2.4	10	□	12/144
89415	2.6	10	□	12/144
89416	3.0	10	□	12/144

PL Żyłka tnąca
GB Grass trimmer line
D Mähfaden
RUS Леска для триммера
CZ Struna do strunové sekačky
RO Furtun gradina
H Damil szegélynyíró géphez
E Hilo de cortar

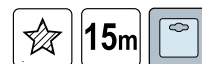

No.	Ø (mm)	L (m)	profil	☐
89421	1.3	15	☆	24/288
89422	1.6	15	☆	20/240
89423	2.0	15	☆	16/192
89424	2.4	15	☆	12/144
89425	2.6	15	☆	12/144
89426	3.0	15	☆	10/120

PL Żyłka tnąca
GB Grass trimmer line
D Mähfaden
RUS Леска для триммера

CZ Struna do strunové sekačky
RO Furtun gradina
H Damil szegélynyíró géphez
E Hilo de cortar

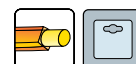

No.	Ø (mm)	L (m)	profil	☐
89462	2.4	15	☐	10/120
89463	2.7	15	☐	10/120
89464	3.0	12	☐	10/120

EXTRANYL

PL Żyłka tnąca
GB Grass trimmer line
D Mähfaden
RUS Леска для триммера
CZ Struna do strunové sekačky
RO Furtun gradina
H Damil szegélynyíró géphez
E Hilo de cortar

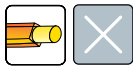

EXTRANYL

No.	Ø (mm)	L (m)	profil	
89465	2.4	90		10/20
89466	2.7	70		10/20
89467	3.0	60		10/20

PL Żyłka tnąca
GB Grass trimmer line
D Mähfaden
RUS Леска для триммера
CZ Struna do strunové sekačky
RO Furtun gradina
H Damil szegélynyíró géphez
E Hilo de cortar

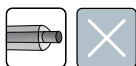

TRYGON

No.	Ø (mm)	L (m)	profil	
89473	2.4	90		10/20
89474	2.7	70		10/20
89475	3.0	60		10/20

PL Żyłka tnąca
GB Grass trimmer line
D Mähfaden
RUS Леска для триммера

CZ Struna do strunové sekačky
RO Furtun gradina
H Damil szegélynyíró géphez
E Hilo de cortar



SILENT

No.	Ø (mm)	L (m)	profil	
89478	1.6	15		20/240
89479	2.0	15		20/240
89480	2.4	15		10/120
89481	2.7	15		10/120
89482	3.0	12		10/120

PL Glowica do wiertarki samozaciskowej
GB Drill chuck
D Schnellspanbohrfutter
RUS Патрон сверлильный быстрозажимной

CZ Hlava na vrtáčku samosvorná
RO Mandrină cu autostrângere pt. bormașină
H Az önbeszorulós fúrógéptokmányfej
E Cabeza para taladradora autoapriete



No.	Ø (mm)	size / rozmiar	
79570	1-10	3/8" (10.0 mm)	8/40
79572	1-10	1/2" (12.5 mm)	8/40

PL Żyłka tnąca
GB Grass trimmer line
D Mähfaden
RUS Леска для триммера

CZ Struna do strunové sekačky
RO Furtun gradina
H Damil szegélynyíró géphez
E Hilo de cortar

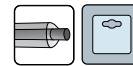

TRYGON

No.	Ø (mm)	L (m)	profil	
89470	2.4	15		10/120
89471	2.7	15		10/120
89472	3.0	12		10/120

PL Żyłka tnąca
GB Grass trimmer line
D Mähfaden
RUS Леска для триммера
CZ Struna do strunové sekačky
RO Furtun gradina
H Damil szegélynyíró géphez
E Hilo de cortar



SILENT

No.	Ø (mm)	L (m)	profil	
89483	2.0	90		10/20
89484	2.4	90		10/20
89485	2.7	70		10/20
89486	3.0	60		10/20

PL Przyłącze do węzła do pomp zatopialnych
GB Hose connection
D Druckleitung-Anschlussstütze
RUS Соединитель для шланга
CZ Koleno k hadici
RO Ștuț de fixare furtun
H Tömlő csatlakozó
E Tubuladura para manguera para bombas de inmersiyn



No.	
79919	100

PL Glowica do wiertarki samozaciskowej
GB Drill chuck
D Schnellspanbohrfutter
RUS Патрон сверлильный быстрозажимной

CZ Hlava na vrtáčku samosvorná
RO Mandrină cu autostrângere pt. bormașină
H Az önbeszorulós fúrógéptokmányfej
E Cabeza para taladradora autoapriete



No.	Ø (mm)	size / rozmiar	
79580	2-13	1/2" (12.5 mm)	5/40

- PL Glowica do wiertarki na klucz
GB Drill chuck
D Scnellspanbohrfutter
RUS Патрон сверлильный ключевой
- CZ Hlava na vrtáčku na klíč
RO Mandrină cu cheie pt. bormașină
H Az önbeszoruló fúrógéptokmányfej
E Cabeza para taladradora de llave



No.	Ø (mm)	size / rozmiar	Icon
79600	1.5-10	3/8" (10.0 mm)	10/50
79620	1.5-10	1/2" (12.5 mm)	10/50
79630	1.5-13	1/2" (12.5 mm)	5/40

- PL Ostrzarka do wiertarki
GB Rotary sharpener
D Bohrerschärfer-Bohrmaschinenaufsatz
RUS Точило для ножей и ножиц
- CZ Brousek na nože a nůžky
RO Rezerva pt dispozitiv de ascuțit burghie
H Élezőkö fúrógépbe fogható
E Muela afilar cuchillos y tijeras

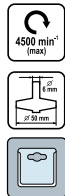

No.	Icon
26225	80/240

- PL Ostrzarka wielofunkcyjna
GB Multi-function sharpener
D Multifunktionales Schärfergerät
RUS Многофункциональный заточной станок
CZ Viceúčelová bruska
RO Mașină de ascuțit multifuncțională
H Multifunkciós élezőgép
E Afiador multifuncional

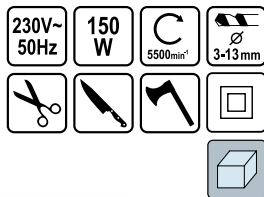

$L_{pA} = 81,56 \pm 3,0$ dB; $L_{wA} = 94,56 \pm 3,0$ dB

No.	W	Icon
73473	150	2

- PL Adapter SDS-plus - UNF 1/2"
GB Adapter SDS-plus - UNF 1/2"
D Adapter SDS-plus - UNF 1/2"
RUS Переходник с SDS плюс на 1/2 дюйма
CZ Přenoska SDS-plus - UNF 1/2"
RO Adaptor SDS-plus - UNF 1/2"
H SDS-plus adapter - UNF 1/2"
E Adaptor SDS-plus - UNF 1/2"



No.	size / rozmiar	Icon
79800	1/2" (12.5 mm)	12/144

- PL Wielofunkcyjna ostrzarka do wiertel
GB Multipurpose drill bit sharpener
D Vielzweck Bohrerschleifgerät
RUS Машина для заточки сверл
- CZ Ostržka pro ostění vrtáků
RO Masina de ascuțit burghie
H Fúróélező
E Afiadora de brocas

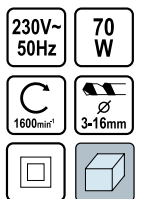

TWO ABRASIVE DISCS
DWIE TARCZE ŚCIERNE

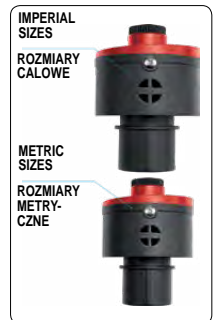

$L_{pA} = 61,0 \pm 3,0$ dB; $L_{wA} = 74,0 \pm 3,0$ dB

No.	W	Icon
73470	70	6

- PL Statyw do szlifierek kątowych
GB Angle grinder stand
D Winkelschleif-Trennständer
RUS Штатив
- CZ Stojan pro úhlovou brusku
RO Stativ pt. polizor unghiular
H Állvány sarokcsiszolóhoz
E Soporte para lijadora de ángulo



No.	Icon
79641	4

- PL Stojak do wiertarki
- GB Drill stand
- D Bohrmaschinenständer
- RUS Сверлильная станция
- CZ Stativ do vrtacky
- RO Suport masina de gaurit
- H Fúróállvány
- E Soporte para taladro

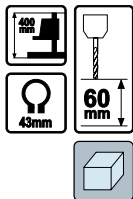

VOREL

No.	h (mm)	pcs	Box
79640	400	10	

- PL Tarniki trzpieniowe
- GB Rotary file set
- D Raspelaufsatz
- RUS Набор металлических бор-фрез
- CZ Hrotové rašple
- RO Set raspile cu tija
- H Fareszlőkészlet, csapszárás
- E Escofinas



No.	Ø (mm)	pcs	Box
25450	6	5	25/200

- PL Zestaw końcówek do szlifierki
- GB Mini grinder accessories set
- D Schleifaufsätze
- RUS Набор шлифовальных и полировочных насадок для арт. 79316
- CZ Soustava koncovek na brusku
- RO Set pietre abrazive si pasta pt. slefuit
- H Fejkészlet csiszológéphez
- E Juego de puntas de pulir



VOREL

No.	pcs	Box
25411	17	10/50

- PL Zapasowe ostrza do struga elektrycznego
- GB Spare cutting knife for electric planner
- D Hobelmesser für Elektrohobel
- RUS Лезвия для электрорубанка
- CZ Náhradní nůž pro elektr. hobliku
- RO Lamă de rezervă pt. rindea electrică
- H Tartalék gyalukés elektromos gyalugéphez
- E Filos de repuesto para cepillo eléctrico



STHOR

No.	pcs	Box
79346	2	30/360

- PL Kamienie szlifierskie trzpieniowe
- GB Mounted stone set
- D Schleifsteinaufsätze
- RUS Набор абразивных наконечников
- CZ Brusné kameny hrotové
- RO Set pietre abrazive cu tija
- H Csiszolókó készlet, csapszárás
- E Discos de esmeril

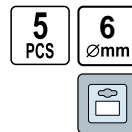

No.	Ø (mm)	pcs	Box
25400	6	5	25/200

- PL Zestaw końcówek do szlifierki
- GB Mini grinder accessories set
- D Schleifaufsätze
- RUS Набор шлифовальных и полировочных насадок для арт. 79316
- CZ Soustava koncovek na brusku
- RO Set pietre abrazive si pasta pt. slefuit
- H Fejkészlet csiszológéphez
- E Juego de puntas de pulir



VOREL

No.	pcs	Box
25410	13	10/50

- PL Zestaw końcówek do szlifierki
- GB Mini grinder accessories set
- D Schleifaufsätze
- RUS Набор шлифовальных и полировочных насадок для арт. 79316
- CZ Soustava koncovek na brusku
- RO Set pietre abrazive si pasta pt. slefuit
- H Fejkészlet csiszológéphez
- E Juego de puntas de pulir



VOREL

No.	pcs	Box
25412	22	10/50

- PL Tarniki trzpieniowe CZ Hrotovité rašple
 GB Rotary file set RO Raspeluri cu coadă
 D Profil-Frärsatz H Fareszelókészlet, csapszáras
 RUS Набор фасонных фрез E Escofinas



No.	pcs	
25405	6	50/300

- PL Wkłady klejowe CZ Lepici vložky
 GB Glue sticks RO Articole plastic (pt. pistol lipit)
 D Heissklebeatronen H Ragasztóbetét
 RUS Тубы для клеящего пистолета E Cartucho de cola



application: cardboard, wood, plastic, leather, fabrics
 zastosowanie: tektura, drewno, plastik, skóra, tkaniny

No.	mm	kg	
73300	11x200	1	10

- PL Zestaw „trzecia ręka”
 GB Helping hand with magnifying glass
 D Hilfhand mit Lupe
 RUS Комплект „третья ручка” с лупой
 CZ Sada „třetí ruka”
 RO Ceava cu lupa
 H Paneltartó állvány „harmadik kéz”
 E Juego „la tercera mano” con lupa



No.	glass / szkło Ø (mm)	
73500	62	10/40

- PL Spoiwo lutownicze
 GB Solder
 D Lötzinn
 RUS Припой
 CZ Pájka
 RO Sarmă de sudură
 H Forrasztó ón
 E Estaño plata



No.	Ø (mm)	weight / waga (g)	
76800	0.5	100	30
76801	0.5	250	20
76806	0.7	100	30
76807	0.7	250	20
76810	1.0	100	30

- PL Nakładki polerujące CZ Leštící kotouč
 GB Polishing covers RO Polizor captusit
 D Polierscheibe H Polírozó korong
 RUS Полировочные накладки E Fundas



No.	Ø (mm)	for / dla	pcs	
82941	245	82940	2	10/100

- PL Wkłady klejowe CZ Lepici vložky
 GB Glue sticks RO Articole plastic (pt. pistol lipit)
 D Heissklebeatronen H Ragasztóbetét
 RUS Тубы для клеящего пистолета E Cartucho de cola

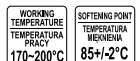

application: cardboard, wood, plastic, leather, fabrics
 zastosowanie: tektura, drewno, plastik, skóra, tkaniny



No.	mm	pcs	
73260	7x100	12	50/200
73270	11x100	6	20/120
73271	11x150	12	20/60

- PL Stojak do lutownicy CZ Stojan na pájku
 GB Soldering iron stand RO Suport pt. ciocan lipit
 D LötKolbenständer H Forrasztópáka tartó
 RUS Подставка для паяльника E Caballete de soldador



No.		
79386		50/100



No.	Ø (mm)	weight / waga (g)	
76811	1.0	250	20
76814	1.5	100	30
76815	1.5	250	20
76818	2.0	100	30
76819	2.0	250	20
76822	2.5	100	30
76823	2.5	250	20
76826	3.0	100	30
76827	3.0	250	20

PL Spoiwo lutownicze CZ Pájka
 GB Solder RO Sarna de sudura
 D Lötzinn H Forrasztó ón
 RUS Припой E Estaño plata



No.	Ø (mm)	weight / waga (g)	
76830	1.0	16	25/250

PL Cyna w lasce CZ Pájka v tyčkách
 GB Solder stick RO Baghete de sudura
 D Stangenlötzinn H Forrasztó rúd
 RUS Припой E Barra estaño plomo



No.	dimensions / wymiary (mm)	weight / waga (kg)	
76832	7x7x322	5	1

PL Pasta lutownicza CZ Pájeci pasty
 GB Solder paste RO Pasta decapante sudura
 D Lotpaste H Forrasztó paszta
 RUS Паяльная паста E Pasta de soldar



No.	weight / waga (g)	
76835	40	50

PL Odsysacz do cyny CZ Odpájeci saci pumpa
 GB Desoldering pump RO Pompa fluidor
 D Entlötsaugpumpe H Ónszippantó
 RUS Шприц для удаления припоя E Bomba desoldadora



No.	
79390	100/400

PL Zestaw narzędzi lutowniczych CZ Pájeci príslušenství
 GB Soldering accessories RO Accesorii de lipit
 D Lötzubehör H Forrasztó tartozékok
 RUS Принадлежности для пайки E Jooteseadmed tarvikud

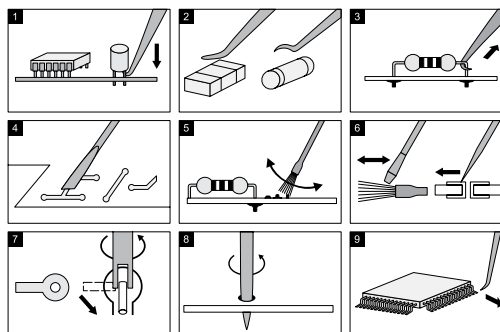

No.	pcs	
79398	6	25/100

PL Kalafonia lutownicza CZ Kalafuna
 GB Rosin RO Colofoniu
 D Kolophonium H Forrasztó gyanta
 RUS Канифоль E Colofonia



No.	weight / waga (g)	
76836	45	50

PL Odsysacz do cyny CZ Odpájeci saci pumpa
 GB Desoldering pump RO Pompa fluidor
 D Entlötsaugpumpe H Ónszippantó
 RUS Шприц для удаления припоя E Bomba desoldadora



No.	
79391	70/140

- PL Wąż tłoczny do motopomp z końcówkami
- GB Pumping hose for motor pumps with terminals
- D Druckschlauch für Motorpumpen mit Anschlussstücken
- RUS Напорный рукав для мотопомп с наконечниками
- CZ Výtlačná hadice s koncovkami pro motorová čerpadla
- RO Furtun pt. motopompe cu capete
- H Szivattyú nyomótömlő kapcsokkal szerelve
- E Manguera para bombear para motobombas con terminales



No.	L (m)	Ø	max. working pressure / max. ciśnienie robocze (bar)	bursting pressure / ciśnienie rozrywające (bar)	
79977	20	2" (50 mm)	6	24	1
79978	20	3" (75 mm)	6	24	1
79979	20	4" (100 mm)	6	24	1

- PL Wąż tłoczny do motopomp
- GB Pumping hose for motor pumps
- D Druckschlauch für Motorpumpen
- RUS Напорный рукав для мотопомп
- CZ Výtlačná hadice pro motorová čerpadla
- RO Furtun pt. motopompe
- H Szivattyú nyomótömlő
- E Manguera para bombear para motobombas



No.	L (m)	Ø	max. working pressure / max. ciśnienie robocze (bar)	bursting pressure / ciśnienie rozrywające (bar)	
79982	50	1" (25 mm)	2	6	1
79983	50	2" (50 mm)	2	6	1
79984	50	3" (75 mm)	2	6	1

Memo

16

Welding equipment Sprzęt spawalniczy



Welding machines
Spawarki

278-279

Welding accessories
Akcesoria spawalnicze

279-284

**Clamps**

Zaciski spawalnicze..... 279

Welding goggles & masks

Okulary i maski spawalnicze..... 279

Hammers

Młotki..... 282

Lock grip pliers

Szczypce zaciskowe..... 282

Tin snips

Nożyce do blachy..... 283

PL Spawarka inwerterowa
GB Inverter welder
D Inverter-Schweißanlage
RUS Инверторный сварочный аппарат
CZ Svářečka inverterová
RO Invertor sudura
H Hegesztő trafo
E Soldadora de inversión

230V~ 50 Hz	IGBT	MMA	140A	DUTY CYCLE CYCLE PRACY 60%
ELECTRODE SIZE ROZMIAR ELEKTRODY 1.6*3.2 mm	ARC FORCE STABILIZACJA ŁUKU	POWER GENERATOR SUPPLY MOCY I ENERGII Z GENERATORA	WINDING INSULATION CLASS KLASA IZOLACJI LIZOWANIA	PROTECTION GRADE STOPNIEN OCHRONY IP21S
			F	



POWER UP

No.	A	
73200	140	2

PL Spawarka inwerterowa
GB Inverter welder
D Inverter-Schweißanlage
RUS Инверторный сварочный аппарат
CZ Svářečka inverterová
RO Invertor sudura
H Hegesztő trafo
E Soldadora de inversión

230V~ 50 Hz	IGBT	MMA	180A	DUTY CYCLE CYCLE PRACY 60%
ELECTRODE SIZE ROZMIAR ELEKTRODY 1.6*5.0 mm	ARC FORCE STABILIZACJA ŁUKU	POWER GENERATOR SUPPLY MOCY I ENERGII Z GENERATORA	ANTI STICK FUNKCJA PRZECIWI ZWARCOWIA	CONSTANT CURRENT STALY PRĄD SPAWANIA
			H	



POWER UP

No.	A	
73202	180	2

PL Spawarka inwerterowa
GB Inverter welder
D Inverter-Schweißanlage
RUS Инверторный сварочный аппарат
CZ Svářečka inverterová
RO Invertor sudura
H Hegesztő trafo
E Soldadora de inversión

230V~ 50Hz	IGBT	MMA	HOT START GORĄCY START	ANTI STICK FUNKCJA PRZECIWI ZWARCOWIA	ARC FORCE STABILIZACJA ŁUKU
140A	DUTY CYCLE CYCLE PRACY 20%	ELECTRODE SIZE ROZMIAR ELEKTRODY 1.0~4.0 mm	PROTECTION GRADE STOPNIEN OCHRONY IP21S	WINDING INSULATION CLASS KLASA IZOLACJI LIZOWANIA	F



STHOR

No.	A	
73205	140	1

PL Spawarka inwerterowa
GB Inverter welder
D Inverter-Schweißanlage
RUS Инверторный сварочный аппарат
CZ Svářečka inverterová
RO Invertor sudura
H Hegesztő trafo
E Soldadora de inversión

230V~ 50 Hz	IGBT	MMA	160 A	DUTY CYCLE CYCLE PRACY 60%
ELECTRODE SIZE ROZMIAR ELEKTRODY 1.6*4 mm	ARC FORCE STABILIZACJA ŁUKU	POWER GENERATOR SUPPLY MOCY I ENERGII Z GENERATORA	WINDING INSULATION CLASS KLASA IZOLACJI LIZOWANIA	PROTECTION GRADE STOPNIEN OCHRONY IP21S
			F	



POWER UP

No.	A	
73201	160	2

PL Spawarka inwerterowa
GB Inverter welder
D Inverter-Schweißanlage
RUS Инверторный сварочный аппарат
CZ Svářečka inverterová
RO Invertor sudura
H Hegesztő trafo
E Soldadora de inversión

230V~ 50 Hz	IGBT	MMA	200A	DUTY CYCLE CYCLE PRACY 60%
ELECTRODE SIZE ROZMIAR ELEKTRODY 1.6*5.0 mm	ARC FORCE STABILIZACJA ŁUKU	POWER GENERATOR SUPPLY MOCY I ENERGII Z GENERATORA	ANTI STICK FUNKCJA PRZECIWI ZWARCOWIA	CONSTANT CURRENT STALY PRĄD SPAWANIA
			H	



POWER UP

No.	A	
73203	200	2

PL Spawarka inwerterowa
GB Inverter welder
D Inverter-Schweißanlage
RUS Инверторный сварочный аппарат
CZ Svářečka inverterová
RO Invertor sudura
H Hegesztő trafo
E Soldadora de inversión

230V~ 50Hz	IGBT	MMA	HOT START GORĄCY START	ANTI STICK FUNKCJA PRZECIWI ZWARCOWIA	ARC FORCE STABILIZACJA ŁUKU
160A	DUTY CYCLE CYCLE PRACY 20%	ELECTRODE SIZE ROZMIAR ELEKTRODY 1.0~4.0 mm	PROTECTION GRADE STOPNIEN OCHRONY IP21S	WINDING INSULATION CLASS KLASA IZOLACJI LIZOWANIA	F

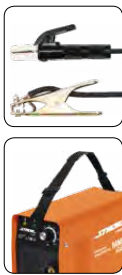

STHOR

No.	A	
73206	160	1

PL Spawarka inwerterowa
 GB Inverter welder
 D Inverter-Schweißanlage
 RUS Инверторный сварочный аппарат
 CZ Svářečka inverterová
 RO Invertor sudura
 H Hegesztő trafó
 E Soldadora de inversión

230V~ 50Hz	IGBT	MMA	HOT START GORĄCY START	ANTI STICK FUNKCJA PRZECIWN ZWARCOWA	ARC FORCE STABILIZACJA ŁUKU
180 A	DUTY CYCLE CYKL PRACY 15%	ELECTRODE SIZE ROZMIAR ELEKTRODY 1.0-5.0mm	PROTECTION GRADE STABILIZACJA IP21S	INSULATION CLASS KLASA IZOLACJI UZYSKIWANA F	POWER GENERATOR SUPPLY MOŻLIWOŚĆ ZASILANIA Z GENERATORA



STWOR

No.	A	
73207	180	1

PL Zacisk spawalniczy
 biegunowo-kleszczowy
 GB Clamp
 D Schweisseklemme
 RUS Клещи для сварки

CZ Kleště svářečské zemnicí
 RO Cleste pt. sudura
 H Testkábel-csatlakozó
 E Cocardillo para soldar



No.	max welding current / max prąd spawania (A)	Ø earthing cable / Ø kabla masyowego (mm ²)	max range / max rozwarcie (mm)	weight / waga (kg)	type	
74420	160	35	50	0.21	ZBK-35	25
74421	315	70	60	0.25	ZBK-70	25
74422	520	95	70	0.29	ZBK-95	25

PL Okulary spawalnicze
 GB Welding goggles
 D Schweisserbrille
 RUS Очки газосварщика

CZ Brýle svářečské
 RO Ochelari pt. sudura
 H Hegesztőszemüveg
 E Gafas para soldar

TITLED FRAME UCHYLNÁ OPRAWA	ADJUSTABLE REGULOWANY	IMPACT RESISTANT OPORNY NA UDARZENIA	FILTER FILTR DIN 5
FILTER FILTR Ø50mm	PROTECTION LENS SZYBKA OCHRONNA Ø50mm	WITH VENTILATION Z WENTYLACJĄ	FOR GAS WELDING DO SPAWANIA GĄZOWEGO
		FOR GRINDING DO SZLIFOWANIA	



VOREL

No.		
74400		25/100

PL Spawarka inwerterowa
 GB Inverter welder
 D Inverter-Schweißanlage
 RUS Инверторный сварочный аппарат
 CZ Svářečka inverterová
 RO Invertor sudura
 H Hegesztő trafó
 E Soldadora de inversión

230V~ 50Hz	IGBT	MMA	HOT START GORĄCY START	ANTI STICK FUNKCJA PRZECIWN ZWARCOWA	ARC FORCE STABILIZACJA ŁUKU
200 A	DUTY CYCLE CYKL PRACY 10%	ELECTRODE SIZE ROZMIAR ELEKTRODY 1.0-6.0mm	PROTECTION GRADE STABILIZACJA IP21S	INSULATION CLASS KLASA IZOLACJI UZYSKIWANA F	POWER GENERATOR SUPPLY MOŻLIWOŚĆ ZASILANIA Z GENERATORA

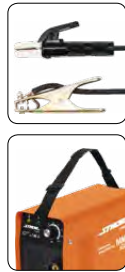

STWOR

No.	A	
73208	200	1

PL Uchwyt spawalniczy elektrodowy
 GB Electrode holder
 D Schweisselectrodengriff
 RUS Клещи для сварки (электродные)

CZ Držák elektrod
 RO Cleste pt. sudura cu electrod
 H Elektrodafogó
 E Abrazadera para soldar, de electrodos



No.	max welding current / max prąd spawania (A)	electrode diameter / średnica elektrod (mm)	Ø welding cable / Ø przewodu spawalniczego (mm ²)	weight / waga (kg)	type	
74430	200A (X=60%) / 315A (X=35%)	35-50	2-5	0.32	UE-200	25
74431	315A (X=60%) / 400A (X=35%)	50-70	2.5-6.3	0.42	UE-300	25
74432	430A (X=60%) / 530A (X=35%)	70-95	3.5-6.3	0.50	UE-400	25

PL Okulary spawalnicze
 GB Welding goggles
 D Schweisserbrille
 RUS Очки газосварщика

CZ Brýle svářečské
 RO Ochelari pt. sudura
 H Hegesztőszemüveg
 E Gafas para soldar

TITLED FRAME UCHYLNÁ OPRAWA	ADJUSTABLE REGULOWANY	IMPACT RESISTANT OPORNY NA UDARZENIA	FILTER FILTR DIN 5
FILTER FILTR Ø50mm	PROTECTION LENS SZYBKA OCHRONNA Ø50mm	FOR GAS WELDING DO SPAWANIA GĄZOWEGO	FOR GRINDING DO SZLIFOWANIA



No.		
74410		5/100

PL Okulary spawalnicze
GB Welding goggles
D Schweisserbrille
RUS Очки газосварщика

CZ Brýle svářečské
RO Ochelari pt. sudura
H Hegesztőszemüveg
E Gafas para soldar

TITLED FRAME UCHYLNA OPRAWA	ADJUSTABLE REGULOWANY	IMPACT RESISTANT ODPORNY NA UDERZENIA	FILTER FILTR DIN 5
FILTER FILTR Ø50mm	PROTECTION LENS SZYBKA OCHRONNA Ø50mm	FOR GAS WELDING DO SPAWANIA GAZOWEGO	FOR GRINDING DO SZLIFOWANIA



No. type
74411 10/100

PL Maska spawalnicza
GB Welding mask
D Schweissermaske
RUS Щиток сварщика
CZ Svářečská maska
RO Mască de sudură
H Hegesztőpajzs
E Mascara de soldador



FILTER SIZE ROZMIAR FILTRA 50x100 mm	222x372 x80 mm
FILTER FILTR DIN 10	WEIGHT WITHOUT LENS WAGA BEZ SZYBKI 366 g

No. type
74442 TSMM 30

PL Maska spawalnicza
GB Welding mask
D Schweissermaske
RUS Щиток сварщика
CZ Svářečská maska
RO Mască de sudură
H Hegesztőpajzs
E Mascara de soldador



FILTER SIZE ROZMIAR FILTRA 50x100 mm	257x450 x96 mm
WEIGHT WITHOUT LENS WAGA BEZ SZYBKI 455 g	

No. type
74450 TSD-3 20

PL Przyłbica spawalnicza z podglądem
GB Welding mask
D Schweissermaske
RUS Щиток сварщика с подсмотром
CZ Svářečská přilba s nakoukáváním
RO Mască de sudură cu geam
H Hegesztősisak kitékintővel
E Mascara de soldador con mirador



FILTER SIZE ROZMIAR FILTRA 50x100 mm DIN 8-13	SPECTACLE LENS SIZE ROZMIAR SZYBKI 20x100 mm (DIN 5)	225x290 x175 mm
FILTER FILTR DIN 10	WEIGHT WITHOUT LENS WAGA BEZ SZYBKI 427 g	

No. type
74448 PS-3 10

PL Maska spawalnicza
GB Welding mask
D Schweissermaske
RUS Щиток сварщика
CZ Svářečská maska
RO Mască de sudură
H Hegesztőpajzs
E Mascara de soldador



FILTER SIZE ROZMIAR FILTRA 50x100 mm	237x359 x78 mm
FILTER FILTR DIN 8	WEIGHT WITHOUT LENS WAGA BEZ SZYBKI 268 g

No. type
74440 TSM-3 30

PL Maska spawalnicza
GB Welding mask
D Schweissermaske
RUS Щиток сварщика
CZ Svářečská maska
RO Mască de sudură
H Hegesztőpajzs
E Mascara de soldador



FILTER SIZE ROZMIAR FILTRA 50x100 mm	SPECTACLE LENS SIZE ROZMIAR SZYBKI 20x100 mm (DIN 5)	222x372 x80 mm
FILTER FILTR DIN 10	WEIGHT WITHOUT LENS WAGA BEZ SZYBKI 408 g	

No. type
74443 TSMP 20

PL Przyłbica spawalnicza z podglądem
GB Welding mask
D Schweissermaske
RUS Щиток сварщика с подсмотром
CZ Svářečská přilba s nakoukáváním
RO Mască de sudură cu geam
H Hegesztősisak kitékintővel
E Mascara de soldador con mirador



FILTER SIZE ROZMIAR FILTRA 50x100 mm DIN 8-13	SPECTACLE LENS SIZE ROZMIAR SZYBKI 20x100 mm (DIN 5)	195x265 x170 mm
FILTER FILTR DIN 10	WEIGHT WITHOUT LENS WAGA BEZ SZYBKI 332 g	

No. type
74447 PSMP 20

PL Maska spawalnicza
GB Welding mask
D Schweissermaske
RUS Щиток сварщика
CZ Svářečská maska
RO Mască de sudură
H Hegesztőpajzs
E Mascara de soldador



110x90 mm
FILTER FILTR DIN 12



No. type
74441 20

PL Przyłbica spawalnicza
GB Welding mask
D Schweissmaske
RUS Щиток сварщика

CZ Svářečská přilba s nakoukaváním
RO Mască de sudură cu geam
H Hegesztősisak kitekintővel
E Mascara de soldador con mirador



No.	74457	20
-----	-------	----

PL Przyłbica spawalnicza samościemniająca
GB Auto-darkening welding helmet
D Schweissmaske, selbstverdunkelnd
RUS Маска для сварки, самостоятельно затемняющаяся
CZ Svářečská kukla samostmívací
RO Mască de sudură auto-întunecare
H Önmagától sötétedő hegesztőpajzs
E Casco auto-oscurecedor para soldadura

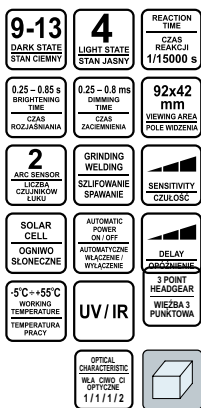

No.	74480	6
-----	-------	---

PL Przyłbica spawalnicza samościemniająca
GB Auto-darkening welding helmet
D Schweissmaske, selbstverdunkelnd
RUS Маска для сварки, самостоятельно затемняющаяся
CZ Svářečská kukla samostmívací
RO Mască de sudură auto-întunecare
H Önmagától sötétedő hegesztőpajzs
E Casco auto-oscurecedor para soldadura

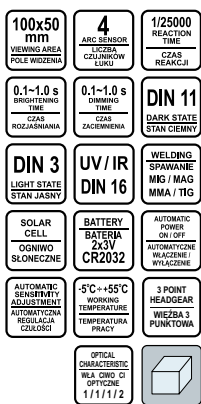

No.	74484	6
-----	-------	---

PL Przyłbica spawalnicza
GB Welding helmet
D Schweissmaske
RUS Щиток сварщика

CZ Svářečská maska
RO Mască de sudură
H Hegesztőpajzs
E Mascara de soldador



No.	74449	12
-----	-------	----

PL Przyłbica spawalnicza samościemniająca
GB Auto-darkening welding helmet
D Schweissmaske, selbstverdunkelnd
RUS Маска для сварки, самостоятельно затемняющаяся
CZ Svářečská kukla samostmívací
RO Mască de sudură auto-întunecare
H Önmagától sötétedő hegesztőpajzs
E Casco auto-oscurecedor para soldadura

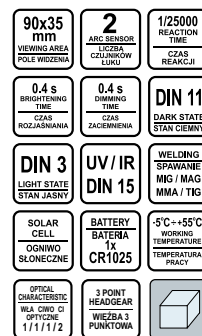

No.	74483	6
-----	-------	---

PL Osłona filtra
GB Filter shield
D Filterabdeckung
RUS Кожах фильтра

CZ Ochrana filtra
RO Aparatoare de filtru
H Szűrőfedél
E Protección de filtro

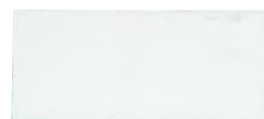

No.	74451	50x100	mm	type / typ	DIN 0	150
-----	-------	--------	----	------------	-------	-----

- PL Filtr spawalniczy
- GB Welding filter
- D Vorsatzglas
- RUS Фильтр для сварки
- CZ Filtr svářečský
- RO Filtru pt. sudări
- H Hegesztőszűrő
- E Pantalla de filtro de soldador



No.	mm	type / typ	
74452	50x100	DIN 8	100
74453	50x100	DIN 9	100
74454	50x100	DIN 10	100
74455	50x100	DIN 11	100

- PL Młotek blacharski, guma - plastik
- GB Soft faced mallet
- D Ausbeulhammer
- RUS Молоток рихтовочный
- CZ Klempířské kladívko
- RO Ciocan pt. tabla
- H Bádogos kalapács
- E Mazo goma-plastico



No.	mm	
33950	35	30/60

- PL Młotek spawalniczy
- GB Welder's hammer
- D Schweisserhammer
- RUS Молоток сварочный
- CZ Svářečské kladívko
- RO Ciocan de sudură
- H Hegesztő kalapács
- E Martillo para soldar



No.	g	
32110	350	5

- PL Szczypce zaciskowe klamrowe typu „C”
- GB Welding locking pliers „C” type
- D Klemm- und Klammerzange vom Typ „C”
- RUS Клещи давяльные типа „С”
- CZ Kleště samosvorné upínací typu „C”
- RO Clește de strângere cu clemă tip „C”
- H „C” fogó
- E Pinzas de tornillo (de apriete) de grapa tipo „C”

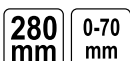

No.	L (mm)	type	
44301	280	C	6/30

- PL Osłona filtra przyłbicy samościemniającej
- GB Self-dimming helmet filter protection
- D Filterersatz eines selbstabdunkelnden Schutzhelmes
- RUS Кожух фильтра самозатемняющегося шлица
- CZ Ochranná folie filtru samostmívací kukly
- RO Carcasă filtru vizieră heliomată
- H Hegesztőpajzs szűrő, önsötétedő
- E Protección del filtro de visera autooscurecedora



No.	mm	pcs	
74439	90x110	5	20

- PL Młotek drewniany blacharski
- GB Wooden mallet
- D Holzhammer für Bleche
- RUS Молоток жестящика, деревянный
- CZ Palice dřevěná klempířská
- RO Ciocan din lemn de tinichigiu
- H Bádogos fakalapács
- E Martillo de madera de hojalatero



No.	mm	
33532	285	20

- PL Szczypce spawalnicze
- GB Lock grip pliers
- D Schweisserzange
- RUS Ключ - зажим
- CZ Svářečské kleště
- RO Cleste autoblocant pt. sudura
- H Hegesztő fogó
- E Alicates de soldar



No.	L (mm)	type	
44300	275	C	6/36

- PL Szczypce spawalnicze
- GB Lock grip pliers
- D Schweisserzange
- RUS Ключ - зажим
- CZ Svářečské kleště
- RO Cleste autoblocant pt. sudura
- H Hegesztő fogó
- E Alicates de soldar

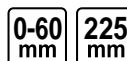

No.	L (mm)	type	
44400	225	U	6/36

PL Szczypcy spawalnicze CZ Svářečské kleště
 GB Lock grip pliers RO Cleste autoblocant pt. sudura
 D Schweisszange H Hegesztő fogó
 RUS Ключ - зажим E Alicates de soldar

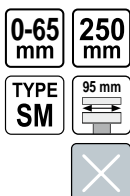

No.	L (mm)	type	
44500	250	SM	6/36

PL Nożyce do blachy CZ Nůžky na plech
 GB Figure tin snips RO Foarfece pt. tablă
 D Blechscherer H Lemezvágó olló
 RUS Ножницы по металлу E Tijeras para hojalata



No.	L (mm)	max (mm)	
48060	250	1.2	6/48

PL Nożyce do blachy CZ Nůžky na plech
 GB Figure tin snips RO Foarfece pt. tablă
 D Blechscherer H Lemezvágó olló
 RUS Ножницы по металлу E Tijeras para hojalata



No.	L (mm)	
48100	250	6/60

PL Nożyce do blachy CZ Nůžky na plech
 GB Figure tin snips RO Foarfece pt. tablă
 D Blechscherer H Lemezvágó olló
 RUS Ножницы по металлу E Tijeras para hojalata



No.	L (mm)	
48200	250	6/60

PL Nożyce do blachy CZ Nůžky na plech
 GB Figure tin snips RO Foarfece pt. tablă
 D Blechscherer H Lemezvágó olló
 RUS Ножницы по металлу E Tijeras para hojalata

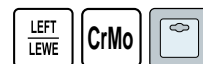

No.	L (mm)	max (mm)	
48000	250	1.5	6/36

PL Nożyce do blachy CZ Nůžky na plech
 GB Figure tin snips RO Foarfece pt. tablă
 D Blechscherer H Lemezvágó olló
 RUS Ножницы по металлу E Tijeras para hojalata



No.	L (mm)	max (mm)	
48080	250	1.0	6/36

PL Nożyce do blachy CZ Nůžky na plech
 GB Figure tin snips RO Foarfece pt. tablă
 D Blechscherer H Lemezvágó olló
 RUS Ножницы по металлу E Tijeras para hojalata



No.	L (mm)	max (mm)	
48082	250	1.0	6/36

PL Nożyce do blachy CZ Nůžky na plech
 GB Figure tin snips RO Foarfece pt. tablă
 D Blechscherer H Lemezvágó olló
 RUS Ножницы по металлу E Tijeras para hojalata



No.	L (mm)	max (mm)	
48050	250	1.5	6/36

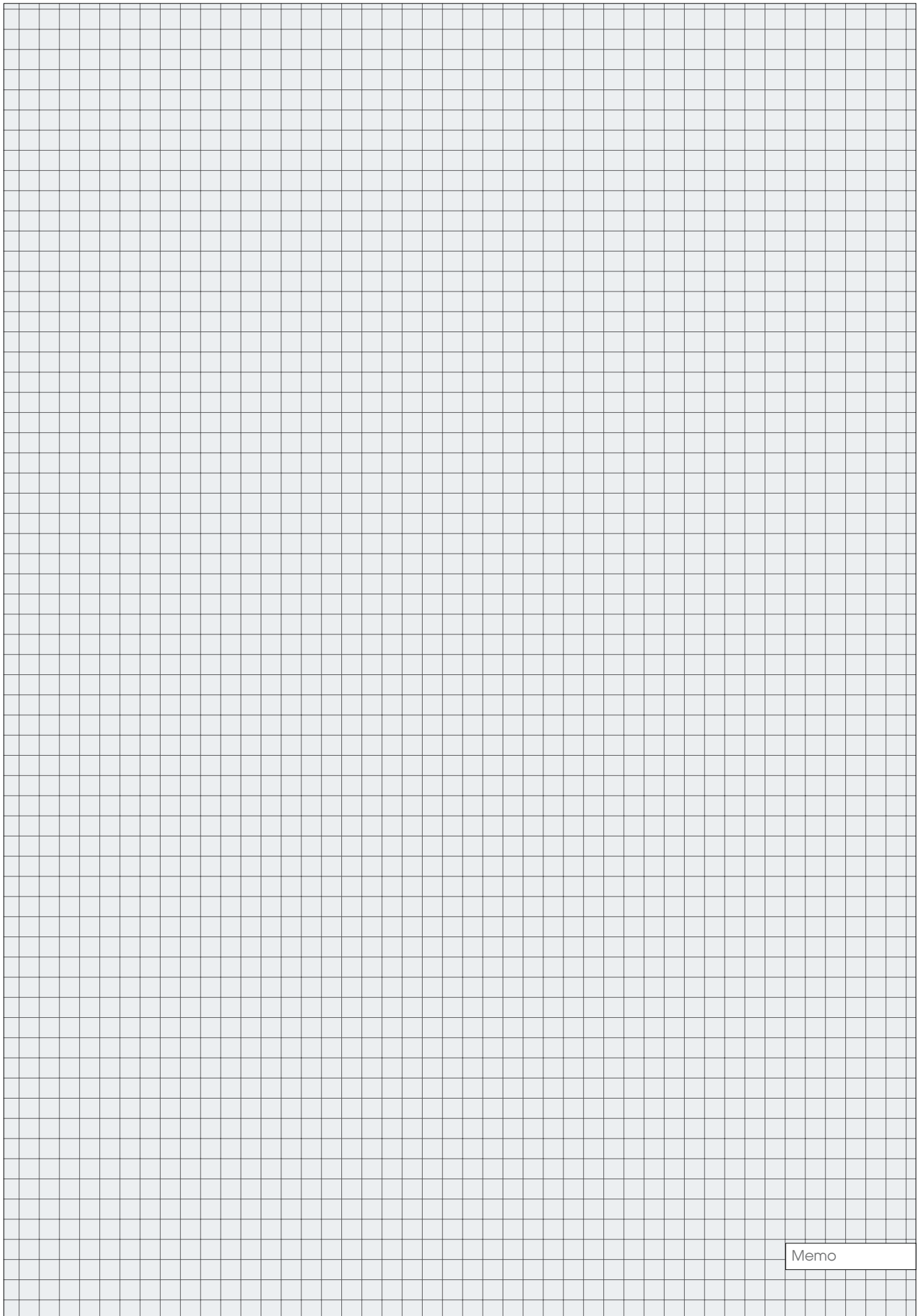

Memo

17

Safes, padlocks & locks Sejfy, klódki i zamki



Safes
Sejfy

.....288

**Key boxes**
Skrzynki na klucze

.....288

**Cash boxes**
Kasetki na pieniądze

.....288-289

**Padlocks**
Kłódki

.....289-291

**Cast iron padlocks**

Kłódki żeliwne..... 289

Brass padlocks

Kłódki mosiężne..... 290

Lock cylinders & bodies
Wkładki do zamków i zamki

.....291-292

**Brass lock cylinders**

Wkładki mosiężne..... 291

Safety chains

Łańcuchy do drzwi..... 291

Door closers

Samozamykacze..... 291

Door peep holes

Wizjery..... 292

Bicycle & motorcycle locks
Zamknięcia do rowerów i motocykli

.....292-293



PL Sejf z zamkiem cyfrowym
GB Safe with digital lock
D Seif mit Digitalschloss
RUS Сейф с электронным замком

CZ Pancéřová pokladna z digitálním zámkem
RO Seif cu broasca cu cifru
H Számzáras széf
E Caja de seguridad con cerradura digital



No.	cm	
78641	35x25x25	1

PL Skrzynka na klucze
GB Key box
D Schlüsselkasten
RUS Ящик для ключей
CZ Skříňka na klíče
RO Cutie pt. chei
H Kulcstartó doboz
E Caja para llaves

200x160x78
mm

2x
15x
HOOKS
HACZYKÓW



No.	size / rozmiar (mm)	
78432	200x160x78	20

PL Skrzynka na klucze
GB Key box
D Schlüsselkasten
RUS Ящик для ключей

CZ Skříňka na klíče
RO Cutie pt. chei
H Kulcstartó doboz
E Caja para llaves

450x380x80
mm

2x
80x
HOOKS
HACZYKÓW



No.	size / rozmiar (mm)	
78436	450x380x80	5

PL Kasetka na pieniądze
GB Cash box
D Geldkassette
RUS Ящик для денег
CZ Kasetá na peníze
RO Casetá (cutie) pt. bani
H Pénzes kassetta
E Caja para efectivo

200x160x90
mm

2x
KEY



No.	size / rozmiar (mm)	colour / kolor	
78622	200x160x90	●	10

PL Sejf z zamkiem cyfrowym
GB Safe with digital lock
D Seif mit Digitalschloss
RUS Сейф с электронным замком

CZ Pancéřová pokladna z digitálním zámkem
RO Seif cu broasca cu cifru
H Számzáras széf
E Caja de seguridad con cerradura digital



No.	cm	
78642	31x20x20	1

PL Skrzynka na klucze
GB Key box
D Schlüsselkasten
RUS Ящик для ключей

CZ Skříňka na klíče
RO Cutie pt. chei
H Kulcstartó doboz
E Caja para llaves

250x180x80
mm

2x
48x
HOOKS
HACZYKÓW



No.	size / rozmiar (mm)	
78434	250x180x80	10

PL Kasetka na pieniądze
GB Cash box
D Geldkassette
RUS Ящик для денег
CZ Kasetá na peníze
RO Casetá (cutie) pt. bani
H Pénzes kassetta
E Caja para efectivo

150x120x80
mm

2x
KEY



No.	size / rozmiar (mm)	colour / kolor	
78620	150x120x80	●	20

PL Kasetka na pieniądze
GB Cash box
D Geldkassette
RUS Ящик для денег
CZ Kasetá na peníze
RO Casetá (cutie) pt. bani
H Pénzes kassetta
E Caja para efectivo

200x160x90
mm

CODE
SZYFR



No.	size / rozmiar (mm)	colour / kolor	
78624	200x160x90	●	10

- PL Kasetka na pieniądze
- GB Cash box
- D Geldkassette
- RUS Ящик для денег
- CZ Kазeta na peníze
- RO Casetă (cutie) pt. bani
- H Pénzes kasszeta
- E Caja para efectivo

A5
SIZE
ROZMIAR

250x200x90
mm

2x 



No.	size / rozmiar (mm)	colour / kolor	
78626	250x200x90	●	10

- PL Kasetka na pieniądze
- GB Cash box
- D Geldkassette
- RUS Ящик для денег
- CZ Kазeta na peníze
- RO Casetă (cutie) pt. bani
- H Pénzes kasszeta
- E Caja para efectivo

A4
SIZE
ROZMIAR

300x240x90
mm

2x 



No.	size / rozmiar (mm)	colour / kolor	
78630	300x240x90	●	10

- PL Kłódka żelwna
- GB Iron padlock
- D Vorhängeschloss
- RUS Замок навесной
- CZ Stavební visací zámek
- RO Lacăt pt. construcții
- H Óriás lakat
- E Candado de hierro fundido

3x  



No.	L (mm)	
77061	32	12/120
77062	38	12/120
77063	50	6/60
77064	63	6/36

- PL Kasetka na pieniądze
- GB Cash box
- D Geldkassette
- RUS Ящик для денег
- CZ Kазeta na peníze
- RO Casetă (cutie) pt. bani
- H Pénzes kasszeta
- E Caja para efectivo

A5
SIZE
ROZMIAR

250x180x90
mm

CODE
SZYFR



No.	size / rozmiar (mm)	colour / kolor	
78628	250x180x90	●	10

- PL Kasetka na pieniądze
- GB Cash box
- D Geldkassette
- RUS Ящик для денег
- CZ Kазeta na peníze
- RO Casetă (cutie) pt. bani
- H Pénzes kasszeta
- E Caja para efectivo

2x 



No.	size / rozmiar (mm)	colour / kolor	
78632	180x115x55	●	24
78633	240x155x55	●	20

- PL Kłódka żelwna powlekana
- GB Alloy covered iron padlock
- D Vorhängeschloss
- RUS Замок навесной
- CZ Stavební visací zámek
- RO Lacăt pt. construcții
- H Óriás lakat
- E Candado de hierro fundido

4x  



No.	L (mm)	
77004	40	12/96
77005	50	12/72
77006	60	12/48

PL Klódka żeliwna
GB Alloy covered iron padlock
D Vorhängeschloss
RUS Замок навесной

CZ Stavební visací zámek
RO Lacăt pt. construcții
H Óriás lakat
E Candado de hierro fundido



No.	L (mm)	
77230	40	6/72
77231	50	6/72

PL Klódka trzpieniowa
GB Rectangular brass padlock
D Messigvorhängeschloss
RUS Стержневой навесной замок латунный
CZ Visací zámek čerový
RO Lacăt din alamă cu belciug drept
H Réz hengerzárás u lakat
E Candado de latón de mandril



No.	L (mm)	
77210	50	6/120
77211	65	6/96
77212	75	6/60
77213	90	6/36

PL Klódka mosiężna
GB Plated brass padlock
D Vorhängeschloss
RUS Замок навесной латунный

CZ Zámek visací mosazný
RO Lacăt alama
H Lakat sárgaréz
E Candado de latón



No.	L (mm)	pcs	
77603	25	4	12/120

PL Klódka trzpieniowa
GB Alloy covered padlock
D Vorhängeschloss
RUS Стержневой навесной замок чугуный

CZ Stavební visací zámek
RO Lacăt pt. construcții
H Óriás lakat
E Candado de mandril de hierro fundido cubierto



No.	L (mm)	
77241	90	6/24

PL Klódka mosiężna
GB Plated brass padlock
D Vorhängeschloss
RUS Замок навесной латунный
CZ Zámek visací mosazný
RO Lacăt alama
H Lakat sárgaréz
E Candado de latón



No.	L (mm)	
77250	25	12/600
77300	30	12/480
77350	35	12/300
77400	40	12/240
77500	50	12/144
77600	60	12/144

PL Klódka sztyrowa
GB Brass combination padlock
D Vorhängeschloss
RUS Замок навесной
CZ Zámek visací s číselným klíčem
RO Lacăt alama cu cifru
H Lakat sárgaréz számkombinációs
E Candado de latón



No.	
77607	12/120

PL Kłódka mosiężna
GB Plated brass padlock
D Vorhängeschloss
RUS Замк

CZ Zámek visací mosazný
RO Lacet alama
H Lakat sárgaréz
E Candado de latón



No.	mm	
77700	40x105	12/240

PL Wkładka do zamka chromowana
GB Lock cylinder
D Schliesszylinder
RUS Личинка замка

CZ Vložka na zámek
RO Yalá pt. broască
H Zárbetét
E Inserción cromado



BRASS
MOSIADZ



No.	L (mm)	mm	key / klucz pcs	
77170	62	31/31	3	12/72
77171	67	31/36	3	12/72

PL Wkładka do zamka chromowana
GB Lock cylinder
D Schliesszylinder
RUS Личинка замка

CZ Vložka na zámek
RO Yalá pt. broască
H Zárbetét
E Inserción cromado



BRASS
MOSIADZ



No.	L (mm)	mm	key / klucz pcs	
77180	62	31/31	6	12/72

PL Łańcuch do drzwi
GB Safety chain
D Türsicherungskette
RUS Замок-цепь для двери

CZ Řetěz na dveře
RO Lanț pt. ușă
H Ajtólánc
E Cadena para puerta



No.		
77910		12/120

PL Wkładka do zamka
GB Lock cylinder
D Schliesszylinder
RUS Личинка замка латунная

CZ Vložka na zámek
RO Yalá pt. broască
H Zárbetét
E Inserción cromado



BRASS
MOSIADZ



No.	L (mm)	mm	key / klucz pcs	
77200	62	31/31	3	12/72
77203	72	31/41	3	12/72
77204	67	31/36	3	12/72
77205	87	36/51	3	12/72

PL Wkładka do zamka
GB Lock cylinder
D Schliesszylinder
RUS Личинка замка латунная

CZ Vložka na zámek
RO Yalá pt. broască
H Zárbetét
E Inserción cromado



BRASS
MOSIADZ



No.	L (mm)	mm	key / klucz pcs	
77190	62	31/31	6	12/72
77191	67	31/36	6	12/72
77192	72	31/41	6	12/72
77193	87	36/51	6	12/72

PL Łańcuch do drzwi
GB Safety chain
D Türsicherungskette
RUS Замок-цепь для двери

CZ Řetěz na dveře
RO Lanț pt. ușă
H Ajtólánc
E Cadena para puerta



No.		
77900		12/120

PL Automacyjny zamykacz do drzwi
GB Door closer
D Automatischer Türschließer
RUS Доводчик дверной

CZ Automatický zavírač dveří
RO Încuietoare automată ușă
H Ajtófék
E Muelle de puerta

120°
180°

LATCH
CONTROL
DOMYKANIE
0-12°

AI



No.	kg	
78463	45-65	10

PL Wizjer z klapką
GB Door peep hole with flap
D Türspion
RUS Глазок дверной с заслонкой

CZ Hledáček s klapkou
RO Vizor cu clăpîță
H Kitekintő, fedéllel
E Mirilla con tapa



No.	mm	angle / kąť	
77920	35-50	200°	40/480

PL Zawieszki plastikowe do kluczy
GB Key indicators
D Schlüsselanhänger
RUS Брелок для ключей

CZ Přívěšek na klíče
RO Breloc
H Kulcstartó
E Llaveros de plástico

12
PCS



No.	pcs	
77930	12	12/120

PL Linka rowerowa
GB Bicycle lock
D Fahrradschloss
RUS Замок велосипедный

CZ Zámek jízdního kola
RO Antifurt pt. bicicleta
H Kerékpárzár
E Cable antirrobo para bicicletas

65
cm **8**
Ømm



No.	L (cm)	Ø (mm)	colour / kolor	
77831	65	8		12/120

PL Linka rowerowa
GB Bicycle lock
D Fahrradschloss
RUS Замок велосипедный

CZ Zámek jízdního kola
RO Antifurt pt. bicicleta
H Kerékpárzár
E Cable antirrobo para bicicletas



No.	L (cm)	Ø (mm)	colour / kolor	
77837	120	8		10/60
77838	150	10		10/60

PL Wizjer z klapką
GB Door peep hole with flap
D Türspion
RUS Глазок дверной с заслонкой

CZ Hledáček s klapkou
RO Vizor cu clăpîță
H Kitekintő, fedéllel
E Mirilla con tapa



No.	mm	angle / kąť	
77921	35-50	200°	48/480

PL Linka rowerowa
GB Bicycle lock
D Fahrradschloss
RUS Замок велосипедный

CZ Zámek jízdního kola
RO Antifurt pt. bicicleta
H Kerékpárzár
E Cable antirrobo para bicicletas

65
cm **8**
Ømm



No.	L (cm)	Ø (mm)	colour / kolor	
77830	65	8		12/120

PL Linka rowerowa
GB Bicycle lock
D Fahrradschloss
RUS Замок велосипедный

CZ Zámek jízdního kola
RO Antifurt pt. bicicleta
H Kerékpárzár
E Cable antirrobo para bicicletas



No.	L (cm)	Ø (mm)	colour / kolor	
77833	120	8		10/60
77834	120	10		10/60
77835	180	10		10/60

PL Linka rowerowa
GB Bicycle lock
D Fahrradschloss
RUS Замок велосипедный

CZ Zámek jízdního kola
RO Antifurt pt. bicicleta
H Kerékpárzár
E Cable antirrobo para bicicletas

120
cm **10**
Ømm



No.	L (cm)	Ø (mm)	colour / kolor	
77845	120	10		20/40

- PL Linka rowerowa
GB Bicycle lock
D Fahrradschloss
RUS Замок велосипедный
- CZ Zámek jízdního kola
RO Antifurt pt. bicicleta
H Kerékpárzár
E Cable antirrobo para bicicletas



No.	L (cm)	Ø (mm)	colour / kolor	☐
77840	180	12	●●●	10/40

- PL Zapięcie rowerowe
GB Bicycle lock
D Fahrradschloss
RUS Замок велосипедный
- CZ Zámek jízdního kola
RO Antifurt pt. bicicleta
H Kerékpárzár
E Cable antirrobo para bicicletas



No.	L (cm)	Ø (mm)	☐
77850	100	18	12/24

- PL Zapięcie łańcuchowe z zamkiem
GB Chain lock
D Kettenverschluss mit Schloss
RUS Цепь с замком
- CZ Bezpečnostní řetěz se zámkem
RO Încuietoare lanț cu lacăt
H Kerékpár lakat
E Candado de cadena con cerradura



No.	L (cm)	Ø (mm)	☐
77881	120	7	12

- PL Zapięcie typu U-lock
GB U-type lock
D Bügelschloss
RUS Замок до мотоцикла
- CZ Zámek na kolo „U” typ
RO Anti-furt tip „U”
H U-lakat motorbiciklihez
E Candado tipo „U”



No.	L (cm)	Ø (mm)	☐
77872	30	15	5/10

- PL Linka stalowa z klódką
GB Security cable and lock
D Stahlseil, mit Vorhängeschloss
RUS Канат стальной с замком
- CZ Ocelové lanko s visacím zámkem
RO Sârmă de oțel cu lacăt
H Drótkötél, lakattal
E Cuerda de acero con candado



No.	L (m)	Ø (mm)	☐
77815	3	4	12/48

- PL Zapięcie motocyklowe
GB Motorcycle lock
D Stahlgliederschloss
RUS Замок до мотоцикла
- CZ Zámek na kolo
RO Anti-furt motocicletă
H Lánclakat motorbiciklihez
E Candado para Moto



No.	L (cm)	Ø (mm)	☐
77861	150	25	6/12

- PL Zapięcie typu U-lock
GB U-type lock
D Bügelschloss
RUS Замок до мотоцикла
- CZ Zámek na kolo „U” typ
RO Anti-furt tip „U”
H U-lakat motorbiciklihez
E Candado tipo „U”







No.	L (cm)	Ø (mm)	☐
77870	21	13	10/20





18

Accessories Akcesoria

Tool belts Pasy na narzędzia	
..... 296	
Tool bags Torby narzędziowe	
..... 296	
Trolley tool boxes Wózki narzędziowe	
..... 296-297	
Tool boxes Skrzynki narzędziowe	
..... 297-299	

- PL Pas narzędziowy z naszytymi torbami
 GB Tool belt with fixed bags
 D Werkzeuggürtel mit Taschen
 RUS Пояс для инструментов с карманами
- CZ Opasek na nářadí s taškami
 RO Centura de scule cu pungii fixe
 H Szerszám öv táská
 E Cinturón para herramientas con bolsas

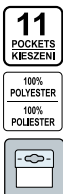

No.	78751	24
-----	-------	----

- PL Pas monterski
 GB Tool belt
 D Leder-Gürteltasche
 RUS Пояс монтажника кожаный
- CZ Montážský pás kožený
 RO Centura port scule - piele
 H Bőr szerszámösöv
 E Cinturón de montaje de piel



No.	78750	50
-----	-------	----

- PL Torba narzędziowa
 GB Tool bag
 D Werkzeugkoffer
 RUS Сумка для инструмента
- CZ Nástrojová taška
 RO Geantă pt. scule
 H Szeszámöstáska
 E Maletin de herramientas



No.	78720	430x285x170	2
-----	-------	-------------	---

- PL Wózek narzędziowy
 GB Trolley tool box
 D Werkzeugtrolley
 RUS Мешок для инструментов
- CZ Vozík na nářadí
 RO Troler pt. scule
 H Kerek szerszámosláda
 E Carro de herramientas



No.	78731	2
-----	-------	---

- PL Pas narzędziowy stolarski z przesuwanymi torbami
 GB Tool belt with sliding bags
 D Werkzeuggürtel mit Taschen
 RUS Пояс для инструментов со сменными карманами
- CZ Opasek na nářadí s taškami
 RO Centura de scule cu pungii glisante
 H Szerszám öv táská
 E Cinturón para herramientas con bolsas



No.	78752	24
-----	-------	----

- PL Torba narzędziowa
 GB Tool bag
 D Werkzeugkoffer
 RUS Сумка для инструмента
- CZ Nástrojová taška
 RO Geantă pt. scule
 H Szeszámöstáska
 E Maletin de herramientas



No.	78700	380x250x110	4
No.	78710	455x280x130	2

- PL Torba narzędziowa
 GB Tool bag
 D Werkzeugkoffer
 RUS Сумка для инструмента
- CZ Nástrojová taška
 RO Geantă pt. scule
 H Szeszámöstáska
 E Maletin de herramientas



No.	78730	400x260x140	2
-----	-------	-------------	---



EXTERNAL / ZEWNĘTRZNY
 45x25x29.5 cm
 INTERNAL / WEWNĘTRZNY
 41x21x23 cm

EXTERNAL / ZEWNĘTRZNY
 46x26x33.5 cm
 INTERNAL / WEWNĘTRZNY
 41x21x32 cm



- PL Wózek narzędziowy z wyjmowanym organizerem
- GB Trolley tool box
- D Werkzeugtrolley mit abnehmbarem Organizationalaufsatz
- RUS Мешок для инструментов с вынимаемым организером
- CZ Vozík na nářadí s odnímatelným organizérem
- RO Troler pt. scule
- H Kerekes szerszámosláda kivehető szervezővel
- E Carro de herramientas con organizador extraíble

46x22
x62/84
cm

PP



No.	
78734	2

- PL Wózek narzędziowy 3-segmentowy
- GB Trolley tool box 3 segments
- D Werkzeugtrolley 3-Teilig
- RUS Мешок для инструментов 3 секции
- CZ Vozík na nářadí 3 segmenty
- RO Troler pt. scule 3 segmente
- H Kerekes szerszámosláda 3 részés
- E Carro de herramientas 3 compartimentos

57x37
x84.5
cm

3
SEGMENTS
SEGMENTOWY

54-98cm

ABS

STEEL
STAL



No.	
78738	1

- PL Wózek narzędziowy 3-segmentowy
- GB Trolley tool box 3 segments
- D Werkzeugtrolley 3-Teilig
- RUS Мешок для инструментов 3 секции
- CZ Vozík na nářadí 3 segmenty
- RO Troler pt. scule 3 segmente
- H Kerekes szerszámosláda 3 részés
- E Carro de herramientas 3 compartimentos

45x28
x82/104
cm

3
SEGMENTS
SEGMENTOWY

PP

ABS



No.	
78736	1

- PL Skrzynka narzędziowa
- GB Tool box
- D Plastikwerkzeugkoffer
- RUS Ящик для инструмента-пластмассовый
- CZ Nástrojová skříňka plastikov
- RO Cutie din plastic pt. scule
- H Szerszámosláda, műanyag
- E Caja de herramientas de plástico



No.	size / rozmiar	dimensions / wymiary (mm)	
78801	12" (30 cm)	312x167x130	1
78800	16" (40 cm)	415x226x200	1

- PL Skrzynka narzędziowa
- GB Tool box
- D Plastikwerkzeugkoffer
- RUS Ящик для инструмента-пластмассовый
- CZ Nástrojová skříňka plastikov
- RO Cutie din plastic pt. scule
- H Szerszámosláda, műanyag
- E Caja de herramientas de plástico



No.	size / rozmiar	dimensions / wymiary (mm)	
78802	20" (50 cm)	525x256x246	1

PL Skrzynka narzędziowa
 GB Tool box
 D Plastikwerkzeugkoffer
 RUS Ящик для инструмента-пластмассовый

CZ Nástrojová skříňka plastikov
 RO Cutie din plastic pt. scule
 H Szerszámoszláda, műanyag
 E Caja de herramientas de plástico



No.	size / rozmiar	dimensions / wymiary (mm)	
78811	12" (30 cm)	312x167x130	1
78812	16" (40 cm)	415x226x200	1
78813	20" (50 cm)	525x256x246	1
78815	26" (65 cm)	595x337x316	1

PL Szufiadki warsztatowe
 GB Workshop drawers
 D Werkstatt Schubfächer
 RUS Ящики для инструментов
 CZ Skříňka se zásobníky
 RO Sertare atelier
 H Műhely zsámoly fiókkal
 E Cajones para taller



No.	dimensions / wymiary (mm)	compartments / szufiadki	
78785	225x155x100	10	20

PL Organizer Domino
 GB Organizer
 D Werkzeugkaste
 RUS Органайзер
 CZ Organizér
 RO Cutie tip organizator
 H Mű. csavartartó doboz
 E Caja



No.	dimensions / wymiary (mm)	compartments / przegródki	
78793	120x100x30	8	38

PL Skrzynka narzędziowa
 GB Tool box
 D Plastikwerkzeugkoffer
 RUS Ящик для инструмента-пластмассовый

CZ Nástrojová skříňka plastikov
 RO Cutie din plastic pt. scule
 H Szerszámoszláda, műanyag
 E Caja de herramientas de plástico



No.	size / rozmiar	dimensions / wymiary (mm)	load capacity / noşność (kg)	
78814	20" (50 cm)	525x256x325	25 + 3	1

PL Organizer
 GB Organizer
 D Werkzeugkaste
 RUS Органайзер

CZ Organizér
 RO Cutie tip organizator
 H Mű. csavartartó doboz
 E Caja



No.	dimensions / wymiary (mm)	compartments / przegródki	
78790	200x145x35	7	10

PL Organizer
 GB Organizer
 D Werkzeugkaste
 RUS Органайзер

CZ Organizér
 RO Cutie tip organizator
 H Mű. csavartartó doboz
 E Caja



No.	dimensions / wymiary (mm)	compartments / przegródki	
78791	300x220x55	10	10

PL Organizer Domino
GB Organizer
D Werkzeugkaste
RUS Органайзер

CZ Organizér
RO Cutie tip organizator
H Mű. csavartartó doboz
E Caja



No.	dimensions / wymiary (mm)	
78794	360x270	5

PL Pojemnik magazynowy
GB Storage case
D Lagersichtbox
RUS Ящик для склада

CZ Box skladovací
RO Cutie scule diverse
H Tárolók
E Contenedor de almacen



No.	dimensions / wymiary (mm)	
78819	460x320	5

PL Pojemnik magazynowy
GB Container
D Vorratsbehälter
RUS Ящик складской

CZ Box skladovací
RO Cutie depozitare
H Tároló doboz
E Caja de almacenamiento



No.	type	dimensions / wymiary (mm)	
78821	P-1	108x110x75	40
78822	P-2	160x115x75	40
78824	P-4	235x173x125	20
78825	P-5	340x200x150	9
78826	P-6	440x315x180	6







No.	type / typ	dimensions / wymiary (mm)	
78830	XS	116x112x75	270
78831	S	116x161x75	190
78833	M	170x240x126	44
78834	L	204x340x155	27
78835	XL	333x500x187	7

Memo	
------	--

19

Bicycle accessories Akcesoria rowerowe



Bicycle lamps Lampy rowerowe	
.....302	
Bicycle & motorcycle locks Zamknięcia do rowerów i motocykli	
.....302-303	
Bicycle pumps Pompki rowerowe	
.....304-305	
Bicycle tools Narzędzia rowerowe	
.....305	

- PL Lampa rowerowa przednia LED
 GB LED front bike light
 D Fahrrad Frontscheinwerfer LED
 RUS Светодиодный фонарик для велосипеда
- CZ Přední světla LED na kolo
 RO Lanterna pt. bicicleta LED
 H LED-es első kerékpár lámpa
 E Linterna LED frontal para bicicleta

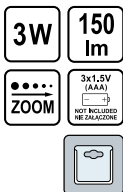

POWER LED



VOREL

No.	battery / bateria	
88411	3x1.5V	12/48

- PL Zestaw lamp rowerowych LED
 GB LED bike light set
 D Fahrrad-Beleuchtungsset LED
 RUS Набор светодиодных велосипедных фонарей
- CZ Set LED osvětlení na kolo
 RO Set lanterna bicicleta LED
 H LED kerékpár lámpa szett
 E Juego de luces LED para bicicleta

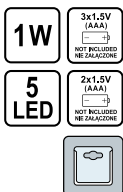

POWER LED



VOREL

No.	battery / bateria	
88421	3x1.5V / 2x1.5V	12/120

- PL Linka rowerowa
 GB Bicycle lock
 D Fahrradschloss
 RUS Замок велосипедный
- CZ Zámek jízdního kola
 RO Antifurt pt. bicicleta
 H Kerékpárzár
 E Cable antirrobo para bicicletas



VOREL

No.	L (cm)	Ø (mm)	colour / kolor	
77831	65	8	● ● ●	12/120

- PL Linka rowerowa
 GB Bicycle lock
 D Fahrradschloss
 RUS Замок велосипедный
- CZ Zámek jízdního kola
 RO Antifurt pt. bicicleta
 H Kerékpárzár
 E Cable antirrobo para bicicletas



VOREL

No.	L (cm)	Ø (mm)	colour / kolor	
77837	120	8	● ● ●	10/60
77838	150	10	● ● ●	10/60

- PL Zestaw lamp rowerowych LED
 GB LED bike light set
 D Fahrrad-Beleuchtungsset LED
 RUS Набор светодиодных велосипедных фонарей
- CZ Set LED osvětlení na kolo
 RO Set lanterna bicicleta LED
 H LED kerékpár lámpa szett
 E Juego de luces LED para bicicleta



POWER LED



VOREL

No.	battery / bateria	
88422	3x1.5V / 2x1.5V	12/48

- PL Linka rowerowa
 GB Bicycle lock
 D Fahrradschloss
 RUS Замок велосипедный
- CZ Zámek jízdního kola
 RO Antifurt pt. bicicleta
 H Kerékpárzár
 E Cable antirrobo para bicicletas

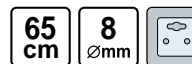

VOREL

No.	L (cm)	Ø (mm)	colour / kolor	
77830	65	8	● ● ●	12/120

- PL Linka rowerowa
 GB Bicycle lock
 D Fahrradschloss
 RUS Замок велосипедный
- CZ Zámek jízdního kola
 RO Antifurt pt. bicicleta
 H Kerékpárzár
 E Cable antirrobo para bicicletas



VOREL

No.	L (cm)	Ø (mm)	colour / kolor	
77833	120	8	● ● ●	10/60
77834	120	10	● ● ●	10/60
77835	180	10	● ● ●	10/60

- PL Linka rowerowa
 GB Bicycle lock
 D Fahrradschloss
 RUS Замок велосипедный
- CZ Zámek jízdního kola
 RO Antifurt pt. bicicleta
 H Kerékpárzár
 E Cable antirrobo para bicicletas

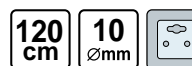

VOREL

No.	L (cm)	Ø (mm)	colour / kolor	
77845	120	10	● ● ●	20/40

PL Linka rowerowa
GB Bicycle lock
D Fahrradschloss
RUS Замок велосипедный

CZ Zámek jízdního kola
RO Antifurt pt. bicicleta
H Kerékpárzár
E Cable antirrobo para bicicletas



No.	L (cm)	Ø (mm)	colour / kolor	☐
77840	180	12	●●●	10/24

PL Zapięcie rowerowe
GB Bicycle lock
D Fahrradschloss
RUS Замок велосипедный

CZ Zámek jízdního kola
RO Antifurt pt. bicicleta
H Kerékpárzár
E Cable antirrobo para bicicletas



No.	L (cm)	Ø (mm)	☐
77850	100	18	12/24

PL Zapięcie łańcuchowe z zamkiem
GB Chain lock
D Kettenverschluss mit Schloss
RUS Цепь с замком

CZ Bezpečnostní řetěz se zámkem
RO Încuietoare lanț cu lacăt
H Kerékpár lakat
E Candado de cadena con cerradura



No.	L (cm)	Ø (mm)	☐
77881	120	7	12

PL Zapięcie typu U-lock
GB U-type lock
D Bügelschloss
RUS Замок до мотоцикла

CZ Zámek na kolo „U” typ
RO Anti-furt tip „U”
H U-lakat motorbiciklihez
E Candado tipo „U”



No.	L (cm)	Ø (mm)	☐
77872	30	15	5/10

PL Linka stalowa z kłódką
GB Security cable and lock
D Stahseil, mit Vorhängeschloss
RUS Канат стальной с замком

CZ Ocelové lanko s visacím zámkem
RO Sârmă de oțel cu lacăt
H Drótkötél, lakattal
E Cuerda de acero con candado



No.	L (m)	Ø (mm)	☐
77815	3	4	12/48

PL Zapięcie motocyklowe
GB Motorcycle lock
D Stahlgliederschloss
RUS Замок до мотоцикла

CZ Zámek na kolo
RO Anti-furt motocicletă
H Láncakát motorbiciklihez
E Candado para Moto



No.	L (cm)	Ø (mm)	☐
77861	150	25	6/12

PL Zapięcie typu U-lock
GB U-type lock
D Bügelschloss
RUS Замок до мотоцикла

CZ Zámek na kolo „U” typ
RO Anti-furt tip „U”
H U-lakat motorbiciklihez
E Candado tipo „U”



No.	L (cm)	Ø (mm)	☐
77870	21	13	10/20



- PL Teleskopowa pompka aluminiowa
 GB Double cylinder aluminium hand pump
 D Aluminium Handpumpe Doppelzylinder
 RUS Насос телескопический алюминиевый
- CZ Pumpa ruční double-pístové hliníkové
 RO Pompa aluminium duo telescope
 H Pumpa alumínium dupla dugattyús
 E Bomba de mano de doble cilindro de aluminio



No.		
82031		60

- PL Pompka nożna z manometrem
 GB Foot pump with manometer
 D Fussluftpumpe mit Manometer
 RUS Насос ножной с манометром
- CZ Nožní pumpa z manometrem
 RO Pompă de picior cu manometru
 H Lábpumpa nyomásmérővel
 E Bomba de pierna con manometro



No.		
82000		20

- PL Pompka tłokowa nożna
 GB Foot pump
 D Fussluftpumpe mit Manometer
 RUS Насос ножной с манометром
- CZ Nožní pumpa z manometrem
 RO Pompă de picior
 H Lábpumpa nyomásmérővel
 E Bomba de pierna con manometro

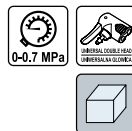

No.	MPa	
82001	0-0.7	12

- PL Pompka słupkowa ręczna
 GB Hand pump
 D Hand-Luftpumpe
 RUS Насос ручной
 CZ Hustička ruční
 RO Pompa de mana cu manometru
 H Kézi pumpa
 E Bomba de barre de mano



No.	MPa	
82020	0.3	20

- PL Pompka rowerowa
 GB Bike hand pump
 D Fahrradpumpe
 RUS Велосипед ручной насос
- CZ Pumpička na kolo
 RO Pompă de bicicletă
 H Kerékpár pumpa
 E Bomba de bicicleta



No.		
82032		60

- PL Pompka tłokowa nożna
 GB Foot pump
 D Fussluftpumpe mit Manometer
 RUS Насос ножной с манометром
- CZ Nožní pumpa z manometrem
 RO Pompă de picior
 H Lábpumpa nyomásmérővel
 E Bomba de pierna con manometro



No.	MPa	
82005	0.7	5

- PL Pompka tłokowa nożna
 GB Foot pump
 D Fussluftpumpe mit Manometer
 RUS Насос ножной с манометром
- CZ Nožní pumpa z manometrem
 RO Pompă de picior
 H Lábpumpa nyomásmérővel
 E Bomba de pierna con manometro



No.	MPa	
82015	0-0.7	6

- PL Pompka słupkowa z manometrem
 GB Hand pump with manometer
 D Hand-Luftpumpe mit Manometer
 RUS Насос ручной с манометром
 CZ Pumpa z manometrem
 RO Pompa de mana cu manometru
 H Kézi pumpa manométerrel
 E Bomba de barre con manometro



No.	MPa	
82021	1	10

- PL Pompka słupkowa z manometrem
- GB Hand pump with manometer
- D Hand-Luftpumpe mit Manometer
- RUS Насос ручной с манометром
- CZ Pumpa z manometrem
- RO Pompa de mana cu manometru
- H Kézi pumpa manométerrel
- E Bomba de barrote con manometro



No.	MPa	Box
82022	0.1-1	10

- PL Zestaw kluczy imbusowych
- GB Hex key set
- D Sechskant-Stiftschluselsatz
- RUS Набор шестигранников
- CZ Imbusové klíče
- RO Chei imbus
- H Imbisz kulcs
- E Juego de llaves hex

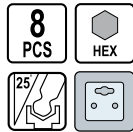

No.	mm	pcs	Box
56505	1.5; 2; 2.5; 3; 4; 5; 6; 8	8	25/100

- PL Zestaw kluczy imbusowych
- GB Hex key set
- D Sechskant-Stiftschluselsatz
- RUS Набор шестигранников
- CZ Imbusové klíče
- RO Chei imbus
- H Imbisz kulcs
- E Juego de llaves hex



No.	mm	pcs	Box
56506	1.5; 2; 2.5; 3; 4; 5; 6; 8	8	25/100

- PL Zestaw kluczy Torx
- GB Torx key set
- D Torx-Stiftschluselsatz
- RUS Набор ключей Torx
- CZ Souprava klíčů Torx
- RO Set de chei Torx
- H Kulcskészlet, Torx
- E Juego de llaves Torx

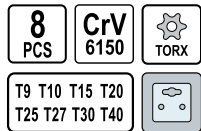

No.	pcs	Box
56507	8	25/100

- PL Zestaw do naprawy roweru
- GB Bike hand tool set
- D Fahrrad-Reparatur-Satz
- RUS Набор инструментов для велосипеда
- CZ Cyklistické nářadí
- RO Instrumente ciclism
- H Kerékpár szerszámok
- E Herramientas ciclismo

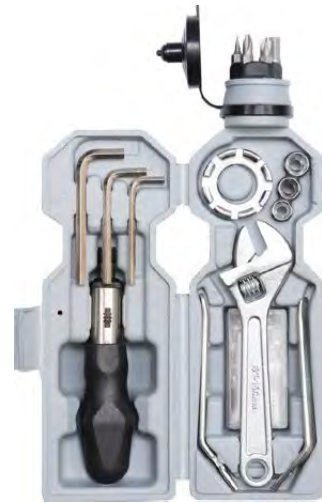

- Set includes / Zestaw zawiera:
- Hex key / Klucze imbusowe: 4mm, 5mm, 6mm
 - Ratchet screwdriver / Wkrętak z grzechotką
 - Adjustable wrench / Klucz nastawny
 - Crowbar / Łyzki do opon rowerowych: x2
 - Sockets / Nasadki: 8mm, 9mm, 10mm
 - Wheels spokes wrench / Klucz do regulacji szprych
 - Bits set + adaptor / Zestaw końcówek wkrętakowych + adaptor
 - Tire repair kit / Zestaw naprawy do dętek



No.	Box
77795	20

- PL Stojak do obsługi rowerów
- GB Bike repair stand
- D Fahrrad-Montageständer
- RUS Стенд для ремонта велосипедов
- CZ Montážní stojan
- RO Stand pt. repararea bicicletei
- H Kerékpár szerelő
- E Soporte de reparación



No.	Box
77715	2

20

Kitchen and home appliance
Sprzęt AGD



Kitchen appliance
Sprzęt AGD do kuchni



.....308-323

Home appliance
Sprzęt AGD do domu



.....323-327

PL Wielofunkcyjny robot kuchenny
GB Multifunctional kitchen robot 12 in1
D Küchenmaschine
RUS Кухонный робот

CZ Kuchyňský robot
RO Robot de bucatarie
H Robotgép
E Robot de cocina



220-240V-50/60Hz	1300 W HEATING EFFICIENCY MOC GRZALNI
800 W	AUTO & MANUAL MODE TRYB AUTOMATYCZNY / TRYB RĘCZNY
12 IN 1 12 W 1	max 4 kg WAGA / WIEKHT
+30°C +120°C	TURBO
10 SPEED 10 PRĘDKOŚCI	

FUNCTIONS / FUNKCJE:

- ✓ Weighing / Ważenie
- ✓ Cooking / Gotowanie / Gotowanie na parze
- ✓ Steaming / Gotowanie na parze
- ✓ Mixing / Miksowanie
- ✓ Blending / Blendowanie
- ✓ Ice crushing / Kruszenie lodu
- ✓ Chopping / Siekanie
- ✓ Grating / Mielenie kawy
- ✓ Grinding / Mielenie mięsa
- ✓ Stirring / Mieszanie składników
- ✓ Whisking / Trzepanie jajek
- ✓ Kneading / Ubijanie



BUTTERFLY BAR / MIESZADŁO

MEASURING CUP / MIARKA



STAINLESS STEEL BOWL 3.5L
MISA ZE STALI NIERDZEWNEJ 3.5L

BIG STEAMER
DUŻY PAROWAR

STEAM BASKET
MAŁY PAROWAR

SPATULA / SZPATULKA

No.	W	
67860	800	1

PL Robot kuchenny
GB Multifunctional kitchen robot
D Küchenmaschine
RUS Кухонный робот

CZ Kuchyňský robot
RO Robotul multifuncțional
H Robotgép
E Robot de cocina

220-240V-50/60Hz	150 W	3 in 1 3 w 1
	180 min ⁻¹	

LUND



THIN SLICING / KROJENIE
CIEŃKICH PŁASTRÓW



THICK SLICING / KROJENIE
GRUBYCH PŁASTRÓW



THIN SHREDDING / TARCIE
DROBNE



THICK SHREDDING / TARCIE
GRUBE



CITRUS JUICER WITH CUP /
WYCISKARKA DO CYTRUSÓW
Z POJEMNIKIEM



PURE BLADE / TARCIE
PŁACKÓW



FOOD PROCESSOR WITH 5
SLICERS / SZATKOWNICA
Z 5 OSTRZAMI



FROZEN FRUIT ICE CREAM
MAKER / MASZYŃKA DO
LÓDÓW

FUNCTIONS / FUNKCJE:

- ✓ Thin slicing / Krojenie cienkich plasterów
- ✓ Thick slicing / Krojenie grubych plasterów
- ✓ Thin shredding / Tarcie drobne
- ✓ Thick shredding / Tarcie grube
- ✓ Puree blade / Tarcie placków

No.	W	
67961	150	6

PL Robot kuchenny
GB Multifunctional kitchen robot 8 in1
D Küchenmaschine
RUS Кухонный робот

CZ Kuchyňský robot
RO Robot de bucatarie
H Robotgép
E Robot de cocina

220-240V-50/60Hz	550 W	8 in 1 8 w 1
x2 SPEEDS PRĘDKOŚCI	PULSE MODE TRYB PULSACYJNY	∅75 mm
x4 SUCTION PADS PRZYSSAWKI	SS STAINLESS STEEL STAL NIERDZEWNA	

- INCLUDED / ZESTAW ZAWIERA:**
- ✓ Chopping / Siekanie
 - ✓ Slicing / Krojenie na plastery
 - ✓ French-fries cutting / Cięcie na frytki
 - ✓ Shredding / Tarcie
 - ✓ Blending / Blendowanie
 - ✓ Grinding / Mielenie
 - ✓ Whisking / Ubijanie
 - ✓ Kneading / Ugniatanie



STORAGE COMPARTMENT FOR
TOOLS / SZUFLADKA
NA AKCESORIA



FOOD PROCESSOR 1.2L/
MALAKSER 1.2L



GRINDER 0.5L / MLYNEK 0.5L



BLENDER JAR WITH STAINLESS
STEEL BLADE 1.5L /
KIELICH Z OSTRZEM ZE STALI
NIERDZEWNEJ 1.5L



DISC FOR BLADES / TARCZA
NA TARKI

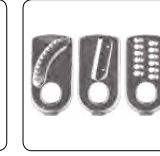

3 BLADES FOR VEGETABLES /
3 TARKI DO WARZYW



LUND



WHISKING DISC / DYSK DO
UBIJANIA



CHOPPING BLADE &
KNEADING TOOL / OSTRZE
DO SIEKANIA I MIESZADŁO
DO UGNATANIA

No.	W	
67950	550	2

PL Mikser planetarny
GB Stand mixer
D Küchenmaschine
RUS Кухонный комбайн

CZ Kuchyňský robot
RO Robotul multifuncțional
H Komplex konyhai robotgép
E Robot de cocina

220-240V-50Hz	1400 W MAX POWER MOC MAXIMALNA	800 W
5.5L BOWL MISA	x6 SPEED PRĘDKOŚĆ	TURBO
	SS STAINLESS STEEL STAL NIERDZEWNA	

LUND



STAND MIXER
MIKSER PLANETARNY



BOWL COVER
OSŁONA PRZECIWBRYZGOWA



STAINLESS STEEL BOWL 5.5L
MISA ZE STALI NIERDZEWNEJ 5.5L



3 MIXING ACCESSORIES
3 KONCÓWKI DO MIESZANIA

No.	W	
67805	800	2

PL Mikser planetarny
GB Stand mixer
D Küchenmaschine
RUS Кухонный комбайн
CZ Kuchyňský robot
RO Robotul multifunctional
H Komplex konyhai robotgép
E Robot de cocina



230V~50Hz
1000 W
1.5 l BLENDER
4.5 l BOWL / MISA
6 SPEEDS PREDKOŚCI
TURBO

LUND



STAND MIXER MIKSER PLANETARNY



BOWL COVER OSŁONA PRZECIWBRYZGOWA



STAINLESS STEEL BOWL 4.5l MISA ZE STALI NIERDZEWNEJ 4.5l



GLASS BLENDER 1.5l SZKLANY BLENDER 1.5l



KNOB WITH BACKLIGHT PODSWIETLANE POKRĘTŁO



3 MIXING ACCESSORIES 3 KONCÓWKI DO MIESZANIA

No.	W	
67810	1000	2

PL Mikser ręczny
GB Hand mixer
D Handmixer
RUS Ручной миксер

CZ Ruční mixér
RO Mixer
H Kézi turmixgép
E Batidora de mano

220-240V~50-60Hz
150W
x5 SPEED PREDKOŚCI



LUND



BASE FOR MIXER AND ACCESSORIES / BAZA NA MIKSERY I AKCESORIA



BEATER AND DOUGH HOOK x2 / TRZEPACZKA I MIESZADŁO x2

No.	W	
67780	150	10

PL Mikser planetarny
GB Stand mixer
D Küchenmaschine
RUS Кухонный комбайн

CZ Kuchyňský robot
RO Robotul multifunctional
H Komplex konyhai robotgép
E Robot de cocina



220-240V~50/60Hz
1500 W
1000 W
4.5l BOWL MISA
1.5 l BLENDER MIKSER
x6 SPEED PREDKOŚCI
TURBO

LUND



STAINLESS STEEL BOWL 4.5 l MISA ZE STALI NIERDZEWNEJ 4.5 l



BOWL COVER OSŁONA PRZECIWBRYZGOWA



MEAT GRINDER MASZYŃKA DO MIELENIA MIĘSA



GLASS BLENDER 1.5 l SZKLANY BLENDER 1.5 l



KNOB WITH BACKLIGHT PODSWIETLANE POKRĘTŁO



SAUSAGE SET ZESTAW DO NAPEŁNIANIA KIEŁBAS



3 MIXING ACCESSORIES 3 KONCÓWKI DO MIESZANIA

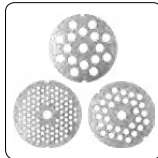

CHANGEABLE BLADES WYMIENNE OSTRZA

No.	W	
67811	1000	2

PL Mikser ręczny
GB Hand mixer
D Handmixer
RUS Ручной миксер

CZ Ruční mixér
RO Mixer
H Kézi turmixgép
E Batidora de mano

220-240V~50-60Hz
200W
x5 SPEED PREDKOŚCI
TURBO
SS STAINLESS STEEL STAL NIERDZEWNA



LUND



BASE FOR MIXER AND ACCESSORIES / BAZA NA MIKSERY I AKCESORIA

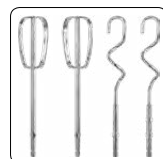

BEATER AND DOUGH HOOK x2 / TRZEPACZKA I MIESZADŁO x2

No.	W	
67781	200	8

PL Mikser ręczny z misą
 GB Hand mixer with bowl
 D Handmixer mit Schale
 RUS Ручной миксер с чашей
 CZ Ruční mixér s mísou
 RO Mixer cu bol
 H Kézi turmixgép tállal
 E Batidora de mano con bol



AUTOMATIC ROTATING BOWL / AUTOMATYCZNA ROTACJA MISY



STAINLESS STEEL BOWL 31 / MISA ZE STALI NIERDZEWNEJ 31



BEATER AND DOUGH HOOK x2 / TRZEPACZKA I MIESZADŁO x2

LUND

No.	W	
67790	200	6

PL Blender ręczny
 GB Hand blender
 D Stabmixer
 RUS Ручной блендер

CZ Ruční mixér
 RO Blender de mana
 H Botmixer
 E Batidora de mano



LUND

INCLUDED / ZESTAW ZAWIERA:

- ✓ Blender 700 W / Blender 700 W
- ✓ Stainless steel blade / Ostrze ze stali nierdzewnej
- ✓ Cup 0.5 l / Pojemnik 0.5 l
- ✓ Stainless steel whisk / Trzepaczka ze stali nierdzewnej
- ✓ Chopper 0.5 l with stainless steel blade / Malakser 0.5 l z ostrzem ze stali nierdzewnej

- ✓ 2 x BPA free tritan bottle 0.6 l with blade and cap / 2 x butelka 0.6 l wolna od BPA wykonana z tritanu z ostrzem i zakrętką
- ✓ Holder for blade and whisk / Podstawa na ostrze i trzepaczkę
- ✓ Food processor 1.5 l with blade and 2-sided cutting plate / Duży malakser 1.5 l z ostrzem i dwustronną tarką tnącą

No.	W	
67701	700	4

PL Blender ręczny
 GB Hand blender
 D Stabmixer
 RUS Ручной блендер

CZ Ruční mixér
 RO Blender de mana
 H Botmixer
 E Batidora de mano



LUND

INCLUDED / ZESTAW ZAWIERA:

- ✓ Blender 700 W / Blender 700 W
- ✓ Stainless steel blade / Ostrze ze stali nierdzewnej
- ✓ Cup 0.5 l / Pojemnik 0.5 l
- ✓ Stainless steel whisk / Trzepaczka ze stali nierdzewnej
- ✓ Chopper 0.5 l with stainless steel blade / Malakser 0.5 l z ostrzem ze stali nierdzewnej

- ✓ BPA free tritan bottle 0.6 l with blade and cap / Butelka 0.6 l wolna od BPA wykonana z tritanu z ostrzem i zakrętką
- ✓ Holder for blade and whisk / Podstawa na ostrze i trzepaczkę

No.	W	
67700	700	6

PL Blender kielichowy do smoothie
 GB Smoothie blender
 D Standmixer
 RUS Блендер

CZ Smoothie mixér
 RO Smoothie blender
 H Smoothie turmixgép
 E Batidora smoothie



LUND

No.	W	
67702	300	6

INCLUDED / ZESTAW ZAWIERA:

- ✓ Blender 300 W
- ✓ Stainless steel blade / Ostrze ze stali nierdzewnej
- ✓ Jar 1 l / Kielich 1 l
- ✓ Bottle 0.57 l / Butelka 0.57 l
- ✓ Bottle 0.4 l / Butelka 0.4 l

PL Blender kielichowy do smoothie
 GB Smoothie blender
 D Standmixer
 RUS Блендер

CZ Smoothie mixer
 RO Smoothie blender
 H Smoothie turmixgép
 E Batidora smoothie



- INCLUDED / ZESTAW ZAWIERA:**
- ✓ Blender 500 W
 - ✓ Stainless steel blade / Ostrze ze stali nierdzewnej
 - ✓ Glass jar 0.6 l / Szklany kielich 0.6 l
 - ✓ Bottle 0.57 l / Butelka 0.57 l
 - ✓ Bottle 0.4 l / Butelka 0.4 l
 - ✓ Grinder / Młynek

LUND

No.	W	
67703	500	4

PL Blender kielichowy
 GB Stand blender
 D Standmixer
 RUS Блендер

CZ Stólní mixér
 RO Blender
 H Turmixgép
 E Batidora de vaso



PL Blender kielichowy
 GB Stand blender
 D Standmixer
 RUS Блендер

CZ Stólní mixér
 RO Blender
 H Turmixgép
 E Batidora de vaso



LUND

- INCLUDED / ZESTAW ZAWIERA:**
- ✓ Blender 600 W
 - ✓ Stainless steel blade / Ostrze ze stali nierdzewnej
 - ✓ Jar 1.5 l / Kielich 1.5 l



BLADE / OSTRZE

No.	W	
67705	600	4

PL Wyciskarka wolnoobrotowa do soków
 GB Slow juicer
 D Langsam laufende Saftpresse
 RUS Соковыжималка шнековая

CZ Nízkootáčkový odšťavňovač
 RO Storicator de fructe
 H Gyümölcscentrifuga
 E Saca jugo

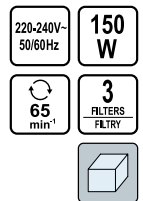

LUND

- FEATURES / CECHY:**
- ✓ Prepares fruit and vegetable juices, mousses, ice creams, dairy cocktails / Możliwość przygotowania soków owocowych i warzywnych, przecierów, lodów i koktajli mlecznych
 - ✓ Keep more nutrition and original taste than in traditional juicers / Zachowuje więcej witamin i smaku niż w tradycyjnej sokowirówce
 - ✓ Reverse gear / Bieg wsteczny
 - ✓ Dishwasher-safe for a quick and easy clean up / Szybkie i łatwe czyszczenie - możliwość mycia w zmywarce
 - ✓ Anti-drip cap / Korek niekapek
 - ✓ Skid-resistant feet / Nóżki antypoślizgowe
 - ✓ Comfortable handle / Wygodna rączka do przenoszenia
 - ✓ Low noise <60db / Cicha praca <60db



2x JUICE & PULP JUIGS 1L / POJEMNIKI NA SOK I NA PULPE 1L



CLEANING BRUSH / SZCZOTECZKA DO CZYSZCZENIA



JUICE STRAINER / FILTR DO RZADKIEGO SOKU



ICE CREAM STRAINER / FILTR DO LODOW



COARSE STRAINER / FILTR DO GĘSTEGO SOKU

LUND

No.	W	
67704	800	4

No.	W	
67840	150	2

- PL Wyciskarka wolnoobrotowa do soków
- GB Slow juicer
- D Langsam laufende Saftpresse
- RUS Соковыжималка шнековая
- CZ Nízkootáčkový odšťavňovač
- RO Storcător de fructe
- H Gyümölcscentrifuga
- E Saca jugo

220-240V-50/60Hz	150 W
65 min ⁻¹	3 FILTERS FILTRY
Ø 75 mm	SS STAINLESS STEEL STAL NIERDZEWNA
	



FEATURES / CECHY:

- ✓ Prepares fruit and vegetable juices, mousses, ice creams, dairy cocktails / Możliwość przygotowania soków owocowych i warzywnych, przecierów, lodów i koktajli mlecznych
- ✓ Keep more nutrition and original taste than in traditional juicers / Zachowuje więcej witamin i smaku niż w tradycyjnej sokowirówce
- ✓ Reverse gear / Bieg wsteczny
- ✓ Dishwasher-safe for a quick and easy clean up / Szybkie i łatwe czyszczenie - możliwość mycia w zmywarce
- ✓ Anti-drip cap / Korek niekapek
- ✓ Skid-resistant feet / Nóżki antypoślizgowe
- ✓ Comfortable handle / Wygodna rączka do przenoszenia
- ✓ Low noise <60db / Cicha praca <60db



JUICE & PULP JUGS 1L / POJEMNIKI NA SOK I NA PULPĘ 1L



CLEANING BRUSH / SZCZOTECZKA DO CZYSZCZENIA



JUICE STRAINER / FILTR DO RZADKIEGO SOKU



ICE CREAM STRAINER / FILTR DO LODÓW



COARSE STRAINER / FILTR DO GĘSTEGO SOKU



LUND

No.	W	
67841	150	2

- PL Sokowirówka
- GB Juicer
- D Entsafter
- RUS Соковыжималка
- CZ Odšťavňovač
- RO Storcător
- H Gyümölcscentrifuga
- E Licuadora



220-240V-50/60Hz	800 W
x2 SPEEDS PREDKOSCI	15000 min⁻¹
Ø 75 mm	ANTI-DROP CUP NIEKAPACY WYLOT
x4 SUCTION PADS PRZYSAWKI	SS STAINLESS STEEL STAL NIERDZEWNA
	



BOWL COVER Ø 75 mm
DUŻY OTWÓR Ø 75 mm



STAINLESS STEEL GRATER
TARCZA ZE STALI NIERDZEWNEJ



STAINLESS STEEL HOUSING
OBUDOWA ZE STALI NIERDZEWNEJ



JUICE CUP 0.7 l
POJEMNIK NA SOK 0.7 l



WASTE CONTAINER 1.7 l
KOSZ NA ODPADY 1.7 l



LUND

No.	W	
67853	800	2

- PL Sokowirówka
- GB Juicer
- D Entsafter
- RUS Соковыжималка
- CZ Odšťavňovač
- RO Storcător
- H Gyümölcscentrifuga
- E Licuadora

230V~50Hz	600 W
15000 min ⁻¹	2 SPEEDS PREDKOSCI
Ø 68 mm	



BOWL COVER Ø 68 mm
DUŻY OTWÓR Ø 68 mm



STAINLESS STEEL GRATER
TARCZA ZE STALI NIERDZEWNEJ



STEEL HOUSING
METALOWA OBUDOWA



JUICE CUP 0.5 l
POJEMNIK NA SOK 0.5 l



WASTE CONTAINER 1.5 l
KOSZ NA ODPADY 1.5 l

LUND

No.	W	
67850	600	4

- PL Maszynka do mielenia mięsa
- GB Meat mincer
- D Fleischwolf
- RUS Мясорубка
- CZ Mlýnek na maso
- RO Masina de tocat
- H Húsdaráló
- E Picadora de carne

220-240V-50Hz	550 W
5 in 1 5w1	 1.5 kg / min
REVERSE GEAR BIEG WSTECZNY	SS STAINLESS STEEL STAL NIERDZEWNA
	



LUND



STAINLESS STEEL BLADE
OSTRZE ZE STALI NIERDZEWNEJ



METAL FEEDING TRAY /
METALOWA TACKA



SHREDDING INSERTS / WKŁADKI
DO TARCIA I SZATKOWANIA



SAUSAGE FILLER /
NASADKA DO NAPELNIANIA
KIEŁBAS



KEBAB MAKER /
NASADKA DO KEBBE



TOMATO JUICER /
WYCISKARKA DO POMIDORÓW

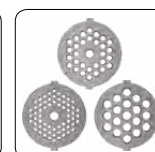

MINCER SCREWS /
TARCZE DO MIELENIA



FOOD PUSHER /
POPYCHACZ

No.	W	
67900	550	4

PL Maszynka do mielenia mięsa
 GB Meat mincer
 D Fleischwolf
 RUS Мясорубка

CZ Mlýnek na maso
 RO Masina de tocat
 H Húsdaráló
 E Picadora de carne



LUND



No.	W	☐
67901	1200	2

PL Czajnik elektryczny
 GB Electric kettle
 D Wasserkocher
 RUS Электрический чайник

CZ Rychlovarná konvice
 RO Fierbator electric
 H Elektromos vízforraló
 E Hervidor eléctrico

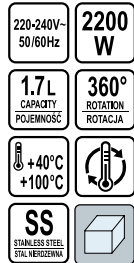

LUND

- FEATURES: / CECHY:**
- ✓ Automatic switch off / Automatyczne wyłączenie po zagotowaniu wody
 - ✓ Boil-dry protection / Ochrona przed przegrzaniem
 - ✓ Cable storage / Możliwość zwinięcia kabla pod podstawką
 - ✓ Cable length 80 cm / Długość kabla 80 cm
 - ✓ Stainless steel housing / Obudowa ze stali nierdzewnej
 - ✓ Temperature control 40-100° (40°-50°-60°-70°-80°-90°-100°) / Regulacja temperatury 40-100° (40°-50°-60°-70°-80°-90°-100°)
 - ✓ Keep warm / Funkcja utrzymywania temperatury



No.	W	☐
68173	2200	8

PL Czajnik elektryczny
 GB Electric kettle
 D Wasserkocher
 RUS Электрический чайник

CZ Rychlovarná konvice
 RO Fierbator electric
 H Elektromos vízforraló
 E Hervidor eléctrico

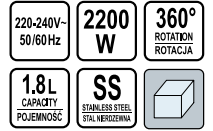

LUND

- FEATURES: / CECHY:**
- ✓ Automatic switch off / Automatyczne wyłączenie po zagotowaniu wody
 - ✓ Boil-dry protection / Ochrona przed przegrzaniem
 - ✓ Removable and washable filter / Filtr z możliwością wyjęcia i umycia
 - ✓ Cable storage / Możliwość zwinięcia kabla pod podstawką
 - ✓ Cable length 80 cm / Długość kabla 80 cm
 - ✓ Stainless steel housing / Obudowa ze stali nierdzewnej



No.	W	☐
68172	2200	8

PL Czajnik elektryczny
 GB Electric kettle
 D Wasserkocher
 RUS Электрический чайник

CZ Rychlovarná konvice
 RO Fierbator electric
 H Elektromos vízforraló
 E Hervidor eléctrico

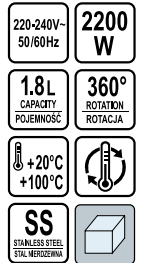

LUND

- FEATURES: / CECHY:**
- ✓ Automatic switch off / Automatyczne wyłączenie po zagotowaniu wody
 - ✓ Boil-dry protection / Ochrona przed przegrzaniem
 - ✓ Removable and washable filter / Filtr z możliwością wyjęcia i umycia
 - ✓ Cable length 75 cm / Długość kabla 75 cm
 - ✓ Stainless steel housing / Obudowa ze stali nierdzewnej
 - ✓ Temperature control 20-100° (20°-25°-30°-...-95°-100°) / Regulacja temperatury 20-100° (20°-25°-30°-...-95°-100°)
 - ✓ Removable and washable filter / Filtr z możliwością wyjęcia i umycia
 - ✓ Keep warm / Funkcja utrzymywania temperatury



No.	W	☐
68174	2200	6

PL Czajnik elektryczny
GB Electric kettle
D Wasserkocher
RUS Электрический чайник

CZ Rychlovarná konvice
RO Fierbator electric
H Elektromos vízforraló
E Hervidor eléctrico

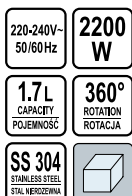

FEATURES: / CECHY:

- ✓ Automatic switch off / Automatykne wyłączenie po zagotowaniu wody
- ✓ Boil-dry protection / Ochrona przed przegrzaniem
- ✓ Removable and washable filter / Filtr z możliwością wyjęcia i umycia
- ✓ Cable storage / Możliwość zwinięcia kabla pod podstawką
- ✓ Cable length 70cm / Długość kabla 70cm
- ✓ Water gauge / Wskaźnik poziomu wody
- ✓ Stainless steel 304 heating plate and body / Płyta grzewcza oraz obudowa ze stali nierdzewnej 304

LUND

No.	W	
68193	2200	4

PL Czajnik elektryczny
GB Electric kettle
D Wasserkocher
RUS Электрический чайник

CZ Rychlovarná konvice
RO Fierbator electric
H Elektromos vízforraló
E Hervidor eléctrico



FEATURES: / CECHY:

- ✓ Automatic switch off / Automatykne wyłączenie po zagotowaniu wody
- ✓ Boil-dry protection / Ochrona przed przegrzaniem
- ✓ Removable and washable filter / Filtr z możliwością wyjęcia i umycia
- ✓ Cable storage / Możliwość zwinięcia kabla pod podstawką
- ✓ Cable length 70cm / Długość kabla 70cm
- ✓ Water gauge / Wskaźnik poziomu wody
- ✓ Stainless steel 304 heating plate and body / Płyta grzewcza oraz obudowa ze stali nierdzewnej 304
- ✓ Temperature control (40-45-50....95-100) / Regulacja temperatury (40-45-50....95-100)
- ✓ Keep warm / Funkcja utrzymywania temperatury

LUND



No.	W	
68195	2200	8

PL Czajnik elektryczny
GB Electric kettle
D Wasserkocher
RUS Электрический чайник

CZ Rychlovarná konvice
RO Fierbator electric
H Elektromos vízforraló
E Hervidor eléctrico

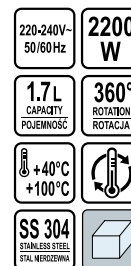

LUND

FEATURES: / CECHY:

- ✓ Automatic switch off / Automatykne wyłączenie po zagotowaniu wody
- ✓ Boil-dry protection / Ochrona przed przegrzaniem
- ✓ Removable and washable filter / Filtr z możliwością wyjęcia i umycia
- ✓ Cable storage / Możliwość zwinięcia kabla pod podstawką
- ✓ Cable length 70cm / Długość kabla 70cm
- ✓ Water gauge / Wskaźnik poziomu wody
- ✓ Stainless steel 304 heating plate and body / Płyta grzewcza oraz obudowa ze stali nierdzewnej 304
- ✓ Temperature control (40-45-50....95-100) / Regulacja temperatury (40-45-50....95-100)
- ✓ Keep warm / Funkcja utrzymywania temperatury

No.	W	
68194	2200	8

PL Młynek do kawy
GB Coffee grinder
D Kaffeemühle
RUS Кофемолка

CZ Mlýnek na kávu
RO Rajnita cafea
H Kávédaráló
E Molino de café



GRINDING / MIELENIE:

- ✓ Coffee / Kawy
- ✓ Nuts / Orzechów
- ✓ Herbs / Ziół
- ✓ Grains / Ziaren
- ✓ Spices / Przypraw



GRINDING BLADE / OSTRZE DO MIELENIA

LUND

No.	W	
68480	150	18

PL Młynek do kawy CZ Młynek na kávu
 GB Coffee grinder RO Rajnita cafea
 D Kaffeemühle H Kávédaráló
 RUS Кофемолка E Molino de café



GRINDING / MIELENIE:

- ✓ Coffee / Kawy
- ✓ Nuts / Orzechów
- ✓ Herbs / Ziół
- ✓ Grains / Ziaren
- ✓ Spices / Przypraw



GRINDING BLADE / OSTRZE DO MIELENIA



CABLE STORAGE / MOŻLIWOŚĆ ZWINIENIA KABLA POD PODSTAWKĄ

LUND

No.	W	Icon
68481	150	18

PL Frytkownica beztłuszczowa CZ Horkovzdusná fritéza
 GB Air fryer RO Friteuză
 D Heißluftfritteuse H Olajsütő olaj nélküli
 RUS Фритюрница E Freidora sin aceite

FUNCTIONS / FUNKCJE:

- ✓ Defrost / Rozmraża
- ✓ Reheat / Podgrzewa
- ✓ Bake / Piecze
- ✓ Fry / Smaży
- ✓ Grill / Grilluje



LUND



FEATURES / CECHY:

- ✓ Up to 80% less oil than in conventional fryer / Nawet 80% mniej oleju niż w standardowej frytkownicy
- ✓ Easy to use - timer and temperature control / Łatwa, intuicyjna obsługa dzięki regulacji temperatury i czasu
- ✓ Dishwasher safe for a quick and easy clean up / Szybkie i łatwe czyszczenie - możliwość mycia w zmywarce
- ✓ Faster heating up than in traditional oven / Szybsze nagrzewanie niż w tradycyjnym piekarniku
- ✓ Preparation: fries, meat, fish, vegetables, cakes and more / Przygotowanie m.in. frytek, mięsa, ryb, warzyw, ciastek

No.	W	Icon
67571	1300	2

PL Frytkownica beztłuszczowa
 GB Air fryer
 D Heißluftfritteuse
 RUS Фритюрница
 CZ Horkovzdusná fritéza
 RO Friteuză
 H Olajsütő olaj nélküli
 E Freidora sin aceite

FUNCTIONS / FUNKCJE:

- ✓ Defrost / Rozmraża
- ✓ Reheat / Podgrzewa
- ✓ Bake / Piecze
- ✓ Fry / Smaży
- ✓ Grill / Grilluje



LUND



FEATURES / CECHY:

- ✓ Up to 80% less oil than in conventional fryer / Nawet 80% mniej oleju niż w standardowej frytkownicy
- ✓ Easy to use - timer and temperature control / Łatwa, intuicyjna obsługa dzięki regulacji temperatury i czasu
- ✓ Dishwasher safe for a quick and easy clean up / Szybkie i łatwe czyszczenie - możliwość mycia w zmywarce
- ✓ Faster heating up than in traditional oven / Szybsze nagrzewanie niż w tradycyjnym piekarniku
- ✓ Preparation: fries, meat, fish, vegetables, cakes and more / Przygotowanie m.in. frytek, mięsa, ryb, warzyw, ciastek

No.	W	Icon
67570	1300	2

PL Frytkownica beztłuszczowa CZ Horkovzdusná fritéza
 GB Air fryer RO Friteuză
 D Heißluftfritteuse H Olajsütő olaj nélküli
 RUS Фритюрница E Freidora sin aceite



BREAD PAN / RONDEL DO PIECZENIA CHLEBA



PIZZA PAN / PATELŃIA DO PIZZY



FOOD DIVIDER / PRZEGRODA DO POTRAW



LUND



FEATURES / CECHY:

- ✓ Up to 80% less oil than in conventional fryer / Nawet 80% mniej oleju niż w standardowej frytkownicy
- ✓ Easy to use - timer and temperature control / Łatwa, intuicyjna obsługa dzięki regulacji temperatury i czasu
- ✓ Dishwasher safe for a quick and easy clean up / Szybkie i łatwe czyszczenie - możliwość mycia w zmywarce
- ✓ Faster heating up than in traditional oven / Szybsze nagrzewanie niż w tradycyjnym piekarniku
- ✓ Preparation: fries, meat, fish, vegetables, cakes and more / Przygotowanie m.in. frytek, mięsa, ryb, warzyw, ciastek

No.	W	Icon
67572	1400	2

PL Frytkownica beztłuszczowa
 GB Air fryer
 D Heißluftfritteuse
 RUS Фритюрница
 CZ Horkovzdušná fritéza
 RO Friteuză
 H Olajsütő olaj nélküli
 E Freidora sin aceite

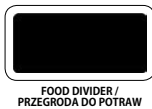

FOOD DIVIDER / PRZEGRODKA DO POTRAW



220-240V-50/60Hz	1800 W
0-30 min	5.2 L BASKET CAPACITY POJEMNOŚĆ KOSZA
+80°C +200°C	NON-STICK COATING NIEPRZYMERLAJĄCA POWŁOKA
DISHWASHER SAFE MOŻLIWOŚĆ MYCIA W ZMYWARCE	

LUND



FEATURES / CECHY:

- ✓ Up to 80% less oil than in conventional fryer / Nawet 80% mniej oleju niż w standardowej frytkownicy
- ✓ Easy to use - timer and temperature control / Łatwa, intuicyjna obsługa dzięki regulacji temperatury i czasu
- ✓ Dishwasher safe for a quick and easy clean up / Szybkie i łatwe czyszczenie - możliwość mycia w zmywarce
- ✓ Faster heating up than in traditional oven / Szybsze nagrzewanie niż w tradycyjnym piekarniku
- ✓ Preparation: fries, meat, fish, vegetables, cakes and more / Przygotowanie m.in. frytek, mięsa, ryb, warzyw, ciastek

No.	W	
67573	1800	2

PL Piekarnik elektryczny
 GB Mini oven
 D Mini ofen
 RUS Электрическая духовка

CZ Mini trouba
 RO Cuptor electric
 H Mini sütő
 E Horno de sobremesa

220-240V-50/60Hz	1600 W
28 L CAPACITY POJEMNOŚĆ	230°C max.
0-60 min	

FUNCTIONS / FUNKCJE:

- ✓ Temperature control / Regulacja temperatury
- ✓ Heating mode / Tryb grzania
- ✓ Convection and rotisserie control / Regulacja termoobiegu i różna
- ✓ Timer / Regulator czasowy



LUND

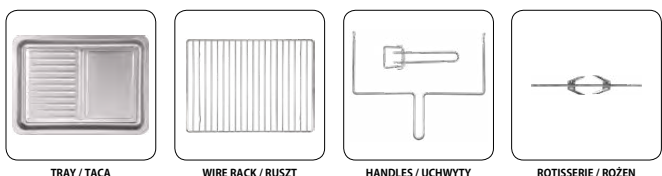

TRAY / TACA

WIRE RACK / RUSZT

HANDLES / UCHWYTY

ROTISSERIE / ROŻEN

No.	W	
68050	1600	1

PL Frytkownica beztłuszczowa
 GB Air fryer
 D Heißluftfritteuse
 RUS Фритюрница
 CZ Horkovzdušná fritéza
 RO Friteuză
 H Olajsütő olaj nélküli
 E Freidora sin aceite



BREAD PAN / RONDEL DO PIECZENIA CHLEBA



PIZZA PAN / PATELNIĄ DO PIZZY



FOOD DIVIDER / PRZEGRODKA DO POTRAW

220-240V-50/60Hz	1800 W
0-60 min	5.2 L BASKET CAPACITY POJEMNOŚĆ KOSZA
+80°C +200°C	NON-STICK COATING NIEPRZYMERLAJĄCA POWŁOKA
DISHWASHER SAFE MOŻLIWOŚĆ MYCIA W ZMYWARCE	7 PROGRAMS PROGRAMÓW
LCD DISPLAY WYŚWIETLACZ	

LUND



FEATURES / CECHY:

- ✓ Up to 80% less oil than in conventional fryer / Nawet 80% mniej oleju niż w standardowej frytkownicy
- ✓ Easy to use - timer and temperature control / Łatwa, intuicyjna obsługa dzięki regulacji temperatury i czasu
- ✓ Dishwasher safe for a quick and easy clean up / Szybkie i łatwe czyszczenie - możliwość mycia w zmywarce
- ✓ Faster heating up than in traditional oven / Szybsze nagrzewanie niż w tradycyjnym piekarniku
- ✓ Preparation: fries, meat, fish, vegetables, cakes and more / Przygotowanie m.in. frytek, mięsa, ryb, warzyw, ciastek

No.	W	
67574	1800	2

PL Piekarnik elektryczny
 GB Mini oven
 D Mini ofen
 RUS Электрическая духовка

CZ Mini trouba
 RO Cuptor electric
 H Mini sütő
 E Horno de sobremesa

220-240V-50/60Hz	2000 W
38 L CAPACITY POJEMNOŚĆ	230°C max.
0-60 min	

FUNCTIONS / FUNKCJE:

- ✓ Temperature control / Regulacja temperatury
- ✓ Heating mode / Tryb grzania
- ✓ Convection and rotisserie control / Regulacja termoobiegu i różna
- ✓ Timer / Regulator czasowy



LUND

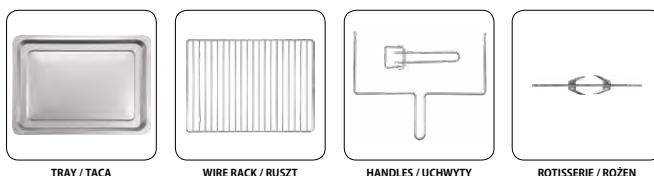

TRAY / TACA

WIRE RACK / RUSZT

HANDLES / UCHWYTY

ROTISSERIE / ROŻEN

No.	W	
68051	2000	1

PL Piekarnik elektryczny CZ Mini trouba
 GB Mini oven RO Cuptor electric
 D Mini ofen H Mini sütő
 RUS Электрическая духовка E Horno de sobremesa

FUNCTIONS / FUNKCJE:

- ✓ Temperature control / Regulacja temperatury
- ✓ Heating mode / Tryb grzania
- ✓ Convection and rotisserie control / Regulacja termoobiegu i różna
- ✓ Timer / Regulator czasowy



LUND

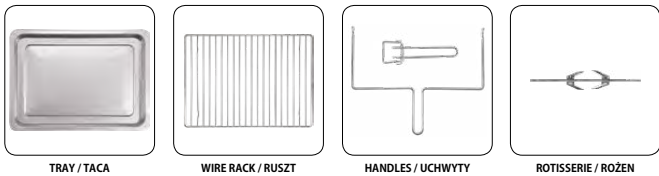

No.	W	
68052	2000	1

PL Kombiwar halogenowy CZ Halogenová trouba
 GB Halogen oven RO Halogen cuptor
 D Halogenofen H Halogén sütő
 RUS Галогеновая печь E Horno halogeno

FUNCTIONS / FUNKCJE:

- ✓ Thaw / Odmraża
- ✓ Reheat / Podgrzewa
- ✓ Bake / Piecze
- ✓ Grill / Grilluje
- ✓ Broil / Opieka
- ✓ Cook / Gotuje
- ✓ Steam / Gotuje na parze



ACCESSORIES / AKCESORIA:

- ✓ tongs / szczypsc
- ✓ bread rack / stojak na chleb



LID HOLDER / STOJAK NA POKRYWE

HIGH RACK / GÓRNY RUSZT



EXTENDER RING / PIERSCIEN

LOW RACK / DOLNY RUSZT

ALUMINIUM STEAMER / ALUMINIOWY PAROWAR

FRYING PAN / PATELNIJA

FEATURES / CECHY:

- ✓ Cooking time is 3 to 5 times faster than in conventional ovens / Od 3 do 5 razy szybszy proces gotowania w porównaniu do tradycyjnych piekarników
- ✓ Cooking without fats or oil / Beztłuszczowe gotowanie bez oleju
- ✓ Safe tempered glass body / Bezpieczne, hartowane szkło
- ✓ Low usage of electricity / Niskie zużycie energii elektrycznej
- ✓ Excellent turbo wash function for self-cleaning / Skuteczna funkcja autoczyszczenia misy
- ✓ Easy operation with timer and temperature control / Łatwa, intuicyjna obsługa dzięki regulacji temperatury i czasu
- ✓ Evenly cooked foods (convection) / Równomierne gotowanie potraw (termoobieg)

LUND

No.	W	
67640	1400	2

PL Piekarnik elektryczny CZ Mini trouba
 GB Mini oven RO Cuptor electric
 D Mini ofen H Mini sütő
 RUS Электрическая духовка E Horno de sobremesa

FUNCTIONS / FUNKCJE:

- ✓ Temperature control / Regulacja temperatury
- ✓ Heating mode / Tryb grzania
- ✓ Convection and rotisserie control / Regulacja termoobiegu i różna
- ✓ Timer / Regulator czasowy



LUND

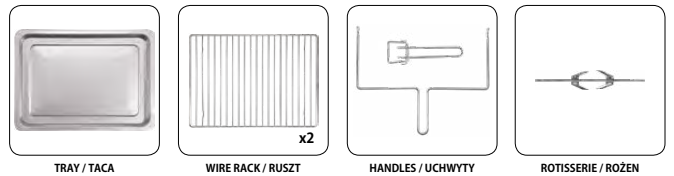

No.	W	
68053	2000	1

PL Kombiwar halogenowy CZ Halogenová trouba
 GB Halogen oven RO Halogen cuptor
 D Halogenofen H Halogén sütő
 RUS Галогеновая печь E Horno halogeno

FUNCTIONS / FUNKCJE:

- ✓ Thaw / Odmraża
- ✓ Reheat / Podgrzewa
- ✓ Bake / Piecze
- ✓ Grill / Grilluje
- ✓ Broil / Opieka
- ✓ Cook / Gotuje
- ✓ Steam / Gotuje na parze



ACCESSORIES / AKCESORIA:

- ✓ tongs / szczypsc
- ✓ bread rack / stojak na chleb



LID HOLDER / STOJAK NA POKRYWE

HIGH RACK / GÓRNY RUSZT

FEATURES / CECHY:

- ✓ Cooking time is 3 to 5 times faster than in conventional ovens / Od 3 do 5 razy szybszy proces gotowania w porównaniu do tradycyjnych piekarników
- ✓ Cooking without fats or oil / Beztłuszczowe gotowanie bez oleju
- ✓ Safe tempered glass body / Bezpieczne, hartowane szkło
- ✓ Low usage of electricity / Niskie zużycie energii elektrycznej
- ✓ Excellent turbo wash function for self-cleaning / Skuteczna funkcja autoczyszczenia misy
- ✓ Easy operation with timer and temperature control / Łatwa, intuicyjna obsługa dzięki regulacji temperatury i czasu
- ✓ Evenly cooked foods (convection) / Równomierne gotowanie potraw (termoobieg)

LUND

No.	W	
67641	1400	2

PL Suszarka spożywcza
 GB Food dehydrator
 D Lebensmittelrockner
 RUS Сушилка для пищевых продуктов

CZ Sušička potravin
 RO Deshidrator alimente
 H Ételszáritó
 E Secador de alimentos

220-240V-50-60Hz
500 W

31x29.5cm
 TRAY AREA
 POWIERZCHNIA SIT

+35°C
 +70°C

5 TRAYS / SIT



DRIES:
 ✓ fruit, vegetables, flowers, mushrooms, herbs, meat and much more

SUSZY:
 ✓ owoce, warzywa, kwiaty, grzyby, ziola mięso i wiele więcej

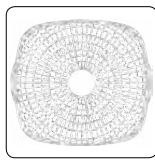

TRANSPARENT DRYING TRAYS / PRZECZYSTE SITA



HOT AIR CIRCULATION SYSTEM / SYSTEM CYRKULACJI GORĄCEGO POWIETRZA

LUND

No.	W	
68270	500	4

PL Suszarka spożywcza
 GB Food dehydrator
 D Lebensmittelrockner
 RUS Сушилка для пищевых продуктов

CZ Sušička potravin
 RO Deshidrator alimente
 H Ételszáritó
 E Secador de alimentos

220-240V-50-60Hz
500 W

32.5x30cm
 TRAY AREA
 POWIERZCHNIA SIT

+35°C
 +70°C

0.5-19.5h
6 TRAYS / SIT

DRIES:
 ✓ fruit, vegetables, flowers, mushrooms, herbs, meat and much more

SUSZY:
 ✓ owoce, warzywa, kwiaty, grzyby, ziola mięso i wiele więcej



LUND

DIGITAL CONTROL PANEL / CYFROWY PANEL STEROWANIA

STAINLESS STEEL TRAYS / SITA ZE STALI NIERDZEWNEJ

MESH SHEET AND SOLID SHEET / SIATKA I TACKA

HOT AIR CIRCULATION SYSTEM / SYSTEM CYRKULACJI GORĄCEGO POWIETRZA

No.	W	
68272	500	2

PL Suszarka spożywcza
 GB Food dehydrator
 D Lebensmittelrockner
 RUS Сушилка для пищевых продуктов

CZ Sušička potravin
 RO Deshidrator alimente
 H Ételszáritó
 E Secador de alimentos

220-240V-50-60Hz
500 W

31x29.5cm
 TRAY AREA
 POWIERZCHNIA SIT

+35°C
 +70°C

0.5-19.5h
5 TRAYS / SIT



DRIES:
 ✓ fruit, vegetables, flowers, mushrooms, herbs, meat and much more

SUSZY:
 ✓ owoce, warzywa, kwiaty, grzyby, ziola mięso i wiele więcej

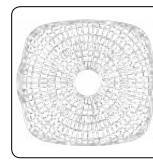

TRANSPARENT DRYING TRAYS / PRZECZYSTE SITA



HOT AIR CIRCULATION SYSTEM / SYSTEM CYRKULACJI GORĄCEGO POWIETRZA



DIGITAL CONTROL PANEL / CYFROWY PANEL STEROWANIA

LUND

No.	W	
68271	500	4

PL Suszarka spożywcza
 GB Food dehydrator
 D Lebensmittelrockner
 RUS Сушилка для пищевых продуктов

CZ Sušička potravin
 RO Deshidrator alimente
 H Ételszáritó
 E Secador de alimentos

220-240V-50-60Hz
700 W

32.5x30cm
 TRAY AREA
 POWIERZCHNIA SIT

+35°C
 +70°C

0.5-19.5h
9 TRAYS / SIT

DRIES:
 ✓ fruit, vegetables, flowers, mushrooms, herbs, meat and much more

SUSZY:
 ✓ owoce, warzywa, kwiaty, grzyby, ziola mięso i wiele więcej



LUND

DIGITAL CONTROL PANEL / CYFROWY PANEL STEROWANIA

STAINLESS STEEL TRAYS / SITA ZE STALI NIERDZEWNEJ

MESH SHEET AND SOLID SHEET / SIATKA I TACKA

HOT AIR CIRCULATION SYSTEM / SYSTEM CYRKULACJI GORĄCEGO POWIETRZA

No.	W	
68273	700	1

PL Wolnowar z czasomierzem CZ Pomaly hrnec
 GB Slow cooker RO Oala galit cu abur
 D Schongarer H Lassúfőző edény
 RUS Медленноварка E Olla de cocción lenta

FUNCTIONS / FUNKCJE:
 ✓ Low temperature / Niska temperatura
 ✓ High temperature / Wysoka temperatura
 ✓ Keep warm / Podtrzymywanie ciepła

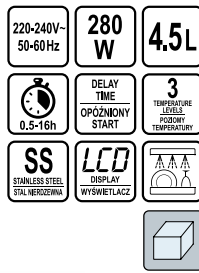

LUND



REMOVABLE CERAMIC POT 4.5L / WYJMOWALNA CERAMICZNA MISA
 DIGITAL CONTROL PANEL / CYFROWY PANEL STEROWANIA
 COOL TOUCH HANDLES / CHŁODNE UCHWYTY
 TEMPERED GLASS LID / POKRYWA Z HARTOWANEGO SZKŁA

No.	W	Box
67660	280	2

PL Toster CZ Opékač topinek
 GB Toaster RO Aparat de prajit paine
 D Toaster H Kenyérpirító
 RUS Тостер E Tostadora



CRUMBS TRAY / TACKA NA OKRUCHY
 7-DEGREE HEATING LEVEL / 7 POZIOMÓW OPIEKANIA

LUND

No.	W	Box
67500	850	6

PL Wolnowar CZ Pomaly hrnec
 GB Slow cooker RO Oala galit cu abur
 D Schongarer H Lassúfőző edény
 RUS Медленноварка E Olla de cocción lenta

FUNCTIONS / FUNKCJE:
 ✓ Low temperature / Niska temperatura
 ✓ High temperature / Wysoka temperatura
 ✓ Keep warm / Podtrzymywanie ciepła

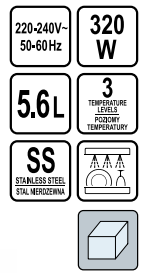

LUND



REMOVABLE CERAMIC POT 5.6L / WYJMOWALNA CERAMICZNA MISA
 CONTROL PANEL / PANEL STEROWANIA
 COOL TOUCH HANDLES / CHŁODNE UCHWYTY
 TEMPERED GLASS LID / POKRYWA Z HARTOWANEGO SZKŁA

No.	W	Box
67661	320	2

PL Toster CZ Opékač topinek
 GB Toaster RO Aparat de prajit paine
 D Toaster H Kenyérpirító
 RUS Тостер E Tostadora



CRUMBS TRAY / TACKA NA OKRUCHY
 7-DEGREE HEATING LEVEL / 7 POZIOMÓW OPIEKANIA

LUND

No.	W	Box
67501	1500	4

PL Opiekacz
GB Sandwich maker
D Waffeleisen
RUS Сэндвичница

CZ Sendvičovač
RO Aparat pt. sandwich
H Szendvicsütő
E Gratinador

220-240V-50/60Hz	1400 W	25x21 cm PLATE SIZE ROZMIAR PŁYTY
NON-STICK COATING NEPRZYMERLĄCZA POWŁOKA	4 SLICES KROMKI	



4-SLICE SANDWICH PLATE / PŁYTA NA 4 TOSTY



UPRIGHT STANDING FOR COMPACT STORAGE / MOŻLIWOŚĆ PRZECHYNYWANIA W POZYCJI PIONOWEJ

LUND

No.	W	
67520	1400	4

PL Grill elektryczny
GB Contact grill
D Kontaktgrill
RUS Контактный гриль

CZ Kontaktní gril
RO Gratar electric
H Elektromos grillsütő
E Parrilla de contacto

220-240V-50/60Hz	2000 W	33x24 cm PLATE SIZE ROZMIAR PŁYTY
NON-STICK COATING NEPRZYMERLĄCZA POWŁOKA	TEMPERATURE CONTROL REGULACJA TEMPERATURY	0.95 m



90° OPENING / FUNKCJA ROZKŁADANIA 90°



180° OPENING / FUNKCJA ROZKŁADANIA 180°



FLOATING HINGE SYSTEM / DOPASOWANIE PŁYT GRZEWICZYCH DO WYSOKOŚCI OPIEKANYCH PRODUKTÓW



DETACHABLE PLATES / MOŻLIWOŚĆ WYCIĄGA PŁYT

LUND

No.	W	
67456	2000	3

PL Grill elektryczny
GB Contact grill
D Kontaktgrill
RUS Контактный гриль

CZ Kontaktní gril
RO Gratar electric
H Elektromos grillsütő
E Parrilla de contacto

220-240V-50/60Hz	2200 W	29x23 cm PLATE SIZE ROZMIAR PŁYTY
NON-STICK COATING NEPRZYMERLĄCZA POWŁOKA	TEMPERATURE CONTROL REGULACJA TEMPERATURY	0.8 m



LUND



FLOATING HINGE SYSTEM / DOPASOWANIE PŁYT GRZEWICZYCH DO WYSOKOŚCI OPIEKANYCH PRODUKTÓW



180° OPENING / FUNKCJA ROZKŁADANIA 90°



90° OPENING / FUNKCJA ROZKŁADANIA 90°



DRIP TRAY FOR OIL / TACKA OCIEKOWA NA TŁUSZCZ

No.	W	
67451	2200	3

PL Grill elektryczny
GB Contact grill
D Kontaktgrill
RUS Контактный гриль

CZ Kontaktní gril
RO Gratar electric
H Elektromos grillsütő
E Parrilla de contacto

220-240V-50/60Hz	2000 W	29.5x24 cm PLATE SIZE ROZMIAR PŁYTY
NON-STICK COATING NEPRZYMERLĄCZA POWŁOKA	TEMPERATURE CONTROL REGULACJA TEMPERATURY	30 min TIMER CZASOMIERNIK

0.7 m 	
-----------	--



DRIP TRAY FOR OIL / TACKA OCIEKOWA NA TŁUSZCZ



FLOATING HINGE SYSTEM / DOPASOWANIE PŁYT GRZEWICZYCH DO WYSOKOŚCI OPIEKANYCH PRODUKTÓW



90° OPENING / FUNKCJA ROZKŁADANIA 90°



180° OPENING / FUNKCJA ROZKŁADANIA 180°

LUND

No.	W	
67457	2000	3



- PL Grill stolowy elektryczny CZ Elektryczny stolny grill
 GB Table grill RO Gratar electric
 D Tischgrill H Elektromos asztali grill
 RUS Настольный гриль E Plancha de asar

220-240V~50/60Hz
2000 W
 49x27 cm
 PLATE SIZE /
 ROZMIAR PŁYTY

NON-STICK COATING /
 NIEPRZYMERZAJĄCA
 POWŁOKA

TEMPERATURE CONTROL /
 REGULACJA TEMPERATURY

0.8m

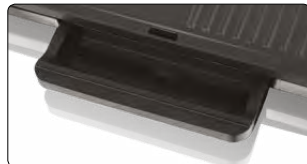
LUND

No.	W	
67453	2000	4

- PL Grill stolowy elektryczny CZ Elektryczny grill
 GB Electric grill RO Gratar electric
 D Elektrogrill H Elektromos grill
 RUS Электрический гриль E Barbacoa eléctrica

220-240V~50/60Hz
2400 W
 47x34 cm
 PLATE SIZE /
 ROZMIAR PŁYTY

82 cm
 PLATE HEIGHT /
 WYSOKOŚĆ
 RUCIŚCI

2.8m





LUND

No.	W	
67420	2400	1



- PL Grill stolowy elektryczny CZ Elektryczny stolny grill
 GB Table grill RO Gratar electric
 D Tischgrill H Elektromos asztali grill
 RUS Настольный гриль E Plancha de asar

220-240V~50Hz
2000 W
 40.5x25 cm
 PLATE SIZE /
 ROZMIAR PŁYTY

NON-STICK COATING /
 NIEPRZYMERZAJĄCA
 POWŁOKA

TEMPERATURE CONTROL /
 REGULACJA TEMPERATURY

0.8m

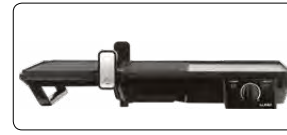
LUND

No.	W	
67455	2000	2

- PL Gofrownica CZ Vaflovač
 GB Waffle maker RO Aparat de preparat waffle
 D Waffeleisen H Gofrsütő
 RUS Вафельница E Gofrera

220-240V~50/60Hz
850 W
 ∅20 cm
 PLATE SIZE /
 ROZMIAR PŁYTY

4 WAFFLES /
 GOFRY

NON-STICK COATING /
 NIEPRZYMERZAJĄCA
 POWŁOKA

TEMPERATURE CONTROL /
 REGULACJA TEMPERATURY



LUND

No.	W	
68011	850	4

- PL Naleśnikarka CZ Plotna na palaćki
 GB Crepe maker RO Aparat pt. clătite
 D Kreppmacher H Palacsintásütő
 RUS Плита для блинов E Crepera elect

220-240V~50/60Hz
 1000 W
 30 cm PLATE DIAMETER ŚREDNICA PŁYTY
 NON-STICK COATING NIEPRZYPIERANIA POWŁOKA
 TEMPERATURE CONTROL REGULACJA TEMPERATURY
 0.8 m



LUND

No.	W	
67470	1000	6

- PL Pakowarka próżniowa CZ Vakuová balička
 GB Vacuum sealer RO Aparat de ambalare in vid
 D Vakuumierer H Vákuum csomagolóhoz
 RUS Вакуумные упаковки E Envasadora al vacio

230V~50Hz
 175 W
 -80 kPa
 28 cm MAX BAG MAX TORBY
 16 l/min
 ADJUSTABLE VACUUM RATE REGULACJA SIŁY SSANIA



BAGS NOT INCLUDED / PRODUKT NIE ZAWIERA WORKÓW W ZESTAWIE



BUTTON PANEL LED PANEL STEROWANIA LED



CABLE STORAGE MIEJSCE NA KABEL



SEALING FUNCTION FUNKCJA ZGRZEWARKI



AUXILIARY OUTLET ZŁĄCZE ZEWNĘTRZNE



ADJUSTABLE VACUUM RATE REGULACJA SIŁY SSANIA

LUND

No.	W	
67882	175	6

- PL Pakowarka próżniowa CZ Vakuová balička
 GB Vacuum sealer RO Aparat de ambalare in vid
 D Vakuumierer H Vákuum csomagolóhoz
 RUS Вакуумные упаковки E Envasadora al vacio

230V~50Hz
 140 W
 -60 kPa
 22 cm MAX BAG MAX TORBY
 11 l/min



BAGS NOT INCLUDED / PRODUKT NIE ZAWIERA WORKÓW W ZESTAWIE



EASY TO USE PROSTY W UŻYCIU



SEALING FUNCTION FUNKCJA ZGRZEWARKI



CABLE STORAGE MIEJSCE NA KABEL

LUND

No.	W	
67880	140	12

- PL Worki moletowane CZ Sáčky moletované
 GB Vacuum bags RO Pungi gofrate
 D Gerändelte Vakuumbutel H Zacsók rovátolt
 RUS Мешки для вакуумной упаковки E Bolsas moleteadas

50 PCS PA/PE
 90 µm



LUND

No.	size / rozmiar (cm)	pcs / packing	µm	for / dla	
67887	20x30	50	90	67880	24
67888	25x35	50	90	67880; 67882	14

- PL Urządzenie do waty cukrowej CZ Výrobník cukrové vaty
 GB Cotton candy maker RO Aparat de facut vata de zahar
 D Zuckerwattemaschine H Vattacukor-készítő
 RUS Сахарная вата кэнди мэйкер E Máquina de algodón de azúcar

220-240V~50/60Hz
 450 W
 x2 SUCTION PADS PRZYSSAWKI
 295 mm



INCLUDED / : W ZESTAWIE
 ✓ 10 sztuk patyczków / 10 pieces of sticks
 ✓ Measuring spoon / Miarka

LUND

No.	W	
68250	450	4

PL Urządzenie do waty cukrowej
 GB Cotton candy maker
 D Zuckervattemaschine
 RUS Сахарная вата кэнди мэйкер

CZ Výrobník cukrové vaty
 RO Aparat de facut vata de zahar
 H Vattacukor-készítő
 E Máquina de algodón de azúcar



INCLUDED / W ZESTAWIE
 ✓ 10 sztuk patyczków / 10 pieces of sticks
 ✓ Measuring spoon / Miarka

LUND

No.	W	
68251	450	8

PL Odkurzacz cyklonowy
 GB Cyclonic vacuum cleaner
 D Zyklonischer Staubsauger
 RUS Циклонный пылесос
 CZ Cyklonový vysavač
 RO Aspirator ciclonic
 H Cyclone porszívó
 E Aspiradora ciclónica

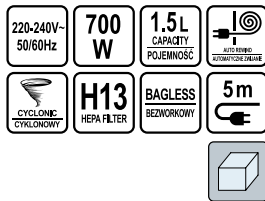

A

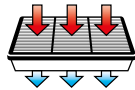

HEPA FILTER H13

LUND



No.	W	
67090*	700	1

PL Urządzenie do popcornu
 GB Popcorn maker
 D Popcorngerät
 RUS Аппарат для попкорна

CZ Zařízení k výrobě popcornu
 RO Aparat de facut popcorn
 H Popcorn gép
 E Máquina de palomitas de maíz



FEATURES / CECHY:
 ✓ Capacity: 50-60 g corn / time
 / Pojemność: 50-60 g ziaren na cykl
 ✓ Without oil / Bez użycia oleju
 ✓ Redy in 3 min. / Gotowe w 3 min.

LUND

No.	W	
68260	1200	6

PL Odkurzacz cyklonowy
 GB Cyclonic vacuum cleaner
 D Zyklonischer Staubsauger
 RUS Циклонный пылесос
 CZ Cyklonový vysavač
 RO Aspirator ciclonic
 H Cyclone porszívó
 E Aspiradora ciclónica

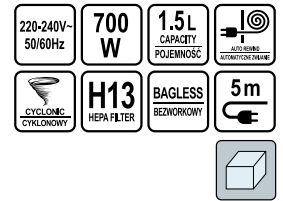

A

LUND



No.	W	
67091*	700	1

- PL Odkurzacz cyklonowy
- GB Cyclonic vacuum cleaner
- D Zyklonischer Staubsauger
- RUS Циклонный пылесос
- CZ Cyklonový vysavač
- RO Aspirator ciclonic
- H Cyclone porszívó
- E Aspiradora ciclónica

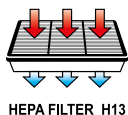

HEPA FILTER H13

220-240V-50/60Hz	700 W	1.5 L CAPACITY / POJEMNOŚĆ	APPLIED ONLINE
CYCLONIC CYKLONOWY	H13 HEPA FILTER	BAGLESS BEZWORONKOWY	5m



A

HOSE / WAŻ	METAL TELESCOPIC TUBE 64 cm / METALOWA, TELESKOPOWA RURA 64 cm	METAL TUBE 24 cm / METALOWA RURA 24 cm
BRUSH FOR FLOOR AND CARPETS / SZCZOTKA DO PODŁÓGI I DYWANÓW	SMALL BRUSH / MAŁA SZCZOTKA	2 IN 1 BRUSH / SZCZOTKA SZCZELINOWA 2 w 1

LUND

No.	W	
67092*	700	1

- PL Pionowy odkurzacz cyklonowy
- GB Cyclonic vacuum cleaner
- D Zyklonischer Staubsauger
- RUS Циклонный пылесос
- CZ Cyklonový vysavač
- RO Aspirator ciclonic
- H Cyclone porszívó
- E Aspiradora ciclónica

220-240V-50Hz	800 W	1.5 L CAPACITY / POJEMNOŚĆ	HEPA FILTER / FILTR HEPA
CYCLONIC CYKLONOWY	BAGLESS BEZWORONKOWY	4.8 m	



CREVICE NOZZLES / KONCÓWKI SZCZELINOWE



ROUND BRUSH / SZCZOTKA Z WŁOSIEM



HOOK / UCHWYT NA SZCZOTKI



SET OF NARROW NOZZLES / ZESTAW WĄSKICH ŚSAWEK



B

BRUSH FOR FLOOR AND CARPETS / SZCZOTKA DO PODŁÓGI I DYWANÓW

TURBO BRUSH / TURBO SZCZOTKA

SMALL BRUSH / MAŁA SZCZOTKA

LUND

No.	W	
67111*	800	4

- PL Odkurzacz cyklonowy
- GB Cyclonic vacuum cleaner
- D Zyklonischer Staubsauger
- RUS Циклонный пылесос
- CZ Cyklonový vysavač
- RO Aspirator ciclonic
- H Cyclone porszívó
- E Aspiradora ciclónica

220-240V-50/60Hz	800 W	1 L CAPACITY / POJEMNOŚĆ	HEPA FILTER / FILTR HEPA
CYCLONIC CYKLONOWY	BAGLESS BEZWORONKOWY	4.8 m	



A

LUND



3 in 1 BRUSH / SZCZOTKA SZCZELINOWA 3 w 1



METAL TELESCOPIC TUBE 70 cm / METALOWA, TELESKOPOWA RURA 70 cm



BRUSH FOR FLOOR AND CARPETS / SZCZOTKA DO PODŁÓGI I DYWANÓW



MOP BRUSH / SZCZOTKA Z MOPEM



WALL MOUNT / UCHWYT NA ŚCIANE

No.	W	
67110*	800	4

- PL Bezprzewodowy odkurzacz pionowy
- GB Rechargeable vacuum cleaner
- D Akku-hand Bodenbürstsauger
- RUS Перезаряжаемый пылесос
- CZ Akumulátorový vysavač
- RO Aspirator reincărcabil
- H Újratölthető porszívó
- E Aspiradora recargable

120 W	22.2 V	2.2 Ah	4-5h CHARGING TIME / CZAS ŁADOWANIA	25-35 min WORK TIME / CZAS PRACY
Li-Ion	CYCLONIC CYKLONOWY	HEPA FILTER / FILTR HEPA	1 L CAPACITY / POJEMNOŚĆ	BAGLESS BEZWORONKOWY



3 in 1 BRUSH / SZCZOTKA SZCZELINOWA 3 w 1



METAL TUBE 66 cm / METALOWA RURA 66 cm



TURBO BRUSH 15 W / TURBO SZCZOTKA 15 W



DOCKING STATION / STACJA DOKUJĄCA



LED BATTERY CHARGE INDICATOR / POZIOM NAŁADOWANIA BATERII

LUND

No.	W	
67120	120	4

PL Filtr do odkurzacza
GB Vacuum cleaner filter
D Staubsaugerfilter
RUS Фильтр для пылесоса

CZ Filtr vysavače
RO Filtru aspirator
H Porszívó szűrő
E Filtro de aspirador



LUND

No.	for / dla	☐
67115	67110; 67120	200
67116	67111	200

PL Myjka parowa
GB Steam cleaner
D Dampfreiniger
RUS Паровой очиститель

CZ Parní čistič
RO Curățător cu aburi
H Gőztisztító
E Limpiador a vapor

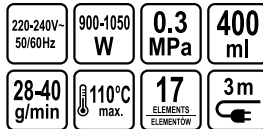

LUND

- ✓ Measuring cup and funnel / Miarka i lejek
- ✓ Microfiber cloth / Nakładka z mikrofibry
- ✓ 55 cm flexible tube / Elastyczna dysza 55 cm
- ✓ 100 cm flexible hose with gun / Elastyczny wąż 100 cm
- ✓ 6 nozzles / 6 końcówek
- ✓ Floor cleaning kit / Zestaw do mycia podłóg
- ✓ Rotary nozzle / Obrotowa dysza
- ✓ Child lock / Zabezpieczenie przed dziećmi
- ✓ Sealed cap / Szczelna zakrętka

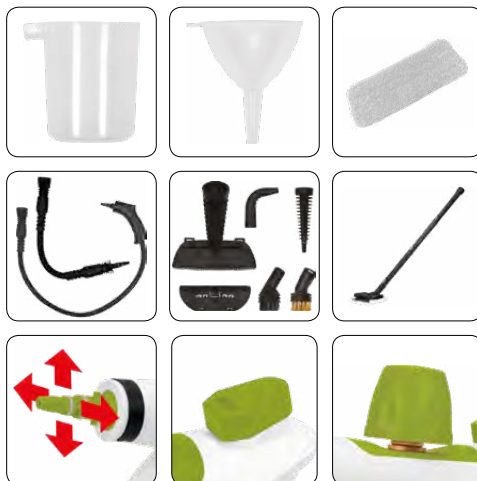

No.	W	☐
67201	900-1050	4

PL Myjka parowa
GB Steam cleaner
D Dampfreiniger
RUS Паровой очиститель
CZ Parní čistič
RO Curățător cu aburi
H Gőztisztító
E Limpiador a vapor

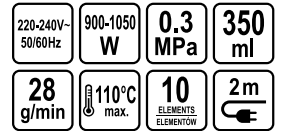

LUND

- ✓ Measuring cup and funnel / Miarka i lejek
- ✓ Microfiber cloth / Nakładka z mikrofibry
- ✓ 55cm flexible tube / Elastyczna dysza 55 cm
- ✓ 6 nozzles / 6 końcówek
- ✓ Rotary nozzle / Obrotowa dysza
- ✓ Child lock / Zabezpieczenie przed dziećmi
- ✓ Sealed cap / Szczelna zakrętka



No.	W	☐
67200	900-1050	6

PL Mop parowy
GB Steam mop
D Dampfmop
RUS Паровая швабра
CZ Parní mop
RO Abur mop
H Gőztisztító mop
E Trapezador a vapor



- ✓ Measuring cup / Miarka
- ✓ 2 x microfiber cloth / 2 x nakładka z mikrofibry
- ✓ 75cm flexible tube / Elastyczny wąż 75cm
- ✓ 8 nozzles / 8 końcówek
- ✓ Carpet glider / Nakładka do dywanów
- ✓ Steam control / Regulacja strumienia pary
- ✓ Rotary head / Obrotowa głowka
- ✓ Comfortable handle / Wygodna rączka

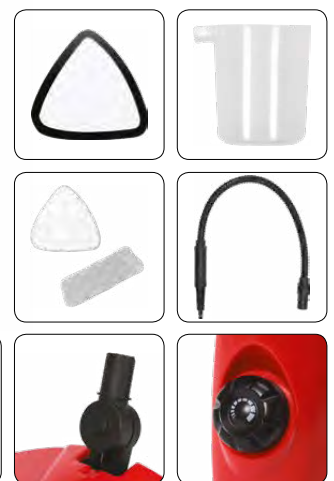

No.	W	☐
67220	1500	4

PL Mop parowy
GB Steam mop
D Dampfmop
RUS Паровая швабра
CZ Parní mop
RO Abur mop
H Gőztisztító mop
E Trapeador a vapor



220-240V-50/60Hz
1500 W
550 ml
10-26 g/min
5m
110°C max.
14 ELEMENTY
UV LAMP / LAMPA

- ✓ Measuring cup / Miarka
- ✓ 2 x microfiber cloth / 2 x nakładka z microfibry
- ✓ 75 cm flexible tube / Elastyczny wąż 75 cm
- ✓ 8 nozzles / 8 końcówek
- ✓ Carpet glider / Nakładka do dywanów
- ✓ UV lamp kills bacteria and germs / Lampa UV zwalcza bakterie i drobnoustroje
- ✓ Steam control / Regulacja strumienia pary
- ✓ Rotary head / Obrotowa głowka
- ✓ Comfortable handle / Wygodna rączka

LUND



No.	W	
67221	1500	4

PL Żelazko turystyczne
GB Travel iron
D Kompakt-Bügeleisen
RUS Туристический утюг

CZ Turistická žehlička
RO Fier de calcat pt calatorii
H Hordozható vasaló
E Plancha de viaje

220-240V-50-60Hz
2800 W
320 ml
CERAMIC SOLEPLATE / CERAMICZNA STOPA
18±3 g/min
23.5x12.5 mm SOLEPLATE SIZE / ROZMIAR STOPY
2.0m



MEASURING CUP / MIARKA DO WODY



CERAMIC SOLEPLATE / CERAMICZNA STOPA

Functions / funkcje:

- ✓ Dry / Prasowanie na sucho
- ✓ Spray / Spryskiwacz
- ✓ Steam / Prasowanie z parą
- ✓ Burst of steam / Uderzenie pary
- ✓ Vertical steam / Pionowy wyrzut pary
- ✓ Self-cleaning / Funkcja samoczyszczenia
- ✓ Anti drip / Blokada kapania
- ✓ Anti calcium / System antywapnienny
- ✓ Auto shut off / Automatyczne wyłączenie
- ✓ Temperature control / Regulacja temperatury

LUND

No.	W	
68115	2800	10

PL Żelazko turystyczne
GB Travel iron
D Kompakt-Bügeleisen
RUS Туристический утюг

CZ Turistická žehlička
RO Fier de calcat pt calatorii
H Hordozható vasaló
E Plancha de viaje

220-240V-110-120V-50-60Hz
1100 W
80 ml
CERAMIC SOLEPLATE / CERAMICZNA STOPA
10±3 g/min
2.0m



FUNCTIONS / FUNKCJE:

- ✓ Dry / Prasowanie na sucho
- ✓ Steam / Prasowanie z parą
- ✓ Burst of steam / Uderzenie pary
- ✓ Temperature control / Regulacja temperatury



CERAMIC SOLEPLATE / CERAMICZNA STOPA



FOLDING HANDLE / SKŁADANA RĄCZKA



MEASURING CUP / MIARKA DO WODY

LUND

No.	W	
68100	1100	10

PL Parownica do ubrań
GB Garment steamer
D Dampfglätter
RUS Отпариватель для одежды

CZ Oděv parník
RO Aparat de calcat vertical
H Ruha gőztisztító
E Vapor de la ropa

220-240V-50-60Hz
600 W
100 ml
16 g/min
110°C max.
1.8m

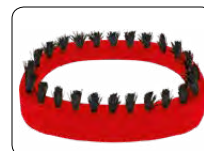

LUND

No.	W	
67231	600	12

PL Parownica do ubrań CZ Oděv parník
 GB Garment steamer RO Aparat de calcat vertical
 D Dampfglätter H Ruha gőztisztító
 RUS Отпариватель для одежды E Vapor de la ropa

220-240V-50Hz	1300 W
140 ml	22 g/min
110°C max.	1.8m

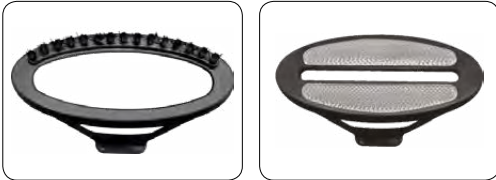

LUND

No.	W	
67230	1300	12

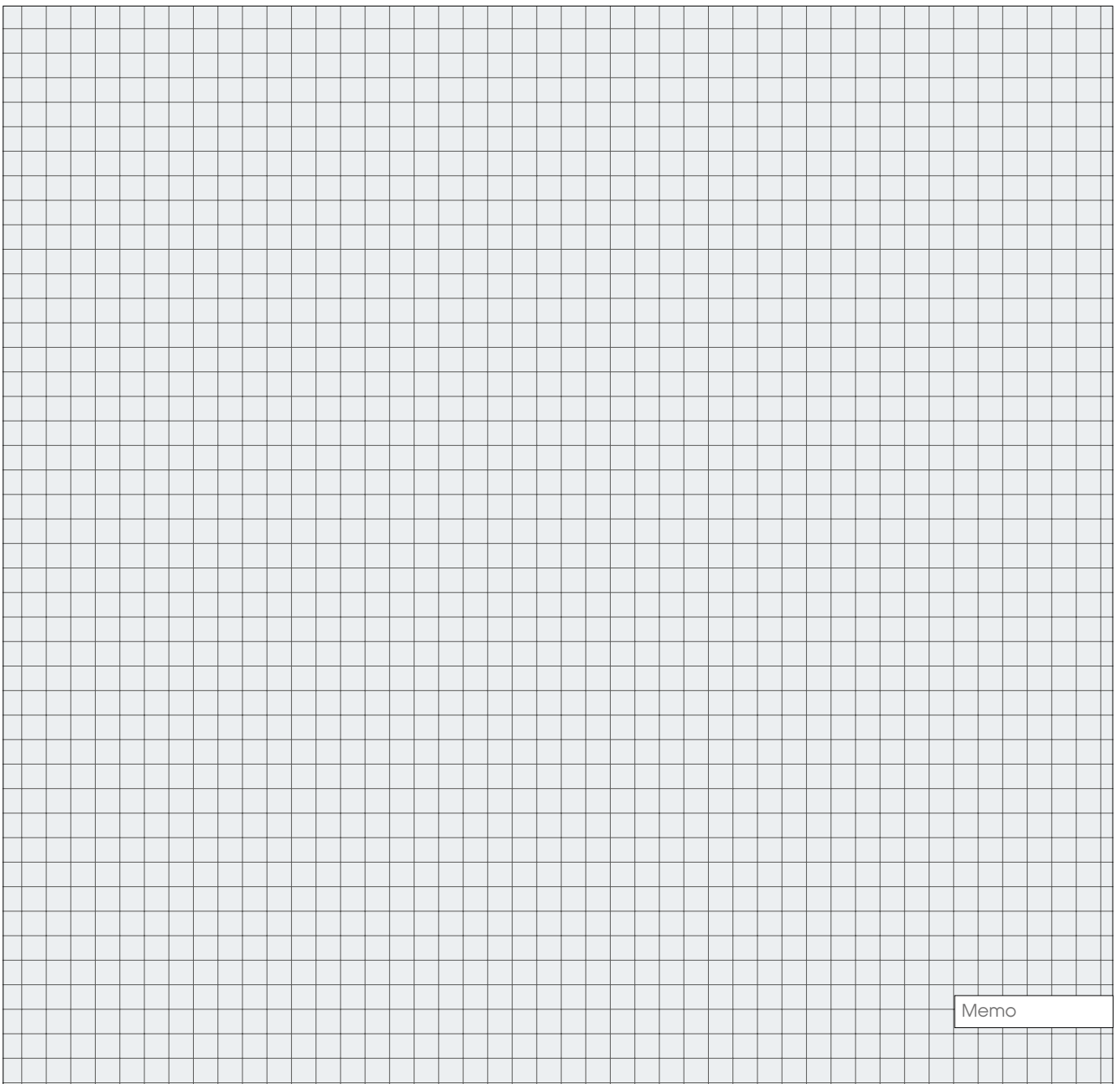















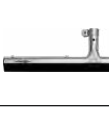

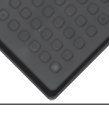

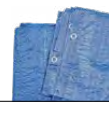
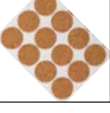

Memo

21

Household equipment
Gospodarstwo domowe



Mailboxes Skrzynki na listy	330-331	Hydraulic accessories Akcesoria hydrauliczne	344-345
Coal stoves & accessories Piecyki węglowe i akcesoria	331-335	Vaselines Wazeliny techniczne	345
Brushes Szcotki	335-337	Hand trucks Wózki magazynowe	345-346
Mops Zgarniacze do wody	337-338	Floor conveyors Transport poziomy	346-347
Multipurpose trays Podstawki gospodarcze	338	Casters Kółka	347-348
Bags Worki	338-340	Seals Uszczelnienia	349
Tarpaulins & accessories Plandeki i akcesoria	340-342	Self-adhesive furniture pads Podkładki samoprzylepne pod meble	349-352
Vacuum cleaners, ash separators & accessories Odkurzacze, separatory popiołu i akcesoria	342-344	Plastic stools Stołki plastikowe	352
Syphon pumps Pompy syfonowe	344	Hooks & furniture protection Haczyki i zabezpieczenia	352-355
Pumps Pompki	344	Hooks Wieszaki	355-356
			Cable organizers Organizery do kabli	356

PL Skrzynka na listy
GB Mailbox
D Briefkasten
RUS Почтовый ящик
CZ Schránka na dopisy
RO Cutie poştală
H Levélláda
E Buzón



285x200x60
mm



No.	size / rozmiar (mm)	slot width / szerokość wrzutu (mm)	colour / kolor	
78540	285x200x60	143	●	12
78541	285x200x60	143	●	12
78542	285x200x60	143	●	12
78543	285x200x60	143	●	12

PL Skrzynka na listy
GB Mailbox
D Briefkasten
RUS Почтовый ящик
CZ Schránka na dopisy
RO Cutie poştală
H Levélláda
E Buzón



400x250x100
mm



No.	size / rozmiar (mm)	slot width / szerokość wrzutu (mm)	colour / kolor	
78570	400x250x100	230	●	6
78571	400x250x100	230	●	6
78572	400x250x100	230	●	6

PL Skrzynka na listy
GB Mailbox
D Briefkasten
RUS Почтовый ящик
CZ Schránka na dopisy
RO Cutie poştală
H Levélláda
E Buzón



380x320x105
mm



No.	size / rozmiar (mm)	slot width / szerokość wrzutu (mm)	colour / kolor	
78580	380x320x105	220	●	5
78581	380x320x105	220	●	5
78582	380x320x105	220	●	5

PL Skrzynka na listy
GB Mailbox
D Briefkasten
RUS Почтовый ящик
CZ Schránka na dopisy
RO Cutie poştală
H Levélláda
E Buzón



360x260x80
mm



No.	size / rozmiar (mm)	slot width / szerokość wrzutu (mm)	colour / kolor	
78555	360x260x80	220	●	6
78556	360x260x80	220	●	6
78557	360x260x80	220	●	6

PL Skrzynka na listy
GB Mailbox
D Briefkasten
RUS Почтовый ящик
CZ Schránka na dopisy
RO Cutie poştală
H Levélláda
E Buzón



310x360x100
mm



No.	size / rozmiar (mm)	slot width / szerokość wrzutu (mm)	colour / kolor	
78575	310x360x100	320	●	6
78576	310x360x100	320	●	6
78577	310x360x100	320	●	6

PL Skrzynka na listy
GB Mailbox
D Briefkasten
RUS Почтовый ящик
CZ Schránka na dopisy
RO Cutie poştală
H Levélláda
E Buzón



380x320x105
mm



No.	size / rozmiar (mm)	slot width / szerokość wrzutu (mm)	colour / kolor	
78585	380x320x105	220	●	5
78586	380x320x105	220	●	5
78587	380x320x105	220	●	5

PL Skrzynka na listy
GB Mailbox
D Briefkasten
RUS Почтовый ящик

CZ Schránka na dopisy
RO Cutie poştală
H Levélláda
E Buzon

480x280x80
mm

2x



VOREL

No.	size / rozmiar (mm)	slot width / szerokość wrzutu (mm)	colour / kolor	☐
78590	480x280x80	198	●	5
78591	480x280x80	198	●	5
78592	480x280x80	198	●	5

PL Piec grzewczy
GB Heating stove
D Heizofen
RUS Печное отопление

CZ Vytápění kamna
RO Sobă de încălzire
H Kályha
E Estufa de calefacción



VOREL

No.	type / typ	kW	weight / waga (kg)	☐
73005	PW5G Eco	5	47	8

PL Zestaw kominkowy stojący
GB Fireplace set
D Kaminofen Zubehör im Stehständer
RUS Каминный набор 4 предмета
CZ Sada krbových nástrojů
RO Set de unelte pt. fier
H Kandalló tisztító
E Conjunto accesorios chimenea

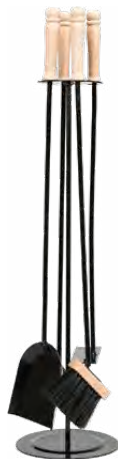

VOREL

No.	pcs	☐
72972	4	1

PL Piec grzewczy
GB Heating stove
D Heizofen
RUS Печное отопление

CZ Vytápění kamna
RO Sobă de încălzire
H Kályha
E Estufa de calefacción



VOREL

No.	type / typ	kW	weight / waga (kg)	☐
73004	PW5 Eco	5	49	8

PL Piec grzewczy
GB Heating stove
D Heizofen
RUS Печное отопление

CZ Vytápění kamna
RO Sobă de încălzire
H Kályha
E Estufa de calefacción



VOREL

No.	type / typ	kW	weight / waga (kg)	☐
73006	PP5 Eco	8	61	4

PL Zestaw kominkowy wiszący
GB Fireplace set
D Kaminofen Zubehör auf Wandhänger
RUS Каминный набор
„Настенный 4 предмета“
CZ Sada krbových nástrojů
RO Set de unelte pt. fier
H Kandalló tisztító
E Conjunto accesorios chimenea

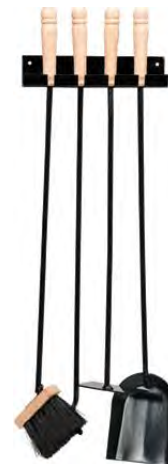

VOREL

No.	pcs	☐
72973	4	1

PL Blacha przyściopowa ocynkowana
 GB Galvanized stove metal plate
 D Brenblech, verzinkt
 RUS Оцинкованный лист для обшивки печи
 CZ Podložka pod pec z pozinkovaného plechu
 RO Tablă sobă zincată
 H Galvanizált hő terelő lemez kályhához
 E Chapa galvanizada para estufa



VOREL

No.	size / rozmiar (mm)	thickness / grubość (mm)	
72933	305x475	0.5	10
72934	396x600	0.5	10
72935	485x663	0.5	10

PL Przetyskacz
do wyczyszczenia kominowej
 GB Chimney brush
 D Kaminbürste
 RUS Щетка для дымохода

CZ Kominový kartáč
 RO Coș de perie
 H Kéménytisztító kefe
 E Brosse de cheminée

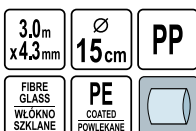

VOREL

No.	Ø (mm)	
72955	15	20

PL Wycior kominowy
 GB Chimney cleaner
 D Schornsteinreiniger
 RUS Щетка для трубочистов

CZ Kartáč kominový
 RO Racletă pt. coșul de fum
 H Kéménytisztító kefe
 E Arilla para baquetas de calefacción central



VOREL

No.	Ø (mm)	
72953	250	12
72954	300	8

PL Blacha przyściopowa malowana
 GB Painted stove metal plate
 D Brenblech, mit Farbanstrich
 RUS Оцинкованный окрашенный лист для обшивки печи
 CZ Podložka pod pec z lakovaného plechu
 RO Tablă sobă vopsită
 H Festett hő terelő lemez kályhához
 E Chapa pintada para estufa



VOREL

No.	size / rozmiar (mm)	thickness / grubość (mm)	
72936	476x603	0.5	10
72937	476x800	0.5	10

PL Wycior kominowy
 GB Chimney cleaner
 D Schornsteinreiniger
 RUS Щетка для трубочистов

CZ Kartáč kominový
 RO Racletă pt. coșul de fum
 H Kéménytisztító kefe
 E Arilla para baquetas de calefacción central



No.	Ø (mm)	
72948	120	15
72950	150	20
72951	175	18
72952	200	18

PL Wycior kominowy
 GB Chimney cleaner
 D Schornsteinreiniger
 RUS Щетка для трубочистов

CZ Kartáč kominový
 RO Racletă pt. coșul de fum
 H Kéménytisztító kefe
 E Arilla para baquetas de calefacción central



VOREL

No.	Ø (mm)	
72994	120	15
72995	150	20
72996	175	18
72997	200	18
72998	250	12

PL Lina kominarska
GB Chimney rope
D Schornsteinfeger-Seil
RUS Трос для чистки дымоходов

CZ Kominové lano
RO Franghie pt. cos de fum
H Kémény kótel
E Cuerda de chimenea



VOREL

No.	Ø (mm)	L (m)	
73021	6	10	15
73022	8	10	15

PL Kula kominarska żeliwna
GB Iron chimneysweep ball
D Schornsteinfegerkugel
RUS Гиря для трубочистов

CZ Kaminkrčičio kamuolys
RO Bilă pt. coșul de fum
H Kémény golyó
E Esfera del deholinador



No.		
72938	K15	4
72939	K25	4

PL Pręt do wyciorów
GB Central heating cleaning rod
D Stab für die Reiniger der Zentralheizung
RUS Черенок для щеток – центральное отопление
CZ Tyč k čistění
RO Tije pt. racleij încalzire centrală
H CO pálca a fűstcsőtisztító keféhez
E Baqueta para limpiar el sistema de calefacción central



No.	Ø (mm)	L (mm)	
72956	7	600	50
72958	7	800	50
72960	7	1000	50

PL Kula kominarska stalowa
GB Chimneysweep ball
D Zuggewicht aus Stahl
RUS Шар дымоходный для чистки дымоходов

CZ Kominová koule
RO Acél ontvény kéménygolyó
H Bila curatal cos de fum
E Bola de chimenea de acero



VOREL

No.	weight / waga (kg)	
73025	1.3	5
73026	1.8	5
73027	2.5	5

PL Zestaw kominarski
GB Chimney brush with iron ball
D Schornsteinfeger-Garnitur:
Zuggewicht Russbesen Seil
RUS Набор для чистки дымохода

CZ Kominový set
RO Perie cos cu bila + franghie
H Kéménytisztító szettek
E Redondo limpieza cepillo bola de acero



VOREL

No.	Ø (mm)		L (m)	
73031	125	K13	10	1
73032	150	K13	10	1
73033	175	K18	10	1
73034	200	K18	10	1
73035	250	K25	10	1

PL Drut kominowy
GB Chimney wire
D Schornsteindraht
RUS Проволока для трубочистов

CZ Kaminkrčičio trosas
RO Sărmă pt. coșul de fum
H Kéménytisztító drót
E Alambre de chimeneas



No.	Ø (mm)	L (m)	
72942	3.5	6	25
72943	3.5	8	20
72944	3.5	10	20
72945	3.5	12	20

PL Wycior do C.O.
GB Chimney cleaner
D Schornsteinreiniger
RUS Щетка для трубочистов

CZ Kartáč kominový
RO Racletă pt. coșul de fum
H Kéménytisztító kefe
E Arilla para baquetas de calefacción central



No.	Ø (mm)	
72963	30	50
72964	40	50
72965	50	50
72966	60	35
72967	70	35
72968	80	30
72969	90	20
72970	100	20

PL Szufelka gospodarcza
GB Shovel
D Schaufel
RUS Совок

CZ Lopatka
RO Lopățică
H Lapát
E Pala



VOREL

No.	mm	
72976	380x220	20

PL Szufelka szeroka
GB Shovel
D Schaufel
RUS Совок

CZ Lopatka
RO Lopățică
H Lapát
E Pala



No.	mm	
72975	460x220	40

PL Szufelka mala
GB Shovel
D Schaufel
RUS Совок

CZ Lopatka
RO Lopățică
H Lapát
E Pala



No.	mm	
72979	500x110	5/30

PL Szufelka angielska
GB Shovel
D Schaufel
RUS Совок

CZ Lopatka
RO Lopățică
H Lapát
E Pala



No.	mm	
72974	340x200	18

PL Pogrzebacz
GB Poker
D Schürreisen
RUS Кочера

CZ Pohrabáč
RO Vătrași
H Piszkavas
E Hurgón



No.	L (mm)	
72981	620	50

PL Szufelka
GB Shovel
D Schaufel
RUS Совок

CZ Lopatka
RO Lopățică
H Lapát
E Pala



No.	mm	
72977	550x180	30
72978	490x140	40

PL Węglarka duża
GB Coal carrier
D Kohlenkasten
RUS Ведро для угля

CZ Uhlák
RO Rezervor de cărbuni pt. sobă
H Szeneskosár
E Carbonera



No.	L (mm)	W (mm)	H (mm)	
72984	385	210	125	5

- PL Węgłarka mala CZ Uhlák
 GB Coal carrier RO Rezervor de cărbuni pt. sobă
 D Kohlenkasten H Szeneskosár
 RUS Ведро для угля E Carbonera



No.	L (mm)	W (mm)	H (mm)	
72985	370	200	175	5

- PL Dwustronny mop ze spryskiwaczem
 GB Double-sided microfiber spray mop
 D Spritz Mop
 RUS Спрей швабра
 CZ Střikací mop
 RO Mop cu pulverizare
 H Permetező mop
 E Rocíar fregona

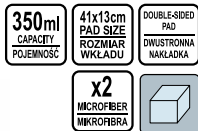

LUND



- FEATURES / CECHY:**
 ✓ Wet & dry cleaning / Mycie na mokro i na sucho
 ✓ For every type of surface: wood, floor panel, tile, stone, PVC / Do każdego rodzaju powierzchni: drewno, panel podłogowy, płytki, kamień, PCV
 ✓ Multidirectional mop head / Wielokierunkowa stopa czyszcząca

No.	
67161	12

- PL Mikrofibra CZ Mikrovlákno
 GB Microfiber RO Microfibră
 D Mikrofaser H Mikroszálás
 RUS Микроволокно E Microfibra



LUND

No.	size / rozmiar (cm)	for / dla	
67164	41x13	67161	100

- PL Mop ze spryskiwaczem z myjką do okien
 GB Microfiber spray mop and window wiper
 D Spritz Mop
 RUS Спрей швабра
 CZ Střikací mop
 RO Mop cu pulverizare
 H Permetező mop
 E Rocíar fregona



LUND



- FEATURES / CECHY:**
 ✓ For every type of surface: wood, floor panel, tile, stone, PVC / Do każdego rodzaju powierzchni: drewno, panel podłogowy, płytki, kamień, PCV
 ✓ Multidirectional mop head / Wielokierunkowa stopa czyszcząca

No.	
67160	12

- PL Mop ze spryskiwaczem z myjką do okien
 GB Microfiber spray mop and window wiper
 D Spritz Mop
 RUS Спрей швабра
 CZ Střikací mop
 RO Mop cu pulverizare
 H Permetező mop
 E Rocíar fregona



LUND



- FEATURES / CECHY:**
 ✓ For every type of surface: wood, floor panel, tile, stone, PVC / Do każdego rodzaju powierzchni: drewno, panel podłogowy, płytki, kamień, PCV
 ✓ Multidirectional mop head / Wielokierunkowa stopa czyszcząca

No.	
67162	12

- PL Mikrofibra CZ Mikrovlákno
 GB Microfiber RO Microfibră
 D Mikrofaser H Mikroszálás
 RUS Микроволокно E Microfibra



LUND

No.	size / rozmiar (cm)	for / dla	
67165	41x13	67160; 67161	150

PL Mikrofibra CZ Mikrowłókno
 GB Microfiber RO Microfibră
 D Mikrofaser H Mikroszálas
 RUS Микроволоно E Microfibra



LUND

No.	size / rozmiar (cm)	for / dla	
67166	26x7	67162	500

PL Miotła CZ Metla
 GB Broom RO Matura
 D Strassenbesen H Partvis
 RUS Метла E Cepillo pelo largo



No.	mm	
35867	300x65	10
35868	400x65	10

PL Miotła CZ Metla
 GB Broom RO Matura
 D Strassenbesen H Partvis
 RUS Метла E Cepillo pelo largo



No.	L (mm)	
35870	300	10
35872	400	10
35874	500	10
35875	600	10
35876	800	10
35877	1000	10

PL Miotła drucziana do bruku CZ Metla
 GB Broom RO Matura
 D Strassenbesen H Partvis
 RUS Метла E Cepillo pelo largo



VOREL

No.	L (mm)	
35923	300x55	6
35924	400x55	6

PL Szczotka obrotowa
 GB Floor sweeper
 D Boden sweeper
 RUS Турбо-щётка
 CZ Mechanický zametač
 RO Pozea peria
 H Forgó kefések
 E Barredora de escoba



FEATURES / CECHY:

- ✓ Great for pet hair / Odpowiedni do sierści zwierząt
- ✓ Capacious basket / Pojemny kosz
- ✓ For every type of surface: wood, floor panel, tile, stone, PVC / Do każdego rodzaju powierzchni: drewno, panel podłogowy, płytki, kamień, PCV



LUND

No.	
67163	18

PL Miotła CZ Metla
 GB Broom RO Matura
 D Strassenbesen H Partvis
 RUS Метла E Cepillo pelo largo



No.	
35869	10

PL Miotła CZ Metla
 GB Broom RO Matura
 D Strassenbesen H Partvis
 RUS Метла E Cepillo pelo largo



No.	L (mm)	
35914	400x55	10
35915	500x55	10
35916	600x55	10
35918	800x55	10

PL Miotła CZ Metla
 GB Broom RO Matura
 D Strassenbesen H Partvis
 RUS Метла E Cepillo pelo largo



No.	L (mm)	
35911	1150x250	140

PL Miotła
GB Broom
D Strassenbesen
RUS Метла

CZ Metla
RO Matura
H Partvis
E Cepillo pelo largo

NYLON



FLO

No.	L (mm)	
35912	1200x360	15

PL Miotła
GB Broom
D Strassenbesen
RUS Метла

CZ Metla
RO Matura
H Partvis
E Cepillo pelo largo



No.	L (mm)	
35899	250	12

PL Miotła
GB Broom
D Strassenbesen
RUS Метла

CZ Metla
RO Matura
H Partvis
E Cepillo pelo largo



FLO

No.	bristle length / długość włosia (mm)	
35906	135	12

PL Szczotka do kosiarki
GB Lawn mower brush
D Rasenmäher Reinigungsbürste mit Schaber
RUS Щетка для очистки газонокосилки

CZ Kartáč na čištění sekačky
RO Perie pt. curatat motocoase
H Ecset a kaszák tisztításához
E Cepillo limpieza



FLO

No.	mm	
35950	310x50	15

PL Miotła
GB Broom
D Strassenbesen
RUS Метла

CZ Metla
RO Matura
H Partvis
E Cepillo pelo largo



No.	L (mm)	
35893	300	12
35894	400	12
35895	500	12

PL Miotła
GB Broom
D Strassenbesen
RUS Метла

CZ Metla
RO Matura
H Partvis
E Cepillo pelo largo



FLO

No.	bristle length / długość włosia (mm)	
35905	275	12

PL Miotła
GB Broom
D Strassenbesen
RUS Метла

CZ Metla
RO Matura
H Partvis
E Cepillo pelo largo



FLO

No.	bristle length / długość włosia (mm)	
35908	210	8

PL Myjka do okien ze spryskiwaczem
GB Spray window cleaner
D Spritzfenster-Reiniger
RUS Очиститель окон
CZ Čistič oken
RO Stergator geam cu spray
H Ablakmosó
E Limpiador de ventanas



LUND

No.	
67170	12

PL Mikrofibra
GB Microfiber
D Mikrofaser
RUS Микроволокно

CZ Mikrovláknó
RO Microfibră
H Mikroszálás
E Microfibra



LUND

No.	size / rozmiar (cm)	for / dla	
67171	25x7	67170	500

PL Wielofunkcyjna podstawa gospodarcza
GB All purpose boot tray
D Garten- & Haushalt-Unterlage
RUS Многофункциональный поднос
CZ Multifunkční podložka
RO Tava multifunctionala
H Többfunkciós tálcá
E Bandeja de arranque universal

780 x 384
x 32 mm

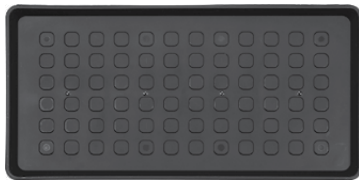

VOREL

No.	mm	
67260	780x384x32	30

PL Worki na styropian
GB Waste bags for styrofoam
D Styropor Entsorgungssäcke
RUS Пакеты для мусора строительных материалы

CZ Pytle na polystyren
RO Saci gunoi
H Szemeteszsák
E Sacos de poliestireno

LDPE



VOREL

No.	l	pcs	µm	
09472	240	10	40	10

PL Worki na odpady, budowlane
GB Construction waste bags
D Müllsäcke
RUS Мешки для строительного мусора

CZ Pytle na stavební odpad
RO Saci gunoi pt. santier
H Zsák építési törmelékhez
E Bolsas para desperdicios de construcción

LDPE



VOREL

No.	l	pcs	µm	
09470	80	10	40	30
09471	120	15	60	10

PL Zgarniacz do wody
GB Mop
D Wasserschieber
RUS Сгон для уборки воды

CZ Stěrka s gumou
RO Mop cauciuc
H Vízlehúzó gumi
E Recogedor de agua universal



VOREL

No.	L (mm)	
04561	330	120
04562	430	12/96

PL Worki na gruz, mocne
GB Debris bags
D Müllsäcke stabil
RUS Мешки для щебня

CZ Pytle na sut'
RO Saci pt. demolari
H Sítkes zsák
E Bolsas para escombros

LDPE



VOREL

No.	l	pcs	µm	
09475	80	10	142	10
09476	80	3	142	10
09477	120	10	142	10
09478	120	3	142	10

PL Worki na odpady, mocne
GB Waste bags
D Müllbeutel
RUS Пакеты для мусора

CZ Pytle na odpad
RO Saci gunoi
H Szemeteszsák
E Bolsas para desperdicios

LDPE



VOREL

No.	l	pcs	µm	
09465	120	10	30	25
09466	160	10	40	15
09467	240	10	40	10

PL Worki ogrodowe
GB Garden bags
D Gartensäcke
RUS Мешки для огорода

CZ Zahradní pytle
RO Saci gunoi pt. gradina
H Kerti szemeteszsák
E Bolsas de jardín

LDPE



FLO

No.	l	pcs	µm	
09481	120	10	60	15

PL Worki ogrodowe z taśmą
GB Garden bags with cord
D Gartensäcke mit Band
RUS Мешки для огорода с лентой

CZ Zahradní pytle zatahovací
RO Saci gunoi pt. gradina cu strangere
H Szalagos kerti szemétszák
E Bolsas de jardín con cinta

TASMA
SCIEGALAJACA
SHRINKING
BAND

LDPE



FLO

No.	l	pcs	µm	
09480	60	10	60	12
09482	120	10	60	15

PL Worki perforowane na liście
GB Perforated waste bags for leafs
D Gartenmüllsäcke perforiert
RUS Мусорные пакеты прочные для листьев

CZ Perforované odpadové pytle na list
RO Saci gunoi pt. frunze
H Szemeszszak
E Sacos perforadas para residuos de jardín

PERFORATED
PERFOROWANY

LDPE



FLO

No.	l	pcs	µm	
09484	200	10	40	12

PL Worki na odpady super mocne
GB Waste bags super strong
D Müllsäcke extra stark
RUS Пакеты для мусора прочные

CZ Super- silný pytle na odpad
RO Sag gunoi super rezistent
H Szemeszszak
E Sacos de residuos super fuertes

SUPER
STRONG
BARDO
MOCNE

LDPE



VOREL

No.	l	pcs	µm	
09473	35	50	30	10

PL Worki na odpady z uszami, mocne
GB Waste bags strong with holder
D Müllsäcke mit Griff stark
RUS Пакеты для мусора с завязками прочные
CZ Odpadkové pytle s rukojeti
RO Saci gunoi rezistent cu maner
H Szemeszszak
E Sacos de desecho fuertes con soporte

EASY
TYING
LATIVE
WIAZANIE

STRONG
MOCNE

MDPE



VOREL

No.	l	pcs	µm	
09474	60	20	20	25

PL Worki perforowane na trawę
GB Waste bags for grass
D Gartenmüllsäcke perforiert
RUS Мусорные пакеты прочные для листьев

CZ Perforované odpadové pytle na tráve
RO Saci gunoi pt. iarba
H Szalagos kerti szemétszák
E Sacos perforadas para residuos de jardín

PERFORATED
PERFOROWANY

LDPE



FLO

No.	l	pcs	µm	
09483	120	10	35	25

PL Worki na odpady domowe
GB Waste bags
D Müllbeutel
RUS Пакеты для мусора

CZ Pytle na odpad
RO Saci gunoi
H Szemeszszak
E Bolsas para desperdicios

PERFORATED
PERFOROWANY

LDPE



VOREL

No.	l	pcs	µm	material / material	
09486	35	50	6	HDPE	40
09487	35	30	11	MDPE	45
09489	60	20	13	MDPE	45

PL Worki na odpady domowe z taśmą
GB Waste bags with cord
D Müllbeutel mit Band
RUS Пакеты для мусора с лентой

CZ Pytle na odpad
RO Saci gunoi
H Szemeszszak
E Bolsas para desperdicios

TASMA
SCIEGALAJACA
SHRINKING
BAND

LDPE



VOREL

No.	l	pcs	µm	
09490	60	10	30	25

PL Worki na odpady z nadrukami
GB Waste bags
D Müllbeutel
RUS Пакеты для мусора

CZ Pytle na odpad
RO Saci gunoi
H Szemeszszak
E Bolsas para desperdicios

PLASTIC
PLASTIK

LDPE



VOREL

No.	l	pcs	µm	
10010	120	10	40	25

PL Worki na odpady z nadrukiem CZ Pytle na odpad
 GB Waste bags RO Saci gunoi
 D Müllbeutel H Szemeteszsák
 RUS Пакеты для мусора E Bolsas para desperdicios



No.	l	pcs	µm	
10011	120	10	40	25

PL Worki na odpady z nadrukiem CZ Pytle na odpad
 GB Waste bags RO Saci gunoi
 D Müllbeutel H Szemeteszsák
 RUS Пакеты для мусора E Bolsas para desperdicios



No.	l	pcs	µm	
10013	120	10	40	25

PL Worki na odpady z nadrukiem CZ Pytle na odpad
 GB Waste bags RO Saci gunoi
 D Müllbeutel H Szemeteszsák
 RUS Пакеты для мусора E Bolsas para desperdicios



No.	l	pcs	µm	
10015	120	10	40	25

PL Plandeka CZ Plachta
 GB Tarpaulin RO Husă
 D Plane H Ponyva
 RUS Тент E Toldo



PL Worki na odpady z nadrukiem CZ Pytle na odpad
 GB Waste bags RO Saci gunoi
 D Müllbeutel H Szemeteszsák
 RUS Пакеты для мусора E Bolsas para desperdicios



No.	l	pcs	µm	
10012	120	10	40	25

PL Worki na odpady z nadrukiem CZ Pytle na odpad
 GB Waste bags RO Saci gunoi
 D Müllbeutel H Szemeteszsák
 RUS Пакеты для мусора E Bolsas para desperdicios



No.	l	pcs	µm	
10014	120	10	40	25

PL Plandeka
 GB Tarpaulin
 D Plane
 RUS Тент
 CZ Plachta
 RO Husă
 H Ponyva
 E Toldo

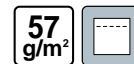

No.	m	g/m2	
85122	2x3	57	30
85123	3x5	57	20
85124	4x5	57	10
85125	4x6	57	8
85126	5x8	57	5
85128	6x10	57	3
85129	8x12	57	2
85130	10x15	57	2



No.	m	g/m2	
85112	2x3	75	30
85113	3x5	75	10
85114	4x5	75	10
85115	4x6	75	8
85116	5x8	75	5
85118	6x10	75	3
85119	8x12	75	2
85120	10x15	75	2

PL Plandeka CZ Plachta
 GB Tarpaulin RO Husă
 D Plane H Ponyva
 RUS Тент E Toldo

90
g/m²



No.	m	g/m ²	☐
85020	2x3	90	30
85030	3x5	90	18
85040	4x5	90	9
85050	4x6	90	10
85060	5x8	90	5
85080	6x10	90	4
85090	8x12	90	2
85100	10x15	90	1



PL Uchwyty zaciskowe ze śrubą do mocowania plandek
 GB Tarpaulin clips
 D Kunststoff Planenhalter
 RUS Пластиковый клипс зажим для палаток и тентов
 CZ Držáky k zakrývacím plachtám
 RO Clame pt. prelate
 H Ponyvárógzító klipsz
 E Pinzas para lonas

8
PCS
NYLON
FOR TARPAILINS
DO PLANDEK



No.	pcs	☐
85170	8	12/48

PL Uchwyty zaciskowe do mocowania plandek
 GB Tarpaulin clips
 D Kunststoff Planenhalter
 RUS Пластиковый клипс зажим для палаток и тентов
 CZ Držáky k zakrývacím plachtám
 RO Clame pt. prelate
 H Ponyvárógzító klipsz
 E Pinzas para lonas

8
PCS
PE
FOR TARPAILINS
DO PLANDEK



No.	pcs	☐
85174	8	12/48

PL Guma mocująca z kulką
 GB Ball bungee cords
 D Planenspanner Spanngummi mit Kunststoffkugel
 RUS Резиновая петля с шариком
 CZ Upinací gumy s plastovo kuličkou
 RO Cordelina elastica cu bila fixare
 H Ponyva rőgzítő gumipók
 E Tensor de goma con bola de plástico

8
PCS
25
Ømm
200
mm
FOR TENTS,
TARPAILINS
DO NAMOTÓV,
PLANDEK



No.	pcs	☐
85180	8	24/96

PL Uchwyty zaciskowe do mocowania plandek
 GB Tarpaulin clips
 D Kunststoff Planenhalter
 RUS Пластиковый клипс зажим для палаток и тентов
 CZ Držáky k zakrývacím plachtám
 RO Clame pt. prelate
 H Ponyvárógzító klipsz
 E Pinzas para lonas

8
PCS
PP
FOR TARPAILINS
DO PLANDEK



No.	pcs	☐
85172	8	72

PL Linka pleciona, elastyczna
 GB Elastic rope
 D Polypropylen-Gummileine
 RUS Шнур эластичный
 CZ Lano opletené elastické
 RO Funie elastica
 H Rugalmas kötél
 E Cuerda trenzada

8
Ømm
RUBBER
CORE
GUMOWY
ROZEN
PP
BRAID
OPLOOT
FOR TARPAILINS
DO PLANDEK



No.	Ø (mm)	L (m)	☐
85177	8	15	20
85178	8	30	8

PL Szpilki stalowe do mocowania plandek
 GB Metal pegs for fixing tarpaulins
 D Metallhaken zum Befestigen von Planen
 RUS Металлические кольчки для шнуров растяжки тентов и палаток
 CZ Kolíky pro plachtoviny
 RO Carligi metalici pt. prelate
 H Napellenző csapok
 E Piqueta para lonas

10
PCS
180
mm
FOR TENTS,
TARPAILINS
DO NAMOTÓV,
PLANDEK

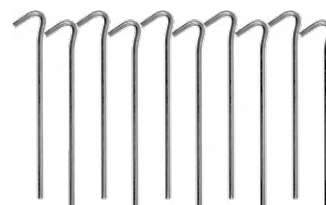

No.	pcs	☐
85185	10	18/36

PL Taśma klejąca do naprawy plandek
GB Tarpaulin repair tape
D Planen-Reparatur-Klebeband
RUS Самоклеящаяся лента тарпаулиновая, для ремонта тентов

CZ Páska maskovací textilní pro plachtoviny
RO Bandă adezivă de reparații pt. prelate
H Szövetszalag ezüst
E Cinta adhesiva de reparación para lonas

50mm
8m

DUCT

FOR
TARPAULINS
DO PLANDEK



No.	W (mm)	L (m)	Icon
85190	50	8	72

PL Separator do popiołu
GB Ash separator
D Ascheabscheider
RUS Пепла сепаратор

CZ Odlučovač popela
RO Filtru pt. cenușă
H Hamuporszívó
E Separador de ceniza

18l
3-4 cm

FIREPROOF
HOSE
ZARÓDOPORNY
WĄZ

FOR GRILL
& FIREPLACE
DO GRILLA
I KOMINKA

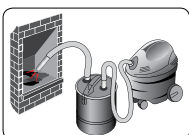

FOR USE WITH VACUUM CLEANER
/ DO ZASTOSOWANIA Z ODKURZACZEM



ALUMINIUM SUCTION NOZZLE
/ ALUMINIOWA KONCÓWKA

No.	W	Icon
72920	1	1

PL Odkurzacz do popiołu
GB Ash cleaner
D Aschesauger
RUS Пылесос для золы

CZ Vysavač popela
RO Aspirator pt. cenușă
H Hamuporszívó
E Aspirador de cenizas

230V~
50Hz
800
W
20l

16
kPa

BLOW
FUNCTION
FUNKCJA
DMUCHAWY

FOR GRILL
& FIREPLACE
DO GRILLA
I KOMINKA

FIREPROOF
HOSE
ZARÓDOPORNY
WĄZ

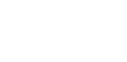

BLOW FUNCTION
/ FUNKCJA DMUCHAWY



STAINLESS STEEL TANK
/ POJEMNIK ZE STALI
NIERDZEWNEJ



ALUMINIUM SUCTION NOZZLE
/ ALUMINIOWA KONCÓWKA



No.	W	Icon
78870	800	1

PL Taśma klejąca do naprawy plandek
GB Tarpaulin repair tape
D Planen-Reparatur-Klebeband
RUS Самоклеящаяся лента тарпаулиновая, для ремонта тентов

CZ Páska maskovací textilní pro plachtoviny
RO Bandă adezivă de reparații pt. prelate
H Szövetszalag ezüst
E Cinta adhesiva de reparación para lonas

50mm
8m

DUCT

FOR
TARPAULINS
DO PLANDEK



No.	W (mm)	L (m)	Icon
85191	50	8	72

PL Odkurzacz do popiołu
GB Ash cleaner
D Aschesauger
RUS Пылесос для золы

CZ Vysavač popela
RO Aspirator pt. cenușă
H Hamuporszívó
E Aspirador de cenizas

230V~
50Hz
800
W
18l

14
kPa

BLOW
FUNCTION
FUNKCJA
DMUCHAWY

FOR GRILL
& FIREPLACE
DO GRILLA
I KOMINKA



BLOW FUNCTION
/ FUNKCJA DMUCHAWY



ALUMINIUM SUCTION NOZZLE
/ ALUMINIOWA KONCÓWKA

No.	W	Icon
72928	800	1

PL Odkurzacz przemysłowy
GB Industrial vacuum cleaner
D Industriesauger
RUS Пылесос промышленный
CZ Průmyslový vysavač
RO Aspirator industrial
H Ipari poriszívó
E Aspirador industrial

220-240V~
50/60Hz
1000
W

15l
18
kPa

IPX4



No.	W	Icon
78872	1000	1

PL Odkurzacz przemysłowy
 GB Industrial vacuum cleaner
 D Industriesauger
 RUS Пылесос промышленный
 CZ Průmyslový vysavač
 RO Aspirator industrial
 H Ipari porszívó
 E Aspirador industrial



220-240V-50/60Hz	1200 W
20l	18 kPa
IPX4	



No.	W	V	
78874	1200		1

PL Odkurzacz samochodowy
 GB Car vacuum cleaner
 D Handsauger
 RUS Ручной пылесос для автомобиля

CZ Vysavač do auta
 RO Aspirator de masina
 H Autó porszívó
 E Aspirador para coche

100 W	12 V
	BAGLESS BEZWORKOWY



No.	W	V	
82952	100	12	20

PL Odkurzacz samochodowy
 GB Car vacuum cleaner
 D Handsauger
 RUS Ручной пылесос для автомобиля

CZ Vysavač do auta
 RO Aspirator de masina
 H Autó porszívó
 E Aspirador para coche

80 W	7.4V 2000mAh Li-Ion	4 h CHARGING TIME CZAS ŁADOWANIA
20 min WORK TIME CZAS PRACY		BAGLESS BEZWORKOWY



No.	W	V	
82954	80		20

PL Odkurzacz samochodowy
 GB Car vacuum cleaner
 D Handsauger
 RUS Ручной пылесос для автомобиля

CZ Vysavač do auta
 RO Aspirator de masina
 H Autó porszívó
 E Aspirador para coche

100 W	12 V	
WET AND DRY SUCHO MOKRO	BAGLESS BEZWORKOWY	



No.	W	V	
82951	100	12	8

PL Odkurzacz samochodowy
 GB Car vacuum cleaner
 D Handsauger
 RUS Ручной пылесос для автомобиля

CZ Vysavač do auta
 RO Aspirator de masina
 H Autó porszívó
 E Aspirador para coche

80W VACUUM CLEANER ODKURZACZ	120W COMPRESSOR KOMPRESOR	12 V	20 l/min
1.0 MPa		BAGLESS BEZWORKOWY	



No.	W	V	
82953	80/120	12	12

PL Filtr
 GB Filter
 D Filter
 RUS Фильтр

CZ Filtr
 RO Filtru
 H Szűrő
 E Filtro

FOR/DLA 72930	
---------------	--



No.	for / dla	
72931	72930; 78870	35

PL Waż metalowy
GB Metal hose
D Metallschlauch
RUS Металлический шланг

CZ Kovová hadice
RO Furtun metalic
H Hajlékony, fém tömlő
E Manguera de metal



No.	for / dla	☐
72922	72920	20

PL Pompa syfonowa
GB Syphon pump
D Siphon-Pumpe
RUS Сифонный насос

CZ Pumpa syfónová
RO Pompa manuala pt. combustibil
H Szifon pumpa
E Bomba de sífon



No.	☐
78020	30/60

PL Pompa wielofunkcyjna
GB Multi-purpose pump
D Multifunktionale Pumpe
RUS Многофункциональный насос

CZ Univerzální pumpička
RO Pompă multifuncțională
H Többfunkciós szivattyú
E Bomba multiusos



No.	☐
78022	6/24

PL Pompa do udrażniania kanalizacji
GB Drain suction pump
D Hochdruck-Rohrreiner
RUS Ручной насос для прочистки труб

CZ Čerpadlo na čištění trubek
RO Pompă pt. curățarea țevilor
H Csőtisztító szivattyú
E El desagüe del fregadero limpiador



No.	Ø (mm)	☐
55505	65; 155	24



PL Waż metalowy
GB Metal hose
D Metallschlauch
RUS Металлический шланг

CZ Kovová hadice
RO Furtun metalic
H Hajlékony, fém tömlő
E Manguera de metal

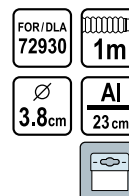

No.	for / dla	☐
72932	72930	18

PL Pompa syfonowa
GB Syphon pump
D Siphon-Pumpe
RUS Сифонный насос

CZ Pumpa syfónová
RO Pompa manuala pt. combustibil
H Szifon pumpa
E Bomba de sífon



No.	☐
78021	24

PL Pistolet do udrażniania rur
GB Drain cleaner
D Pistole zum Reinigen von Röhren
RUS Пистолет для прочистки труб
CZ Pistole na čištění trubek
RO Pistol pt. curățarea țevilor
H Csőtisztító pisztoly
E Pistola destapacaños



No.	Ø (mm)	☐
55500	135	10

PL Przepychacz do udrażniania kanalizacji
GB Pipe cleaner
D Raumdorn zum Reinigen der Kanalisation
RUS Поршень для прочистки канализации

CZ Tlakový čistěč kanalizace
RO Piston pt. deblocarea canalizării
H Lefolyótisztító pumpa
E Bomba desatascadors



No.	L (cm)	pcs	Box
55531	65	2	36

PL Spirala kanalizacyjna
GB Drain auger
D Hand-Rohrreinigungsspirale
RUS Трос сантехнический пружинный

CZ Spirála kanalizační
RO Dispozitiv de desfundat scurgere
H Csőtisztító spirál
E Desatascador espiral



No.	Ø (mm)	L (m)	Box
55544	9	5	5/10
55545	9	10	4/8

PL Wózek transportowy poziomy
GB Cargo pilot
D Transportwagen Klappbar
RUS Тележка с платформой
CZ Vozík skladový
RO Carut pt. gabarit
H Rakodó kocsi
E Carretilla de carga

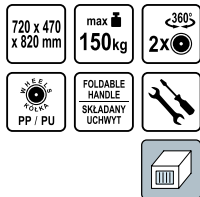

No.	max. capacity / max. ładowność (kg)	Box
87600	150	1

PL Spirala kanalizacyjna
GB Drain auger
D Hand-Rohrreinigungsspirale
RUS Трос сантехнический пружинный

CZ Spirála kanalizační
RO Dispozitiv de desfundat scurgere
H Csőtisztító spirál
E Desatascador espiral



No.	Ø (mm)	L (m)	Box
55541	5	1.5	20/80
55542	6	3	18/36

PL Wazelina techniczna
GB Vaseline
D Vaseline
RUS Вазелин технический

CZ Technická vazelina
RO Vaselină tehnică
H Műszaki vazelin
E Vaselina tecnica



No.	ml	Box
86700	50	50
86701	100	50

PL Składany wózek magazynowy
GB Foldable hand truck
D Klappbare Transportkarre
RUS Складная тележка
CZ Skladací hliníkový rudi
RO Carucior cu manere pliabil
H Öszszecsukható kézikocsi
E Carretilla de mano plegable

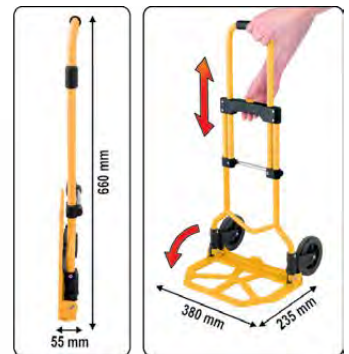

No.	max. capacity / max. ładowność (kg)	Box
78660	70	1

- PL Składany wózek magazynowy
- GB Foldable hand truck
- D Klappbare Transportkarre
- RUS Складная тележка
- CZ Skladací hliníkový rudi
- RO Carucior cu manere pliable
- H Öszecsukható kézikocsi
- E Carretilla de mano plegable



No.	max. capacity / max. ładowność (kg)	1
78661	90	1

- PL Pas do przenoszenia ładunku
- GB Lifting and moving strap
- D Gürtel zum Bewegen von Heben
- RUS Такелажный ремень для переноски грузов
- CZ Pás pro ruční přenášení nákladu
- RO Curea pt. mutal obiecte
- H Emelő mozgó pánt
- E Cinturón para llevar carga

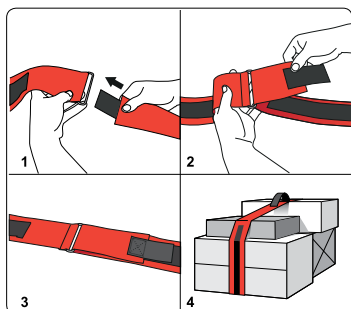

No.	32/128	1
74723	32/128	1

- PL Pasy do przenoszenia mebli
- GB Lifting and moving straps
- D Gürtel zum Bewegen von Heben
- RUS Ремни для переноски мебели
- CZ Pohyblivé pásy pro zvedání nábytku
- RO Curele pt. mutal obiecte
- H Emelő mozgó pántok
- E Cinturonos para llevar muebles

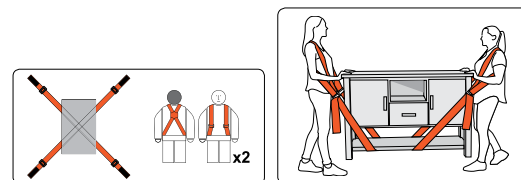
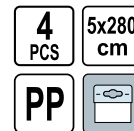

No.	pcs	10/20
74721	4	10/20

- PL Pasy do przenoszenia mebli
- GB Lifting and moving straps
- D Gürtel zum Bewegen von Heben
- RUS Ремни для переноски мебели
- CZ Pohyblivé pásy pro zvedání nábytku
- RO Curele pt. mutal obiecte
- H Emelő mozgó pántok
- E Cinturonos para llevar muebles



No.	pcs	15/30
74722	4	15/30

- PL Pasy do przenoszenia mebli
- GB Lifting and moving straps
- D Gürtel zum Bewegen von Heben
- RUS Ремни для переноски мебели
- CZ Pohyblivé pásy pro zvedání nábytku
- RO Curele pt. mutal obiecte
- H Emelő mozgó pántok
- E Cinturonos para llevar muebles

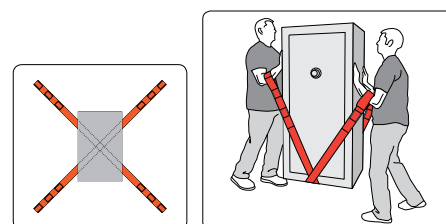
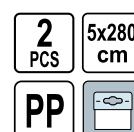

No.	pcs	33/66
74724	2	33/66

PL Zestaw rolek do transportu mebli CZ Sada na stěhování nábytku
 GB Furniture transport roller set RO Set transport si ridicat mobila
 D Möbel transportroller set H Bütorszállító készlet
 RUS Набор для перемещения мебели E Muebles transporte conjunto



No.	pcs	box
87245	5	12

PL Kółko stałe
 GB Fixed caster
 D Bockrolle
 RUS Ролик с стационарной опорой
 CZ Pevné kolečko
 RO Roata de carucior fixa
 H Szállítógörgök
 E Rueda fija

TEMPERATURE TOLERANCE
 ODPORNOSC NA TEMPERATURE
 -10°C ÷ +50°C

RUBBER
 GUMA

ROLLER BEARING
 ŁO YSKO
 WALECZKOWE



No.	wheel diameter / średnica kółka (mm)	wheel width / szerokość kółka (mm)	caster height / wysokość kółka (mm)	load capacity / obciążalność (kg)	box
87301	75	23	97	40	60
87302	100	27	130	60	32
87303	125	34	155	100	22
87305	160	40	195	130	10
87307	200	46	235	150	8

PL Kółko skrętnie z czarną gumą
 GB Swivel caster
 D Lenkrolle mit Feststeller
 RUS Ролик с вращающейся опорой
 CZ Otočné kolečko
 RO Roata de carucior mobila
 H Szállítógörgök
 E Rueda giratoria con freno

TEMPERATURE TOLERANCE
 ODPORNOSC NA TEMPERATURE
 -10°C ÷ +50°C

RUBBER
 GUMA

DOUBLE BRAKE
 PODWÓJNY HAMULEC

ROLLER BEARING
 ŁO YSKO
 WALECZKOWE



No.	wheel diameter / średnica kółka (mm)	wheel width / szerokość kółka (mm)	caster height / wysokość kółka (mm)	load capacity / obciążalność (kg)	box
87321	75	23	97	40	40
87322	100	27	130	60	20
87323	125	34	155	100	16
87325	160	40	195	130	8
87327	200	46	235	150	6

PL Kółko skrętnie z szarą gumą
 GB Swivel caster
 D Lenkrolle mit Feststeller
 RUS Ролик с вращающейся опорой
 CZ Otočné kolečko
 RO Roata de carucior mobila
 H Szállítógörgök
 E Rueda giratoria con freno

TEMPERATURE TOLERANCE
 ODPORNOSC NA TEMPERATURE
 -10°C ÷ +50°C

RUBBER
 GUMA

PLAIN BEARING
 ŁO YSKO
 LISZCOWE



No.	wheel diameter / średnica kółka (mm)	wheel width / szerokość kółka (mm)	caster height / wysokość kółka (mm)	load capacity / obciążalność (kg)	box
87351	50	16	72	20	140
87352	75	21	104	30	60
87353	100	26	134	45	38
87354	125	27	161	50	25

PL Kółko skrętnie z czarną gumą
 GB Swivel caster
 D Lenkrolle mit Feststeller
 RUS Ролик с вращающейся опорой
 CZ Otočné kolečko
 RO Roata de carucior mobila
 H Szállítógörgök
 E Rueda giratoria con freno

TEMPERATURE TOLERANCE
 ODPORNOSC NA TEMPERATURE
 -10°C ÷ +50°C

RUBBER
 GUMA

ROLLER BEARING
 ŁO YSKO
 WALECZKOWE



No.	wheel diameter / średnica kółka (mm)	wheel width / szerokość kółka (mm)	caster height / wysokość kółka (mm)	load capacity / obciążalność (kg)	box
87311	75	23	97	40	48
87312	100	27	130	60	26
87313	125	34	155	100	20
87315	160	40	195	130	10
87317	200	46	235	150	6

PL Kółko skrętnie z czarną gumą
 GB Swivel caster
 D Lenkrolle mit Feststeller
 RUS Ролик с вращающейся опорой
 CZ Otočné kolečko
 RO Roata de carucior mobila
 H Szállítógörgök
 E Rueda giratoria con freno

TEMPERATURE TOLERANCE
 ODPORNOSC NA TEMPERATURE
 -10°C ÷ +50°C

RUBBER
 GUMA

DOUBLE BRAKE
 PODWÓJNY HAMULEC

ROLLER BEARING
 ŁO YSKO
 WALECZKOWE

THREADED STEM
 TRZPIE
 GWINTOWANY



No.	wheel diameter / średnica kółka (mm)	wheel width / szerokość kółka (mm)	caster height / wysokość kółka (mm)	load capacity / obciążalność (kg)	box
87331	75	22	97	40	38
87332	100	26	130	60	24
87333	125	33	153	100	18
87335	160	39	190	130	8
87337	200	44	230	150	6

PL Kółko skrętnie z szarą gumą
 GB Swivel caster
 D Lenkrolle mit Feststeller
 RUS Ролик с вращающейся опорой
 CZ Otočné kolečko
 RO Roata de carucior mobila
 H Szállítógörgök
 E Rueda giratoria con freno

TEMPERATURE TOLERANCE
 ODPORNOSC NA TEMPERATURE
 -10°C ÷ +50°C

RUBBER
 GUMA

PLAIN BEARING
 ŁO YSKO
 LISZCOWE



No.	wheel diameter / średnica kółka (mm)	wheel width / szerokość kółka (mm)	caster height / wysokość kółka (mm)	load capacity / obciążalność (kg)	box
87361	50	16	72	20	100
87362	75	21	104	30	52
87363	100	26	134	45	28
87364	125	27	161	50	24

PL Kółko skrętne z szarą gumą
GB Swivel caster
D Lenkrolle mit Feststeller
RUS Ролик с вращающийся опорой

CZ Otočné kolečko
RO Roata de carucior mobila
H Szállítógörgők
E Rueda giratoria con freno

TEMPERATURE TOLERANCE
ODPORNOŚĆ NA TEMPERATURĘ
-10°C ÷ +50°C

RUBBER
GUMA

BOLT HOLE
OTWOR
MOCUJĄCY

PLAIN BEARING
ŁO YSKO
LIZGOWE



No.	wheel diameter / średnica kółka (mm)	wheel width / szerokość kółka (mm)	caster height / wysokość kółka (mm)	load capacity / obciążalność (kg)	
87371	50	16	70	20	120
87372	75	21	101	30	64
87373	100	26	132	45	34
87374	125	27	158	50	24

PL Kółko stałe
GB Fixed caster
D Bockrolle
RUS Ролик с стационарной опорой

CZ Pevné kolečko
RO Roata de carucior fixa
H Szállítógörgők
E Rueda fija

TEMPERATURE TOLERANCE
ODPORNOŚĆ NA TEMPERATURĘ
-10°C ÷ +50°C

RUBBER
GUMA

POM BEARING
ŁO YSKO
POM



No.	wheel diameter / średnica kółka (mm)	wheel width / szerokość kółka (mm)	caster height / wysokość kółka (mm)	load capacity / obciążalność (kg)	
87391	40	17	54	20	280
87392	50	22	65	25	130
87393	65	23	84	30	90

PL Kółko skrętne
GB Swivel caster
D Lenkrolle mit Feststeller
RUS Ролик с вращающийся опорой

CZ Otočné kolečko
RO Roata de carucior mobila
H Szállítógörgők
E Rueda giratoria con freno

TEMPERATURE TOLERANCE
ODPORNOŚĆ NA TEMPERATURĘ
-10°C ÷ +50°C

RUBBER
GUMA

BRAKE
HAMULEC

POM BEARING
ŁO YSKO
POM



No.	wheel diameter / średnica kółka (mm)	wheel width / szerokość kółka (mm)	caster height / wysokość kółka (mm)	load capacity / obciążalność (kg)	
87411	40	17	54	20	230
87412	50	22	65	25	110
87413	65	23	84	30	72

PL Kółko czarna guma
GB Wheel
D Transportrad
RUS Ролик

CZ Kolečko
RO Roata de carucior
H Őnálló görgők
E Rueda



No.	wheel diameter / średnica kółka (mm)	wheel width / szerokość kółka (mm)	axle / oś	load capacity / obciążalność (kg)	
87451	75	22	Ø12mm x 30mm	40	150
87452	100	26	Ø12mm x 40mm	60	66
87453	125	33	Ø15mm x 40mm	100	36
87454	150	39	Ø20mm x 55mm	110	22
87455	160	39	Ø20mm x 55mm	130	20
87456	200	44	Ø20/25mm x 55mm	150	12
87457	250	48	Ø20/25mm x 55mm	180	8

PL Kółko skrętne z szarą gumą
GB Swivel caster
D Lenkrolle mit Feststeller
RUS Ролик с вращающийся опорой

CZ Otočné kolečko
RO Roata de carucior mobila
H Szállítógörgők
E Rueda giratoria con freno

TEMPERATURE TOLERANCE
ODPORNOŚĆ NA TEMPERATURĘ
-10°C ÷ +50°C

RUBBER
GUMA

BRAKE
HAMULEC

PLAIN BEARING
ŁO YSKO
LIZGOWE



No.	wheel diameter / średnica kółka (mm)	wheel width / szerokość kółka (mm)	caster height / wysokość kółka (mm)	load capacity / obciążalność (kg)	
87381	50	16	72	20	96
87382	75	21	104	30	50
87383	100	26	134	45	26
87384	125	27	161	50	22

PL Kółko skrętne
GB Swivel caster
D Lenkrolle mit Feststeller
RUS Ролик с вращающийся опорой

CZ Otočné kolečko
RO Roata de carucior mobila
H Szállítógörgők
E Rueda giratoria con freno

TEMPERATURE TOLERANCE
ODPORNOŚĆ NA TEMPERATURĘ
-10°C ÷ +50°C

RUBBER
GUMA

POM BEARING
ŁO YSKO
POM



No.	wheel diameter / średnica kółka (mm)	wheel width / szerokość kółka (mm)	caster height / wysokość kółka (mm)	load capacity / obciążalność (kg)	
87401	40	17	54	20	260
87402	50	22	65	25	120
87403	65	23	84	30	78

PL Kółko skrętne
GB Swivel caster
D Lenkrolle mit Feststeller
RUS Ролик с вращающийся опорой

CZ Otočné kolečko
RO Roata de carucior mobila
H Szállítógörgők
E Rueda giratoria con freno

TEMPERATURE TOLERANCE
ODPORNOŚĆ NA TEMPERATURĘ
-15°C ÷ +80°C

POLYAMIDE
POLIAMID

ROLLER BEARING
ŁO YSKO
WALECOWE



No.	wheel diameter / średnica kółka (mm)	wheel width / szerokość kółka (mm)	caster height / wysokość kółka (mm)	load capacity / obciążalność (kg)	
87431	75	23	97	40	60
87432	100	31	130	60	32
87433	125	33	155	100	26
87435	160	40	195	130	12
87437	200	40	235	150	8

PL Uszczelka do okien i drzwi
GB Seal for windows and doors
D Dichtung für Fenster und Türen
RUS Уплотнители для окон и дверей

CZ Těsnění oken a dveří
RO Seal pt. ferestre si usi
H Seal az ablakok és ajtók
E Sellar para ventanas y puertas



No.	dimensions / wymiary (mm)	L (m)	type / profil	colour / kolor	☐
76752	9x7.4	6	D	○	24
76762	9x7.4	6	D	●	24

PL Uszczelka do okien i drzwi
GB Seal for windows and doors
D Dichtung für Fenster und Türen
RUS Уплотнители для окон и дверей

CZ Těsnění oken a dveří
RO Seal pt. ferestre si usi
H Seal az ablakok és ajtók
E Sellar para ventanas y puertas

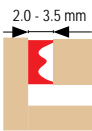

No.	dimensions / wymiary (mm)	L (m)	type / profil	colour / kolor	☐
76750	9x4	6	E	○	24
76760	9x4	6	E	●	24

PL Uszczelka do okien i drzwi
GB Seal for windows and doors
D Dichtung für Fenster und Türen
RUS Уплотнители для окон и дверей

CZ Těsnění oken a dveří
RO Seal pt. ferestre si usi
H Seal az ablakok és ajtók
E Sellar para ventanas y puertas

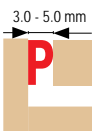

No.	dimensions / wymiary (mm)	L (m)	type / profil	colour / kolor	☐
76751	9x5.5	6	P	○	24
76761	9x5.5	6	P	●	24

PL Podkładka samoprzylepna, korkowa
GB Self-adhesive pad for furniture
D Klebegleiter für Möbel
RUS Самоклеящая подкладка под мебель

CZ Podložka samolepící pod nábytek
RO Adeziv pad sub mobilier
H Öntapadó, bútortábl alátét
E Arandela adhesiva bajo los muebles



No.	Ø (mm)	pcs	☐
74802	20	20	60/720
74804	28	12	60/720

PL Uszczelka do okien i drzwi
GB Seal for windows and doors
D Dichtung für Fenster und Türen
RUS Уплотнители для окон и дверей

CZ Těsnění oken a dveří
RO Seal pt. ferestre si usi
H Seal az ablakok és ajtók
E Sellar para ventanas y puertas

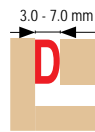

No.	dimensions / wymiary (mm)	L (m)	type / profil	colour / kolor	☐
76757	9x7.4	100	D	○	6
76767	9x7.4	100	D	●	6

PL Uszczelka do okien i drzwi
GB Seal for windows and doors
D Dichtung für Fenster und Türen
RUS Уплотнители для окон и дверей

CZ Těsnění oken a dveří
RO Seal pt. ferestre si usi
H Seal az ablakok és ajtók
E Sellar para ventanas y puertas

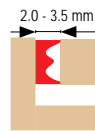

No.	dimensions / wymiary (mm)	L (m)	type / profil	colour / kolor	☐
76755	9x4	150	E	○	6
76765	9x4	150	E	●	6

PL Uszczelka do okien i drzwi
GB Seal for windows and doors
D Dichtung für Fenster und Türen
RUS Уплотнители для окон и дверей

CZ Těsnění oken a dveří
RO Seal pt. ferestre si usi
H Seal az ablakok és ajtók
E Sellar para ventanas y puertas

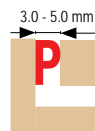

No.	dimensions / wymiary (mm)	L (m)	type / profil	colour / kolor	☐
76756	9x5.5	100	P	○	6
76766	9x5.5	100	P	●	6

PL Podkładka samoprzylepna, korkowa
GB Self-adhesive pad for furniture
D Klebegleiter für Möbel
RUS Самоклеящая подкладка под мебель

CZ Podložka samolepící pod nábytek
RO Adeziv pad sub mobilier
H Öntapadó, bútortábl alátét
E Arandela adhesiva bajo los muebles

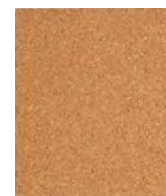

No.	mm	pcs	☐
74812	100x120	1	60/720

- PL Podkładka samoprzylepna, antypoślizgowa
 GB Self-adhesive pad for furniture
 D Klebegleiter für Möbel
 RUS Самоклеящая подкладка под мебель
- CZ Podložka samolepicí pod nábytek
 RO Adeziv pad sub mobilier
 H Öntapadó, bútorláb alátét
 E Arandela adhesiva bajo los muebles



VOREL

No.	Ø (mm)	pcs	
74816	10	24	60/720
74818	20	20	60/720
74820	28	12	60/720

- PL Podkładka samoprzylepna z włókniny
 GB Self-adhesive pad for furniture
 D Klebegleiter für Möbel
 RUS Самоклеящая подкладка под мебель
- CZ Podložka samolepicí pod nábytek
 RO Adeziv pad sub mobilier
 H Öntapadó, bútorláb alátét
 E Arandela adhesiva bajo los muebles



VOREL

No.	Ø (mm)	pcs	
74831	20	20	60/720
74833	28	12	60/720
74835	40	4	60/720

- PL Podkładka samoprzylepna z włókniny
 GB Self-adhesive pad for furniture
 D Klebegleiter für Möbel
 RUS Самоклеящая подкладка под мебель
- CZ Podložka samolepicí pod nábytek
 RO Adeziv pad sub mobilier
 H Öntapadó, bútorláb alátét
 E Arandela adhesiva bajo los muebles



VOREL

No.	mm	pcs	
74841	20x20	20	60/720
74843	28x28	12	60/720

- PL Podkładka samoprzylepna z włókniny
 GB Self-adhesive pad for furniture
 D Klebegleiter für Möbel
 RUS Самоклеящая подкладка под мебель
- CZ Podložka samolepicí pod nábytek
 RO Adeziv pad sub mobilier
 H Öntapadó, bútorláb alátét
 E Arandela adhesiva bajo los muebles



VOREL

No.	mm	pcs	
74849	100x120	1	60/720

- PL Podkładka samoprzylepna, antypoślizgowa
 GB Self-adhesive pad for furniture
 D Klebegleiter für Möbel
 RUS Самоклеящая подкладка под мебель
- CZ Podložka samolepicí pod nábytek
 RO Adeziv pad sub mobilier
 H Öntapadó, bútorláb alátét
 E Arandela adhesiva bajo los muebles



VOREL

No.	mm	pcs	
74828	100x120	1	60/720

- PL Podkładka samoprzylepna z włókniny mix
 GB Self-adhesive pad for furniture
 D Klebegleiter für Möbel
 RUS Самоклеящая подкладка под мебель
- CZ Podložka samolepicí pod nábytek
 RO Adeziv pad sub mobilier
 H Öntapadó, bútorláb alátét
 E Arandela adhesiva bajo los muebles



VOREL

No.	Ø (mm)	pcs	
74838	20; 38	12	60/720

- PL Podkładka samoprzylepna z włókniny
 GB Self-adhesive pad for furniture
 D Klebegleiter für Möbel
 RUS Самоклеящая подкладка под мебель
- CZ Podložka samolepicí pod nábytek
 RO Adeziv pad sub mobilier
 H Öntapadó, bútorláb alátét
 E Arandela adhesiva bajo los muebles



VOREL

No.	mm	pcs	
74846	20x45	10	60/720

- PL Podkładka samoprzylepna z włókniny mix
 GB Self-adhesive pad for furniture
 D Klebegleiter für Möbel
 RUS Самоклеящая подкладка под мебель
- CZ Podložka samolepicí pod nábytek
 RO Adeziv pad sub mobilier
 H Öntapadó, bútorláb alátét
 E Arandela adhesiva bajo los muebles



VOREL

No.	Ø (mm)	pcs	
74858	20; 38	12	60/720

PL Podkładka samoprzylepna z włókniny
GB Self-adhesive pad for furniture
D Klebegleiter für Möbel
RUS Самоклеящая подкладка под мебель

CZ Podložka samolepicí pod nábytek
RO Adeziv pad sub mobilier
H Őntapadó, bútorláb alátét
E Arandela adhesiva bajo los muebles

NONWOVEN
WŁOKNINA



VOREL

No.	mm	pcs	
74861	20x20	20	60/720
74863	28x28	12	60/720

PL Podkładka samoprzylepna z włókniny
GB Self-adhesive pad for furniture
D Klebegleiter für Möbel
RUS Самоклеящая подкладка под мебель

CZ Podložka samolepicí pod nábytek
RO Adeziv pad sub mobilier
H Őntapadó, bútorláb alátét
E Arandela adhesiva bajo los muebles

NONWOVEN
WŁOKNINA



VOREL

No.	mm	pcs	
74866	20x45	10	60/720

PL Podkładka samoprzylepna, antypoślizgowa
GB Self-adhesive pad for furniture
D Klebegleiter für Möbel
RUS Самоклеящая подкладка под мебель

CZ Podložka samolepicí pod nábytek
RO Adeziv pad sub mobilier
H Őntapadó, bútorláb alátét
E Arandela adhesiva bajo los muebles

NON-SLIP
ANTY-
PO ŹLIZGOWY



VOREL

No.	Ø (mm)	pcs	
74882	25	18	24/432

PL Podkładka samoprzylepna, silikonowa
GB Self-adhesive silicone pad for furniture
D Klebegleiter für Möbel
RUS Самоклеящая подкладка под мебель

CZ Podložka samolepicí pod nábytek
RO Adeziv pad sub mobilier
H Őntapadó, bútorláb alátét
E Arandela adhesiva bajo los muebles

SILICONE
SILIKON



VOREL

No.	Ø (mm)	pcs	
74910	8	25	32/576
74911	10	20	32/576
74912	13	12	32/576
74913	15	9	32/576
74914	19	6	32/576

PL Podkładka samoprzylepna z włókniny
GB Self-adhesive pad for furniture
D Klebegleiter für Möbel
RUS Самоклеящая подкладка под мебель

CZ Podložka samolepicí pod nábytek
RO Adeziv pad sub mobilier
H Őntapadó, bútorláb alátét
E Arandela adhesiva bajo los muebles

NONWOVEN
WŁOKNINA



VOREL

No.	Ø (mm)	pcs	
74851	20	20	60/720
74853	28	12	60/720
74855	40	4	60/720
74856	50	2	60/720

PL Podkładka samoprzylepna z włókniny
GB Self-adhesive pad for furniture
D Klebegleiter für Möbel
RUS Самоклеящая подкладка под мебель

CZ Podložka samolepicí pod nábytek
RO Adeziv pad sub mobilier
H Őntapadó, bútorláb alátét
E Arandela adhesiva bajo los muebles

NONWOVEN
WŁOKNINA



VOREL

No.	mm	pcs	
74869	100x120	1	60/720

PL Podkładka samoprzylepna, antypoślizgowa
GB Self-adhesive pad for furniture
D Klebegleiter für Möbel
RUS Самоклеящая подкладка под мебель

CZ Podložka samolepicí pod nábytek
RO Adeziv pad sub mobilier
H Őntapadó, bútorláb alátét
E Arandela adhesiva bajo los muebles

NON-SLIP
ANTY-
PO ŹLIZGOWY



VOREL

No.	Ø (mm)	pcs	
74885	18	32	24/432
74886	25	18	24/432
74887	38	8	24/432

SILICONE
SILIKON



- PL Podkładki plastikowo-filcowe na gwóźdź
- GB Felt & plastic furniture glides
- D Kunststoff- und Filzgleiter zum Nageln
- RUS Подкладки пластиковые фильцевые на гвоздь
- CZ Plastové podložky s plstí na hřebík
- RO Șaibe din plastic-pâslă pt. cuie
- H Műanyag-filc alátét szőghöz
- E Arandelas de plástico y fieltro con clave



No.	Ø (mm)	pcs	
74920	17	16	16/288
74921	20	12	16/288
74922	24	12	16/288
74923	28	8	16/256
74924	30	8	16/256

- PL Klíny pod meble
- GB Levelling wedge
- D Keile für Möbel
- RUS Клинья под мебель
- CZ Klíny pod nábytek
- RO Pene pt. mobilă
- H Butorék
- E Cuña para muebles



No.	pcs	
74960	4	16/288

- PL Stolek plastikowy
- GB Plastic stool
- D Kunststoff Hocker
- RUS Пластиковый табурет
- CZ Plastová stolička
- RO Scaun de plastic
- H Műanyag széklét
- E Taburete de plástico



No.	size / rozmiar (cm)	
75916	30x20x21	10/20

- PL Podkładki plastikowe na gwóźdź
- GB Plastic furniture glides
- D Kunststoffgleiter zum Nageln
- RUS Подкладки пластиковые на гвоздь
- CZ Plastové podložky na hřebík
- RO Șaibe din plastic pt. cuie
- H Műanyag alátét szőghöz
- E Arandelas de plástico con clave



No.	Ø (mm)	pcs	
74935	18	12	16/288
74936	20	12	16/288
74937	25	8	16/288

- PL Stolek plastikowy
- GB Plastic stool
- D Kunststoff Hocker
- RUS Пластиковый табурет
- CZ Plastová stolička
- RO Scaun de plastic
- H Műanyag széklét
- E Taburete de plástico



No.	size / rozmiar (cm)	
75915	30x20x21	10/20

- PL Haczyki naścienne samoprzylepne
- GB Self-adhesive hanging hooks
- D Selbstklebende Wandhaken
- RUS Крючки настенные на липучках
- CZ Háčky nástěnné samolepící
- RO Cârlițe perete autocolante
- H Műanyag, falí kampó, öntapadós
- E Ganchos adhesivos para pared



No.	max (kg)	pcs	
74730	1.0	3	12/144

PL Haczyki naścienne samoprzylepne
GB Self-adhesive hanging hooks
D Selbstklebende Wandhaken
RUS Крючки настенные на липучках
CZ Háčky nástěnné samolepící
RO Cărlige perete autocolante
H Műanyag, fali kampó, öntapadós
E Ganchos adhesivos para pared



VOREL

No.	max (kg)	pcs	
74732	1.0	3	12/192

PL Haczyki naścienne samoprzylepne
GB Self-adhesive hanging hooks
D Selbstklebende Wandhaken
RUS Крючки настенные на липучках

CZ Háčky nástěnné samolepící
RO Cărlige perete autocolante
H Műanyag, fali kampó, öntapadós
E Ganchos adhesivos para pared



VOREL

No.	max (kg)	pcs	
74733	0.8	4	12/192

PL Haczyki naścienne samoprzylepne
GB Self-adhesive hanging hooks
D Selbstklebende Wandhaken
RUS Крючки настенные на липучках

CZ Háčky nástěnné samolepící
RO Cărlige perete autocolante
H Műanyag, fali kampó, öntapadós
E Ganchos adhesivos para pared



VOREL

No.	max (kg)	pcs	
74740	0.6	3	12/216

PL Haczyki naścienne samoprzylepne
GB Self-adhesive hanging hooks
D Selbstklebende Wandhaken
RUS Крючки настенные на липучках

CZ Háčky nástěnné samolepící
RO Cărlige perete autocolante
H Műanyag, fali kampó, öntapadós
E Ganchos adhesivos para pared



VOREL

No.	max (kg)	pcs	
74744	1.0	2	8/144

PL Haczyki naścienne samoprzylepne
GB Self-adhesive hanging hooks
D Selbstklebende Wandhaken
RUS Крючки настенные на липучках
CZ Háčky nástěnné samolepící
RO Cărlige perete autocolante
H Műanyag, fali kampó, öntapadós
E Ganchos adhesivos para pared



VOREL

No.	max (kg)	pcs	
74731	0.8	3	18/216

PL Haczyki naścienne samoprzylepne
GB Self-adhesive hanging hooks
D Selbstklebende Wandhaken
RUS Крючки настенные на липучках
CZ Háčky nástěnné samolepící
RO Cărlige perete autocolante
H Műanyag, fali kampó, öntapadós
E Ganchos adhesivos para pared



VOREL

No.	max (kg)	pcs	
74734	0.4	6	16/192

PL Haczyki naścienne samoprzylepne
GB Self-adhesive hanging hooks
D Selbstklebende Wandhaken
RUS Крючки настенные на липучках

CZ Háčky nástěnné samolepící
RO Cărlige perete autocolante
H Műanyag, fali kampó, öntapadós
E Ganchos adhesivos para pared



VOREL

No.	max (kg)	pcs	
74741	1.5	2	12/216

PL Haczyki naścienne samoprzylepne
GB Self-adhesive hanging hooks
D Selbstklebende Wandhaken
RUS Крючки настенные на липучках
CZ Háčky nástěnné samolepící
RO Cărlige perete autocolante
H Műanyag, fali kampó, öntapadós
E Ganchos adhesivos para pared



VOREL

No.	max (kg)	pcs	
74750	1.0	2	16/192

- PL Haczyki naścienne samoprzylepne
 GB Self-adhesive hanging hooks
 D Selbstklebende Wandhaken
 RUS Крючки настенные на липучках
 CZ Háčky nástěnné samolepící
 RO Cârlițe perete autocolante
 H Műanyag, fali kampó, öntapadós
 E Ganchos adhesivos para pared

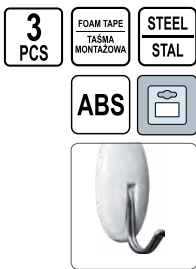

No.	max (kg)	pcs	
74751	0.8	3	16/192

- PL Haczyki naścienne samoprzylepne
 GB Self-adhesive hanging hooks
 D Selbstklebende Wandhaken
 RUS Крючки настенные на липучках
 CZ Háčky nástěnné samolepící
 RO Cârlițe perete autocolante
 H Műanyag, fali kampó, öntapadós
 E Ganchos adhesivos para pared

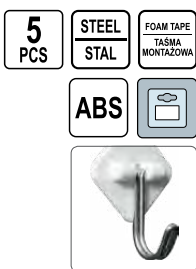

No.	max (kg)	pcs	
74753	0.4	5	16/288

- PL Haczyki naścienne na wkręt
 GB Wall hooks with screws
 D Wandhaken zum Anschrauben
 RUS Крючки настенные на шурупах
 CZ Háčky nástěnné na šroub
 RO Cârlițe perete cu șurub
 H Műanyag, fali kampó, csavaros
 E Ganchos atornillados para pared



No.	max (kg)	pcs	
74766	8.0	3	12/192

- PL Ochraniacze na narożniki meblowe
 GB Corner cushions
 D Eckenschoner für Möbel
 RUS Насадки на углы мебели
- CZ Chráníče na rohy nábytku
 RO Protecție colțuri mobilă
 H Bútor sarokvédő
 E Protectores esquineros para muebles



No.	pcs	
74772	4	16/288

- PL Haczyki naścienne samoprzylepne
 GB Self-adhesive hanging hooks
 D Selbstklebende Wandhaken
 RUS Крючки настенные на липучках
 CZ Háčky nástěnné samolepící
 RO Cârlițe perete autocolante
 H Műanyag, fali kampó, öntapadós
 E Ganchos adhesivos para pared

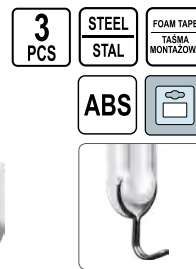

No.	max (kg)	pcs	
74752	1.2	3	18/216

- PL Haczyki naścienne na wkręt
 GB Wall hooks with screws
 D Wandhaken zum Anschrauben
 RUS Крючки настенные на шурупах
- CZ Háčky nástěnné na šroub
 RO Cârlițe perete cu șurub
 H Műanyag, fali kampó, csavaros
 E Ganchos atornillados para pared



No.	max (kg)	pcs	
74765	5.0	3	16/256

- PL Ochraniacze na narożniki meblowe
 GB Corner cushions
 D Eckenschoner für Möbel
 RUS Насадки на углы мебели
- CZ Chráníče na rohy nábytku
 RO Protecție colțuri mobilă
 H Bútor sarokvédő
 E Protectores esquineros para muebles



No.	pcs	
74771	4	16/288

- PL Ochraniacze na narożniki meblowe
 GB Corner cushions
 D Eckenschoner für Möbel
 RUS Насадки на углы мебели
- CZ Chráníče na rohy nábytku
 RO Protecție colțuri mobilă
 H Bútor sarokvédő
 E Protectores esquineros para muebles



No.	pcs	
74773	4	12/144

- PL Zabezpieczenie otwarcia drzwi meblowych
 GB Multi-purpose latches
 D Schutzisierung gegen das Öffnen der Möbeltüren
 RUS Блокатор открывания дверей мебели
 CZ Pojistka proti otevření nábytkových dveří
 RO Protecție deschidere ușii mobilă
 H Bútorajtó-útköző
 E Protectores para las portezuelas de muebles para prevenir su apertura



VOREL

No.	pcs	
74775	2	16/256

- PL Zabezpieczenie odkręcania kurków kuchennych
 GB Oven knob covers
 D Schutz gegen das Abdrehen von Küchenhähnen
 RUS Блокатор открывания кухонных кранов
 CZ Pojistka proti otevření kuchyňských kohoutků
 RO Protecție desfacere mâneră bucatărie
 H Gáztűzhely csapjának kinyitása ellen védő sapka
 E Protectores para las llaves de cocina para prevenir su apertura

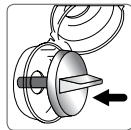

VOREL

No.	pcs	
74777	2	8/96

- PL Hak CZ Hák
 GB Hook RO Cârlig
 D Haken H Kampó
 RUS Крюк E Gancho



No.	L (mm)	pcs	
78451	300	30	30/120

- PL Wieszaki montowane do ściany CZ Věšáky na montáž do stěny
 GB Storage hangers set RO Cârlige montate pe perete
 D Montagehaken für die Wand H Falra szerelhető akasztó
 RUS Крючки на стену E Ganchos para paredes



VOREL

No.	Ø (mm)	pcs	
74681	9	2	12/108

- PL Zabezpieczenie otwarcia drzwi meblowych
 GB Multi-purpose latches
 D Schutzisierung gegen das Öffnen der Möbeltüren
 RUS Блокатор открывания дверей мебели
 CZ Pojistka proti otevření nábytkových dveří
 RO Protecție deschidere ușii mobilă
 H Bútorajtó-útköző
 E Protectores para las portezuelas de muebles para prevenir su apertura



VOREL

No.	pcs	
74776	2	12/126

- PL Hak CZ Hák
 GB Hook RO Cârlig
 D Haken H Kampó
 RUS Крюк E Gancho



No.	L (mm)	pcs	
78450	300	30	30/120

- PL Wieszaki montowane do ściany CZ Věšáky na montáž do stěny
 GB Storage hangers set RO Cârlige montate pe perete
 D Montagehaken für die Wand H Falra szerelhető akasztó
 RUS Крючки на стену E Ganchos para paredes



VOREL

No.	Ø (mm)	pcs	
74680	6	4	24/96

- PL Wieszaki montowane do ściany CZ Věšáky na montáž do stěny
 GB Storage hangers set RO Cârlige montate pe perete
 D Montagehaken für die Wand H Falra szerelhető akasztó
 RUS Крючки на стену E Ganchos para paredes



VOREL

No.	Ø (mm)	pcs	
74682	11	2	12/48

PL Wieszaki montowane do ściany
GB Storage hangers set
D Montagehaken für die Wand
RUS Крючки на стену

CZ Věšáky na montáž do stěny
RO Cărlige montate pe perete
H Falra szerelhető akasztó
E Ganchos para paredes

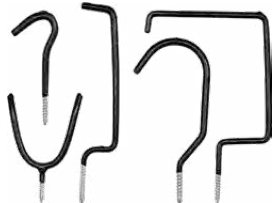

5 pcs
Ø 6 mm
15 kg (max)
PVC COATED POWŁOKA



No.	Ø (mm)	pcs	
74688	6	5	24/96

PL Klipsy do przewodów
GB Cable clips
D Kabelspangen
RUS Скобы для кабеля

CZ Spony na kabely
RO Cleme pt. cabluri
H Kábelrögzítő
E Clips para cables

TPR



No.	size / rozmiar (mm)	pcs	
74973	25x25x10	6	25/300
74974	37x35x15	4	25/200
74975	60x50x25	2	25/200

PL Wieszaki montowane do ściany
GB Storage hangers set
D Montagehaken für die Wand
RUS Крючки на стену

CZ Věšáky na montáž do stěny
RO Cărlige montate pe perete
H Falra szerelhető akasztó
E Ganchos para paredes

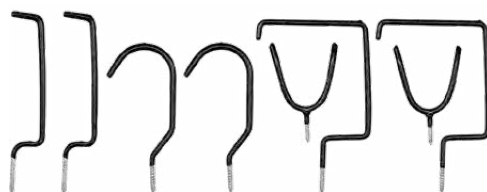

8 pcs
Ø 6 mm
15 kg (max)
PVC COATED POWŁOKA



No.	Ø (mm)	pcs	
74689	6	8	12/48

PL Organizer gumowy „żółwik”
GB Rubber organizer „turtle”
D Gummiorganizer „Schildkröte”
RUS Резиновый организер для проводов «черепашка»

CZ Gumový organizér „želvička”
RO Organizator de cauciuc „broască țestoasă”
H Gumi „teknősbéka” kábelrendező
E Organizador de caucho tipo „tortuga”

1m (max)
POWER OF COILED CABLE
TWO TIMES
MINIMUM TWO
1250 W

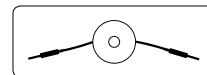

No.	
74983	25/300

A large grid of graph paper for taking notes, consisting of approximately 30 columns and 40 rows of small squares.

Memo

22

Health & safety products
Artykuły BHP



Gloves
Rękawice

.....360-363

Goggles & shields
Okulary i osłony przeciwodpryskowe

.....363-364

Dust masks
Maski przeciwpyłowe

.....364-365

Welding goggles & masks
Okulary i maski spawalnicze

.....365-368

Knee pads
Nakolanniki

.....368-369

Hearing protectors
Nauszniki przeciwhałasowe

.....369

Safety helmets
Kaski ochronne

.....369

Rain boots
Kalosze

.....370-371

Working shoes
Buty robocze

.....372

Safety sandals

Sandaly robocze..... 372

Shoes accessories
Akcesoria do obuwia

.....372

Working clothes
Odzież robocza

.....372-373

Safety vests

Kamizelki ostrzegawcze..... 372

Waterproof jackets

Kurtki przeciwdeszczowe..... 373

PL Rękawice robocze CZ Pracovní rukavice
 GB Working gloves RO Mănuși
 D Arbeitshandschuh H Védőkesztyű
 RUS Перчатки E Guantes



No.		
74094		240

PL Rękawice robocze
 GB Working gloves
 D Arbeitshandschuh
 RUS Перчатки
 CZ Pracovní rukavice
 RO Mănuși
 H Védőkesztyű
 E Guantes



No.	pairs / pary	size / rozmiar	
74102	1	8	10/240

PL Rękawice robocze
 GB Working gloves
 D Arbeitshandschuh
 RUS Перчатки
 CZ Pracovní rukavice
 RO Mănuși
 H Védőkesztyű
 E Guantes



No.	pairs / pary	packing	
74106	1		10/240

PL Rękawice robocze
 GB Working gloves
 D Arbeitshandschuh
 RUS Перчатки
 CZ Pracovní rukavice
 RO Mănuși
 H Védőkesztyű
 E Guantes



No.	pairs / pary	size / rozmiar	
74110	1	9	12/300

PL Rękawice robocze
 GB Working gloves
 D Arbeitshandschuh
 RUS Перчатки
 CZ Pracovní rukavice
 RO Mănuși
 H Védőkesztyű
 E Guantes



No.	pairs / pary	
74100	1	12/300

PL Rękawice robocze
 GB Working gloves
 D Arbeitshandschuh
 RUS Перчатки
 CZ Pracovní rukavice
 RO Mănuși
 H Védőkesztyű
 E Guantes



No.	
74104	10/240

PL Rękawice robocze CZ Pracovní rukavice
 GB Working gloves RO Mănuși
 D Arbeitshandschuh H Védőkesztyű
 RUS Перчатки E Guantes

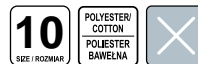

No.	
74108	240

PL Rękawice robocze
 GB Working gloves
 D Arbeitshandschuh
 RUS Перчатки
 CZ Pracovní rukavice
 RO Mănuși
 H Védőkesztyű
 E Guantes



No.	size / rozmiar	
74125	8	12/300
74130	9	12/300
74131	10	12/300

PL Rękawice robocze
GB Working gloves
D Arbeitshandschuh
RUS Перчатки
CZ Pracovní rukavice
RO Mănuși
H Védőkesztyű
E Guantes



FLO

No.	size / rozmiar	
74126	8	12/300
74132	9	12/300
74133	10	12/300

PL Rękawice robocze
GB Working gloves
D Arbeitshandschuh
RUS Перчатки
CZ Pracovní rukavice
RO Mănuși
H Védőkesztyű
E Guantes



FLO

No.	size / rozmiar	
74128	8	12/300
74136	9	12/300
74137	10	12/300

PL Rękawice ogrodnicze
GB Gardening gloves
D Arbeitshandschuh
RUS Перчатки

CZ Pracovní rukavice
RO Mănuși
H Védőkesztyű
E Guantes



FLO

No.	size / rozmiar	
74121	8	50/1000

PL Rękawice ogrodnicze
GB Gardening gloves
D Arbeitshandschuh
RUS Перчатки

CZ Pracovní rukavice
RO Mănuși
H Védőkesztyű
E Guantes



FLO

No.	size / rozmiar	
74113	8	50/1000

PL Rękawice robocze
GB Working gloves
D Arbeitshandschuh
RUS Перчатки
CZ Pracovní rukavice
RO Mănuși
H Védőkesztyű
E Guantes



FLO

No.	size / rozmiar	
74127	8	12/300
74134	9	12/300
74135	10	12/300

PL Rękawice ogrodnicze
GB Gardening gloves
D Arbeitshandschuh
RUS Перчатки

CZ Pracovní rukavice
RO Mănuși
H Védőkesztyű
E Guantes



FLO

No.	size / rozmiar	
74117	8	50/1000

PL Rękawice ogrodnicze
GB Gardening gloves
D Arbeitshandschuh
RUS Перчатки

CZ Pracovní rukavice
RO Mănuși
H Védőkesztyű
E Guantes



FLO

No.	size / rozmiar	
74123	8	50/1000

PL Rękawice ogrodnicze
GB Gardening gloves
D Arbeitshandschuh
RUS Перчатки

CZ Pracovní rukavice
RO Mănuși
H Védőkesztyű
E Guantes



FLO

No.	size / rozmiar	
74115	8	50/1000

PL Rękawice robocze
GB Working gloves
D Arbeitshandschuh
RUS Перчатки
CZ Pracovní rukavice
RO Mănuși
H Védőkesztyű
E Guantes



No.	
74150	12/120

PL Rękawice robocze
GB Working gloves
D Arbeitshandschuh
RUS Перчатки
CZ Pracovní rukavice
RO Mănuși
H Védőkesztyű
E Guantes



No.	
74160	12/120

PL Rękawice robocze
GB Working gloves
D Arbeitshandschuh
RUS Перчатки
CZ Pracovní rukavice
RO Mănuși
H Védőkesztyű
E Guantes



No.	size / rozmiar	
74146	10	12/120

PL Rękawice robocze
GB Working gloves
D Arbeitshandschuh
RUS Перчатки
CZ Pracovní rukavice
RO Mănuși
H Védőkesztyű
E Guantes



No.	size / rozmiar	
74079	9	12/120
74080	10	12/120

PL Rękawice robocze
GB Working gloves
D Arbeitshandschuh
RUS Перчатки
CZ Pracovní rukavice
RO Mănuși
H Védőkesztyű
E Guantes



No.	
74151	12/120

PL Rękawice robocze
GB Working gloves
D Arbeitshandschuh
RUS Перчатки
CZ Pracovní rukavice
RO Mănuși
H Védőkesztyű
E Guantes



No.	
74162	600

PL Rękawice robocze
GB Working gloves
D Arbeitshandschuh
RUS Перчатки
CZ Pracovní rukavice
RO Mănuși
H Védőkesztyű
E Guantes



No.	pairs / pary	size / rozmiar	
74145	12	10	10

PL Rękawice robocze
GB Working gloves
D Arbeitshandschuh
RUS Перчатки
CZ Pracovní rukavice
RO Mănuși
H Védőkesztyű
E Guantes

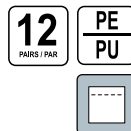

No.	pairs / pary	size / rozmiar	
74077	12	9	10
74078	12	10	10

PL Rękawice robocze
GB Working gloves
D Arbeitshandschuh
RUS Перчатки
CZ Pracovní rukavice
RO Mănuși
H Védőkesztyű
E Guantes

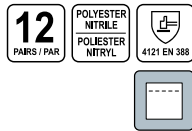

No.	pairs / pary	size / rozmiar	
74152	12	8	240
74153	12	9	240
74154	12	10	240

PL Rękawice ochronne, ocieplane
GB Insulated gloves
D Isolierhandschuhe
RUS Утепленные перчатки

CZ Zimní rukavice
RO Mănuși izolate
H Szigetelt kesztyű
E Gants isolés

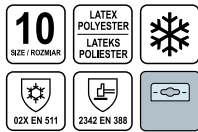

No.	size / rozmiar	
74148	10	12/120

PL Rękawice robocze
GB Working gloves
D Arbeitshandschuh
RUS Перчатки
CZ Pracovní rukavice
RO Mănuși
H Védőkesztyű
E Guantes



No.	size / rozmiar	
74060	10	10/120

PL Oslona twarzy przeciwdpryskowa
GB Polycarbonate protection shield
D Schutzmaske
RUS Маска защитная

CZ Ochranná přilba /polyuhličitan/
RO Mască protecție
H Hegesztősisak /polivenglán/
E Pantalla protectora antipedacitos



No.	
74459	25/50

PL Rękawice robocze ocieplane
GB Insulated gloves
D Arbeitshandschuh
RUS Перчатки
CZ Pracovní rukavice
RO Mănuși
H Védőkesztyű
E Guantes



No.	size / rozmiar	
74149	10	12/120

PL Rękawice robocze
GB Working gloves
D Arbeitshandschuh
RUS Перчатки
CZ Pracovní rukavice
RO Mănuși
H Védőkesztyű
E Guantes



No.	size / rozmiar	
74140	10	12/120

PL Rękawice robocze
GB Working gloves
D Arbeitshandschuh
RUS Перчатки
CZ Pracovní rukavice
RO Mănuși
H Védőkesztyű
E Guantes



No.	size / rozmiar	
74081	9	12/120
74082	10	12/120

PL Oslona twarzy przeciwdpryskowa
GB Polycarbonate protection shield
D Schutzmaske
RUS Маска защитная
CZ Ochranná přilba /polyuhličitan/
RO Mască protecție
H Hegesztősisak /polivenglán/
E Pantalla protectora antipedacitos



No.	
74460	20

PL Okulary ochronne CZ Ochranné brýle
 GB Safety glasses RO Ochelari pt. protectie
 D Schutzbrille H Védőszemüveg
 RUS Очки защитные открытые E Gafas protectoras



No.	type	
74501	TVS	12/240

PL Okulary ochronne CZ Ochranné brýle
 GB Safety glasses RO Ochelari pt. protectie
 D Schutzbrille H Védőszemüveg
 RUS Очки защитные открытые E Gafas protectoras



No.	type	
74503	DY-8525	12/240

PL Okulary ochronne CZ Ochranné brýle
 GB Safety glasses RO Ochelari pt. protectie
 D Schutzbrille H Védőszemüveg
 RUS Очки защитные открытые E Gafas protectoras



No.	type	
74508	HF-103	10/120

PL Półmaski filtrujące jednorazowe
 GB Disposable dust masks
 D Atemschutzmaske
 RUS Респиратор противопылевой одноразовый
 CZ Protiprašná maska
 RO Masca praf
 H Eldobható porvédőmaszk
 E Mascanilla desechable para protección contra polvo



No.	pcs	
74540	5	25/100

PL Okulary ochronne CZ Ochranné brýle
 GB Safety glasses RO Ochelari pt. protectie
 D Schutzbrille H Védőszemüveg
 RUS Очки защитные открытые E Gafas protectoras



No.	type	
74502	HF-110	12/240

PL Okulary ochronne CZ Ochranné brýle
 GB Safety glasses RO Ochelari pt. protectie
 D Schutzbrille H Védőszemüveg
 RUS Очки защитные открытые E Gafas protectoras



No.	type	
74504	DY-8526	15/150

PL Okulary ochronne CZ Ochranné brýle
 GB Safety glasses RO Ochelari pt. protectie
 D Schutzbrille H Védőszemüveg
 RUS Очки защитные открытые E Gafas protectoras



No.	type	
74509	HF-105	10/100

PL Półmaski filtrujące jednorazowe
 GB Disposable dust masks
 D Atemschutzmaske
 RUS Респиратор противопылевой одноразовый
 CZ Protiprašná maska
 RO Masca praf
 H Eldobható porvédőmaszk
 E Mascanilla desechable para protección contra polvo



No.	pcs	
74541	5	15/60

- PL Półmaski filtrujące jednorazowe
- GB Disposable dust masks
- D Atemschutzmaske
- RUS Респиратор противопылевой одноразовый
- CZ Protiprašná maska
- RO Masca praaf
- H Eldobható porvédőmaszk
- E Mascarilla desechable para protección contra polvo



No.	pcs	
74542	5	25/100

- PL Półmaska antysmogowa
- GB Anti pollution mask
- D Atemschutzmaske-Smogmaske
- RUS Антисмоговая полумаска
- CZ Ochranná maska proti znečišťování ovzduší
- RO Masca antipoluare
- H Eldobható porvédőmaszk, szelepes
- E Mascarilla desechable para



No.	type	
74555	VZ / PZ	50

- PL Okulary spawalnicze
- GB Welding goggles
- D Schweisserbrille
- RUS Очки газосварщика
- CZ Brýle svářečské
- RO Ochelari pt. sudura
- H Hegesztőszemüveg
- E Gafas para soldar



No.		
74410		5/100

- PL Maska spawalnicza
- GB Welding mask
- D Schweissermaske
- RUS Щиток сварщика
- CZ Svářečská maska
- RO Mască de sudură
- H Hegesztőpajzs
- E Mascara de soldador



No.	type	
74440	TSM-3	30

- PL Półmaski filtrujące jednorazowe
- GB Disposable dust masks
- D Atemschutzmaske
- RUS Респиратор противопылевой одноразовый
- CZ Protiprašná maska
- RO Masca praaf
- H Eldobható porvédőmaszk
- E Mascarilla desechable para protección contra polvo



No.	pcs	
74543	5	15/60

- PL Okulary spawalnicze
- GB Welding goggles
- D Schweisserbrille
- RUS Очки газосварщика
- CZ Brýle svářečské
- RO Ochelari pt. sudura
- H Hegesztőszemüveg
- E Gafas para soldar

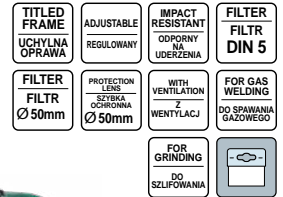

No.		
74400		25/100

- PL Okulary spawalnicze
- GB Welding goggles
- D Schweisserbrille
- RUS Очки газосварщика
- CZ Brýle svářečské
- RO Ochelari pt. sudura
- H Hegesztőszemüveg
- E Gafas para soldar



No.		
74411		10/100

- PL Maska spawalnicza
- GB Welding mask
- D Schweissermaske
- RUS Щиток сварщика
- CZ Svářečská maska
- RO Mască de sudură
- H Hegesztőpajzs
- E Mascara de soldador



No.	type	
74442	TSMM	30

PL Maska spawalnicza
GB Welding mask
D Schweissermaske
RUS Щиток сварщика
CZ Svářečská maska
RO Mască de sudură
H Hegesztőpajzs
E Mascara de soldador



FILTER SIZE
ROZMIAR
FILTRA
50x100
mm

SPECTACLE
LENS SIZE
ROZMIAR
SZKIEŁA
OCZKOWYCH
20x100 mm
(DIN 5)

222x372
x80 mm

FILTER
FILTR
DIN 10

WEIGHT
WITHOUT LENS
WAGA BEZ
SZKIEŁ
408 g

No.	type	
74443	TSMF	20

PL Przyłbica spawalnicza z podglądem
GB Welding mask
D Schweissermaske
RUS Щиток сварщика с подсмотром

CZ Svářečská přilba s nakoukáváním
RO Mască de sudură cu geam
H Hegesztősisak kitekintővel
E Mascara de soldador con mirador



FILTER SIZE
ROZMIAR
FILTRA
50x100 mm
DIN 8-13

SPECTACLE
LENS SIZE
ROZMIAR
SZKIEŁA
OCZKOWYCH
20x100 mm
(DIN 5)

195x265
x170 mm

FILTER
FILTR
DIN 10

WEIGHT
WITHOUT LENS
WAGA BEZ
SZKIEŁ
332 g

No.	type	
74447	PSMP	20

PL Maska spawalnicza
GB Welding mask
D Schweissermaske
RUS Щиток сварщика
CZ Svářečská maska
RO Mască de sudură
H Hegesztőpajzs
E Mascara de soldador



FILTER SIZE
ROZMIAR
FILTRA
110x90
mm

FILTER
FILTR
DIN 12



No.		
74441		20

PL Przyłbica spawalnicza
GB Welding helmet
D Schweissermaske
RUS Щиток сварщика

CZ Svářečská maska
RO Mască de sudură
H Hegesztőpajzs
E Mascara de soldador



No.		
74449		12

PL Maska spawalnicza
GB Welding mask
D Schweissermaske
RUS Щиток сварщика
CZ Svářečská maska
RO Mască de sudură
H Hegesztőpajzs
E Mascara de soldador



FILTER SIZE
ROZMIAR
FILTRA
50x100
mm

257x450
x96 mm

WEIGHT
WITHOUT LENS
WAGA BEZ
SZKIEŁ
455 g

No.	type	
74450	TSD-3	20

PL Przyłbica spawalnicza z podglądem
GB Welding mask
D Schweissermaske
RUS Щиток сварщика с подсмотром

CZ Svářečská přilba s nakoukáváním
RO Mască de sudură cu geam
H Hegesztősisak kitekintővel
E Mascara de soldador con mirador



FILTER SIZE
ROZMIAR
FILTRA
50x100 mm
DIN 8-13

SPECTACLE
LENS SIZE
ROZMIAR
SZKIEŁA
OCZKOWYCH
20x100 mm
(DIN 5)

225x290
x175 mm

FILTER
FILTR
DIN 10

WEIGHT
WITHOUT LENS
WAGA BEZ
SZKIEŁ
427 g

No.	type	
74448	PS-3	10

PL Przyłbica spawalnicza
GB Welding mask
D Schweissermaske
RUS Щиток сварщика

CZ Svářečská přilba s nakoukáváním
RO Mască de sudură cu geam
H Hegesztősisak kitekintővel
E Mascara de soldador con mirador



FILTER SIZE
ROZMIAR
FILTRA
110x90
mm

WELDING FILTER
FILTR
SPAWALNICZY
12



No.		
74457		20

FILTER SIZE
ROZMIAR
FILTRA
108x50
mm

WELDING FILTER
FILTR
SPAWALNICZY
10



- PL Przyłbica spawalnicza samościemniająca
- GB Auto-darkening welding helmet
- D Schweissmaske, selbstverdunkelnd
- RUS Маска для сварки, самостоятельно затемняющаяся
- CZ Svářečská kukla samostmívací
- RO Mască de sudură auto-întunecare
- H Őnmagától sötétedő hegesztőpajzs
- E Casco auto-obscurecedor para soldadura



9-13 DARK STATE STAN CIEMNY	4 LIGHT STATE STAN JASNY	REACTION TIME CZAS REAKCJI 1/15000 s
0.25 - 0.85 s BRIGHTENING TIME CZAS ROZJASNIANIA	0.25 - 0.8 ms DIMMING TIME CZAS ZACIEMNIENIA	92x42 VIEWING AREA POLE WIDZENIA
2 ARC SENSOR LICZKA CZUJNIKÓW ŁUKU	GRINDING WELDING SZLIFOWANIE SPRAWIANIE	SENSITIVITY CZUŁOŚĆ
SOLAR CELL OGNIWO SŁONECZNE	AUTOMATIC POWER ON/OFF AUTOMATYCZNE WŁĄCZENIE / WYŁĄCZENIE	DELAY OPÓZNIENIE
-5°C ~ +55°C WORKING TEMPERATURE TEMPERATURA PRACY	UV / IR	3 POINT HEADGEAR WIEŻBA 3 PUNKTOWA
	OPTICAL CHARACTERISTIC WŁA CIWÓ CI OPTYCZNE 1/1/1/2	



No.	
74480	6

- PL Przyłbica spawalnicza samościemniająca
- GB Auto-darkening welding helmet
- D Schweissmaske, selbstverdunkelnd
- RUS Маска для сварки, самостоятельно затемняющаяся
- CZ Vyměnitelný kryt z plastu
- RO Mască de sudură auto-întunecare
- H Őnmagától sötétedő hegesztőpajzs
- E Casco auto-obscurecedor para soldadura



100x50 VIEWING AREA POLE WIDZENIA	4 ARC SENSOR LICZKA CZUJNIKÓW ŁUKU	1/25000 REACTION TIME CZAS REAKCJI
0.1-1.0 s BRIGHTENING TIME CZAS ROZJASNIANIA	0.1-1.0 s DIMMING TIME CZAS ZACIEMNIENIA	DIN 11 DARK STATE STAN CIEMNY
DIN 3 LIGHT STATE STAN JASNY	UV / IR DIN 16	WELDING SPRAWIANIE MIG / MAG MMA / TIG
SOLAR CELL OGNIWO SŁONECZNE	BATTERY BATERIA 2x3V CR2032	AUTOMATIC POWER ON/OFF AUTOMATYCZNE WŁĄCZENIE / WYŁĄCZENIE
AUTOMATIC SENSITIVITY ADJUSTMENT AUTOMATYCZNA REGULACJA CZUŁOŚCI	-5°C ~ +55°C WORKING TEMPERATURE TEMPERATURA PRACY	3 POINT HEADGEAR WIEŻBA 3 PUNKTOWA
	OPTICAL CHARACTERISTIC WŁA CIWÓ CI OPTYCZNE 1/1/1/2	



No.	
74484	6

- PL Osłona wymienna z tworzywa
- GB PC visor
- D Austauschbare Abdeckung aus Kunststoff
- RUS Заменяемая защита из пластмассы
- CZ Vyměnitelný kryt z plastu
- RO Protecție schimbabilă din plastic
- H Cserélhető, műanyag pajzs
- E Protección reemplazable de materia plástica



No.	size (mm)	
74463	305x200	200
74464	395x200	150

- PL Przyłbica spawalnicza samościemniająca
- GB Auto-darkening welding helmet
- D Schweissmaske, selbstverdunkelnd
- RUS Маска для сварки, самостоятельно затемняющаяся
- CZ Svářečská kukla samostmívací
- RO Mască de sudură auto-întunecare
- H Őnmagától sötétedő hegesztőpajzs
- E Casco auto-obscurecedor para soldadura



90x35 VIEWING AREA POLE WIDZENIA	2 ARC SENSOR LICZKA CZUJNIKÓW ŁUKU	1/25000 REACTION TIME CZAS REAKCJI
0.4 s BRIGHTENING TIME CZAS ROZJASNIANIA	0.4 s DIMMING TIME CZAS ZACIEMNIENIA	DIN 11 DARK STATE STAN CIEMNY
DIN 3 LIGHT STATE STAN JASNY	UV / IR DIN 15	WELDING SPRAWIANIE MIG / MAG MMA / TIG
SOLAR CELL OGNIWO SŁONECZNE	BATTERY BATERIA 1x CR1025	-5°C ~ +55°C WORKING TEMPERATURE TEMPERATURA PRACY
OPTICAL CHARACTERISTIC WŁA CIWÓ CI OPTYCZNE 1/1/1/2	3 POINT HEADGEAR WIEŻBA 3 PUNKTOWA	



No.	
74483	6

- PL Przyłbica z osłoną wymienną
- GB Face shield with PC visor
- D Schweisserschutzhelm mit austauschbarer Abdeckung
- RUS Шлем с заменяемой защитой
- CZ Štít s vyměnitelným krytem
- RO Vizieră cu protecție schimbabilă
- H Arcvédő cserélhető pajzs
- E Antifaz con protección reemplazable



No.	
74461	40

- PL Przyłbica z osłoną wymienną i nasznikami przeciwhałasowymi
- GB Face shield with steel mesh and ear muff
- D Schweisserschutzhelm mit austauschbarer Abdeckung und Ohrenschützer gegen Lärm
- RUS Шлем с заменяемой защитой и наушниками против шума
- CZ Štít s vyměnitelným krytem a chrániči proti hluku
- RO Vizieră cu protecție schimbabilă și căști de protecție antigomot
- H Arcvédő cserélhető pajzs és fülvédő kagylóval
- E Antifaz con protección reemplazable y protectores de oídos

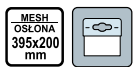

No.	
74462	40

PL Oslona filtra
GB Filter shield
D Filterabdeckung
RUS Кожух фильтра

CZ Ochrana filtru
RO Aparatoare de filtru
H Szűrőfedél
E Protección de filtro

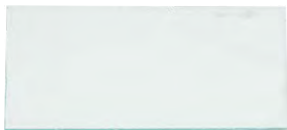

No.	mm	type / typ	
74451	50x100	DIN 0	150

PL Oslona filtra
GB Filter protection
D Filtereinsatz
RUS Кожух фильтра

CZ Ochranná folie filtru
RO Carcasă filtru
H Szűrő-védőburkolat
E Protección del filtro



No.	mm	type	for / dla	
74466	350x200	OT 1-N	74460	10/100

PL Nakolanniki
GB Knee pads
D Knieschützer
RUS Наколенники

CZ Chrániče kolen
RO Genunchiere
H Térdvédő
E Rodilleras



No.		
74600		50

PL Nakolanniki
GB Knee pads
D Knieschützer
RUS Наколенники

CZ Chrániče kolen
RO Genunchiere
H Térdvédő
E Rodilleras



No.		
74622		50

PL Filtr spawalniczy
GB Welding filter
D Vorsatzglas
RUS Фильтр для сварки

CZ Filtr svářečský
RO Filtru pt. sudării
H Hegesztőszűrő
E Pantalla de filtro de soldador



No.	mm	type / typ	
74452	50x100	DIN 8	100
74453	50x100	DIN 9	100
74454	50x100	DIN 10	100
74455	50x100	DIN 11	100

PL Oslona filtra przyłbicy samościemniającej
GB Self-dimming helmet filter protection
D Filtereinsatz eines selbstabdunkelnden Schutzhelms
RUS Кожух фильтра самозатемняющегося щитка
CZ Ochranná folie filtru samostmňujúcej kukly
RO Carcasă filtru vizieră heliomată
H Hegesztőpajzs szűrő, önsötétető
E Protección del filtro de visera autooscurecedora



No.	mm	pcs	
74439	90x110	5	20

PL Nakolanniki
GB Knee pads
D Knieschützer
RUS Наколенники

CZ Chrániče kolen
RO Genunchiere
H Térdvédő
E Rodilleras



No.		
74610		20

PL Nakolanniki
GB Knee pads
D Knieschützer
RUS Наколенники

CZ Chrániče kolen
RO Genunchiere
H Térdvédő
E Rodilleras



No.		
74624		12/24

PL Nakolanniki CZ Chrániče kolen
 GB Knee pads RO Genunchiere
 D Knieschützer H Térdvédő
 RUS Наколенники E Rodilleras



No.	
74601	24

PL Nakolanniki CZ Chrániče kolen
 GB Knee pads RO Genunchiere
 D Knieschützer H Térdvédő
 RUS Наколенники E Rodilleras



No.	
74603	6/24

PL Nauszniki przeciwhałasowe CZ Chrániče sluchu
 GB Ear muff RO Antifoane
 D Gehörschutz H Fülvédőt
 RUS Средства защиты слуха E Protectores de la vista



No.	
74580	60

PL Kask ochronny CZ Ochranná prilba
 GB Safety helmet RO Cască de protecție
 D Schutzhelm H Védősisak
 RUS Каска защитная E Casco de protección



No.	colour / kolor	
74190		40
74191		40
74192		40
74193		40
74194		40
74195		40

PL Nakolanniki CZ Chrániče kolen
 GB Knee pads RO Genunchiere
 D Knieschützer H Térdvédő
 RUS Наколенники E Rodilleras



No.	
74602	6/36

PL Nakolanniki - wkładki CZ Chrániče kolen
 GB Knee pads RO Genunchiere
 D Knieschützer H Térdvédő
 RUS Наколенники E Rodilleras

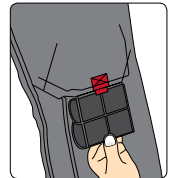

No.	
74595	60

PL Nauszniki przeciwhałasowe CZ Chrániče sluchu
 GB Ear muff RO Antifoane
 D Gehörschutz H Fülvédőt
 RUS Средства защиты слуха E Protectores de la vista



No.	
74581	10/60



PL Kalosze damskie
GB Women's rain boots
D Damen - Gummistiefel
RUS Галоши женские

CZ Dámské galoše
RO Cizme damă
H Női gumicsizma
E Chanclos para mujer



Jemar

No.	size / rozmiar	model	
72831	36	LUNA	7
72832	37	LUNA	7
72833	38	LUNA	7
72834	39	LUNA	5
72835	40	LUNA	5
72836	41	LUNA	5

PL Kalosze męskie
GB Men's rain boots
D Herren - Gummistiefel
RUS Галоши мужские

CZ Pánské galoše
RO Cizme bărbați
H Férfi gumicsizma
E Chanclos para hombre



Jemar

No.	size / rozmiar	model	
72881	40	FARMER	4
72882	41	FARMER	4
72883	42	FARMER	4
72884	43	FARMER	4
72885	44	FARMER	4
72886	45	FARMER	4
72887	46	FARMER	4
72888	47	FARMER	4

PL Kalosze męskie
GB Men's rain boots
D Herren - Gummistiefel
RUS Галоши мужские

CZ Pánské galoše
RO Cizme bărbați
H Férfi gumicsizma
E Chanclos para hombre



Jemar

No.	size / rozmiar	model	
72858	41	GRAND BLACK	8
72859	42	GRAND BLACK	8
72860	43	GRAND BLACK	8
72861	44	GRAND BLACK	8
72862	45	GRAND BLACK	6
72863	46	GRAND BLACK	6
72864	47	GRAND BLACK	6

PL Kalosze męskie
GB Men's rain boots
D Herren - Gummistiefel
RUS Галоши мужские

CZ Pánské galoše
RO Cizme bărbați
H Férfi gumicsizma
E Chanclos para hombre

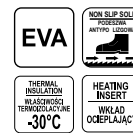

Jemar

No.	size / rozmiar	model	
72840	41	PREDATOR XL	4
72841	42	PREDATOR XL	4
72842	43	PREDATOR XL	4
72843	44	PREDATOR XL	4
72844	45	PREDATOR XL	4
72845	46	PREDATOR XL	4
72846	47	PREDATOR XL	4

PL Kalosze damskie
GB Women's rain boots
D Damen - Gummistiefel
RUS Галоши женские

CZ Dámské galoše
RO Cizme damă
H Női gumicsizma
E Chanclos para mujer



Jemar

No.	size / rozmiar	model	
72850	36	RAINNY BLACK	10
72851	37	RAINNY BLACK	10
72852	38	RAINNY BLACK	10
72853	39	RAINNY BLACK	10
72854	40	RAINNY BLACK	10

PL Buty gumowo - filcowe
GB Felt PVC boots
D Gummistiefel mit Filtz
RUS Сапоги резиновые с войлоком

CZ Holinky s filcem
RO Cizme PVC
H Gumi - filc csizma
E Botas de goma fieltro



Jemar

No.	size / rozmiar	
72871	40	6
72872	41	6
72873	42	6
72874	43	6
72875	44	6
72876	45	6
72877	46	5

PL Kalosze damskie
GB Women's rain boots
D Damen - Gummistiefel
RUS Галоши женские

CZ Dámské galoše
RO Cizme damă
H Női gumicsizma
E Chanclos para mujer



No.	size / rozmiar	
73931	36	7
73932	37	7
73933	38	7
73934	39	7
73935	40	7
73936	41	7

PL Kalosze damskie
GB Women's rain boots
D Damen - Gummistiefel
RUS Галоши женские

CZ Dámské galoše
RO Cizme damă
H Női gumicsizma
E Chanclos para mujer



No.	size / rozmiar	
73945	37	5
73946	38	5
73947	39	5

PL Buty gumowo-filcowe
GB Felt PVC boots
D Gummistiefel mit Filz
RUS Сапоги резиновые с войлоком

CZ Holínky s filcem
RO Cizme PVC
H Gumi - filc csizma
E Botas de goma fieltro



No.	size / rozmiar	
73958	40	5
73959	41	5
73960	42	5
73961	43	5
73962	44	5
73963	45	5
73964	46	5

PL Kalosze męskie
GB Men's rain boots
D Herren - Gummistiefel
RUS Галоши мужские

CZ Pánské galoše
RO Cizme bărbați
H Férfi gumicsizma
E Chanclos para hombre



No.	size / rozmiar	
73937	41	5
73938	42	5
73939	43	5
73940	44	5
73941	45	5
73942	46	5
73943	47	5

PL Kalosze męskie
GB Men's rain boots
D Herren - Gummistiefel
RUS Галоши мужские

CZ Pánské galoše
RO Cizme bărbați
H Férfi gumicsizma
E Chanclos para hombre



No.	size / rozmiar	
73950	41	5
73951	42	5
73952	43	5
73953	44	5
73954	45	5
73955	46	5

PL Kalosze męskie
GB Men's rain boots
D Herren - Gummistiefel
RUS Галоши мужские

CZ Pánské galoše
RO Cizme bărbați
H Férfi gumicsizma
E Chanclos para hombre



No.	size / rozmiar	
73966	40	5
73967	41	5
73968	42	5
73969	43	5
73970	44	5
73971	45	5
73972	46	5
73973	47	5

PL Sandały robocze CZ Pracovní polobotky
GB Safety sandals RO Bocanci de lucru
D Arbeitshalbschuhe H Munkavédelmi félcipő
RUS Полуботинки рабочие E Zapato de trabajo



No.	size / rozmiar	model	☐
72801	39	SALTA	10
72802	40	SALTA	10
72803	41	SALTA	10
72804	42	SALTA	10
72805	43	SALTA	10
72806	44	SALTA	10
72807	45	SALTA	10
72808	46	SALTA	10
72809	47	SALTA	10

PL Płynny tuszcz do obuwia
GB Oil spray
D Wartungs-Spray Schuhe
RUS Жидкий жир для обуви
CZ Olejový spray na obuv
RO Spray intretinere incaltaminte
H Cipőápoló olaj
E Aceite para botas



No.	ml	☐
72890	150	20

PL Antybakteryjna wkładka do butów CZ Antibakteriální vložka do bot
GB Antibacterial insole RO Tălpici antibacterieni
D Antibakterielle Einlage für Schuhe H Antibakteriális cipőbetét
RUS Антибактериальная стелька E Plantilla antibacterial

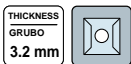

No.	size / rozmiar	thickness / grubość (mm)	☐
72683	39 / 40	3.2	50
72684	41 / 42	3.2	50
72685	43 / 44	3.2	50
72686	45 / 46	3.2	50

PL Sandały robocze CZ Pracovní polobotky
GB Safety sandals RO Bocanci de lucru
D Arbeitshalbschuhe H Munkavédelmi félcipő
RUS Полуботинки рабочие E Zapato de trabajo



No.	size / rozmiar	model	☐
72821	39	SERRA	10
72822	40	SERRA	10
72823	41	SERRA	10
72824	42	SERRA	10
72825	43	SERRA	10
72826	44	SERRA	10
72827	45	SERRA	10
72828	46	SERRA	10
72829	47	SERRA	10

PL Spray ożywiający kolor do nubuku i zamszu
GB Ravvivant spray
D Wildleder und Nubuk Pflegespray
RUS Спрей освежающий цвет nubuku и замши
CZ Spray na semišovou obuv
RO Spray revitalizant incaltaminte
H Nubukvelourápoló spray
E Spray para suede



No.	ml	☐
72891	250	20

PL Kamizelka ostrzegawcza CZ Výstražná vesta
GB Reflective vest RO Vestă de avertizare
D Warnweste H Fényviszverő mellény
RUS Жилет безопасности E chaleco reflectante

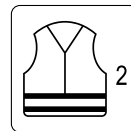

No.	size / rozmiar	model	☐
74660	L	VEST-O	100
74661	XL	VEST-O	100
74662	XXL	VEST-O	100
74663	XXXL	VEST-O	100

PL Kamizelka ostrzegawcza CZ Výstražná vesta
 GB Reflective vest RO Vestă de avertizare
 D Warnweste H Fényvisszaverő mellény
 RUS Жилет безопасности E Chaleco reflectante

100%
POLYESTER

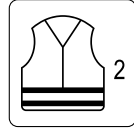

No.	size / rozmiar	model	
74664	L	VEST-G	100
74665	XL	VEST-G	100
74666	XXL	VEST-G	100
74667	XXXL	VEST-G	100

PL Plaszcz przeciwdeszczowy
 GB Raincoat
 D Regenmantel
 RUS Дождевик
 CZ Pláštěnka
 RO Pelerina ploaie
 H Esőkabát
 E Impermeable

70% PVC
30% POLYESTER



No.	size / rozmiar	
74631	XL	10
74632	XXL	10
74633	XXXL	10

PL Kurtka przeciwdeszczowa CZ Bunda do deště
 GB Waterproof jacket RO Giacă impermeabilă
 D Regenjacke H Vízhatlan dzseki
 RUS Куртка-дождевик E Chaqueta impermeable

70% PVC
30% POLYESTER



No.	size / rozmiar	
74626	L	20
74627	XXL	20
74628	XXXL	20

PL Komplet przeciwdeszczowy moro CZ Oblek maskáčový do deště
 GB Rain suit military style RO Îmbrăcămintă de ploaie camuflaj
 D Regenbekleidung militärischen Stil H Eső ruházat
 RUS Дождь костюмы военный стиль E Ropa de lluvia camo

30% PVC
70% POLYESTER



No.	size / rozmiar	
74646	L	20
74647	XXL	20

Memo	
------	--

23

Electric products
Artykuły elektryczne

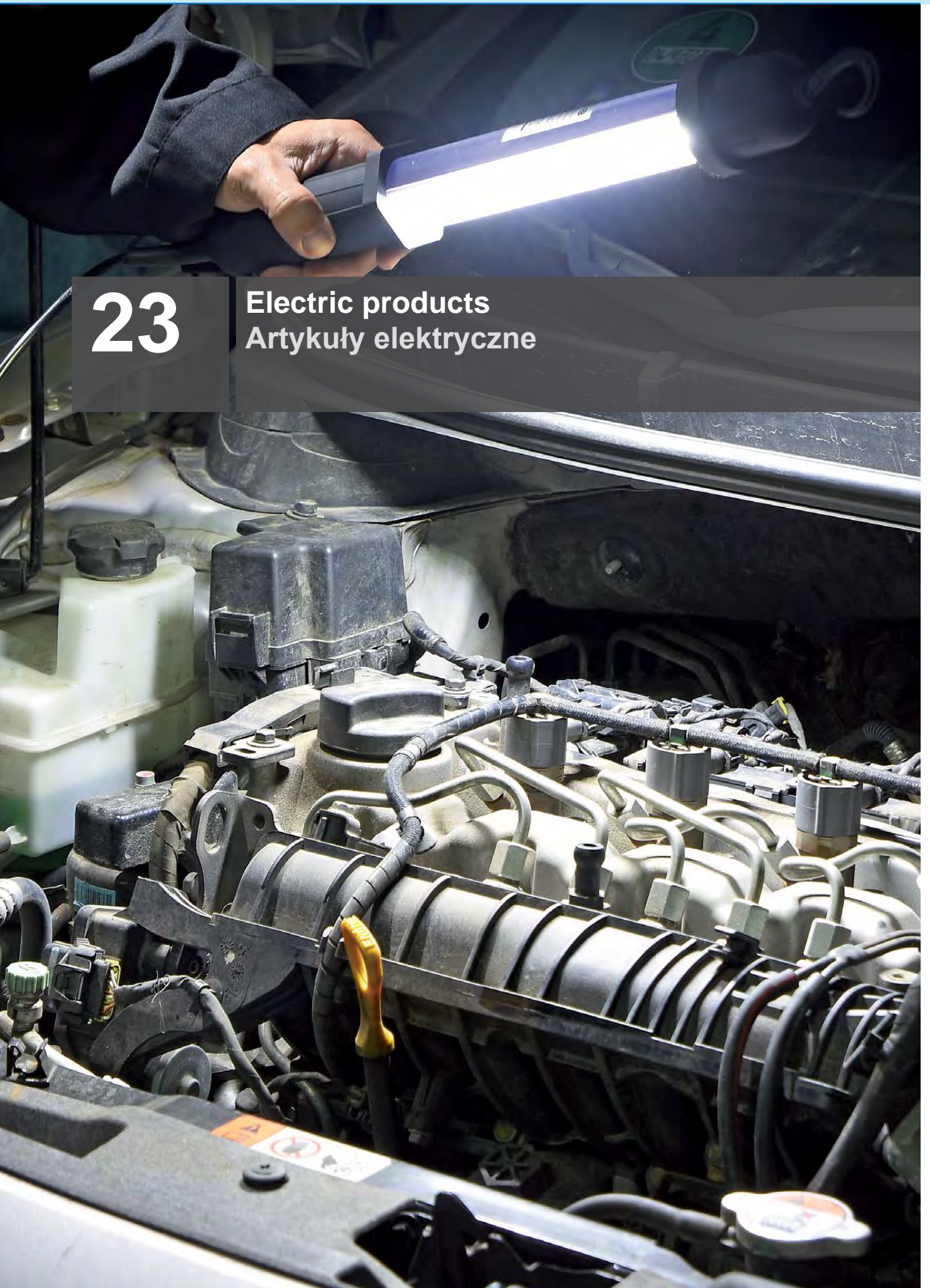

Extension cords & cable reels
Przedłużacze listwowe
i bębnowe

.....376-377

Extension cords French type

Przedłużacze elektryczne z uziemieniem..... 376

Extension cords

Przedłużacze elektryczne bez uziemienia..... 376

Christmas tree extension cables

Przedłużacze choinkowe..... 377

Cable reels French type

Przedłużacze bębnowe z uziemieniem..... 377

Adaptors
Rozgałęźniki

.....377-378

Lamps
Lampy

.....378-385

Halogen projectors

Lampy halogenowe..... 378

Halogen bulbs

Żarniki do lamp halogenowych..... 378

LED floodlights

Naświetlacze LED..... 379

Workshop lamps

Lampy warsztatowe..... 380

LED flashlights

Latarki diodowe..... 383

Bicycle lamps

Lampy rowerowe..... 385

Motion detectors
Czujniki ruchu

.....385-386



PL Przedłużacz elektryczny z uziemieniem
 GB Cord extension with earthing
 D Tischsteckdose Bolzenanschl
 RUS Удлинитель электрический с заземлением
 CZ Elektrický prodloužovač
 RO Prelungitor electric
 H Elektromos hosszabbító
 E Extensión electr.



No.	L (m)	☺	type	☐
72500	1.5	3	E	12/48
72501	1.5	4	E	12/48
72504	3.0	3	E	12/48
72505	3.0	4	E	12/48
72506	3.0	5	E	12/48
72508	5.0	3	E	12/48
72509	5.0	4	E	12/48
72510	5.0	5	E	12/48

PL Przedłużacz elektryczny z wyłącznikiem
 GB Cord extension with switch
 D Tischsteckdose
 RUS Удлинитель электрический с выключателем
 CZ Elektrický prodloužovač
 RO Prelungitor electric
 H Elektromos hosszabbító
 E Extensión para arbol de navidad verde

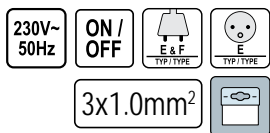

No.	L (m)	☺	type	☐
72524	1.5	3	E	12/48
72525	1.5	4	E	12/48
72526	1.5	5	E	12/48
72527	1.5	6	E	12/48
72528	3.0	3	E	12/48
72529	3.0	4	E	12/48
72530	3.0	5	E	12/48
72531	3.0	6	E	12/48
72532	5.0	3	E	12/48
72533	5.0	4	E	12/48
72534	5.0	5	E	12/48
72535	5.0	6	E	12/48

PL Przedłużacz elektryczny bez uziemienia
 GB Cord extension without earthing
 D Tischsteckdose ohne Nulleitung
 RUS Удлинитель электрический без заземления

CZ Elektrický prodloužovač
 RO Prelungitor electric
 H Elektromos hosszabbító
 E Extensión electr.



No.	L (m)	☺	type	☐
72484	1.5	3	C	12/48
72486	1.5	4	C	12/48
72489	3.0	3	C	12/48
72490	3.0	4	C	12/48
72493	5.0	3	C	12/48
72494	5.0	4	C	12/48

PL Przedłużacz elektryczny z uziemieniem
 GB Cord extension with earthing
 D Tischsteckdose Bolzenanschl
 RUS Удлинитель электрический с заземлением
 CZ Elektrický prodloužovač
 RO Prelungitor electric
 H Elektromos hosszabbító
 E Extensión electr.

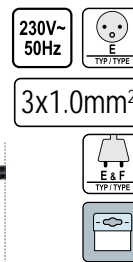

No.	L (m)	☺	type	☐
72615	1.5	3	E	12/48
72616	3.0	3	E	12/48
72617	5.0	3	E	12/48
72620	1.5	4	E	12/48
72621	3.0	4	E	12/48
72622	5.0	4	E	12/48

PL Przedłużacz elektryczny z uziemieniem
 GB Cord extension with earthing
 D Tischsteckdose Bolzenanschl
 RUS Удлинитель электрический с заземлением
 CZ Elektrický prodloužovač
 RO Prelungitor electric
 H Elektromos hosszabbító
 E Extensión electr.

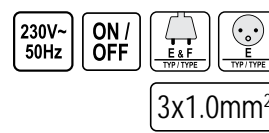

No.	L (m)	☺	type	☐
72625	1.5	3	E	12/48
72626	3.0	3	E	12/48
72627	5.0	3	E	12/48
72630	1.5	4	E	12/48
72631	3.0	4	E	12/48
72632	5.0	4	E	12/48



PL Przedłużacz
GB Garden extension cable
D Gartenverlängerungskabel
RUS Электродлинитель

CZ Prodlužovací kabel zahradní
RO Prelungitor electric
H Kerti hosszabbító
E Cable de extensión para jardín

230V~50Hz
IP20
2x1.0mm²



No.	L (m)	
82671	10	10
82673	20	10
82675	30	5
82677	40	5

PL Przedłużacz zielony
GB Christmas tree extension cable
D Christbaum Verlängerungskabel
RUS Удлинитель

CZ Elektrický prodloužovač
RO Prelungitor electric
H Elektromos hosszabbító
E Extensión para árbol de navidad verde

2x0.75mm²
230V~50Hz



No.	L (m)	
72451	3	10
72452	5	10

PL Przedłużacz bębnowy
GB Cable reel
D Kabeltrommel
RUS Удлинитель на катушке
CZ Bubnový prodloužovač
RO Prelungitor pe tambur
H Kábeldob
E Cable de prolongación de tambor



230V~50Hz
OVERHEAT PROTECTION
BEZPEČNÍK TERMČNÝ
CHILDREN PROTECTION
OCHRANA PŘED DĚTMI



No.	L (m)	wire gauge / průřez průvodu (mm ²)		type	
82682	25	3x1.0	4	E	2
82684	40	3x1.0	4	E	2
82685	50	3x1.5	4	E	2

PL Rozgaleźnik
GB Adapter
D Abzweigung
RUS Разветвитель

CZ Rozdvojka
RO Splitter
H Osztó
E Enchufe múltiple

230V~50Hz
16A



No.		type	
72404	2	E	100

PL Przedłużacz
GB Garden extension cable
D Gartenverlängerungskabel
RUS Электродлинитель

CZ Prodlužovací kabel zahradní
RO Prelungitor electric
H Kerti hosszabbító
E Cable de extensión para jardín

230V~50Hz
10m
2x1.0mm²



No.	L (m)	
72455	10	10

PL Przedłużacz zwijany
GB Cable reel
D Kabeltrommel Bolzenanschl
RUS Удлинитель электрический
CZ Bubnový prodloužovač
RO Prelungitor pe tambur
H Kábeldob
E Extensión electr.



PVC



No.	L (m)	wire gauge / průřez průvodu (mm ²)		type	
72570	15	3x1.0	4	E	4
72572	25	3x1.0	4	E	4
72573	30	3x1.5	4	E	4

PL Przedłużacz bębnowy
GB Cable reel
D Kabeltrommel
RUS Удлинитель на катушке
CZ Bubnový prodloužovač
RO Prelungitor pe tambur
H Kábeldob
E Cable de prolongación de tambor



230V~50Hz
OVERHEAT PROTECTION
BEZPEČNÍK TERMČNÝ
CHILDREN PROTECTION
OCHRANA PŘED DĚTMI



No.	L (m)	wire gauge / průřez průvodu (mm ²)		type	
82691	15	3x1.0	4	E	4
82692	25	3x1.0	4	E	2
82693	40	3x1.0	4	E	1
82694	50	3x1.5	4	E	1

PL Rozgaleźnik
GB Adapter
D Abzweigung
RUS Разветвитель

CZ Rozdvojka
RO Splitter
H Osztó
E Enchufe múltiple

230V~50Hz
16A



No.		type	
72407	3	E	100

- PL Rozgałęźnik
GB Adapter
D Abzweigung
RUS Разветвитель
- CZ Rozdvojka
RO Splitter
H Osztó
E Enchufe múltiple



No.	☺	type	☐
72400	2	C&E&F	200
72401	3	C&E&F	100
72402	4	C&E&F	100

- PL Lampa halogenowa przenośna
GB Portable halogen projector
D Halogenstrahler
RUS Проектор галогенный переносный
CZ Halogenové svítidlo přenosné
RO Lampa cu halogen mobilă
H Hordozható halogén lámpa
E Lámpara de halogeno portátil



No.	W	cabl / kabel (m)	☐
82788*	120	1.7	12
82789*	400	1.7	8

- PL Lampa halogenowa na stojaku
GB Halogen projector on tripod
D Halogenstrahler mit Stativ
RUS Проектор галогенный на штативе
CZ Halogenové svítidlo na stojanu
RO Lampa cu halogen pe stativ
H Állványos halogén lámpa
E Lámpara de halogeno sobre estante



No.	W	pcs	☐
82787*	400	2	4

- PL Lampa halogenowa
GB Halogen lamp
D Halogenstrahler
RUS Галогенная фара-прожектор
- CZ Halogenové svítidlo
RO Lampa cu halogen
H Halogén lámpa
E Lámpara de halogeno



No.	W	☐
82790*	120	24
82791*	400	16

- PL Lampa halogenowa na stojaku
GB Halogen projector on tripod
D Halogenstrahler mit Stativ
RUS Проектор галогенный на штативе
CZ Halogenové svítidlo na stojanu
RO Lampa cu halogen pe stativ
H Állványos halogén lámpa
E Lámpara de halogeno sobre estante



No.	W	☐
82786*	400	4

- PL Żarniki do lamp halogenowych
GB Halogen projector bulbs
D Halogenstab
RUS Галогенная трубка
- CZ Žárovka do halogenové lampy
RO Bec cu halogen pt. proiector
H Halogén lámpaizzó
E Filamentos de bombillas halogenas



No.	W	lumens	h	☐
82771*	120	2200	1000	50/200
82772*	400	8600	1000	50/200



PL Reflektor diodowy CZ LED reflektor
 GB LED lamp RO Reflector diodă
 D Diodescheinwerfer H Diodas reflektor
 RUS Светодиодный прожектор E Reflector de diodos

10W 6000 K
 800 lm 230V~50Hz
 25000 h IP65



No.	W	lumens	h	⊠
82841*	10	800	25000	12

PL Reflektor diodowy CZ LED reflektor
 GB LED lamp RO Reflector diodă
 D Diodescheinwerfer H Diodas reflektor
 RUS Светодиодный прожектор E Reflector de diodos

30W 6000 K
 2400 lm 230V~50Hz
 25000 h IP65



No.	W	lumens	h	⊠
82843*	30	2400	25000	12

PL Reflektor diodowy z czujnikiem ruchu
 GB LED lamp with motion detector
 D Diodescheinwerfer mit Bewegungsmelder
 RUS Светодиодный прожектор с датчиком движения
 CZ LED reflektor se snimačem pohybu
 RO Reflector diodă cu senzor de mișcare
 H Diódás reflektor mozgásérzékelővel
 E Reflector de diodos con sensor de movimiento

10W 6000 K
 800 lm 230V~50Hz
 25000 h IP54
 10m



No.	W	lumens	h	⊠
82845*	10	800	25000	12

PL Reflektor diodowy CZ LED reflektor
 GB LED lamp RO Reflector diodă
 D Diodescheinwerfer H Diodas reflektor
 RUS Светодиодный прожектор E Reflector de diodos

20W 6000 K
 1600 lm 230V~50Hz
 25000 h IP65



No.	W	lumens	h	⊠
82842*	20	1600	25000	12

PL Reflektor diodowy CZ LED reflektor
 GB LED lamp RO Reflector diodă
 D Diodescheinwerfer H Diodas reflektor
 RUS Светодиодный прожектор E Reflector de diodos

50W 6000 K
 4000 lm 230V~50Hz
 25000 h IP65

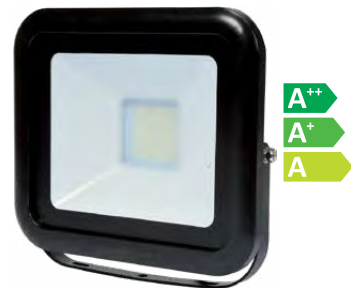

No.	W	lumens	h	⊠
82844*	50	4000	25000	12

PL Reflektor diodowy z czujnikiem ruchu
 GB LED lamp with motion detector
 D Diodescheinwerfer mit Bewegungsmelder
 RUS Светодиодный прожектор с датчиком движения
 CZ LED reflektor se snimačem pohybu
 RO Reflector diodă cu senzor de mișcare
 H Diódás reflektor mozgásérzékelővel
 E Reflector de diodos con sensor de movimiento

20W 6000 K
 1600 lm 230V~50Hz
 25000 h IP54
 10m



No.	W	lumens	h	⊠
82846*	20	1600	25000	12

- PL Reflektor diodowy z czujnikiem ruchu
- GB LED lamp with motion detector
- D Diodenscheinwerfer mit Bewegungsmelder
- RUS Светодиодный прожектор с датчиком движения
- CZ LED reflektor se snímačem pohybu
- RO Reflector diodă cu senzor de mișcare
- H Diódás reflektor mozgásérzékelővel
- E Reflector de diodos con sensor de movimiento

30W 6000 K
2400 lm 230V~50Hz
25000 h IP54
10m



A++
A+
A

SMD LED



No.	W	lumens	h	
82847*	30	2400	25000	12

- PL Diodowa lampa bezprzewodowa
- GB Rechargeable work lamp
- D Led Werkstattlampe
- RUS Светодиодная беспроводная лампа
- CZ Montážní lampa diodová bezpřívodová
- RO Lampa cu led fara cablu
- H Ledlámpa
- E Lámpara inalámbrica de diodos

A++
A+
A

12 LED 200 lm 4 h 4.5 h
12V 2000mAh Li-Ion 230V~50Hz BATTERY CHARGER LADÓWARKA 12V BATTERY CHARGER LADÓWARKA HOOK HAK MAGNETIC



SMD LED

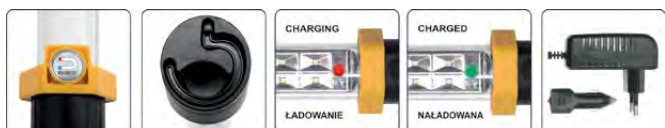

No.	LED	mAh	
82728*	12	2000	20

- PL Diodowa lampa bezprzewodowa
- GB Rechargeable work lamp
- D Led Werkstattlampe
- RUS Светодиодная беспроводная лампа
- CZ Montážní lampa diodová bezpřívodová
- RO Lampa cu led fara cablu
- H Ledlámpa
- E Lámpara inalámbrica de diodos

3W 200 lm 3.7V 2000mAh Li-Ion 12V BATTERY CHARGER LADÓWARKA FRONT LIGHTING FUNKCJA LATARKI 230V~50Hz BATTERY CHARGER LADÓWARKA MAGNETIC WORK TIME CZAS PRACY 4 h CHARGING TIME CZAS ŁADOWANIA 4 h HOOK HAK



COB LED

A++
A+
A



No.	W	mAh	
82719*	3	2000	20

- PL Reflektor diodowy z czujnikiem ruchu
- GB LED lamp with motion detector
- D Diodenscheinwerfer mit Bewegungsmelder
- RUS Светодиодный прожектор с датчиком движения
- CZ LED reflektor se snímačem pohybu
- RO Reflector diodă cu senzor de mișcare
- H Diódás reflektor mozgásérzékelővel
- E Reflector de diodos con sensor de movimiento

50W 6000 K
4000 lm 230V~50Hz
25000 h IP54
10m



A++
A+
A

SMD LED



No.	W	lumens	h	
82848*	50	4000	25000	12

- PL Diodowa lampa bezprzewodowa
- GB Rechargeable work lamp
- D Led Werkstattlampe
- RUS Светодиодная беспроводная лампа
- CZ Montážní lampa diodová bezpřívodová
- RO Lampa cu led fara cablu
- H Ledlámpa
- E Lámpara inalámbrica de diodos

30 LED 120 lm 6000K IP20 12V BATTERY CHARGER LADÓWARKA 230V~50Hz BATTERY CHARGER LADÓWARKA 3.7V 1200mAh Li-Ion 4.5 h 3 h HOOK HAK MAGNETIC



A++
A+
A



No.	LED	mAh	
82729*	30	1200	6/12

- PL Diodowa lampa bezprzewodowa
- GB Rechargeable work lamp
- D Led Werkstattlampe
- RUS Светодиодная беспроводная лампа
- CZ Montážní lampa diodová bezpřívodová
- RO Lampa cu led fara cablu
- H Ledlámpa
- E Lámpara inalámbrica de diodos

36 LED 3.7V 1200mAh Li-Ion 230V~50Hz BATTERY CHARGER LADÓWARKA 12V BATTERY CHARGER LADÓWARKA 4 h 4 h HOOK HAK MAGNETIC



A++
A+
A



No.	LED	mAh	
82720*	36	500	10/20

PL Lampa robocza LED
 GB LED work light
 D LED Handleuchte
 RUS Светодиодный светильник для мастерской
 CZ Ruční svítidla LED
 RO Lampa portabila cu LED
 H LED lámpa
 E Lámpara de taller LED



COB LED

3W 100 lm
 2 LIGHTING MODES TRYBY ŚWIĄCZENIA
 WORK TIME CZAS PRACY 4 h
 3.7V 800mAh Li-Ion
 Micro USB
 MAGNETIC
 HOOK HAK

2 tryby świecenia: 100%, 50%
 przytrzymanie przycisku: światło czerwone, pulsowanie, sos



No.	W	lumens	h	☐
82723*	3	100	4	12/48

PL Lampa robocza LED
 GB LED work light
 D LED Werkstattlampe
 RUS Светодиодный светильник для мастерской
 CZ Ruční svítidla LED
 RO Lampa portabila cu LED
 H LED lámpa
 E Lámpara de taller LED



SMD LED

230V~50Hz 400 lm 24 LED
 HOOK HAK 4.5 W 5.0m



No.	W	LED	☐
82706*	4.5	24	10/20

PL Lampa warsztatowa CZ Pracovní lampa
 GB Work light RO Lampă pt. atelier
 D Werkstattlampe H Szerelőlámpa
 RUS Лампа-переноска E Lámpara de taller



230V~50Hz E 27 60W 5.0m

No.	W	type	☐
82715*	60	„PLASTIC“	10

PL Lampa warsztatowa CZ Pracovní lampa
 GB Work light RO Lampă pt. atelier
 D Werkstattlampe H Szerelőlámpa
 RUS Лампа-переноска E Lámpara de taller



230V~50Hz E 27 5.0m

No.	W	type	☐
82716*	60	„GUMMI“	10
82717*	100	„GUMMI“	10

PL Lampa robocza LED
 GB LED work light
 D LED Werkstattlampe
 RUS Светодиодный светильник для мастерской
 CZ Ruční svítidla LED
 RO Lampa portabila cu LED
 H LED lámpa
 E Lámpara de taller LED



230V~50Hz 280 lm 16 LED
 HOOK HAK 3.2 W 5.0m

SMD LED



No.	W	LED	☐
82699*	3.2	16	10/20

PL Lampa warsztatowa CZ Pracovní lampa
 GB Work light RO Lampă pt. atelier
 D Werkstattlampe H Szerelőlámpa
 RUS Лампа-переноска E Lámpara de taller



230V~50Hz E 27 100 W 5.0m

No.	W	type	☐
82713*	100	„PRACTIC“	10

PL Lampa warsztatowa CZ Pracovní lampa
 GB Work light RO Lampă pt. atelier
 D Werkstattlampe H Szerelőlámpa
 RUS Лампа-переноска E Lámpara de taller



230V~50Hz E 27 60W 5.0m

No.	W	type	☐
82714*	60	„CLASSIC“	10

PL Lampa robocza LED
 GB LED work light
 D LED Handleuchte
 RUS Светодиодный светильник для мастерской
 CZ Ruční svítidla LED
 RO Lampa portabila cu LED
 H LED lámpa
 E Lámpara de taller LED



COB LED



No.	battery / bateria	☐
82724	3xAAA	12/48

PL Lampa robocza LED
 GB LED work light
 D LED Handleuchte
 RUS Светодиодный светильник для мастерской
 CZ Ruční svítidla LED
 RO Lampa portabila cu LED
 H LED lámpa
 E Lámpara de taller LED

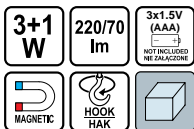

COB
LED



No.	LED	battery / bateria	box
82733	3+1	3xAAA	24/48

PL Lampa robocza LED
 GB LED work light
 D LED Handleuchte
 RUS Светодиодный светильник для мастерской
 CZ Ruční svítidla LED
 RO Lampa portabila cu LED
 H LED lámpa
 E Lámpara de taller LED



SMD
LED



No.	LED	battery / bateria	box
82731	24+3	3xAAA	12/48

PL Lampa robocza LED
 GB LED work light
 D LED Handleuchte
 RUS Светодиодный светильник для мастерской
 CZ Ruční svítidla LED
 RO Lampa portabila cu LED
 H LED lámpa
 E Lámpara de taller LED

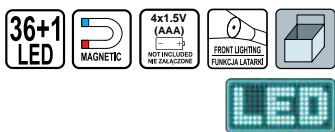

No.	LED	battery / bateria	box
82735	36+1	4xAAA	12/48

PL Lampa robocza LED
 GB LED work light
 D LED Handleuchte
 RUS Светодиодный светильник для мастерской
 CZ Ruční svítidla LED
 RO Lampa portabila cu LED
 H LED lámpa
 E Lámpara de taller LED

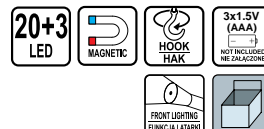

SMD
LED



No.	LED	battery / bateria	box
82730	20+3	3xAAA	12/48

PL Lampa robocza LED
 GB LED work light
 D LED Handleuchte
 RUS Светодиодный светильник для мастерской
 CZ Ruční svítidla LED
 RO Lampa portabila cu LED
 H LED lámpa
 E Lámpara de taller LED



COB
LED



No.	LED	battery / bateria	box
82726	COB	3xAAA	12/48

PL Lampa robocza LED
 GB LED work light
 D LED Handleuchte
 RUS Светодиодный светильник для мастерской
 CZ Ruční svítidla LED
 RO Lampa portabila cu LED
 H LED lámpa
 E Lámpara de taller LED



SMD
LED



No.	LED	battery / bateria	box
82742	6+1	3xAAA	12/48

- PL Chwytnak teleskopowy LED
- GB LED magnetic pick up tool
- D LED Magnet Heber
- RUS Захват магнитный телескопический с подсветкой
- CZ Patka magnetická teleskopická LED
- RO Telescop magnetic cu LED
- H LED felszedő mágnes teleszkópos nyéllel
- E Herramienta para levantar, telescopica, con LED



3 LED

17-56.5 cm
TELESCOPIC HANDLE
TELESKOPOWY UCHWYT

4xLR44
INCLUDED
W ZESTAWIE

LED



56.5 cm
17 cm

360°

LED



No.	LED	battery / bateria	
78405	3	3xAAA	12/48

- PL Latarka LED
- GB LED Flashlight
- D LED-Taschenlampe
- RUS Светодиодный фонарь
- CZ LED svítlna
- RO Lanterna cu LED
- H LED elemlámpa
- E Linterna LED

10W

500 lm

XM-L2

3x1.5 V (AAA)
NOT INCLUDED
NIE ZALĄCZONE

LED



No.	battery / bateria	
88560	3xAAA	12/24

- PL Latarka LED
- GB LED Flashlight
- D LED-Taschenlampe
- RUS Светодиодный фонарь
- CZ LED svítlna
- RO Lanterna cu LED
- H LED elemlámpa
- E Linterna LED

3W

150 lm

ZOOM

3x1.5 V (AAA)
NOT INCLUDED
NIE ZALĄCZONE

LED



No.	W	lumens	battery / bateria	
88550	3	150	3xAAA	12/48

- PL Zestaw latarka UV LED i okulary
- GB UV LED flashlight and glasses set
- D UV LED-Taschenlampe mit UV Schutzbrille
- RUS Комплект для проверки утечек хладагента - УФ фонарь 21-LED
- CZ UV LED svítlna + brýle
- RO Set lanterna UV LED si ochelari
- H UV LED zseblámpa + szemüveg
- E UV LED linterna con gafas para



21 LED

UV

395 nm

3x1.5 V (AAA)
NOT INCLUDED
NIE ZALĄCZONE

LED



No.	LED	battery / bateria	
82756	21	3xAAA	80

- PL Latarka LED
- GB LED Flashlight
- D LED-Taschenlampe
- RUS Светодиодный фонарь
- CZ LED svítlna
- RO Lanterna cu LED
- H LED elemlámpa
- E Linterna LED

5W

280 lm

ZOOM

3x1.5 V (AAA)
NOT INCLUDED
NIE ZALĄCZONE

LED



No.	battery / bateria	
88555	3xAAA	12/48

- PL Diodowa lampa warsztatowa akumulatorowa
- GB Workshop LED battery lamp
- D LED Akku-handleuchte
- RUS Светодиодная беспроводная лампа
- CZ Ruční svítlna LED
- RO Lampa portabila cu acumulator leduri
- H LED szerelő lámpák
- E Linterna LED recargable

3W

100 lm

10.8V 1300mAh Li-Ion

100-240V-50-60Hz BATTERY CHARGER ŁADOWNICA

BATTERY FOR: AKUMULATOR DLA: 78981

LED



No.	V	W	
78118*	10.8	3	8

PL Diodowa latarka czołowa
 GB Led work lamp
 D Stirntaschenlampe
 RUS Нало́бный светодио́дный фона́рь
 CZ Led montážní lampa - čelovka
 RO Lampa cu led
 H Led fejlámpa
 E Linterna de diodo

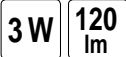

No.	battery / bateria	☐
88678	3xAAA	6/24

PL Diodowa latarka czołowa
 GB Led work lamp
 D Stirntaschenlampe
 RUS Нало́бный светодио́дный фона́рь
 CZ Led montážní lampa - čelovka
 RO Lampa cu led
 H Led fejlámpa
 E Linterna de diodo

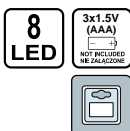

No.	battery / bateria	☐
88670	3xAAA	12/72

PL Diodowa latarka czołowa
 GB Led work lamp
 D Stirntaschenlampe
 RUS Нало́бный светодио́дный фона́рь
 CZ Led montážní lampa - čelovka
 RO Lampa cu led
 H Led fejlámpa
 E Linterna de diodo



No.	battery / bateria	☐
88672	3xAAA	12/60

PL Diodowa latarka czołowa
 GB Led work lamp
 D Stirntaschenlampe
 RUS Нало́бный светодио́дный фона́рь
 CZ Led montážní lampa - čelovka
 RO Lampa cu led
 H Led fejlámpa
 E Linterna de diodo

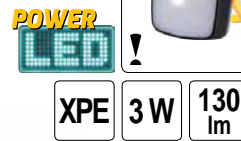

No.	battery / bateria	☐
88677		12/48

PL Diodowa latarka czołowa
 GB Led work lamp
 D Stirntaschenlampe
 RUS Нало́бный светодио́дный фона́рь
 CZ Led montážní lampa - čelovka
 RO Lampa cu led
 H Led fejlámpa
 E Linterna de diodo

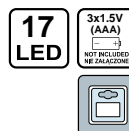

No.	battery / bateria	☐
88671	3xAAA	12/72

PL Diodowa latarka czołowa
 GB Led work lamp
 D Stirntaschenlampe
 RUS Нало́бный светодио́дный фона́рь
 CZ Led montážní lampa - čelovka
 RO Lampa cu led
 H Led fejlámpa
 E Linterna de diodo

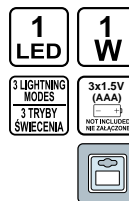

No.	battery / bateria	☐
88673	3xAAA	12/48

PL Diodowa latarka czolowa
 GB Led work lamp
 D Stirntaschenlampe
 RUS Налобный светодиодный фонарь
 CZ Led montážní lampa - čelovka
 RO Lampa cu led
 H Led fejlámpa
 E Linterna de diodo



1 LED 1 W
 3 LIGHTING MODES
 3 TRYBY ŚWIECENIA
 3x1.5V (AAA)
 NOT INCLUDED NE ZAŁĄCZONE



No.	battery / bateria	
88674	3xAAA	12/48

PL Lampa czolowa LED
 GB LED headlamp
 D LED Kopflampe
 RUS Налобный светодиодный фонарь

CZ Čelová lampa LED
 RO Lanterna cu LED pt. cap
 H LED fejlámpa
 E Lámpara LED de Cabeza

3W 150 lm
 3x1.5V (AAA)
 NOT INCLUDED NE ZAŁĄCZONE



No.	battery / bateria	
88676	3xAAA	12/48

PL Zestaw lamp rowerowych LED
 GB LED bike light set
 D Fahrrad-Beleuchtungsset LED
 RUS Набор светодиодных велосипедных фонарей

CZ Set LED osvětlení na kolo
 RO Set lanterna bicicleta LED
 H LED kerékpár lámpa szett
 E Juego de luces LED para bicicleta

5 LED 3W 150 lm
 2x1.5V (AAA)
 NOT INCLUDED NE ZAŁĄCZONE
 3x1.5V (AAA)
 NOT INCLUDED NE ZAŁĄCZONE
 ZOOM

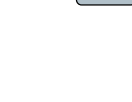

No.	battery / bateria	
88422	3xAAA / 2xAAA	12/48

PL Czujnik ruchu
 GB Motion detector
 D Bewegungsfühler
 RUS Детектор движения

CZ Snímač pohybu
 RO Senzor de mișcare
 H Mozcásérzékelő
 E Sensor del movimiento

220-240V-50/60Hz IP44
 max. 1200 W max. 300 W
 μ



No.		
83120		50

PL Lampa czolowa LED
 GB LED headlamp
 D LED Kopflampe
 RUS Налобный светодиодный фонарь

CZ Čelová lampa LED
 RO Lanterna cu LED pt. cap
 H LED fejlámpa
 E Lámpara LED de Cabeza



1+2 LED 100 lm
 3x1.5V (AAA)
 NOT INCLUDED NE ZAŁĄCZONE



No.	battery / bateria	
88675	3xAAA	12/48

PL Lampa rowerowa przednia LED
 GB LED front bike light
 D Fahrrad Frontscheinwerfer LED
 RUS Светодиодный фонарик для велосипеда

CZ Přední světlá LED na kolo
 RO Lanterna pt. bicicleta LED
 H LED-es első kerékpár lámpa
 E Linterna LED frontal para bicicleta

3W 150 lm
 ZOOM
 3x1.5V (AAA)
 NOT INCLUDED NE ZAŁĄCZONE



No.	battery / bateria	
88411	3xAAA	12/48

PL Zestaw lamp rowerowych LED
 GB LED bike light set
 D Fahrrad-Beleuchtungsset LED
 RUS Набор светодиодных велосипедных фонарей

CZ Set LED osvětlení na kolo
 RO Set lanterna bicicleta LED
 H LED kerékpár lámpa szett
 E Juego de luces LED para bicicleta

POWER LED



No.	battery / bateria	
88421	3xAAA / 2xAAA	12/120

PL Czujnik ruchu
 GB Motion detector
 D Bewegungsfühler
 RUS Детектор движения

CZ Snímač pohybu
 RO Senzor de mișcare
 H Mozcásérzékelő
 E Sensor del movimiento

220-240V-50/60Hz IP44
 max. 1200 W max. 300 W
 μ



No.		
83121		50

PL Czujnik ruchu
GB Motion detector
D Bewegungsfühler
RUS Детектор движения

CZ Snímač pohybu
RO Senzor de mișcare
H Mozgásérzékelő
E Sensor del movimiento

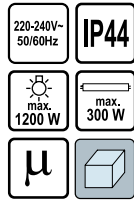

No. 83122  50

PL Czujnik ruchu
GB Motion detector
D Bewegungsfühler
RUS Детектор движения

CZ Snímač pohybu
RO Senzor de mișcare
H Mozgásérzékelő
E Sensor del movimiento

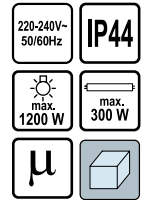
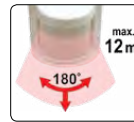

No. 83123  50

PL Czujnik ruchu
GB Motion detector
D Bewegungsfühler
RUS Детектор движения

CZ Snímač pohybu
RO Senzor de mișcare
H Mozgásérzékelő
E Sensor del movimiento

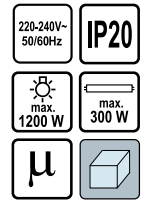

No. 83124  50

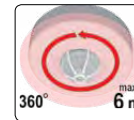

Memo

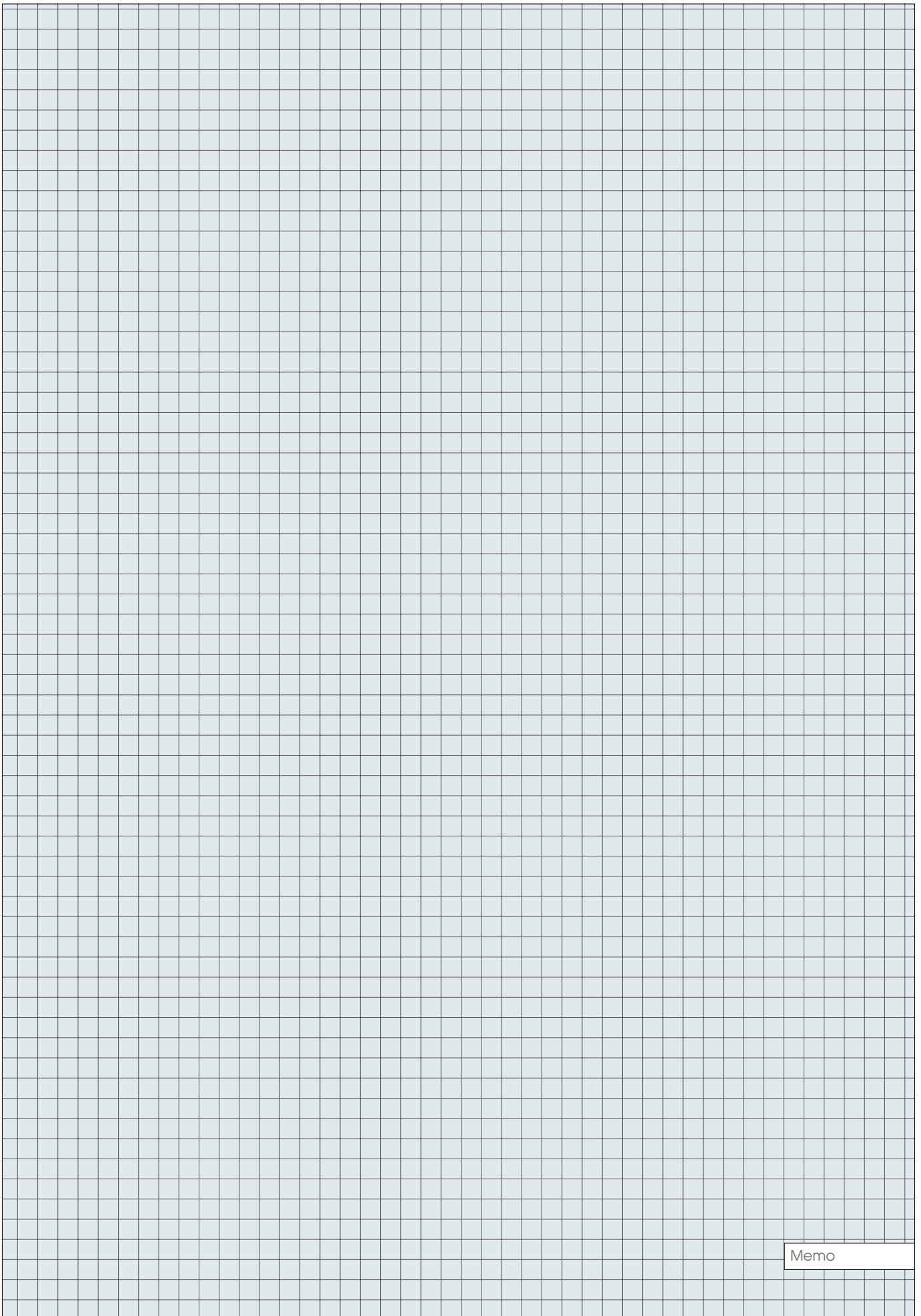

Memo

24

Garden tools & power tools
Narzędzia i elektronarzędzia ogrodowe



Watering program Program wodny

390-403



Hose connectors, male connectors, couplings, hose menders
Złącza, nypły, łączniki, rozgałęźniaki, reparatory..... 390

Water timers
Sterowniki nawadniania..... 393

Hose nozzles (sprinklers) & sets
Zraszacze i zestawy..... 393

Garden hoses
Wężę ogrodowe..... 399

Garden hose carts, holders & guides
Wózki, stojaki i prowadnice do węży..... 400

Pumps
Pompy..... 401

Pruners & shears Sekatory i nożyce ogrodowe

403-408



Pruners
Sekatory..... 403

Lopping shears
Sekatory do gałęzi..... 405

Leverage tree pruners
Sekatory gąsienicowe..... 407

Hedge shears
Nożyce do żywopłotu..... 407

Grass shears
Nożyce do trawy..... 408

Garden saws & blades Piły ogrodowe i brzeszczoty

408-409



Axes & splitting wedges Siekiry i kliny do drewna

409-411



Hand tools Narzędzia ręczne

411-425



Small garden tools
Małe narzędzia ogrodowe..... 411

Big garden tools
Duże narzędzia ogrodowe..... 414

Handles
Trzonki..... 423

Sprayers & accessories Opryskiwacze i akcesoria

426-427



Gasoline garden tools, power tools & accessories Ogrodowe narzędzia spalinowe, elektronarzędzia i akcesoria

428-431



Grass trimmers
Wykasarki..... 428

Hedge trimmers
Nożyce do trawy i żywopłotu..... 428

Accessories
Akcesoria..... 429

Health & safety products Artykuły BHP

431-437



Gloves
Rękawice..... 431

Rain boots
Kalosze..... 433

Multipurpose trays
Podstawki gospodarcze..... 435

Knee pads
Nakolanniki..... 435

Head, hearing & eyesight protection
Ochrona głowy, słuchu i wzroku..... 436

Garden accessories Akcesoria ogrodowe

438-443



BBQ grills & accessories Grille i akcesoria

443-450



Gas BBQ grills
Grille gazowe..... 443

Charcoal BBQ grills
Grille węglowe..... 444

Smokers
Wędzarnie..... 448

Fire pits
Paleniska ogrodowe..... 448

Accessories
Akcesoria..... 449

PL Złącze
GB Hose connector
D Universal
Schnellschlauchkupplung
RUS Соединитель

CZ Rychlospojka
RO Mufă pt. pistol
H Fitting
E Junta estandar

1/2"
12.5mm
3/4"
19mm

ABS



No.	size / rozmiar	packing	
89221	1/2" (12.5 mm)		150/600
89222	1/2" (12.5 mm)		24/288
89223	3/4" (19.0 mm)		60/240
89224	3/4" (19.0 mm)		24/288

PL Złącze
GB Hose connector
D Universal
Schnellschlauchkupplung
RUS Соединитель

CZ Rychlospojka
RO Mufă pt. pistol
H Fitting
E Junta estandar

1/2"
12.5mm
3/4"
19mm

ABS

STOP



No.	size / rozmiar	packing	
89225	1/2" (12.5 mm)		150/600
89226	1/2" (12.5 mm)		24/288
89227	3/4" (19.0 mm)		60/240
89228	3/4" (19.0 mm)		24/288

PL Złącze mosiężne
GB Brass hose connector
D Schlauch-Schnellkupplung
RUS Быстросъемная муфта

CZ Rychlospojka
RO Manșon de îmbinare
H Csallakozó
E Conexión

1/2"
12.5mm
3/4"
19mm
BRASS
MOSIADZ



No.	size / rozmiar	
89100	1/2" (12.5 mm)	48
89102	3/4" (19.0 mm)	48

PL Reparatör do węzła
GB Hose mender
D Schlauchreparator
RUS Соединитель шлангов

CZ Opravka
RO Mufă înădire
H Gyorstoldó
E Reparatör para manguera

1/2"
12.5mm
3/4"
19mm

ABS



No.	size / rozmiar	packing	
89229	1/2" (12.5 mm)		150/600
89230	1/2" (12.5 mm)		24/288
89231	3/4" (19.0 mm)		60/240
89232	3/4" (19.0 mm)		24/288

PL Złącze
GB Hose connector
D Universal
Schnellschlauchkupplung
RUS Соединитель

CZ Rychlospojka
RO Mufă pt. pistol
H Fitting
E Junta estandar

1/2"
12.5mm
3/4"
19mm

ABS



No.	size / rozmiar	
89001	1/2" (12.5 mm)	30/240
89002	3/4" (19.0 mm)	30/240

PL Złącze
GB Hose connector
D Universal
Schnellschlauchkupplung
RUS Соединитель

CZ Rychlospojka
RO Mufă pt. pistol
H Fitting
E Junta estandar

1/2"
12.5mm
3/4"
19mm

ABS STOP



No.	size / rozmiar	
89003	1/2" (12.5 mm)	30/240
89004	3/4" (19.0 mm)	30/240

PL Złącze mosiężne stop
GB Brass hose connector
D Schlauch-Schnellkupplung
RUS Быстросъемная муфта

CZ Rychlospojka
RO Manșon de îmbinare
H Csallakozó
E Conexión

1/2"
12.5mm
3/4"
19mm
BRASS
MOSIADZ

STOP



No.	size / rozmiar	
89101	1/2" (12.5 mm)	48
89103	3/4" (19.0 mm)	48

PL Reparatör do węzła
GB Hose mender
D Schlauchreparator
RUS Соединитель шлангов

CZ Opravka
RO Mufă înădire
H Gyorstoldó
E Reparatör para manguera

1/2"
12.5mm
3/4"
19mm

ABS



No.	size / rozmiar	
89007	1/2" (12.5 mm)	30/240
89008	3/4" (19.0 mm)	30/240

PL Reparatör do węzła
GB Hose mender
D Schlauchreparator
RUS Соединитель шлангов

CZ Opravka
RO Mufă înădire
H Gyorslódó
E Reparatör para manguera



No.	size / rozmiar	packing
89104	1/2" (12.5 mm)	48
89105	3/4" (19.0 mm)	48

PL Reduktor do węzła
GB Hose reducer
D Schlauch Druckminderer
RUS Редуктор

CZ Redukce
RO Reductor
H Szűkítő
E Reductor para manguera

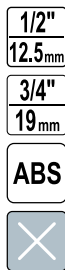

No.	size / rozmiar	packing
89011	1/2"; 3/4" (12.5; 19.0 mm)	30/240

PL Nypel
GB Male connector
D Anschlussgerätestück
RUS Адаптер внутренний

CZ Spojka
RO Mufă pt. robinet cu filet exterior
H Kúlsó menetestőlövég
E Nypel

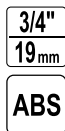

No.	size / rozmiar	packing
89239	3/4" (19.0 mm)	250/1000
89240	3/4" (19.0 mm)	24/288

PL Nypel
GB Male connector
D Anschlussgerätestück
RUS Адаптер внутренний

CZ Spojka
RO Mufă pt. robinet cu filet exterior
H Kúlsó menetestőlövég
E Nypel



No.	size / rozmiar	packing
89110	3/4" (19.0 mm)	48

PL Reduktor do węzła
GB Hose reducer
D Schlauch Druckminderer
RUS Редуктор

CZ Redukce
RO Reductor
H Szűkítő
E Reductor para manguera



No.	size / rozmiar	packing
89233	3/4"; 1/2" (19.0; 12.5 mm)	60/240
89234	3/4"; 1/2" (19.0; 12.5 mm)	24/288

PL Przyłącze do kranu
GB Snap-in tap adaptor
D Wasserhahnanschluss für Gartenschlauch
RUS Адаптер внешний

CZ Šroubení
RO Mufă pt. robinet cu filet interior
H Tömlovég csaphoz
E Tubuladura de grifo



No.	size / rozmiar	packing
89253	1/2" (12.5 mm)	24/240

PL Przyłącze do kranu
GB Snap-in tap adaptor
D Wasserhahnanschluss für Gartenschlauch
RUS Адаптер внешний

CZ Šroubení
RO Mufă pt. robinet cu filet interior
H Tömlovég csaphoz
E Tubuladura de grifo



No.	size / rozmiar	packing
89015	3/4" (19.0 mm)	30/240

PL Przyłącze do kranu
GB Snap-in tap adaptor
D Wasserhahnanschluss für Gartenschlauch
RUS Адаптер для крана

CZ Šroubení
RO Mufă pt. robinet cu filet interior
H Tömlovég csaphoz
E Tubuladura de grifo



No.	size / rozmiar	packing
89235	3/4" (19.0 mm)	250/1000
89236	3/4" (19.0 mm)	24/288

PL Przyłącze do kranu
GB Snap-in tap adaptor
D Wasserhahnanschluss für Gartenschlauch
RUS Адаптер внешний

CZ Šroubení
RO Mufă pt. robinet cu filet interior
H Tömlovég csaphoz
E Tubuladura de grifo



No.	size / rozmiar	
89013	3/4" (19.0 mm)	30/240

PL Przyłącze do kranu
GB Snap-in tap adaptor
D Wasserhahnanschluss für Gartenschlauch
RUS Адаптер для крана
CZ Šroubení
RO Mufă pt. robinet cu filet interior
H Tömlovég csaphoz
E Tubuladura de grifo

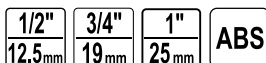

No.	size / rozmiar	packing	
89241	1/2"; 3/4" (12.5; 19.0 mm)		250/1000
89242	1/2"; 3/4" (12.5; 19.0 mm)		24/288
89251	3/4"; 1" (19.0; 25.0 mm)		100/1000
89252	3/4"; 1" (19.0; 25.0 mm)		24/288

PL Przyłącze do kranu
GB Snap-in tap adaptor
D Wasserhahnanschluss für Gartenschlauch
RUS Адаптер для крана

CZ Šroubení
RO Mufă pt. robinet cu filet interior
H Tömlovég csaphoz
E Tubuladura de grifo



No.	size / rozmiar	
89108	1/2"; 3/4" (12.5; 19.0 mm)	48
89109	3/4"; 1" (19.0; 25.0 mm)	48

PL Złącze typu „I”
GB 2 way coupling
D Doppelkupplung
RUS Переходник

CZ Spojka
RO Prelungitor furtun apă
H „I” típusú csötöldő idom
E Junta tipo „I”



No.		
89020		30/240

PL Przyłącze do kranu
GB Snap-in tap adaptor
D Wasserhahnanschluss für Gartenschlauch
RUS Адаптер для крана

CZ Šroubení
RO Mufă pt. robinet cu filet interior
H Tömlovég csaphoz
E Tubuladura de grifo

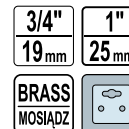

No.	size / rozmiar	
89106	3/4" (19.0 mm)	48
89107	1" (25.0 mm)	48

PL Przyłącze do kranu
GB Snap-in tap adaptor
D Wasserhahnanschluss für Gartenschlauch
RUS Адаптер для крана

CZ Šroubení
RO Mufă pt. robinet cu filet interior
H Tömlovég csaphoz
E Tubuladura de grifo

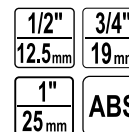

No.	size / rozmiar	
89017	1/2"; 3/4" (12.5; 19.0 mm)	30/240
89018	3/4"; 1" (19.0; 25.0 mm)	30/240

PL Złącze typu „I”
GB 2 way coupling
D Doppelkupplung
RUS Соединитель шлангов

CZ Spojka
RO Prelungitor furtun apă
H „I” típusú csötöldő idom
E Junta tipo „I”

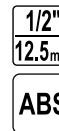

No.	size / rozmiar	packing	
89245	1/2" (12.5 mm)		125/500
89246	1/2" (12.5 mm)		24/288

PL Złącze typu „I”
GB 2 way coupling
D Doppelkupplung
RUS Переходник

CZ Spojka
RO Prelungitor furtun apă
H „I” típusú csötöldő idom
E Junta tipo „I”



No.	size / rozmiar	
89113	1/2" (12.5 mm)	48

PL Rozdzielacz typu „Y”
GB 3 way coupling
D Drei Wege Kupplung
RUS Тройник для шлангов

CZ Y-kus
RO Distributor 3 căi
H „Y” típusú elágazás
E Distribuidor tipo „Y”

ABS



No.	packing	
89243		125/250
89244		24/288

PL Rozdzielacz z zaworami
GB Y-switch coupling with swivel
D 2-Wege Ventil
RUS Распределитель внешний

CZ Rozbočovač s uzavíracími ventily
RO Racord iny cu robinet
H Y-elágazó, 2 db külső menetes elzáróval
E Distribuidor tipo „Y”

3/4"
19mm



No.	size / rozmiar	packing	
89247	3/4" (19.0 mm)		24/240
89248	3/4" (19.0 mm)		12/96

PL Czasowy wyłącznik przepływu wody
GB Water timer
D Bewässerungsuhr
RUS Таймер для управления подачей воды

CZ Zavlažovací hodiny
RO Programator automat
H Vizprogramozó óra
E Programador manual para tubos de agua

3/4"
19mm

1"
25mm

5-120min



No.	size / rozmiar	
89282	3/4"; 1" (19.0; 25.0 mm)	6/24

PL Zraszacz prosty regulowany
GB Adjustable spray nozzle
D Spritze
RUS Распылитель поливочный

CZ Postřikovač
RO Stropitor apă
H Szórófej
E Rociador

ABS



No.	
89200	25/150

PL Rozdzielacz typu „Y”
GB 3 way coupling
D Drei Wege Kupplung
RUS Тройник для шлангов

CZ Y-kus
RO Distributor 3 căi
H „Y” típusú elágazás
E Distribuidor tipo „Y”

1/2"
12.5mm

BRASS
MOSIADZ



No.	size / rozmiar	
89112	1/2" (12.5 mm)	48

PL Rozdzielacz z zaworami
GB Y-switch coupling with swivel
D 2-Wege Ventil
RUS Распределитель внешний

CZ Rozbočovač s uzavíracími ventily
RO Racord iny cu robinet
H Y-elágazó, 2 db külső menetes elzáróval
E Distribuidor tipo „Y”

1/2"
12.5mm

3/4"
19mm

ABS



No.	size / rozmiar	
89022	1/2"; 3/4" (12.5; 19.0 mm)	12/120

PL Zraszacz prosty regulowany
GB Adjustable spray nozzle
D Spritze
RUS Распылитель поливочный

CZ Postřikovač
RO Stropitor apă
H Szórófej
E Rociador

ABS



No.	packing	
89201		25/100
89202		12/120

PL Zraszacz prosty regulowany
GB Adjustable spray nozzle
D Spritze
RUS Распылитель поливочный

CZ Postřikovač
RO Stropitor apă
H Szórófej
E Rociador

ABS



No.	
89187	48

PL Zraszacz prosty CZ Postřikovač
 GB Straight nozzle RO Stropitor apă
 D Spritze H Szórófej
 RUS Распылитель поливочный E Rociador simple



No.	size / rozmiar	
89120	1/2" (12.5 mm)	48

PL Pistolet zraszający regulowany CZ Kropící pistole regulovatelná
 GB Adjustable spray gun RO Pistolet de irigare ajustabil
 D Regelbare Sprühpistole H Öntöző pisztoly, állítható sugarú
 RUS Регулируемый оросительный пистолет E Pistola rociadora ajustable



No.		
89213		12/48

PL Pistolet zraszający regulowany CZ Kropící pistole regulovatelná
 GB Adjustable spray gun RO Pistolet de irigare ajustabil
 D Regelbare Sprühpistole H Öntöző pisztoly, állítható sugarú
 RUS Регулируемый оросительный пистолет E Pistola rociadora ajustable



No.		
89189		12/48

PL Pistolet zraszający regulowany CZ Kropící pistole regulovatelná
 GB Adjustable spray gun RO Pistolet de irigare ajustabil
 D Regelbare Sprühpistole H Öntöző pisztoly, állítható sugarú
 RUS Регулируемый оросительный пистолет E Pistola rociadora ajustable

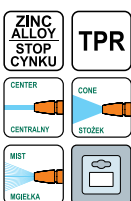

No.		
89196		48

PL Pistolet zraszający regulowany CZ Kropící pistole regulovatelná
 GB Adjustable spray gun RO Pistolet de irigare ajustabil
 D Regelbare Sprühpistole H Öntöző pisztoly, állítható sugarú
 RUS Регулируемый оросительный пистолет E Pistola rociadora ajustable

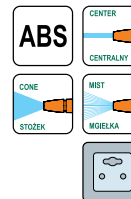

No.		
89210		12/48

PL Pistolet zraszający regulowany CZ Kropící pistole regulovatelná
 GB Adjustable spray gun RO Pistolet de irigare ajustabil
 D Regelbare Sprühpistole H Öntöző pisztoly, állítható sugarú
 RUS Регулируемый оросительный пистолет E Pistola rociadora ajustable

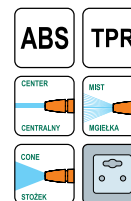

No.		
89214		12/48

PL Pistolet zraszający regulowany CZ Kropící pistole regulovatelná
 GB Adjustable spray gun RO Pistolet de irigare ajustabil
 D Regelbare Sprühpistole H Öntöző pisztoly, állítható sugarú
 RUS Регулируемый оросительный пистолет E Pistola rociadora ajustable



No.		
89193		12/48

PL Pistolet zraszający regulowany CZ Kropící pistole regulovatelná
 GB Adjustable spray gun RO Pistolet de irigare ajustabil
 D Regelbare Sprühpistole H Öntöző pisztoly, állítható sugarú
 RUS Регулируемый оросительный пистолет E Pistola rociadora ajustable

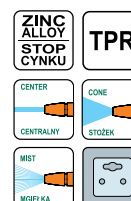

No.		
89190		12/48



- PL Pistolet zraszający regulowany
 GB Adjustable spray gun
 D Regelbare Sprühpistole
 RUS Регулируемый оросительный пистолет
- CZ Kropící pistole regulovatelná
 RO Pistolet de irigare ajustabil
 H Öntöző pisztoly, állítható sugárú
 E Pistola rociadora ajustable

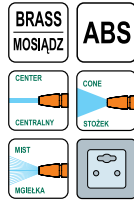

No.	
89215	12/24

- PL Wielofunkcyjny pistolet zraszający
 GB Multifunction sprinkling gun
 D Multifunktions-Spritzpistole
 RUS Многофункциональный оросительный пистолет
- CZ Multifunkční postřikovací pistole
 RO Pistol multifuncțional pt. pulverizare
 H Többfunkciós öntöző pisztoly
 E Pistola para regar multifuncional

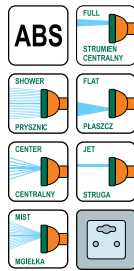

No.	
89220	12/48

- PL Wielofunkcyjny pistolet zraszający
 GB Multifunction sprinkling gun
 D Multifunktions-Spritzpistole
 RUS Многофункциональный оросительный пистолет
- CZ Multifunkční postřikovací pistole
 RO Pistol multifuncțional pt. pulverizare
 H Többfunkciós öntöző pisztoly
 E Pistola para regar multifuncional



No.	
89192	12/48

- PL Wielofunkcyjny pistolet zraszający
 GB Multifunction sprinkling gun
 D Multifunktions-Spritzpistole
 RUS Многофункциональный оросительный пистолет
- CZ Multifunkční postřikovací pistole
 RO Pistol multifuncțional pt. pulverizare
 H Többfunkciós öntöző pisztoly
 E Pistola para regar multifuncional



No.	
89191	12/48

- PL Pistolet zraszający
 GB Sprinkling gun
 D Spritzpistole
 RUS Оросительный пистолет
- CZ Postřikovací pistole
 RO Pistol pt. pulverizare
 H Öntöző pisztoly
 E Pistola para regar

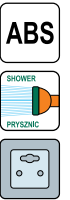

No.	
89209	12/48

- PL Wielofunkcyjny pistolet zraszający
 GB Multifunction sprinkling gun
 D Multifunktions-Spritzpistole
 RUS Многофункциональный оросительный пистолет
- CZ Multifunkční postřikovací pistole
 RO Pistol multifuncțional pt. pulverizare
 H Többfunkciós öntöző pisztoly
 E Pistola para regar multifuncional

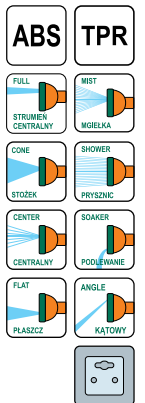

No.	
89211	12/48

- PL Wielofunkcyjny pistolet zraszający
 GB Multifunction sprinkling gun
 D Multifunktions-Spritzpistole
 RUS Многофункциональный оросительный пистолет
- CZ Multifunkční postřikovací pistole
 RO Pistol multifuncțional pt. pulverizare
 H Többfunkciós öntöző pisztoly
 E Pistola para regar multifuncional

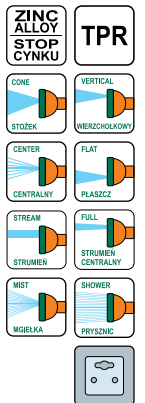

No.	
89195	6/24

- PL Zestaw złączek ze zraszaczem prostym
 GB Basic hose set with straight nozzle
 D Bewässerungs Spritz und Anschlusset
 RUS Набор поливочный
- CZ Postřikovač + spojky
 RO Ștut furtun apă cu accesorii pt. robinet
 H Készlet gyorskapocsos csaphoz
 E Juego de rociar tubuladura de grifo



No.	size / rozmiar	pcs	
89203	3/4"; 1" (19.0; 25.0 mm)	4	12/72
89204	1/2"; 3/4" (12.5; 19.0 mm)	4	12/72

- PL Zestaw złączek ze zraszaczem prostym
 GB Basic hose set with straight nozzle
 D Bewässerungs Spritz und Anschlussset
 RUS Набор поливочный
- CZ Postřikovač + spojky
 RO Ștut furtun apă cu accesorii pt. robinet
 H Készlet gyorskapoccsal csaphoz
 E Juego de rociar tubuladura de grifo



4
PCS

1/2"
12.5mm

3/4"
19mm

1"
25mm

ABS



No.	size / rozmiar	pcs
89255	3/4"; 1" (19.0; 25.0 mm)	12/48

- PL Zestaw złączek ze zraszaczem pistoletowym
 GB Basic hose set with adjustable spray gun
 D Spritzbrause und Anschlussset
 RUS Набор поливочный
- CZ Rozprašovaci pistole na vodu + spojky
 RO Pistol reglabil cu și accesorii
 H Résztes készlet – os tömlőhöz
 E Juego de rociar para manguera



4
PCS

ABS

FULL STRUMIEN CENTRALNY

CENTER CENTRALNY

JET STRUGA

MIST MGIELKA

SHOWER PRYSZNIC

FLAT PLASZCZ

EVA



No.	size / rozmiar	pcs
89207	1/2"; 3/4" (12.5; 19.0 mm)	4 12/48

- PL Wąż spiralny z pistoletem zraszającym
 GB Coil hose set with spray gun
 D Spiralschlauch mit Multifunktionsbrause
 RUS Спиральный шланг в наборе с пистолетом
- CZ Pištoľ striekacia s vinutou hadicou
 RO Furtun în spirală cu pistol pt. stropiți
 H Locsoló pisztoly tömlővel
 E Manguera espiral con rociador



15m

COIL HOSE SPIRALNY WĄZ

EVA

JET STRUGA

SHOWER PRYSZNIC

CENTER CENTRALNY

FLAT PLASZCZ

SOAKER PODLEWANE

MIST MGIELKA

CONE STÓZEK



No.	L (m)	pcs
89351	15	8

- PL Lanca zraszająca wielofunkcyjna
 GB Sprinkling lance
 D Multifunktions-Spritzstab
 RUS Пика для распылителя многофункциональная
- CZ Multifunkční postřikovač nadstavec
 RO Tijă pt. irigare
 H Többfunkciós esőztető fej
 E Lanza para regar multifuncional

AI

ABS

FULL STRUMIEN CENTRALNY

VERTICAL WERZCHOKOWY

CONE STÓZEK

SOAKER PODLEWANE

FLAT PLASZCZ

CENTER CENTRALNY

ANGLE KĄTOWY

CIRCLE OKRĄGLY

SHOWER PRYSZNIC

MIST MGIELKA



No.	pcs
89218	12

- PL Zestaw złączek ze zraszaczem pistoletowym
 GB Basic hose set with adjustable spray gun
 D Spritzbrause und Anschlussset
 RUS Набор поливочный
- CZ Rozprašovaci pistole na vodu + spojky
 RO Pistol reglabil cu și accesorii
 H Résztes készlet – os tömlőhöz
 E Juego de rociar para manguera



4
PCS

ABS

CENTER CENTRALNY

FULL STRUMIEN CENTRALNY

FLAT PLASZCZ

JET STRUGA

SHOWER PRYSZNIC

MIST MGIELKA

EVA



No.	size / rozmiar	pcs
89206	1/2" (12.5 mm)	4 12/48

- PL Zestaw złączek ze zraszaczem pistoletowym
 GB Basic hose set with adjustable spray gun
 D Spritzbrause und Anschlussset
 RUS Набор поливочный
- CZ Rozprašovaci pistole na vodu + spojky
 RO Pistol reglabil cu și accesorii
 H Résztes készlet – os tömlőhöz
 E Juego de rociar para manguera



4
PCS

ABS

SHOWER PRYSZNIC

CIRCLE OKRĄGLY

CENTER CENTRALNY

SOAKER PODLEWANE

MIST MGIELKA

FLAT PLASZCZ

VERTICAL WERZCHOKOWY

ANGLE KĄTOWY

CONE STÓZEK

FULL STRUMIEN CENTRALNY

EVA



No.	size / rozmiar	pcs
89208	1/2" (12.5 mm)	4 12/48

- PL Pysznica ogrodowy
 GB Garden shower
 D Gartendusche
 RUS Распылитель садовый
- CZ Zahradní sprcha
 RO Duș pt. grădină
 H Kerít zuhany
 E Regadera para jardín



165cm

240cm

SHOWER PRYSZNIC



No.	pcs
89390	6

- PL Zestaw uszczelek CZ Sada těsnění
 GB Set of gaskets RO Set de garnituri
 D Dichtungssatz H Tömítéskészlet esőztetőhöz
 RUS Набор прокладок E Juego de juntas



No.	pcs	for / dla	
89270	14	89100-89267	20/80

- PL Zraszacz 3-ramienny
 GB 3-arms revolving sprinkler
 D 3-Arm Kreis-Regner
 RUS Трехсторонний вращающийся распылитель на пике
 CZ Rozprašovač tříramenný
 RO Aspersol cu 3 brate
 H Locsoló, leszűrhető, forgó
 E Rociador 3-brazos



No.	
89262	12/48

- PL Zraszacz impulsowy
 GB Impulse sprinkler
 D Impulsregner
 RUS Распылитель импульсный на пике
 CZ Postřikovač
 RO Stropitor apă
 H Impulzus szórófej
 E Rociador

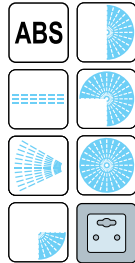

No.	
89261	12/48

- PL Zraszacz impulsowy
 GB Impulse sprinkler
 D Impulsregner
 RUS Распылитель импульсный на пике
 CZ Postřikovač
 RO Stropitor apă
 H Impulzus szórófej
 E Rociador

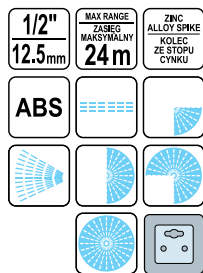

No.	
89259	48

- PL Zraszacz 3-ramienny
 GB 3-arms revolving sprinkler
 D 3-Arm Kreis-Regner
 RUS Трехсторонний вращающийся распылитель на пике
 CZ Rozprašovač tříramenný
 RO Aspersol cu 3 brate
 H Locsoló, leszűrhető, forgó
 E Rociador 3-brazos



No.	
89272	12/48

- PL Zraszacz 3-ramienny
 GB 3-arm revolving sprinkler with spike
 D 3-Arm Kreis-Regner
 RUS Трехсторонний вращающийся распылитель на пике
 CZ Rozprašovač tříramenný
 RO Aspersol cu 3 brate
 H Locsoló, leszűrhető, forgó
 E Rociador 3-brazos



No.	
89263	12/48

- PL Zraszacz impulsowy
 GB Impulse sprinkler
 D Impulsregner
 RUS Распылитель импульсный на пике
 CZ Postřikovač
 RO Stropitor apă
 H Impulzus szórófej
 E Rociador

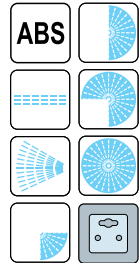

No.	
89260	12/48

- PL Zraszacz impulsowy
 GB Impulse sprinkler
 D Impulsregner
 RUS Распылитель импульсный на пике
 CZ Postřikovač
 RO Stropitor apă
 H Impulzus szórófej
 E Rociador

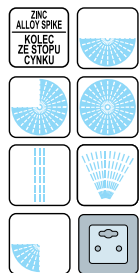

No.	
89260	12/48

PL Zraszacz 3-ramienny naziemny
GB 3-arms revolving sprinkler on base
D 3-Arm Kreis-Regner
RUS Трёхсторонний вращающийся
распылитель на подставке

CZ Rozprašovateľ triramenný
RO Aspersol cu 3 brate
H Locsoló, leszűrhető, forgó
E Rociador 3-brazos



FLO

No.
89267

24

PL Zraszacz 8-funkcyjny
GB 8 pattern sprinkler
D 8-Flächenregner
RUS Распылитель 8-позиционный на подставке
CZ Postřikovač
RO Stropitor apă cu 8 duze
H 8 funkciós szórófej
E Rociador 8-funciones de tierra



FLO

No.
89273

6/36

PL Zraszacz impulsowy
GB Impulse sprinkler
D Impulsregner
RUS Распылитель импульсный на пике
CZ Postřikovač
RO Stropitor apă
H Impulzus szórófej
E Rociador

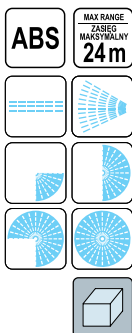

FLO

No.
89275

48

PL Zraszacz oscylacyjny
GB Oscillating sprinkler
D Rechteckregner
RUS Дождеватель осциллирующий
CZ Obdélníkový zavlažovač
RO Aspersor oscilant
H Esőztető, négyyszög alakú
E Aspersor oscilante

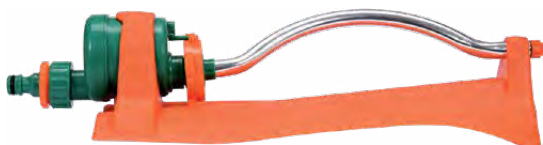
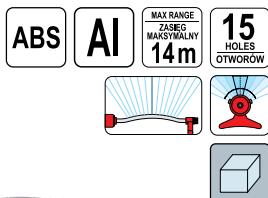

FLO

No.
89277

12

PL Zraszacz 8-funkcyjny
GB 8 pattern sprinkler
D 8-Flächenregner
RUS Распылитель 8-позиционный на подставке
CZ Postřikovač
RO Stropitor apă cu 8 duze
H 8 funkciós szórófej
E Rociador 8-funciones de tierra

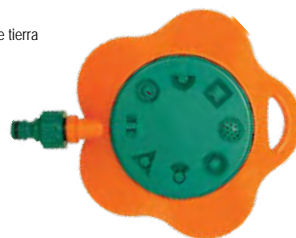
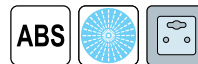

FLO

No.
89265

24/48

PL Zraszacz 3-funkcyjny
GB 3 pattern sprinkler
D 3-Flächenregner
RUS Распылитель 3-позиционный на подставке
CZ Postřikovač
RO Stropitor apă cu 3 duze
H 3 funkciós szórófej
E Rociador 3-funciones de tierra

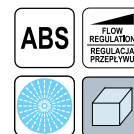

FLO

No.
89274

48

PL Zraszacz impulsowy
GB Impulse sprinkler
D Impulsregner
RUS Распылитель импульсный на пике
CZ Postřikovač
RO Stropitor apă
H Impulzus szórófej
E Rociador

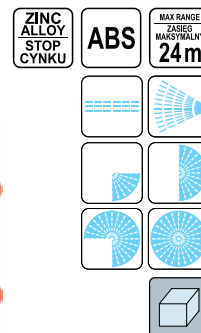

FLO

No.
89271

48

PL Zraszacz wynurzalny
GB Impulse pop-up sprinkler
D Tauchimpulssprinkler
RUS Дождеватель выдвижной

CZ Zavlažovač výsuvný
RO Aspersor cu impuls
H Esőztető szórófej
E Rociador de emerjer



FLO

No.
89280

12

PL Wąż ogrodniczy CZ Zahradní hadice
 GB Garden hose RO Furtun de gradina
 D Gartenschlauch H Kerti tömlő
 RUS Садовый шланг E Manguera de jardín

8 bar

15 bar BURSTING PRESSURE CÍSNIEŃIE ROZRYWAJĄCE

TEMPERATURE TOLERANCE ODPOORNOSC NA TEMPERATURĘ **-5°C ÷ +50°C**

UV PROOF ODPOORNOSC NA PROMIENIOWANIE UV



No.	L (m)	Ø	
89302	20	1/2" (12.5 mm)	1
89303	30	1/2" (12.5 mm)	1
89305	50	1/2" (12.5 mm)	1
89307	20	3/4" (19.0 mm)	1
89308	30	3/4" (19.0 mm)	1
89310	50	3/4" (19.0 mm)	1
89298	20	1" (25.0 mm)	1
89299	30	1" (25.0 mm)	1
89300	50	1" (25.0 mm)	1

PL Wąż ogrodniczy CZ Zahradní hadice
 GB Garden hose RO Furtun de gradina
 D Gartenschlauch H Kerti tömlő
 RUS Садовый шланг E Manguera de jardín

10 bar

30 bar BURSTING PRESSURE CÍSNIEŃIE ROZRYWAJĄCE

TEMPERATURE TOLERANCE ODPOORNOSC NA TEMPERATURĘ **-10°C ÷ +60°C**

UV PROOF ODPOORNOSC NA PROMIENIOWANIE UV

BIOFILM RESISTANT ODPOORNOSC NA GLONY



No.	L (m)	Ø	
89290	20	1/2" (12.5 mm)	1
89291	30	1/2" (12.5 mm)	1
89292	50	1/2" (12.5 mm)	1
89293	20	3/4" (19.0 mm)	1
89294	30	3/4" (19.0 mm)	1
89295	50	3/4" (19.0 mm)	1

PL Wąż kroplujący CZ Kapací hadice
 GB Drip hose RO Picurare furtun
 D Tropfschlauch H Locsolótömlő
 RUS Капельный шланг E Manguera de goteo



No.	L (m)	
89370	7.5	32
89371	15.0	15
89372	22.5	12
89373	30.0	8

PL Wąż ogrodniczy CZ Zahradní hadice
 GB Garden hose RO Furtun de gradina
 D Gartenschlauch H Kerti tömlő
 RUS Садовый шланг E Manguera de jardín

ALGAE SETTLING PROOF ODPOORNOSC NA OSADZANIE SIĘ GLONÓW

25 bar BURSTING PRESSURE CÍSNIEŃIE ROZRYWAJĄCE

UV PROOF ODPOORNOSC NA PROMIENIOWANIE UV

TEMPERATURE TOLERANCE ODPOORNOSC NA TEMPERATURĘ **-5°C ÷ +50°C**



8 bar





No.	L (m)	Ø	
89311	20	1/2" (12.5 mm)	1
89312	30	1/2" (12.5 mm)	1
89313	50	1/2" (12.5 mm)	1
89314	20	3/4" (19.0 mm)	1
89315	30	3/4" (19.0 mm)	1
89316	50	3/4" (19.0 mm)	1
89318	20	1" (25.0 mm)	1
89319	30	1" (25.0 mm)	1
89320	50	1" (25.0 mm)	1

PL Wąż zraszający CZ Hadicový zavlažovač
 GB Soaker hose RO Furtun de aspersoare
 D Einweichen Schlauch H Esőztetőtömlő
 RUS Спринклерный шланг E Manguera de remojo

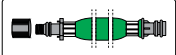

PVC

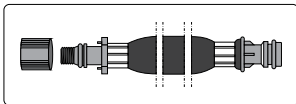
No.	L (m)	
89360	7.5	32
89361	15.0	15



PVC POLYESTER POLIESTER





- PL Wąż odpływowy do pomp
GB Pump drain hose
D Abflussschlauch für die Pumpen
RUS Сливной шланг для насосов
- CZ Výtlačná hadice pro čerpadla
RO Furtun de evacuare pt. pompe
H Elifolyó tömlő szivattyúhoz
E Manguera de salida para bombas

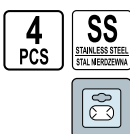

No.	L (m)	Ø	wall thickness / grubość ścianki	
79960	10	1" (25 mm)	1.2	15
79962	20	1" (25 mm)	1.2	8
79963	30	1" (25 mm)	1.2	6
79965	50	1" (25 mm)	1.2	3
79968	20	5/4" (32 mm)	1.4	6
79971	50	5/4" (32 mm)	1.4	3
79973	20	3/2" (38 mm)	1.8	4

- PL Opaska ślimakowa do węża
GB Hose clip
D Schlauchklemme
RUS Хомут стальной
- CZ Šneková páska
RO Colier metallic
H Csígapánt
E Abrazadora



No.	Ø (mm)	for hose / do węża Ø	pcs.	
73506	12-20	1/2" (12.5 mm)	4	20
73507	16-25	3/4" (19.0 mm)	4	10/20
73508	20-32	1" (25.0 mm)	4	20
73510	12-20	1/2" (12.5 mm)	4	20
	16-25	3/4" (19.0 mm)	4	20
73511	16-25	3/4" (19.0 mm)	4	20
	20-32	1" (25.0 mm)	4	20

- PL Wózek do węża ogrodowego
GB Hose cart
D Gartenschlauchwagen
RUS Барабан для намотки поливочного шланга
CZ Stojan navijeci na zahradní hadici
RO Suport pt. furtun
H Utartódob locsolótömlőhöz
E Carretilla para manguera de jardín

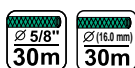

89335

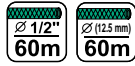
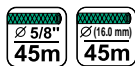

89336



No.	size / rozmiar	
89335	5/8" (16.0 mm) / 30m; 1/2" (12.5 mm) / 45m	5
89336	5/8" (16.0 mm) / 45m; 1/2" (12.5 mm) / 60m	5



- PL Stojak do węża ogrodowego
GB Hose holder
D Gartenschlauchträger
RUS Барабан для намотки поливочного шланга
CZ Stojan navijeci na zahradní hadici
RO Suport pt. furtun
H Utartódob locsolótömlőhöz
E Estante para manguera de jardín

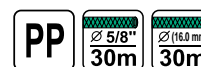

89330



89331



No.	size / rozmiar	
89330	5/8" (16.0 mm) / 30m; 1/2" (12.5 mm) / 45m	5
89331	5/8" (16.0 mm) / 45m; 1/2" (12.5 mm) / 60m	5

- PL Zestaw do podlewania
GB Watering set
D Bewässerung Satz
RUS Набор для полива
CZ Zalévání kit
RO Kit de udare
H Locsoló készlet
E Set de riego con manguera



No.	L (m)	
89342	10	8

- PL Wieszak na wąż ogrodowy
GB Hose hanger
D Gartenschlauchträger
RUS Кронштейн настенный для шланга
- CZ Věšák na hadici zahradní
RO Suport de perete pt. furtun
H Kertiömlő-akasztó
E Colgador para manguera de jardín



No.	
89345	60

- PL Pompa ręczna
GB Hand pump
D Schwingelpumpe
RUS Насос ручной
- CZ Pumpa ruční
RO Pompa manuala
H Kézi szivattyú
E Bomba de mano



No.	
89552	1

- PL Pompa zatapialna do wody brudnej
GB Dirty water submersible pump
D Tauchmotorpumpe
RUS Погружной насос
CZ Zatavovací čerpadlo
RO Pompă pt. apă murdară
H Búvárszivattyú
E Bomba de inmersión para agua sucia

230V~ 50Hz	400 W	Q max 6000 l/h	Δ H max 6 m
1" 25 mm	5/4" 32 mm	1.5" 38 mm	



No.	W	l/h	H (max)	
79909	400	6000	6	6

- PL Prowadnica węża
GB Hose guide
D Schlauchekführung
RUS Направляющее приспособление для шланга
- CZ Vodítko s rolnami na hadici
RO Ghidaj pt. furtuh
H Tomló vezető
E Guíddera para manguera

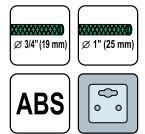

No.	
89348	6/24

- PL Podstawa pod pompę
GB Pump base
D Pumpenständer
RUS Подставка для насоса
CZ Podstavec pumpy
RO Suport pt. pompa
H Szivattyútalp
E Soporte para bomba



No.	for / dla	
89553	89552	1

- PL Pompa zatapialna do wody brudnej
GB Dirty water submersible pump
D Tauchmotorpumpe
RUS Погружной насос
CZ Zatavovací čerpadlo
RO Pompă pt. apă murdară
H Búvárszivattyú
E Bomba de inmersión para agua sucia

230V~ 50Hz	1" 25 mm	5/4" 32 mm	1.5" 38 mm	
---------------	-------------	---------------	---------------	--



No.	W	l/h	H (max)	
79781	400	8000	5.5	4
79782	500	10000	6.5	4
79783	600	11500	7.0	4

- PL Pompa zatapialna do wody brudnej
- GB Dirty water submersible pump
- D Tauchmotorpumpe
- RUS Погружной насос
- CZ Zátavovací čerpadlo
- RO Pompă pt. apă murdară
- H Búvárszivattyú
- E Bomba de inmersión para agua sucia

230V~ 50Hz	1" 25mm
5/4" 32mm	1.5" 38mm





No.	W	l / h	H (max)	
79771	400	10000	6.5	4
79772	550	11500	7.0	4
79773	750	14000	7.5	4
79774	900	16000	8.5	4
79775	1100	16000	8.5	4

- PL Pompa membranowa zatapialna
- GB Membrane deep well water pump
- D Tauchmotorpumpe
- RUS Погружной насос
- CZ Zátavovací čerpadlo
- RO Pompă pt. apă cu membrană
- H Búvárszivattyú
- E Bomba de diafragma sumergible

220-230V~ 50Hz	Q max 1020 l/h
280 W	Δ H max 68 m





No.	W	l / h	H max (m)	
79943	280	1020	68	4

- PL Pompa zatapialna do wody brudnej i ścieków
- GB Submersible pump for dirty water and wastewater
- D Tauchpumpe für Schmutzwasser
- RUS Погружной насос для грязной воды
- CZ Ponorné čerpadlo pro odpadní vody
- RO Pompă submersibilă pt. apă uzată
- H Búvárszivattyú szennyvíz
- E Bomba sumergible para aguas residuales

230V~ 50Hz	450 W
---------------	-------





No.	W	l / h	H (max)	
79880	450	16000	9	1

- PL Pompa zatapialna do wody brudnej
- GB Dirty water submersible pump
- D Tauchmotorpumpe
- RUS Погружной насос
- CZ Zátavovací čerpadlo
- RO Pompă pt. apă murdară
- H Búvárszivattyú
- E Bomba de inmersión para agua sucia

230V~ 50Hz	1" 25mm
5/4" 32mm	1.5" 38mm





No.	W	l / h	H (max)	
79790	750	14000	7.5	2
79791	900	16000	8.5	2
79792	1100	20000	9.0	2

- PL Pompa membranowa zatapialna
- GB Membrane deep well water pump
- D Tauchmotorpumpe
- RUS Погружной насос
- CZ Zátavovací čerpadlo
- RO Pompă pt. apă cu membrană
- H Búvárszivattyú
- E Bomba de diafragma sumergible

220-230V~ 50Hz	350 W
Q max 1200 l/h	Δ H max 70 m





No.	W	l / h	H max (m)	
79944	350	1200	70	4

- PL Pompa ogrodowa
- GB Jet pump
- D Gartenpumpe
- RUS Насос садовый
- CZ Zahradní čerpadlo
- RO Pompă apa
- H Kerti szivattyúhoz
- E Bomba de jardín con cabeza

230V~ 50Hz	
---------------	---



L_{WA} = 95 ± 3 dB

No.	W	l / h	H (max)	max. pressure / max. ciśnienie (bar)	
79810	600	2800	35	3.5	1
79811	800	3600	40	4.0	1
79812	1000	3800	44	4.4	1



PL Pompa fontannowa
GB Fountain pump
D Springbrunnenpumpe
RUS Фонтанный насос
CZ Fontánová pumpa
RO Pompa pt. fantana arteziana
H Pumpa szökőkúthoz
E Bomba para las fuentes

230V~
50Hz

3
NOZZLES
DYSZE

IPX8



No.	W	l / h	H (max)	
79926	8	600	1.0	12
79927	16	800	1.3	12
79928	22	1000	1.6	12

PL Pompa fontannowa
GB Fountain pump
D Springbrunnenpumpe
RUS Фонтанный насос
CZ Fontánová pumpa
RO Pompa pt. fantana arteziana
H Pumpa szökőkúthoz
E Bomba para las fuentes

230V~
50Hz

5
NOZZLES
DYSZE

IPX8



No.	W	l / h	H (max)	
79929	28	1400	2.0	8
79930	40	1800	2.5	8

PL Pompa fontannowa
GB Fountain pump
D Springbrunnenpumpe
RUS Фонтанный насос
CZ Fontánová pumpa
RO Pompa pt. fantana arteziana
H Pumpa szökőkúthoz
E Bomba para las fuentes

230V~
50Hz

CABLE
10m

IP68

5
NOZZLES



No.	W	l / h	H (max)	
79931	55	2000	2.5	8
79932	85	3000	3.5	8
79933	100	4500	4.5	6

PL Sekator uniwersalny
GB By-pass pruner
D Rebenschere
RUS Секатор

CZ Nožnice zahradnícke
RO Foarfece pt. pomi
H Metszoolló
E Podadera universal

180
mm



No.	L (mm)	
99193	180	12/120

PL Sekator uniwersalny
GB By-pass pruner
D Rebenschere
RUS Секатор

CZ Nožnice zahradnícke
RO Foarfece pt. pomi
H Metszoolló
E Podadera universal

200
mm



No.	L (mm)	
99230	200	20/60

PL Sekator uniwersalny
GB By-pass pruner
D Rebenschere
RUS Секатор

CZ Nožnice zahradnícke
RO Foarfece pt. pomi
H Metszoolló
E Podadera universal

190
mm



No.	L (mm)	
99194	190	12/120

PL Sekator uniwersalny
GB By-pass pruner
D Rebenschere
RUS Секатор

CZ Nožnice zahradnícke
RO Foarfece pt. pomi
H Metszoolló
E Podadera universal

200
mm

65
Mn

20mm

PTFE
COATED
POWERKARE



No.	L (mm)	
99190	200	18/72

PL Sekator uniwersalny CZ Nożnice ogrodnicze
 GB By-pass pruner RO Foarfece pt. pomi
 D Rebenschere H Metszoolló
 RUS Секатор E Podadera universal



No.	L (mm)	
99209	215	6/48

PL Sekator uniwersalny CZ Nożnice ogrodnicze
 GB By-pass pruner RO Foarfece pt. pomi
 D Rebenschere H Metszoolló
 RUS Секатор E Podadera universal

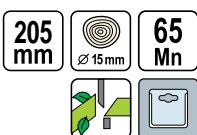

No.	L (mm)	
99203	205	20/60

PL Sekator uniwersalny CZ Nożnice ogrodnicze
 GB By-pass pruner RO Foarfece pt. pomi
 D Rebenschere H Metszoolló
 RUS Секатор E Podadera universal

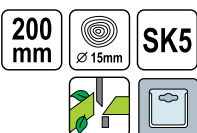

No.	L (mm)	
99208	200	12/60

PL Sekator kowadełkowy CZ Nożnice ogrodnicze
 GB Professional anvil pruner RO Foarfece pt. pomi
 D Amboss-Gartenschere H Metszoolló
 RUS Секатор E Podadera de bigornia

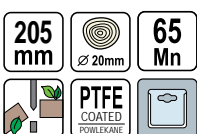

No.	L (mm)	
99207	205	20/60

PL Sekator uniwersalny CZ Nożnice ogrodnicze
 GB By-pass pruner RO Foarfece pt. pomi
 D Rebenschere H Metszoolló
 RUS Секатор E Podadera universal



No.	L (mm)	
99202	180	18/72

PL Sekator uniwersalny CZ Nożnice ogrodnicze
 GB By-pass pruner RO Foarfece pt. pomi
 D Rebenschere H Metszoolló
 RUS Секатор E Podadera universal

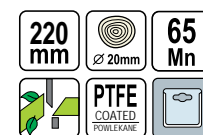

No.	L (mm)	
99204	220	20/60

PL Sekator uniwersalny CZ Nożnice ogrodnicze
 GB By-pass pruner RO Foarfece pt. pomi
 D Rebenschere H Metszoolló
 RUS Секатор E Podadera universal



No.	L (mm)	
99206	210	20/60

PL Sekator kowadełkowy CZ Nożnice ogrodnicze
 GB Professional anvil pruner RO Foarfece pt. pomi
 D Amboss-Gartenschere H Metszoolló
 RUS Секатор E Podadera de bigornia

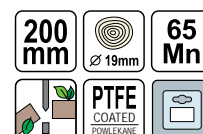

No.	L (mm)	
99191	200	18/72

PL Sekator wielofunkcyjny CZ Nożnice zahradnicke
 GB Garden pocket pruner RO Foarfece pt. pomi
 D Rebschere H Metszoolló
 RUS Секатор E Tijeras de podar



No.	L (mm)	
99210	200	12/48

PL Zestaw sekatorów CZ Zahradnicke nůžky sada
 GB By-pass pruners set RO Set de foarfece pt. pomi
 D Scherenset H Metszsoolló készlet
 RUS Набор ножниц E Juego de tijeras



No.	L (mm)	
99195	150	24

PL Nożyce florystyczne CZ Květinové nůžky
 GB Flower shears RO Foarfece de grădină
 D Blumenschere H Virág ollók
 RUS Цветочные ножницы E Tijeras de podar



No.	L (mm)	
99181	145	12/120

PL Sekator do gałęzi CZ Nožnice zahradnicke
 GB By-pass lopping shears RO Foarfece curbata pt. taiat crengi
 D Astschere H Ágvágó fix
 RUS Сучкорез E Podadera para ramas

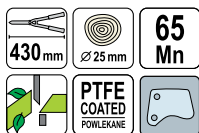

No.	L (mm)	
99101	430	12

PL Sekator do obcinania zawiązków CZ Nożnice zahradnicke
 GB Fruit and flowers shears RO Foarfece pt. pomi
 D Blumen- und Rebschere H Metszoolló
 RUS Секатор E Podadera para cortar germenos



No.	L (mm)	
99240	190	12/72

PL Nożyce florystyczne CZ Květinové nůžky
 GB Flower shears RO Foarfece de grădină
 D Blumenschere H Virág ollók
 RUS Цветочные ножницы E Tijeras de podar



No.	L (mm)	
99180	170	12/120

PL Nożyce florystyczne CZ Květinové nůžky
 GB Flower shears RO Foarfece de grădină
 D Blumenschere H Virág ollók
 RUS Цветочные ножницы E Tijeras de podar



No.	L (mm)	
99182	165	12/120

PL Sekator do gałęzi CZ Nožnice zahradnicke
 GB By-pass lopping shears RO Foarfece curbata pt. taiat crengi
 D Astschere H Ágvágó fix
 RUS Сучкорез E Podadera para ramas

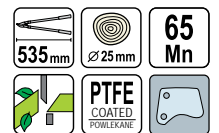

No.	L (mm)	
99103	535	12

PL Sekator do gałęzi
GB By-pass lopping shears
D Astschere
RUS Сучкорез

CZ Nožnice zahradnicke
RO Foarfeca curbata pt. taiat crengii
H Ágvágó fix
E Podadera para ramas

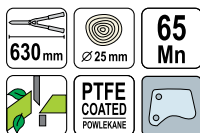

FLO

No.	L (mm)	
99104	630	12

PL Sekator do gałęzi
GB By-pass lopping shears
D Astschere
RUS Сучкорез
CZ Nožnice zahradnicke
RO Foarfeca curbata pt. taiat crengii
H Ágvágó fix
E Podadera para ramas



FLO

No.	L (mm)	
99116	690	12

PL Teleskopowy sekator do konarów
GB Telescopic by-pass lopping shear
D Ast schere
RUS Секатор с телескопическими ручками
CZ Nožnice zahradnicke na hrubé konáre
RO Foarfeca taiat crengii
H Ágvágó teleszkópos
E Podadera para ramas telescopico

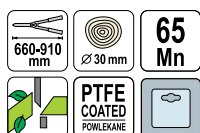

FLO

No.	L (mm)	
99119	660-910	12

PL Teleskopowy sekator do konarów
GB Telescopic by-pass lopping shear
D Ast schere
RUS Секатор с телескопическими ручками
CZ Nožnice zahradnicke na hrubé konáre
H Ágvágó teleszkópos
E Podadera para ramas telescopico



FLO

No.	L (mm)	
99113	690-1030	6

PL Sekator do gałęzi
GB By-pass lopping shears
D Astschere
RUS Сучкорез

CZ Nožnice zahradnicke
RO Foarfeca curbata pt. taiat crengii
H Ágvágó fix
E Podadera para ramas

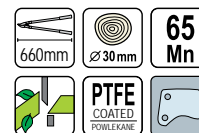

FLO

No.	L (mm)	
99109	660	12

PL Sekator do gałęzi
GB By-pass lopping shears
D Astschere
RUS Сучкорез
CZ Nožnice zahradnicke
RO Foarfeca curbata pt. taiat crengii
H Ágvágó fix
E Podadera para ramas



FLO

No.	L (mm)	
99111	700	12

PL Teleskopowy sekator do konarów
GB Telescopic by-pass lopping shears
D Ast Schere
RUS Секатор с телескопическими ручками
CZ Nožnice zahradnicke na hrubé konáre
RO Foarfeca taiat crengii
H Ágvágó teleszkópos
E Podadera para ramas telescopico



FLO

No.	L (mm)	
99114	660-1000	12

PL Sekator do gałęzi
GB Anvil lopping shears
D Astschere
RUS Сучкорез с храповым механизмом
CZ Nožnice zahradnicke na hrubé konáre
RO Foarfeca curbata pt. taiat crengii
H Ágvágó fix
E Podadera para ramas con carraca

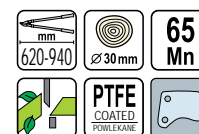

FLO

No.	L (mm)	
99115	620-940	12

PL Sekator do gałęzi
GB Anvil lopping shears
D Astschere
RUS Сучкорез с храповым механизмом
CZ Nožnice zahradnicke na hrubé konáre
RO Foarfeca curbata pt. taiat crengi
H Ágvágó fix
E Podadera para ramas con carraca

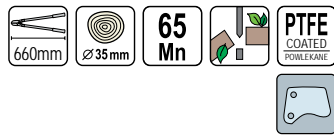

FLO

No.	L (mm)	
99110	660	12

PL Sekator gašienicowy z piłą
GB Leverage tree pruner
D Baumsäge mit Astschere
RUS Сучкорез штанговый с пилой

CZ Stříhač na větve s pilovým listem
RO Fierastrau pt. pomi cu prelungitor
H Kóteles ágvágó
E Podadera de palanca con sierra



FLO

No.	L (mm)	
99310	330	12/24

PL Nożyce do żywoplotu
GB Hedge shears
D Heckenschere
RUS Кусторезы
CZ Nožnice na živý plot
RO Foarfeca pt. gard viu
H Sövényvágó olló
E Tijeras para seto vivo



FLO

No.	L (mm)	
99001	415	12

PL Nożyce do żywoplotu
GB Hedge shears
D Heckenschere
RUS Кусторезы
CZ Nožnice na živý plot
RO Foarfeca pt. gard viu
H Sövényvágó olló
E Tijeras para seto vivo



FLO

No.	L (mm)	
99006	630	12

PL Sekator do gałęzi
GB Anvil lopping shears
D Astschere
RUS Сучкорез с храповым механизмом
CZ Nožnice zahradnicke na hrubé konáre
RO Foarfeca curbata pt. taiat crengi
H Ágvágó fix
E Podadera para ramas con carraca



FLO

No.	L (mm)	
99112	690	12

PL Przedłużka teleskopowa
GB Telescopic handle
D Teleskopstange
RUS Рукотка телескопическая

CZ Teleskopický prodlužovač
RO Prelungitor telescopic
H Teleszkópos hosszabbító
E Tubo de prolongación telescópico

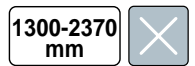

FLO

No.	L (mm)	
99315	1300-2370	12

PL Nożyce do żywoplotu
GB Hedge shears
D Heckenschere
RUS Кусторезы
CZ Nožnice na živý plot
RO Foarfeca pt. gard viu
H Sövényvágó olló
E Tijeras para seto vivo



FLO

No.	L (mm)	
99005	550	20

PL Nożyce do żywoplotu
GB Hedge shears
D Heckenschere
RUS Кусторезы
CZ Nožnice na živý plot
RO Foarfeca pt. gard viu
H Sövényvágó olló
E Tijeras para seto vivo



FLO

No.	L (mm)	blade / ostrze L (mm)	
99007	590	185	18
99008	620	215	18

PL Nożyce do żywoplotu
GB Hedge shears
D Heckenschere
RUS Кусторезы

CZ Nožnice na živý plot
RO Foarfeca pt. gard viu
H Sívényvágó olló
E Tijeras para seto vivo



FLO

No.	L (mm)	
99009	650-860	12

PL Nożyce do trawy wielopozycyjne
GB Grass shears
D Handgrassschere
RUS Ножницы для стрижки травы

CZ Nůžky na trávu
RO Foarfeca pt. gazon
H Forgatható fűvirító olló
E Tijeras de cesped

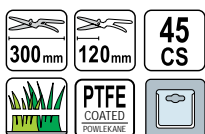

FLO

No.	L (mm)	
99301	300	12/48

PL Pila do gałęzi składana
GB Pruning saw
D Baumsäge
RUS Пила садовая

CZ Zahradnická pila
RO Fierăstrău pt. perforare
H Gallyazófűrész
E Sierra para ramos plegable



FLO

No.	L (mm)	
28641	180	20/60

PL Pila kabląkowa
GB Bow saw
D Bùgelsäge
RUS Лучковая пила

CZ Oblouková pila
RO Ferăstrău de curbură
H Keretes fűrész
E Sierra de arco



No.	L (mm)	
28740	525	24
28750	750	24

PL Nożyce do trawy wielopozycyjne
GB Grass shears
D Handgrassschere
RUS Ножницы для стрижки травы

CZ Nůžky na trávu
RO Foarfeca pt. gazon
H Forgatható fűvirító olló
E Tijeras de cesped

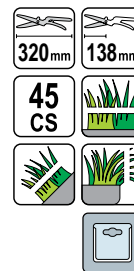

FLO

No.	L (mm)	
99300	320	12/48

PL Pila ogrodnicza - lisi ogon
GB Pruning saw
D Baumsäge
RUS Пила садовая

CZ Zahradnická pila - liščí ocas
RO Fierăstrău de grădină-coadă de vulpe
H Gallyazófűrész-rókafarkú
E Sierra de jardín - cola de zorro

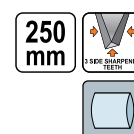

FLO

No.	L (mm)	
28640	250	12/120

PL Pila do gałęzi z kaburą
GB Pruning saw
D Baumsäge
RUS Пила садовая

CZ Zahradnická pila
RO Fierăstrău pt. perforare
H Gallyazófűrész
E Sierra de jardín

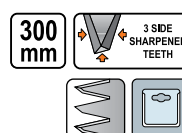

FLO

No.	L (mm)	
28642	300	12/36

PL Pila kabląkowa
GB Bow saw
D Bùgelsäge
RUS Лучковая пила

CZ Oblouková pila
RO Ferăstrău de curbură
H Keretes fűrész
E Sierra de arco



FLO

No.	L (mm)	
28745	530	12/24

PL Pila kabląkowa
GB Bow saw
D Bügelsäge
RUS Лучковая пила

CZ Oblouková pila
RO Ferăstrău de curbură
H Keretes fűrész
E Sierra de arco



FLO

No.	L (mm)	
28746	610	12/24
28755	760	12/24

PL Siekiera ze stali kutej
GB Drop forged hatchet
D Handbeil
RUS Топор стальной кованный

CZ Sekyryka
RO Toporişca lama forjată
H Kovácsolt acél fejsze
E Hacha de metalo forjado



FLO

No.	g	
33080	800	12/24

PL Siekiera
GB Axe
D Handbeil
RUS Топор

CZ Sekyryka
RO Toporişca
H Szekerce
E Hacha



FLO

No.	g	
32930	1000	10

PL Brzeczczot
GB Spare blade for bow saw
D Bügelsägeblatt
RUS Полотно д/пилы „Лидер”

CZ Ostří na dřevo
RO Panza fierastrau tip arc
H Fűrészlap fához
E Hoja de sierra

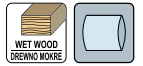

FLO

No.	L (mm)	W (mm)	
28771	530	20	60/240
28772	610	20	60/240
28773	760	20	60/240

PL Siekiera
GB Axe
D Handbeil
RUS Топор

CZ Sekyryka
RO Toporişca
H Szekerce
E Hacha



FLO

No.	g	
33067	600	24
33087	800	20
33107	1000	12
33127	1250	12
33147	1400	12
33177	1600	12

PL Siekiera, rączka z włókna szklanego
GB Axe with fibreglass + PVC handle
D Handbeil Fiberglasstiel
RUS Топор с фиброглассовой ручкой

CZ Sekyryka
RO Toporişca cu coada din fibra de sticla
H Szekerce
E Hacha con mango de fibra de vidrio



VOREL

No.	g	
33065	600	20
33085	800	20
33105	1000	12
33125	1250	6

PL Siekiera CZ Sekyrka
GB Axe RO Toporisca
D Handbeil H Szekeerce
RUS Топор E Hacha



JUKO

No.	g	DIN	
33024	400	5131	5
33026	600	5131	5
33028	800	5131	5
33030	1000	5131	5
33032	1250	7294	5
33035	1500	7294	5
33038	1800	7294	5
33039	2000	7294	5
33040	2500	7294	5

PL Zestaw siekier tradycyjnych CZ Sada klasických seker
GB Axe set RO Set topoare
D Satz traditioneller Äxte H Hagymányos balta készlet
RUS Набор традиционных топоров E Set de hechas tradicionales



JUKO

No.	kg	
32999	0.4; 1.5	5

PL Siekiero-młot CZ Sekera-kladivo
GB Hammer-axe for wood splitting RO Secure-ciocan
D Spaltaxt H Szekeerce-kalapács
RUS Топор-колун E Hacha martillo para partir madera



JUKO

No.	kg	
32925	2.5	1
32926	4.0	1

PL Siekiera kanadyjska CZ Sekera kanadská
GB Canadian axe RO Topor canadian
D Handbeil „Kanadische Form“ H Hosszú nyelű, hasító fejsze
RUS Топор тип канадский E Hacha canada

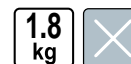

JUKO

No.	kg	
33022	1.8	5

PL Siekiera CZ Sekyrka
GB Axe RO Toporisca
D Handbeil H Szekeerce
RUS Топор E Hacha



JUKO

No.	g	DIN	
33000	400	5131	5
33001	600	5131	5
33002	800	5131	5
33003	1000	5131	5
33004	1250	7294	5
33005	1500	7294	5
33006	1800	7294	5
33007	2000	7294	5
33008	2500	7294	5

PL Siekiera z klinem CZ Sekyrka
GB Axe RO Toporisca
D Handbeil H Szekeerce
RUS Топор E Hacha



JUKO

No.	kg	
32924	2	5

PL Siekiero-młot CZ Sekera-kladivo
GB Hammer-axe for wood splitting RO Secure-ciocan
D Spaltaxt H Szekeerce-kalapács
RUS Топор-колун E Hacha martillo para partir madera



JUKO

No.	kg	
32927	2.1	1
32928	3.2	1



PL Zestaw klinujący CZ Sada klinků
 GB Hammer wedges RO Set cultivator
 D Keilesatz H Ékelő készlet
 RUS Набор клинов E Juego de sujeción

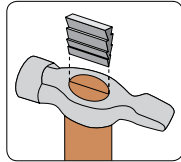
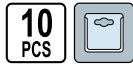

No.	pcs	Box icon
99472	10	6/72

PL Zestaw klinujący CZ Sada klinků
 GB Hammer wedges RO Set cultivator
 D Keilesatz H Ékelő készlet
 RUS Набор клинов E Juego de sujeción



No.	for hammer / do młotka (kg)	for axe / do siekiery (kg)	Box icon
99463	5-6	0.6-1.0	50
99464	8-10	1.2-2.5	50

PL Łopátka CZ Lopátka
 GB Trowel RO Mini-lopată gradinarit
 D Blumenkelle H Ásó
 RUS Сокoв посадочный E Paleta ancha



No.	L (mm)	Box icon
99048	350	25/100

PL Grabki CZ Hraěičky
 GB Rake RO Mini grebla
 D Kleinrechen H Gerebye
 RUS Грабли E Rastrillo



No.	L (mm)	Box icon
99051	300	25/100

PL Zestaw klinujący CZ Sada klinků
 GB Hammer wedges RO Set cultivator
 D Keilesatz H Ékelő készlet
 RUS Набор клинов E Juego de sujeción



No.	for hammer / do młotka (kg)	for axe / do siekiery (kg)	Box icon
99460	0.1-0.5	-	50
99461	0.7-2.0	-	50
99462	3.0-4.0	0.4	50

PL Klin do rozłupywania drewna CZ Klin na řtípání polen
 GB Wood splitter RO Pana pt. lemn
 D Spaltkeil H Fahasító ék
 RUS Клиn для раскалывания бревен E Cuña para partir madera



No.	kg	Box icon
32922	2	1
32923	3	1

PL Łopátka CZ Lopátka
 GB Trowel RO Mini-lopată gradinarit
 D Blumenkelle H Ásó
 RUS Сокoв посадочный E Paleta ancha



No.	L (mm)	Box icon
99047	350	25/100

PL Motyczka z pazurkami CZ Motyčka s hraěičkami
 GB Hoe + cultivator RO Sapaliga + cultivator
 D Kleinhacke H Kerti villás kapa
 RUS Рыхлитель комбинированный E Azadilla con escarificador



No.	L (mm)	Box icon
99050	300	25/50

PL Motyczka
GB Hoe
D Garten Handhacke
RUS Мотыжка

CZ Motyčka
RO Săpăligă
H Kerti kapa
E Azadilla

300
mm



No.	L (mm)	
99052	300	25/100

PL Łopatka
GB Trowel
D Blumenkelle
RUS Совок посадочный

CZ Lopátka
RO Mini-lopata gradinarit
H Ásó
E Paleta ancha

320
mm



No.	L (mm)	
35765	320	50

PL Pazurki
GB Cultivator
D Grubber
RUS Рылитель садовый

CZ Kultivátor
RO Cultivator
H Kultivátor
E Escarificador

330
mm



No.	L (mm)	
35767	330	50

PL Łopatka
GB Trowel
D Blumenkelle
RUS Совок посадочный

CZ Lopátka
RO Mini-lopata gradinarit
H Ásó
E Paleta ancha

330
mm



No.	L (mm)	
99035	330	24/48

PL Pazurki
GB Cultivator
D Grubber
RUS Рылитель садовый

CZ Kultivátor
RO Cultivator
H Kultivátor
E Escarificador

310
mm



No.	L (mm)	
99049	310	25/100

PL Łopatka
GB Trowel
D Blumenkelle
RUS Совок посадочный

CZ Motyčka
RO Săpăligă
H Kerti kapa
E Azadilla

350
mm



No.	L (mm)	
35768	350	50

PL Łopatka
GB Trowel
D Blumenkelle
RUS Совок посадочный

CZ Lopátka
RO Mini-lopata gradinarit
H Ásó
E Paleta ancha

330
mm



No.	L (mm)	
99034	330	24/48

PL Grabki
GB Rake
D Kleinrechen
RUS Грабли

CZ Hrabičky
RO Mini grebla
H Gereblye
E Rastrillo

300
mm



No.	L (mm)	
99036	300	24/48

PL Motyczka z pazurkami
GB Hoe + cultivator
D Kleinhacke
RUS Рыхлитель комбинированный

CZ Motyčka s hrabičkami
RO Sapaliga + cultivator
H Kerti villás kapa
E Azadilla con escarificador

300 mm



FLO

No.	L (mm)	
99037	300	24/48

PL Grabki
GB Rake
D Kleinrechen
RUS Грабли

CZ Hrabičky
RO Mini grebla
H Gereblye
E Rastrillo

450 mm



FLO

No.	L (mm)	
99039	450	24/48

PL Sadzarka do cebuli
GB Bulb planter
D Blumenzweibelpflanzer
RUS Конус посадочный для рассады

CZ Sazeč
RO Plantator
H Palántázó
E Plantadora para cebollas



FLO

No.	
99033	10/60

PL Saperka wielofunkcyjna
GB Multifunctional shovel
D Kombi-Faltschaufel
RUS Складная лопата многофункциональная

CZ Lopatka víceúčelová
RO Lopata multifunctionala
H Többfunkciós ásó
E Zapadora multifuncion



FLO

No.	
99053	36

PL Pazurki
GB Cultivator
D Grubber
RUS Рыхлитель садовый

CZ Kultivátor
RO Cultivator
H Kultivátor
E Escarificador

395 mm



FLO

No.	L (mm)	
99038	395	24/48

PL Chwastownik
GB Patio weeder
D Fugenkratzer
RUS Очиститель щелевой

CZ Čistič mezer
RO Cuțit pt. curățat dale
H Fugakaparó
E Musgo cuchillo

320 mm



FLO

No.	L (mm)	
99040	320	24/48

PL Zbierak do owoców
GB Fruit pick up tool
D Obstpfücker
RUS Съёмник для фруктов

CZ Sběrač ovoce
RO Culegator pt. fructe
H Karos gyümölcszedő
E Recolector de frutas



FLO

No.	Ø (mm)	
89880	160	12/48

PL Saperka składana
GB Folding shovel
D Faltschaufel
RUS Складная лопата

CZ Lopatka skládací
RO Lopata demontabila
H Öszecsukható ásó
E Zapadora desmontable



FLO

No.	
99054	36

PL Komplet narzędzi ogrodowych
GB Garden tool set
D Garten-Kleingerätesatz
RUS Набор садово-огородного инструмента

CZ Sada zahradnického náčiní
RO Set pt. grădinărit
H Kertész készlet
E Juego de herramientas de jardín



FLO

No.	L (mm)	Icon
99028	205	50

PL Walec ogrodowy
GB Garden roller
D Gartenwalze
RUS Садовый валик
CZ Zahradní válec
RO Tavalug gradina
H Kerti henger
E Rodillo de jardín



FLO

No.	working part width / szerokość części roboczej (mm)	Icon
88720	500	1

PL Szpadel
GB Spade
D Rodespaten
RUS Заступ

CZ Lisovaný rýč kalená
RO Hârleț cu coadă
H Ásó, sajított-edzett
E Pala



FLO

No.	type	Icon
35809	DY	200

PL Saperka profilowana
GB Mini shovel
D Feldspaten
RUS Лопата саперная

CZ Vojenská lopata
RO Lopată mică
H Profilozott ásó
E Zapa perflada



24 FLO

No.	type	Icon
35833	DY	250

PL Komplet narzędzi ogrodowych
GB Garden tool set
D Garten-Kleingerätesatz
RUS Набор садово-огородного инструмента

CZ Sada zahradnického náčiní
RO Set pt. grădinărit
H Kertész készlet
E Juego de herramientas de jardín



FLO

No.	pcs	Icon
99056	4	10/60

PL Szpadel szkółkarski
GB Transplanting spade
D Schulspaten
RUS Лопата штыковая дренажная

CZ Školkářský rýč
RO Cazma de puiet
H Faiskolai ásó
E Pala de vivero



FLO

No.	type	Icon
35811	DY	140

PL Szpadel
GB Spade
D Rodespaten
RUS Заступ

CZ Lisovaný rýč kalená
RO Hârleț cu coadă
H Ásó, sajított-edzett
E Pala



FLO

No.	type	Icon
35810	DY	200

PL Łopata piaskowa
GB Shovel
D Schaufel
RUS Лопата совковая песочная

CZ Osazený rýč pískový
RO Lopată pt. nisip
H Homoklapát
E Pala arena



FLO

No.	type	Icon
35843	DY	120

PL Łopata piaskowo - żwirowa
GB Shovel
D Schaufel
RUS Лопата совковая песчаная

CZ Osazený ryč pískový
RO Lopată pt. nisip
H Homoklapát
E Pala arena



No.	type	
35861	DY	120

PL Łopata węglowa
GB Shovel
D Kohlschaufel
RUS Лопата угольная

CZ Úhlový ryč čisto
RO Lopată pt. cărbune
H Szeneslapát
E Pala carbón



No.	type	
35863	DY	120

PL Grabie
GB Rake
D Rechen
RUS Грабли

CZ Hrábě
RO Greblă
H Gereblye
E Rastrillo



No.	teeth / zęby	type	
35756	10	P	250
35757	12	P	250
35758	14	P	250
35759	16	P	250

PL Kultywator ręczny oprawiony
GB Hand cultivator with handle
D Handkultivator, eingefasst
RUS Культиватор ручной садовый

CZ Ruční kultivátor s násadou
RO Cultivator cu maner
H Kézi kultivátor, nyeles
E Cultivador manual enmarcado



No.	type	
35701	P	250

PL Łopata kanadyjska
GB Gardening shovel
D Kanadischer Spaten
RUS Лопата канадская

CZ Ryci lopata
RO Lopată canadiană
H Ásólapát
E Pala canadiense



No.	type	
35855	DY	140

PL Widły
GB Digging fork
D Grabegabel
RUS Вилы свекловичные кованые

CZ Zahradnické vidlice
RO Furcă pt. grădină
H Vasvilla
E Horca



No.	type	
35817	DY	200

PL Motyka
GB Garden hoe
D Garten Handhacke
RUS Тяпка

CZ Motyčka
RO Sapalga
H Kerti kapa
E Azadilla



No.	working part width / szer. części roboczej (cm)	type	
35761	12	P	500
35762	14	P	250

PL Pazurki oprawione
GB Cultivator
D Grubber
RUS Рыхлитель садовый

CZ Kultivátor
RO Cultivator
H Kultivátor
E Escarificador



No.	type	
35705	P	250

PL Grabie wachlarzowe
GB Spring rake
D Landschaftsbesen
RUS Грабли веерные

CZ Hraňičky
RO Grebla de gradina
H Kerti gereblye
E Rastrillo de abanico de hojalata

120 cm



FLO

No.	working part width / szer. części roboczej (cm)	teeth / zęby	
35799	40	21	250

PL Świerdło ręczne do gleby
GB Gimlet to the soil
D Handbohrer für den Erdboden
RUS Ручной почвенный бур

CZ Ruční vrták do půdy
RO Sfredel manual pt. pământ
H Kézi talajfúró
E Taladro manual para suelo



FLO

No.	Ø (mm)	
35670	170	50
35671	250	24

PL Szpadel
GB Spade
D Rodespaten
RUS Заступ

CZ Lisovaný rýč kalená
RO Hârleț cu coadă
H Ásó, sajított-edzett
E Pala

T



FLO

No.	type	
35800	T	140

PL Szpadel
GB Spade
D Rodespaten
RUS Заступ

CZ Lisovaný rýč kalená
RO Hârleț cu coadă
H Ásó, sajított-edzett
E Pala

T



No.	type	
35801	T	200

PL Grabie wachlarzowe regulowane
GB Shrub rake
D Laubbesen Fächerbesen Regulierbar
RUS Грабли веерные регулируемые

CZ Hrábě vějířovitě nastavitelné
RO Greblă evantai reglabilă
H Állítható lombseprű
E Rastrillos ventilador ajustables

P



FLO

No.	working part width / szer. części roboczej (mm)	teeth / zęby	
35797	255 / 580	20	5

PL Nóż do darni
GB Long handle steel edger
D Rasenkantenstecher
RUS Полулунный нож для обрезки краев дерна

CZ Nůz na okraje travniku
RO Taietor de borduri
H Gyepgondozás
E Cortador de bordes para césped

P



FLO

No.	working part width / szer. części roboczej (mm)	type	
35680	200	P	250

PL Szpadel
GB Spade
D Rodespaten
RUS Заступ

CZ Lisovaný rýč kalená
RO Hârleț cu coadă
H Ásó, sajított-edzett
E Pala

T



FLO

No.	type	
35802	T	140

PL Szpadel
GB Spade
D Rodespaten
RUS Заступ

CZ Lisovaný rýč kalená
RO Hârleț cu coadă
H Ásó, sajított-edzett
E Pala

DY



FLO

No.	type	
35803	DY	140

PL Szpadel CZ Lisovaný ryč kalená
 GB Spade RO Hârleț cu coadă
 D Rodespaten H Ásó, sajtolt-edzett
 RUS Заступ E Pala



No.	type	
35805	DY	140

PL Szpadel drenarski, nitowany CZ Ryč drenážní nýtovaný
 GB Riveted drainage spade RO Sapă drenaj nitut
 D Drainagespaten, genietet H Szegecselt drénező ásó
 RUS Лопата дренажная сборная E Pala de drenaje remachada



No.	type	
35807	T	140

PL Łopata piaskowa CZ Osazený ryč pískový
 GB Shovel RO Lopată pt. nisip
 D Schaufel H Homoklapát
 RUS Лопата совковая песочная E Pala arena



No.	type	
35839	DY	120

PL Łopata CZ Lopata
 GB Shovel RO Lopată
 D Schaufel H Homoklapát
 RUS Лопата E Pala



No.	type	
35846	DY	100

PL Szpadel CZ Lisovaný ryč kalená
 GB Spade RO Hârleț cu coadă
 D Rodespaten H Ásó, sajtolt-edzett
 RUS Заступ E Pala



No.	type	
35806	DY	140

PL Szpadel drenarski, profilowany CZ Ryč drenážní profilovaný
 GB Roll formed drainage spade RO Sapă drenaj profilată
 D Drainagespaten, profiliert H Profilizott drénező ásó
 RUS Лопата дренажная цельноштампованная E Pala de drenaje perfilada



No.	type	
35808	DY	140

PL Łopata piaskowa CZ Osazený ryč pískový
 GB Shovel RO Lopată pt. nisip
 D Schaufel H Homoklapát
 RUS Лопата совковая песочная E Pala arena



No.	type	
35840	T	200

PL Łopata węglowa CZ Úhlový ryč číslu
 GB Shovel RO Lopată pt. cărbune
 D Kohlschaufel H Szeneslapát
 RUS Лопата угольная E Pala carbón



No.	type	
35850	T	120

PL Łopata węglowa
GB Shovel
D Kohlenschaufel
RUS Лопата угольная

CZ Úhlový ryč číslo
RO Lopată pt. cărbune
H Szeneslapát
E Pala carbón



No.	type	☐
35860	DY	90

PL Widły
GB Digging fork
D Grabegabel
RUS Вилы севкловичные кованые

CZ Zahradnické vidlice
RO Furcă pt. grădină
H Vasvilla
E Horca



No.	teeth / zęby	type	☐
35815	3	P	100
35816	4	P	200

PL Widły
GB Digging fork
D Grabegabel
RUS Вилы севкловичные кованые

CZ Zahradnické vidlice
RO Furcă pt. grădină
H Vasvilla
E Horca



No.	teeth / zęby	type	☐
35813	4	DY	140

PL Pazurki uprawiane
GB Cultivator
D Grubber
RUS Рыхлитель садовый

CZ Kultivátor
RO Cultivator
H Kultivátor
E Escarificador



No.	type	☐
35763	P	5

PL Łopata piaskowa
GB Shovel
D Schaufel
RUS Лопата совковая песочная

CZ Osazený ryč pískový
RO Lopată pt. nisip
H Homoklapát
E Pala arena



No.	L (cm)	type	☐
35842	135	P	100

PL Widły
GB Digging fork
D Grabegabel
RUS Вилы севкловичные кованые

CZ Zahradnické vidlice
RO Furcă pt. grădină
H Vasvilla
E Horca



No.	teeth / zęby	type	☐
35865	4	DY	140

PL Widły
GB Digging fork
D Grabegabel
RUS Вилы севкловичные кованые

CZ Zahradnické vidlice
RO Furcă pt. grădină
H Vasvilla
E Horca



No.	teeth / zęby	type	☐
35864	4	DY	140

PL Grabie
GB Rake
D Rechen
RUS Грабли

CZ Hrábě
RO Greblă
H Gereblye
E Rastrillo



No.	teeth / zęby	type	☐
35740	6	P	10
35741	8	P	10
35781	10	P	10
35782	12	P	10
35784	14	P	10
35783	16	P	10

PL Grabie CZ Hrabě
 GB Rake RO Greblă
 D Rechen H Gereblye
 RUS Грабли E Rastrillo

150 cm



No.	L (cm)	teeth / zęby	
35779	150	12	150
35780	150	16	155

PL Grabie wachlarzowe CZ Hrabíčky
 GB Spring rake RO Grebla de gradina
 D Landschaftsbesen H Kerti gereblye
 RUS Грабли веерные E Rastrillo de abanico de hojalata

390 mm



No.	L (mm)	teeth / zęby	
35798	390	21	58

PL Motyczka z pazurkami CZ Motyčka s hrabičkami
 GB Hoe + cultivator RO Sapaliga + cultivator
 D Kleinhacke H Kerti villás kapa
 RUS Рыхлитель комбинированный E Azadilla con escarificador

P



No.	type	
35764	P	5

PL Motyka CZ Motyčka
 GB Garden hoe RO Sapaliga
 D Garten Handhacke H Kerti kapa
 RUS Тяпка E Azadilla

P



No.	working part width / szer. części roboczej (cm)	type	
35770	17	P	5

PL Grabie wachlarzowe CZ Hrabíčky
 GB Spring rake RO Grebla de gradina
 D Landschaftsbesen H Kerti gereblye
 RUS Грабли веерные E Rastrillo de abanico de hojalata

X



No.	L (mm)	teeth / zęby	
35785	435	23	12

PL Grabie wachlarzowe metalowe
 GB Metal fan rake
 D Metall-Fächerbesen
 RUS Грабли для уборки листьев металлические
 CZ Kovové vějířové hrábě
 RO Greblă evantai de metal
 H Fém levelgereblye
 E Rastrillo de abanico de metal

530 mm



No.	L (mm)	
99400	530	24

PL Motyczka z pazurkami CZ Motyčka s hrabičkami
 GB Hoe + cultivator RO Sapaliga + cultivator
 D Kleinhacke H Kerti villás kapa
 RUS Рыхлитель комбинированный E Azadilla con escarificador

P



No.	type	
35792	P	5

PL Motyka CZ Motyčka
 GB Garden hoe RO Sapaliga
 D Garten Handhacke H Kerti kapa
 RUS Тяпка E Azadilla

P



No.	working part width / szer. części roboczej (cm)	type	
35773	12	P	500
35774	14	P	250
35776	16	P	5

PL Motyka CZ Motyčka
 GB Garden hoe RO Sapaliga
 D Garten Handhacke H Kerti kapa
 RUS Тяпка E Azadilla



No.	working part width / szer. części roboczej (cm)	type	
35777	17	P	5

PL Wertykulator do trawy CZ Kultivátor oboustranný
 GB Grass cultivator RO Cultivator
 D Schneidrechen H Kétoldalas talajazító, gyephez
 RUS Грабли азрационные E Cultivador de dos lados



No.	L (mm)	
35700	380	5/10

PL Grabie CZ Hrásbě
 GB Rake RO Greblă
 D Rechen H Gereblye
 RUS Грабли E Rastrillo



No.	L (mm)	teeth / zęby	
35755	360	14	20

PL Grabie wachlarzowe CZ Hraňičky
 GB Spring rake RO Grebla de gradina
 D Landschaftsbesen H Kerti gereblye
 RUS Грабли веерные E Rastrillo de abanico de hojalata



No.	L (mm)	teeth / zęby	
35787	455	20	10

PL Grabie plastikowe CZ Plastové hrábě
 GB Plastic rake RO Greblă de plastic
 D Plasteharken H Műanyag gereblye
 RUS Грабли пластиковые E Rastrillo de plástico



No.	L (mm)	teeth / zęby	
35788	550	16	10
35789	590	18	10

PL Grabie CZ Hrásbě
 GB Rake RO Greblă
 D Rechen H Gereblye
 RUS Грабли E Rastrillo

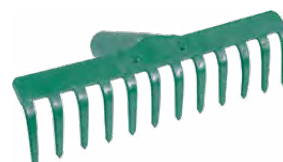

No.	L (mm)	teeth / zęby	
35750	270	12	48
35751	340	14	28

PL Grabie wachlarzowe CZ Hraňičky
 GB Spring rake RO Grebla de gradina
 D Landschaftsbesen H Kerti gereblye
 RUS Грабли веерные E Rastrillo de abanico de hojalata



No.	L (mm)	teeth / zęby	
35786	435	23	10

PL Grabie wachlarzowe CZ Hraňičky
 GB Spring rake RO Grebla de gradina
 D Landschaftsbesen H Kerti gereblye
 RUS Грабли веерные E Rastrillo de abanico de hojalata



No.	L (mm)	teeth / zęby	
35790	435	20	20
35791	580	27	20

PL Grabie wachlarzowe metalowe
 GB Metal fan rake
 D Metall-Fächerbesen
 RUS Грабли для уборки листьев металлические
 CZ Kovové vějířové hrábě
 RO Greblă evantai de metal
 H Fém levelgeregelye
 E Rastrillo de abanico de metal

430 mm



No.	L (mm)	
99390	430	40

PL Grabie wachlarzowe metalowe
 GB Metal fan rake
 D Metall-Fächerbesen
 RUS Грабли для уборки листьев металлические
 CZ Kovové vějířové hrábě
 RO Greblă evantai de metal
 H Fém levelgeregelye
 E Rastrillo de abanico de metal

425 mm



No.	L (mm)	
99401	425	60

PL Obsypnik
 GB Cultivator
 D Häufler
 RUS Культиватор

CZ Zасыпávač
 RO Cultivator
 H Kultivátor
 E Arado

190 mm



No.	L (mm)	
35710	190	5/15

PL Motyczka z pazurkami
 GB Hoe + cultivator
 D Kleinhacke
 RUS Рыхлитель комбинированный

CZ Motyčka s hrabičkami
 RO Sapaliga + cultivator
 H Kerti villás kapa
 E Azadilla con escarificador

80 mm



No.	L (mm)	
35760	80	60

PL Grabie wachlarzowe metalowe
 GB Metal fan rake
 D Metall-Fächerbesen
 RUS Грабли для уборки листьев металлические
 CZ Kovové vějířové hrábě
 RO Greblă evantai de metal
 H Fém levelgeregelye
 E Rastrillo de abanico de metal

460 mm



No.	L (mm)	
99391	460	50

PL Pazurki
 GB Cultivator
 D Grubber
 RUS Рыхлитель садовый

CZ Kultivátor
 RO Cultivator
 H Kultivátor
 E Escarificador

X



No.	L (mm)	
35793	100	60
35794	130	60

PL Motyczka
 GB Hoe
 D Garten Handhacke
 RUS Мотыжка

CZ Motyčka
 RO Săpăligă
 H Kerti kapa
 E Azadilla

160 mm



No.	L (mm)	
35775	160	30

PL Motyczka z pazurkami
 GB Hoe + cultivator
 D Kleinhacke
 RUS Рыхлитель комбинированный

CZ Motyčka s hrabičkami
 RO Sapaliga + cultivator
 H Kerti villás kapa
 E Azadilla con escarificador

70 mm



No.	L (mm)	
35795	70	60

PL Miotła
GB Broom
D Strassenbesen
RUS Метла

CZ Metla
RO Matura
H Partvis
E Cepillo pelo largo



No.	L (mm)	
35911	1150x250	140

PL Miotła
GB Broom
D Strassenbesen
RUS Метла

CZ Metla
RO Matura
H Partvis
E Cepillo pelo largo



No.	L (mm)	
35893	300	12
35894	400	12
35895	500	12

PL Miotła
GB Broom
D Strassenbesen
RUS Метла

CZ Metla
RO Matura
H Partvis
E Cepillo pelo largo



No.	bristle length / długość włosia (mm)	
35905	275	12

PL Miotła
GB Broom
D Strassenbesen
RUS Метла

CZ Metla
RO Matura
H Partvis
E Cepillo pelo largo



No.	bristle length / długość włosia (mm)	
35908	210	8

PL Miotła
GB Broom
D Strassenbesen
RUS Метла

CZ Metla
RO Matura
H Partvis
E Cepillo pelo largo



No.	L (mm)	
35912	1200x360	15

PL Miotła
GB Broom
D Strassenbesen
RUS Метла

CZ Metla
RO Matura
H Partvis
E Cepillo pelo largo



No.	L (mm)	
35899	250	12

PL Miotła
GB Broom
D Strassenbesen
RUS Метла

CZ Metla
RO Matura
H Partvis
E Cepillo pelo largo



No.	bristle length / długość włosia (mm)	
35906	135	12

PL Szczotka do kosiarki
GB Lawn mover brush
D Rasenmäher Reinigungsbürste mit Schaber
RUS Щетка для очистки газонокосилки

CZ Kartáč na čistění sekačky
RO Perie pt. curatat motocoase
H Ecset a kaszák tisztításához
E Cepillo limpieza



No.	mm	
35950	310x50	15

PL Sierp
GB Sickle
D Sichel
RUS Сепь

CZ Srp
RO Secera
H Sarló
E Hoz



No.		
35832		30

PL Klepadło do kos
GB Stake for scythe
D Dengelamboss für Sensen
RUS Бабка для отбивки кос (наковальня)

CZ Naklepávací kovadlinka
RO Inel de stângere - pt. coasă
H Kaszarögzítő gyűrű
E Anillo para guadanas



No.		
35831		30

PL Klin drewniany do kosy
GB Wedge for scythe
D Holzkeil für Sensen
RUS Клиn деревянный для косы

CZ Klín dřevěný na kosu
RO Pană de lemn pt. coasă
H Faék kaszarához
E Cuna de madera para guadanas



No.		
35831		12/144

PL Trzonek uniwersalny
GB Wooden handle
D Universalsstiel
RUS Черенок для грабель

CZ Násada univerzální
RO Coada din lemn
H Univerzális nyél
E Astil universal



No.	L (cm)	Ø (mm)	type	
99403	100	28	P	25
99404	110	28	P	25
99402	130	28	P	25
99408	150	28	P	25

PL Kosa kuta
GB Forged scythe
D Sensenklänge geschmiedet
RUS Коса

CZ Kosa kovaná
RO Lama de coasa
H Kovácsoló kasza
E Guadana forjada



No.	type	
35824	No 6	25
35826	No 7	25
35828	No 8	25

PL Pierścień do kosy
GB Ring for scythe
D Befestigungsring für sense Verzinkt
RUS Кольцо косное оцинкованное

CZ Kroužek na kosu
RO Bratară galvanizată pt. coasa
H Kaszarögzítő gyűrű
E Anillo para guadana



No.		
35823		30

PL Trzonek do kosy
GB Wooden handle for scythe
D Sensenstiel
RUS Косовище деревянное

CZ Násada na kosu
RO Coada de coasa
H Kaszanyél
E Astil para guadanas

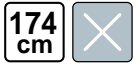

No.	L (cm)	
35830	174	10

PL Trzonek do łopaty
GB Wooden handle for shovel
D Schaufelstiel gerade
RUS Черенок для лопаты

CZ Násada na lopatu
RO Coada din lemn
H Lapátnyél
E Astil para pala



No.	L (cm)	type	
99410	130	P	10

PL Trzonek do grabi wachlarzowych
GB Wooden handle
D Schaufelstiel P-Griff
RUS Черенок для лопат

CZ Násada na lopatu
RO Coadă de lopată cu maner
H Lapátnyél
E Astil para pala



No.	L (cm)	Ø (mm)	type	
99415	130	21	P	25

PL Trzonek do miotły ulicznej
GB Broom handle for broom
D Stiel für einen Straßenbesen
RUS Черенок для метлы

CZ Násada na silniční metlu
RO Coadă matura cu filet
H Utcaseprűnyél
E Palo de escoba de calle



No.	L (cm)	
99421	150	25

PL Trzonek do miotły z gwintem
GB Broom handle with thread
D Besenstiel, holz, mit Gewinde
RUS Черенок для метлы с резьбой

CZ Násada na metlu se závitem
RO Coadă de mătură cu filet
H Menetes seprűnyél
E Astil para escoba con rosca



No.	L (cm)	type	
99418	120	P	25

PL Trzonek do szpadla
GB Handle „T” for spade
D Spadelstiel T-griff
RUS Черенок для лопаты

CZ Násada na rýč
RO Coadă din lemn
H Ásónyél
E Astil para laya



No.	L (cm)	type	
99407	90	T	10

PL Trzonek do miotły ulicznej
GB Broom handle for broom
D Stiel für einen Straßenbesen
RUS Черенок для метлы

CZ Násada na silniční metlu
RO Coadă matura cu filet
H Utcaseprűnyél
E Palo de escoba de calle



VOREL

No.	L (cm)	
99420	125	25

PL Trzonek do miotły z gwintem
GB Broom handle with thread
D Besenstiel, holz, mit Gewinde
RUS Черенок для метлы с резьбой

CZ Násada na metlu se závitem
RO Coadă de mătură cu filet
H Menetes seprűnyél
E Astil para escoba con rosca



No.	L (cm)	Ø (mm)	type	
99416	120	22	P	25

PL Trzonek metalowy z gwintem
GB Steel handle with thread
D Besenstiel mit Gewinde
RUS Черенок с резьбой

CZ Násada na metlu se závitem
RO Coadă cu filet
H Menetes seprűnyél
E Astil para escoba con rosca



FLO

No.	L (cm)	Ø (mm)	
99419	116	22	24

PL Trzonek do lopaty
GB Wooden handle for shovel
D Schaufelstiel gerade
RUS Черенок для лопаты

CZ Násada na lopatu
RO Coadă din lemn
H Lapátnyél
E Astil para pala



No.	L (cm)	type	
99409	115	T	10

PL Trzonek
GB Wooden handle
D Schaufelstiel D-Griff
RUS Черенок для лопат

CZ Násada na lopatu
RO Coada de lopata cu maner
H Lapátnyél
E Astil para pala



No.	L (cm)	type	
99412	90	DY	10

PL Trzonek do toporka
GB Wooden handle for hammer-axe
D Beilstiel
RUS Черенок для топора

CZ Násada na sekeru - kalač
RO Coada de topor
H Ácsszekerce nyél
E Astil para hacha con martillo



No.	L (cm)	for head / do obucha (kg)	
99425	36	0.6	75
99426	40	0.8	25

PL Trzonek do siekiery
GB Axe handle
D Axtstiel
RUS Рукоятка топора

CZ Topůrko do sekery
RO Cap de topor
H Baltányél
E Astil de hacha



No.	L (cm)	for head / do obucha (kg)	
99427	50	1.0	25
99428	60	1.0-1.25	25
99429	70	1.25-1.80	25

PL Trzonek do młotka
GB Hammer handle
D Hammerstiel
RUS Рукоятка молотка

CZ Topůrko do kladiva
RO Cap de ciocan
H Kalapácsnyél
E Astil de martillo

No.	L (cm)	for head / do obucha (kg)	
99435	28	0.1-0.3	65
99436	32	0.3-0.7	65
99438	36	0.7-1.5	65
99440	40	0.8-2.0	50
99442	50	2.0-3.0	50
99443	60	3.0-4.0	25
99444	70	4.0-6.0	25
99445	80	5.0-8.0	25
99446	90	8.0-10	10

PL Trzonek
GB Wooden handle
D Schaufelstiel D-Griff
RUS Черенок для лопат

CZ Násada na lopatu
RO Coada de lopata cu maner
H Lapátnyél
E Astil para pala



No.	L (cm)	type	
99413	90	DY	10

PL Trzonek do siekiero-mlota
GB Handle for hammer-axe
D Stiel für Hammeraxt
RUS Черенок для топора

CZ Násada na sekeru
RO Coada din lemn
H Baltányél
E Astil para hachuela



No.	L (cm)	for head / do obucha (kg)	
99405	90	2.5	10
99406	90	4.0	10

PL Trzonek do siekiery
GB Axe handle
D Axtstiel
RUS Рукоятка топора

CZ Topůrko do sekery
RO Cap de topor
H Baltányél
E Astil de hacha



No.	L (cm)	for head / do obucha (kg)	
99430	80	1.8-2	25



- PL Spryskiwacz ciśnieniowy ręczny
 GB Pressure sprayer
 D Drucksprüher
 RUS Опрыскиватель ручной
 CZ Ruční tlakový postřikovač
 RO Vermorel
 H Permetező kézi
 E Rociador de presión, de mano



FLO

No.	l	
89507	1.0	20
89508	1.5	15
89509	2.0	15

- PL Opryskiwacz ciśnieniowy
 GB Pressure sprayer
 D Drucksprüher
 RUS Опрыскиватель ручной
 CZ Ruční tlakový postřikovač
 RO Pulverizator de mana
 H Permetező kézi
 E Rociador de presión

8L

0.2 MPa



FLO

No.	l	
89520	8.0	6

- PL Pompka do spryskiwacza
 GB Pump for pressure sprayer
 D Druckpumpe für Drucksprüher
 RUS Насос на опрыскиватели
- CZ Pumpa do postřikovače
 RO Pompa pt. vermores
 H Szivattyú esőztetőhöz
 E Bomba para el rociador



FLO

No.	for / dla	
89536	89515; 89518; 89520	60

- PL Opryskiwacz ciśnieniowy
 GB Pressure sprayer
 D Drucksprüher
 RUS Опрыскиватель ручной
 CZ Ruční tlakový postřikovač
 RO Pulverizator de mana
 H Permetező kézi
 E Rociador de presión

0.2 MPa



FLO

No.	l	
89515	5.0	6
89518	8.0	6

- PL Opryskiwacz ciśnieniowy plecakowy
 GB Pressure sprayer
 D Rücken-Drucksprüher
 RUS Опрыскиватель ручной ранцевый
 CZ Tlakový postřikovač zádový
 RO Pulverizator portabil
 H Permetező hát
 E Rociador de presión tipo „mochila”

0.2 MPa



FLO

No.	l	
89526	15.0	1
89528	20.0	1

- PL Końcówka rozpylająca do spryskiwaczy
 GB Straight nozzle for pressure sprayer
 D Sprühdüse für Drucksprüher
 RUS Распылитель на опрыскиватели
 CZ Rozprašovací koncovka k postřikovači
 RO Doza pt. vermores
 H Porlasztó tömlővég esőztetőhöz
 E Puna de atomización para rociador



FLO

No.	for / dla	
89537	89515; 89518; 89520	300

- PL Zestaw końcówek rozpylających
GB Spray nozzle set
D Spritzdüsenatz
RUS Форсунки сменные для опрыскивателей
- CZ Sada rozprašovacích koncovek
RO Set racorduri vermored
H Porlasztó tömlővég készlet
E Juego de boquillas rociadores



FLO

No.

89538



100

- PL Pistolet do opryskiwacza
GB Shower spray gun
D Spritzpistole
RUS Пистолет для опрыскивателей
- CZ Rozprašovaci pistole na vodu
RO Pistol pt. stropit
H Locsoló pisztoly
E Pistola de pulverización ajustable



FLO

No.

89540



200

- PL Lanza teleskopowa
GB Telescopic handle
D Teleskoplanze
RUS Штанга телескопическая для опрыскивателя
- CZ Násadec teleskopický
RO Maner telescopic
H Teleszkópos lándzsa
E Lanza telescópica

70-118
cm



FLO

No.

89542

L (cm)
70-118



100

- PL Zestaw uszczelek do spryskiwaczy
GB Set of gaskets for pressure sprayer
D Dichtungssatz für Drucksprüher
RUS Набор прокладок для опрыскивателя
- CZ Sada těsnění k postřikovači
RO Set de garnituri pt. vermored
H Tömítéskészlet esőztetőhöz
E Juego de juntas para rociadores



FLO

No.

89545

for / dla

89515; 89518; 89520



500

- PL Pistolet do opryskiwacza
GB Shower spray gun
D Spritzpistole
RUS Пистолет для опрыскивателей
- CZ Rozprašovaci pistole na vodu
RO Pistol pt. stropit
H Locsoló pisztoly
E Pistola de pulverización ajustable



FLO

No.

89539



200

- PL Lanca z włókna szklanego
GB Fibreglass spray lance
D Fibreglaslanze
RUS Трубка фиброглассовая
- CZ Násadec postřikovače ze skleněného vlákna
RO Lance din fibra de sticla
H Üveggyapot lándzsa
E Lanza de fibra de vidrio

80
cm



FLO

No.

89541

L (cm)
80

Ø (mm)
8



250

- PL Przyłącze 4-dyszowe
GB 4-nozzle connector
D Querlanze mit 4 Düsen
RUS Штанга с 4 форсунками для опрыскивателей (вертикальная)
- CZ Připojka 4-trysková
RO Sistem irigații
H 4-fűvökás csatlakozó
E Conexión de cuatro surtidores

645
mm



FLO

No.

89543

L (mm)
645



100

- PL Zestaw uszczelek do spryskiwaczy
GB Set of gaskets for pressure sprayer
D Dichtungssatz für Drucksprüher
RUS Набор прокладок для опрыскивателя
- CZ Sada těsnění k postřikovači
RO Set de garnituri pt. vermored
H Tömítéskészlet esőztetőhöz
E Juego de juntas para rociadores



FLO

No.

89547

for / dla

89526; 89528



500

- PL Akumulatorowa podkaszarka do trawy
- GB Cordless grass trimmer
- D Akku-Rasentrimmer
- RUS Аккумуляторные триммеры
- CZ Akumulátorová sekačka na trávu
- RO Trimmer de gazon cu acumulator
- H Akkus szegélynyíró
- E Desmalezadora inalámbrica

18 V 1.5 Ah

8000 min⁻¹

Li-Ion

TAPÉGO SPOOL HEAD TYPE GŁOWICA TYPU TAPÉGO

230 mm

CHARGE LEVEL INDICATOR WSKAZNIK STANU NAŁADOWANIA BATERII



$L_{PA} = 72,4 \pm 3,0$ dB; $L_{WA} = 87,37 \pm 3,0$ dB; $a_n = 1,45 \pm 1,5$ m/s²

No.	V	min-1	Ø (mm)	☐
79510	18	8000	230	2

- PL Akumulatorowe nożyce do trawy i krzewów
- GB Cordless grass and shrub shears
- D Akkschere mit Gras- und Strauchmesser
- RUS Аккумуляторные ножницы для травы и кустов
- CZ Akumulátorové nůžky na trávu a keře
- RO Trimmer cu acumulator pt. iarba si gard viu
- H Foarfecele cu acumulator pt. tăiat iarba
- E Tijeras a batería para hierba y arbustos

3.6 V 1.3 Ah Li-Ion

1000 min⁻¹

Li-Ion

80 mm

2in1

110 mm



$L_{PA} = 74,6 \pm 3,0$ dB; $L_{WA} = 86,4 \pm 3,0$ dB; $a_n = 1,63 \pm 1,5$ m/s²

No.	V	min-1	☐
79500	3.6	1000	8

- PL Akumulatorowe nożyce do żywoplotu
- GB Cordless hedge trimmer
- D Akku-Heckenschere
- RUS Аккумуляторный кусторез
- CZ Akumulátorové nůžky na živé ploty
- RO Akkus sövénynyíró
- H Foarfece de tăiat gard viu cu acumulator
- E Cortasetos inalámbrico

18 V 1.5 Ah 27 Wh

1100 min⁻¹

Li-Ion

440mm

CHARGE LEVEL INDICATOR WSKAZNIK STANU NAŁADOWANIA BATERII



No.	V	min-1	L (mm)	☐
79520	18	1100	440	2

$L_{PA} = 75,19 \pm 3$ dB; $L_{WA} = 86,19 \pm 3$ dB; $a_n = 0,933 \pm 1,5$ m/s²

- PL Podkaszarka elektryczna
- GB Electric trimmer
- D Elektro-Rasentrimmer
- RUS Электрический триммер
- CZ Elektrická sekačka
- RO Cositoare electrică
- H Elektromos fűnyíró
- E Segadora eléctrica

230V~ 50Hz 500 W

10500 min⁻¹

290 mm

100 cm

80 cm

2 POSITIONS POZYCJE



$L_{PA} = 74,4 \pm 1,94$ dB; $L_{WA} = 94,1 \pm 1,94$ dB; $a_n = 0,794 \pm 1,5$ m/s²

No.	W	min-1	Ø (mm)	☐
79467	500	10500	280	4

- PL Akumulatorowe nożyce do trawy i krzewów
- GB Cordless grass and shrub shears
- D Akkschere mit Gras- und Strauchmesser
- RUS Аккумуляторные ножницы для травы и кустов
- CZ Akumulátorové nůžky na trávu a keře
- RO Trimmer cu acumulator pt. iarba si gard viu
- H Foarfecele cu acumulator pt. tăiat iarba
- E Tijeras a batería para hierba y arbustos

3.6 V 1.3 Ah Li-Ion

1000 min⁻¹

Li-Ion

80 mm

2in1

110 mm

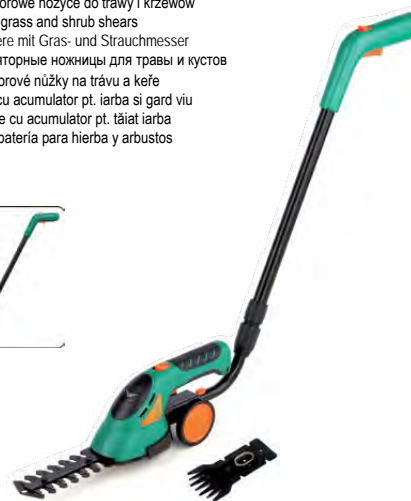

$L_{PA} = 74,6 \pm 3,0$ dB; $L_{WA} = 86,4 \pm 3,0$ dB; $a_n = 1,63 \pm 1,5$ m/s²

No.	V	min-1	☐
79501	3.6	1000	8

- PL Elektryczne nożyce do żywoplotu
 GB Hedge shears
 D Heckenscheren
 RUS Ножницы для живой изгороди
 CZ Nůžky na živý plot
 RO Foarfece pt. gard viu
 H Sövényvágó olló
 E Tijera para vallado

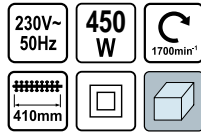

$L_{pA} = 81,6 \pm 3$ dB; $L_{wA} = 101,6 \pm 3$ dB; $a_n = 5,328 \pm 1,5 / 6,1214 \pm 1,5$ m/s²

No.	W	min-1	L (mm)	
79442	450	1700	410	4

- PL Nożyce do żywoplotu
 GB Hedge shears
 D Heckenscheren
 RUS Ножницы для живой изгороди
 CZ Nůžky na živý plot
 RO Foarfece pt. gard viu
 H Sövényvágó olló
 E Tijera para vallado



$L_{pA} = 78,58 \pm 1,489$ dB; $L_{wA} = 98,54 \pm 1,489$ dB; $a_n = 3,272 \pm 1,5 / 3,435 \pm 1,5$ m/s²

No.	W	min-1	L (mm)	
79448	550	1700	510	4

- PL Pilnik okrągły do łańcuchów
 GB Chain saw file
 D Runde Kettenfeile
 RUS Цилиндрический напильник для цепей
 CZ Kulatý pilník na řetězy
 RO Pilă rotundă pt. lanțuri
 H Láncvágó körfűrész
 E Lima redonda para cadenas



No.	L (mm)	chain pitch / podziałka łańcucha	Ø (mm)	pcs / packing	
79861	200	3/8 picco	4.0	3	200
79862	200	3/8; .325	4.5	3	200
79863	200	.325	4.8	3	200

- PL Klucz uniwersalny do narzędzi spalinowych
 GB Universal wrench for gasoline machines
 D Universalschlüssel für Benzin Maschinen
 RUS Универсальный ключ для бензинового инструмента
 CZ Univerzální klíč pro benzínové stroje
 RO Cheie universală pt. mașini pe benzină
 H Kulccsal benzín eszköz
 E Llave universal para máquinas de gasolina

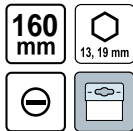

No.	
79869	10/100

- PL Nożyce do żywoplotu
 GB Hedge shears
 D Heckenscheren
 RUS Ножницы для живой изгороди
 CZ Nůžky na živý plot
 RO Foarfece pt. gard viu
 H Sövényvágó olló
 E Tijera para vallado

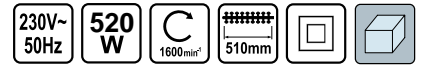

$L_{pA} = 75,2 \pm 0,6$ dB; $L_{wA} = 95,2 \pm 0,6$ dB; $a_n = 2,840 \pm 1,5$ m/s²

No.	W	min-1	L (mm)	
79444	520	1600	510	4

- PL Akumulator
 GB Battery
 D Akkumulator
 RUS Аккумулятор
 CZ Akumulátor
 RO Acumulatorul
 H Akkumulátor
 E Acumulador

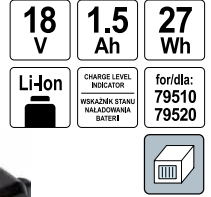

No.	V	for / dla	
79530	18	79510; 79520	25

- PL Prowadnik do pilnika do łańcuchów
 GB Guide for chain saw file
 D Führung für die Kettenfeile
 RUS Направляющая для напильника для цепей
 CZ Vedení pro pilník na řetězy
 RO Ghidaj pt. pila pt. lanțuri
 H Megvezető a láncfűrészhez
 E Guía de lima para cadenas



No.	chain pitch / podziałka łańcucha	Ø (mm)	
79865	3/8 picco	4.0	50/150
79866	3/8; .325	4.5	50/150
79867	.325	4.8	50/150

- PL Glowica żyłkowa
 GB Line head
 D Trimmerkopf
 RUS Головка с леской
 CZ Strunová hlava
 RO Cap cu cablu
 H Darnil fej
 E Cabezal de hilo

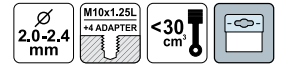

No.	Ø (mm)	
79550	2.0-2.4	10/40

PL Glowica żyłkowa
GB Line head
D Trimmerkopf
RUS Головка с леской
CZ Strunová hlava
RO Cap cu cablu
H Damil fej
E Cabezal de hilo

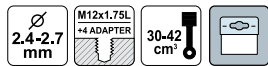

FLO

No.	Ø (mm)	
79551	2.4-2.7	10/40

PL Glowica żyłkowa
GB Line head
D Trimmerkopf
RUS Головка с леской
CZ Strunová hlava
RO Cap cu cablu
H Damil fej
E Cabezal de hilo



FLO

No.	Ø (mm)	for / dla	
79468	1.2	79467	20/100

PL Żyłka tnąca
GB Grass trimmer line
D Mähfaden
RUS Леска для триммера
CZ Struna do strunového sekačky
RO Furtun gradina
H Damil szegélynyíró géphez
E Hilo de cortar



FLO

No.	Ø (mm)	L (m)	profil	
89441	2.0	120	O	27
89442	2.4	90	O	27
89443	2.6	70	O	27
89444	3.0	56	O	27

PL Żyłka tnąca
GB Grass trimmer line
D Mähfaden
RUS Леска для триммера
CZ Struna do strunového sekačky
RO Furtun gradina
H Damil szegélynyíró géphez
E Hilo de cortar



FLO

No.	Ø (mm)	L (m)	profil	
89452	2.4	90	□	16
89453	2.6	70	□	16
89454	3.0	56	□	16

PL Glowica żyłkowa
GB Line head
D Trimmerkopf
RUS Головка с леской
CZ Strunová hlava
RO Cap cu cablu
H Damil fej
E Cabezal de hilo

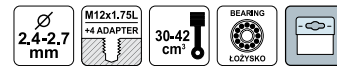

FLO

No.	Ø (mm)	
79552	2.4-2.7	10/40

PL Żyłka tnąca
GB Grass trimmer line
D Mähfaden
RUS Леска для триммера
CZ Struna do strunového sekačky
RO Furtun gradina
H Damil szegélynyíró géphez
E Hilo de cortar



FLO

No.	Ø (mm)	L (m)	profil	
89401	1.3	10	O	20/240
89402	1.6	10	O	20/240
89403	2.0	10	O	20/240
89404	2.4	10	O	12/144
89405	2.6	10	O	12/144
89406	3.0	10	O	12/144

PL Żyłka tnąca
GB Grass trimmer line
D Mähfaden
RUS Леска для триммера
CZ Struna do strunového sekačky
RO Furtun gradina
H Damil szegélynyíró géphez
E Hilo de cortar



FLO

No.	Ø (mm)	L (m)	profil	
89411	1.3	10	□	20/240
89412	1.6	10	□	20/240
89413	2.0	10	□	20/240
89414	2.4	10	□	12/144
89415	2.6	10	□	12/144
89416	3.0	10	□	12/144

PL Żyłka tnąca
GB Grass trimmer line
D Mähfaden
RUS Леска для триммера
CZ Struna do strunového sekačky
RO Furtun gradina
H Damil szegélynyíró géphez
E Hilo de cortar

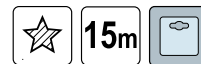

FLO

No.	Ø (mm)	L (m)	profil	
89421	1.3	15	☆	24/288
89422	1.6	15	☆	20/240
89423	2.0	15	☆	16/192
89424	2.4	15	☆	12/144
89425	2.6	15	☆	12/144
89426	3.0	15	☆	10/120

PL Żyłka tnąca
GB Grass trimmer line
D Mähfaden
RUS Леска для триммера
CZ Struna do strunové sekačky
RO Furtun gradina
H Damil szegélynyíró géphez
E Hilo de cortar



No.	Ø (mm)	L (m)	profil	
89456	2.0	90	☆	9/27
89457	2.4	90	☆	9/27
89458	2.6	90	☆	9/27
89459	3.0	60	☆	9/27

PL Żyłka tnąca
GB Grass trimmer line
D Mähfaden
RUS Леска для триммера
CZ Struna do strunové sekačky
RO Furtun gradina
H Damil szegélynyíró géphez
E Hilo de cortar

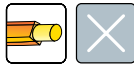

EXTRANYL

No.	Ø (mm)	L (m)	profil	
89465	2.4	90		10/20
89466	2.7	70		10/20
89467	3.0	60		10/20

PL Żyłka tnąca
GB Grass trimmer line
D Mähfaden
RUS Леска для триммера
CZ Struna do strunové sekačky
RO Furtun gradina
H Damil szegélynyíró géphez
E Hilo de cortar

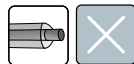

TRYGON

No.	Ø (mm)	L (m)	profil	
89473	2.4	90		10/20
89474	2.7	70		10/20
89475	3.0	60		10/20

PL Żyłka tnąca
GB Grass trimmer line
D Mähfaden
RUS Леска для триммера
CZ Struna do strunové sekačky
RO Furtun gradina
H Damil szegélynyíró géphez
E Hilo de cortar



SILENT

No.	Ø (mm)	L (m)	profil	
89483	2.0	90		10/20
89484	2.4	90		10/20
89485	2.7	70		10/20
89486	3.0	60		10/20

PL Żyłka tnąca
GB Grass trimmer line
D Mähfaden
RUS Леска для триммера

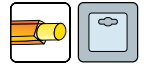

EXTRANYL

No.	Ø (mm)	L (m)	profil	
89462	2.4	15		10/120
89463	2.7	15		10/120
89464	3.0	12		10/120

PL Żyłka tnąca
GB Grass trimmer line
D Mähfaden
RUS Леска для триммера
CZ Struna do strunové sekačky
RO Furtun gradina
H Damil szegélynyíró géphez
E Hilo de cortar

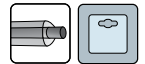

TRYGON

No.	Ø (mm)	L (m)	profil	
89470	2.4	15		10/120
89471	2.7	15		10/120
89472	3.0	12		10/120

PL Żyłka tnąca
GB Grass trimmer line
D Mähfaden
RUS Леска для триммера
CZ Struna do strunové sekačky
RO Furtun gradina
H Damil szegélynyíró géphez
E Hilo de cortar



SILENT

No.	Ø (mm)	L (m)	profil	
89478	1.6	15		20/240
89479	2.0	15		20/240
89480	2.4	15		10/120
89481	2.7	15		10/120
89482	3.0	12		10/120

PL Rękawice robocze
GB Working gloves
D Arbeitshandschuh
RUS Перчатки
CZ Pracovní rukavice
RO Mănuși
H Védőkesztyű
E Guantes



No.	
74100	12/300

PL Rękawice robocze
GB Working gloves
D Arbeitshandschuh
RUS Перчатки
CZ Pracovní rukavice
RO Mănuși
H Védőkesztyű
E Guantes



FLO

No.	pairs / pary	size / rozmiar	
74110	1	9	12/300

PL Rękawice robocze
GB Working gloves
D Arbeitshandschuh
RUS Перчатки
CZ Pracovní rukavice
RO Mănuși
H Védőkesztyű
E Guantes



FLO

No.	size / rozmiar	
74126	8	12/300
74132	9	12/300
74133	10	12/300

PL Rękawice robocze
GB Working gloves
D Arbeitshandschuh
RUS Перчатки
CZ Pracovní rukavice
RO Mănuși
H Védőkesztyű
E Guantes



FLO

No.	size / rozmiar	
74128	8	12/300
74136	9	12/300
74137	10	12/300

PL Rękawice ogrodnicze
GB Gardening gloves
D Arbeitshandschuh
RUS Перчатки



PL Rękawice robocze
GB Working gloves
D Arbeitshandschuh
RUS Перчатки
CZ Pracovní rukavice
RO Mănuși
H Védőkesztyű
E Guantes



FLO

No.	size / rozmiar	
74125	8	12/300
74130	9	12/300
74131	10	12/300

PL Rękawice robocze
GB Working gloves
D Arbeitshandschuh
RUS Перчатки
CZ Pracovní rukavice
RO Mănuși
H Védőkesztyű
E Guantes



FLO

No.	size / rozmiar	
74127	8	12/300
74134	9	12/300
74135	10	12/300

PL Rękawice ogrodnicze
GB Gardening gloves
D Arbeitshandschuh
RUS Перчатки



FLO

No.	size / rozmiar	
74117	8	50/1000

PL Rękawice ogrodnicze
GB Gardening gloves
D Arbeitshandschuh
RUS Перчатки



FLO

No.	size / rozmiar	
74123	8	50/1000

FLO

No.	size / rozmiar	
74121	8	50/1000

PL Rękawice ogrodnicze CZ Pracovní rukavice
GB Gardening gloves RO Mănuși
D Arbeitshandschuh H Védőkesztyű
RUS Перчатки E Guantes



No.	size / rozmiar	
74113	8	50/1000

PL Kalosze damskie CZ Dámské galoše
GB Women's rain boots RO Cizme damă
D Damen - Gummistiefel H Női gumicsizma
RUS Галоши женские E Chanclos para mujer

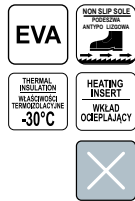

No.	size / rozmiar	model	
72831	36	LUNA	7
72832	37	LUNA	7
72833	38	LUNA	7
72834	39	LUNA	5
72835	40	LUNA	5
72836	41	LUNA	5

PL Kalosze męskie CZ Pánské galoše
GB Men's rain boots RO Cizme bărbați
D Herren - Gummistiefel H Férfi gumicsizma
RUS Галоши мужские E Chanclos para hombre



No.	size / rozmiar	model	
72881	40	FARMER	4
72882	41	FARMER	4
72883	42	FARMER	4
72884	43	FARMER	4
72885	44	FARMER	4
72886	45	FARMER	4
72887	46	FARMER	4
72888	47	FARMER	4

PL Rękawice ogrodnicze CZ Pracovní rukavice
GB Gardening gloves RO Mănuși
D Arbeitshandschuh H Védőkesztyű
RUS Перчатки E Guantes



No.	size / rozmiar	
74115	8	50/1000

PL Kalosze męskie CZ Pánské galoše
GB Men's rain boots RO Cizme bărbați
D Herren - Gummistiefel H Férfi gumicsizma
RUS Галоши мужские E Chanclos para hombre

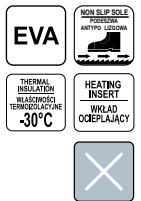

No.	size / rozmiar	model	
72840	41	PREDATOR XL	4
72841	42	PREDATOR XL	4
72842	43	PREDATOR XL	4
72843	44	PREDATOR XL	4
72844	45	PREDATOR XL	4
72845	46	PREDATOR XL	4
72846	47	PREDATOR XL	4

PL Kalosze damskie CZ Dámské galoše
GB Women's rain boots RO Cizme damă
D Damen - Gummistiefel H Női gumicsizma
RUS Галоши женские E Chanclos para mujer



No.	size / rozmiar	model	
72850	36	RAINY BLACK	10
72851	37	RAINY BLACK	10
72852	38	RAINY BLACK	10
72853	39	RAINY BLACK	10
72854	40	RAINY BLACK	10

- PL Kalosze męskie
GB Men's rain boots
D Herren - Gummistiefel
RUS Галоши мужские
- CZ Pánské galoše
RO Cizme bărbați
H Férfi gumicsizma
E Chanclos para hombre



demar

No.	size / rozmiar	model	
72858	41	GRAND BLACK	8
72859	42	GRAND BLACK	8
72860	43	GRAND BLACK	8
72861	44	GRAND BLACK	8
72862	45	GRAND BLACK	6
72863	46	GRAND BLACK	6
72864	47	GRAND BLACK	6

- PL Kalosze damskie
GB Women's rain boots
D Damen - Gummistiefel
RUS Галоши женские
- CZ Dámské galoše
RO Cizme damă
H Női gumicsizma
E Chanclos para mujer



VOREL

No.	size / rozmiar	
73931	36	7
73932	37	7
73933	38	7
73934	39	7
73935	40	7
73936	41	7

- PL Kalosze damskie
GB Women's rain boots
D Damen - Gummistiefel
RUS Галоши женские
- CZ Dámské galoše
RO Cizme damă
H Női gumicsizma
E Chanclos para mujer



VOREL

No.	size / rozmiar	
73945	37	5
73946	38	5
73947	39	5

- PL Buty gumowo - filcowe
GB Felt PVC boots
D Gummistiefel mit Filtz
RUS Сапоги резиновые с войлоком
- CZ Holinky s filcem
RO Cizme PVC
H Gumi - filc csizma
E Botas de goma fieltro



demar

No.	size / rozmiar	
72871	40	6
72872	41	6
72873	42	6
72874	43	6
72875	44	6
72876	45	6
72877	46	5

- PL Kalosze męskie
GB Men's rain boots
D Herren - Gummistiefel
RUS Галоши мужские
- CZ Pánské galoše
RO Cizme bărbați
H Férfi gumicsizma
E Chanclos para hombre



VOREL

No.	size / rozmiar	
73937	41	5
73938	42	5
73939	43	5
73940	44	5
73941	45	5
73942	46	5
73943	47	5

- PL Kalosze męskie
GB Men's rain boots
D Herren - Gummistiefel
RUS Галоши мужские
- CZ Pánské galoše
RO Cizme bărbați
H Férfi gumicsizma
E Chanclos para hombre



VOREL

No.	size / rozmiar	
73950	41	5
73951	42	5
73952	43	5
73953	44	5
73954	45	5
73955	46	5

- PL Buty gumowo-filcowe
 GB Felt PVC boots
 D Gummistiefel mit Filz
 RUS Сапоги резиновые с войлоком
- CZ Holinky s filcem
 RO Cizme PVC
 H Gumi - filc csizma
 E Botas de goma fieltro



No.	size / rozmiar	
73958	40	5
73959	41	5
73960	42	5
73961	43	5
73962	44	5
73963	45	5
73964	46	5

- PL Wielofunkcyjna podstawa gospodarcza
 GB All purpose boot tray
 D Garten- & Haushalt-Unterlage
 RUS Многофункциональный поднос
- CZ Multifunkční podložka
 RO Tava multifunctionala
 H Többfunkciós tálcá
 E Bandeja de arranque universal

780 x 384
x 32 mm

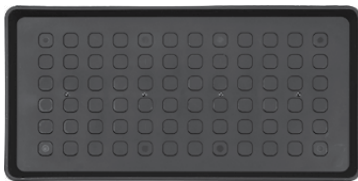

No.	mm	
67260	780x384x32	30

- PL Nakolanniki
 GB Knee pads
 D Kniegeschützer
 RUS Наколенники
- CZ Chrániče kolen
 RO Genunchiere
 H Térdvédő
 E Rodilleras



No.	
74610	20

- PL Nakolanniki
 GB Knee pads
 D Kniegeschützer
 RUS Наколенники
- CZ Chrániče kolen
 RO Genunchiere
 H Térdvédő
 E Rodilleras



No.	
74624	12/24

- PL Kalosze męskie
 GB Men's rain boots
 D Herren - Gummistiefel
 RUS Галоши мужские
- CZ Pánské galoše
 RO Cizme bărbăți
 H Férfi gumicsizma
 E Chanclos para hombre



No.	size / rozmiar	
73966	40	5
73967	41	5
73968	42	5
73969	43	5
73970	44	5
73971	45	5
73972	46	5
73973	47	5

- PL Nakolanniki
 GB Knee pads
 D Kniegeschützer
 RUS Наколенники
- CZ Chrániče kolen
 RO Genunchiere
 H Térdvédő
 E Rodilleras



No.	
74600	50

- PL Nakolanniki
 GB Knee pads
 D Kniegeschützer
 RUS Наколенники
- CZ Chrániče kolen
 RO Genunchiere
 H Térdvédő
 E Rodilleras



No.	
74622	50



PL Nakolanniki CZ Chrániče kolen
 GB Knee pads RO Genunchiere
 D Knieeschützer H Térdvédő
 RUS Наколенники E Rodilleras



No.	
74601	24

PL Nakolanniki CZ Chrániče kolen
 GB Knee pads RO Genunchiere
 D Knieeschützer H Térdvédő
 RUS Наколенники E Rodilleras



No.	
74603	6/24

PL Kask ochronny
 GB Safety helmet
 D Schutzhelm
 RUS Каска защитная
 CZ Ochranná přilba
 RO Cască de protecție
 H Védősisak
 E Casco de protección



No.	colour / kolor	
74190	○	40
74191	●	40
74192	●	40
74193	●	40
74194	●	40
74195	●	40

PL Przyłbica z osłoną wymienną i nausznikami przeciwhałasowymi
 GB Face shield with steel mesh and ear muff
 D Schweißerschutzhelm mit austauschbarer Abdeckung und Ohrenschilder gegen Lärm
 RUS Шлем с заменяемой защитой и наушниками против шума
 CZ Štít s vyměnitelným krytem a chrániči proti hluku
 RO Vizieră cu protecție schimbabilă și căști de protecție antizgomot
 H Arcvédő cserélhető pajzsral és fülvédő kagylóval
 E Antifaz con protección reemplazable y protectores de oídos



No.	
74462	40

PL Nakolanniki CZ Chrániče kolen
 GB Knee pads RO Genunchiere
 D Knieeschützer H Térdvédő
 RUS Наколенники E Rodilleras



No.	
74602	6/36

PL Nakolanniki - wkładki CZ Chrániče kolen
 GB Knee pads RO Genunchiere
 D Knieeschützer H Térdvédő
 RUS Наколенники E Rodilleras

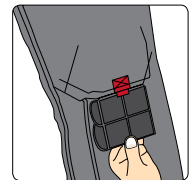

No.	
74595	60

PL Przyłbica z osłoną wymienną
 GB Face shield with PC visor
 D Schweißerschutzhelm mit austauschbarer Abdeckung
 RUS Шлем с заменяемой защитой
 CZ Štít s vyměnitelným krytem
 RO Vizieră cu protecție schimbabilă
 H Arcvédő cserélhető pajzsral
 E Antifaz con protección reemplazable

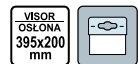

No.	
74461	40

PL Przyłbica z osłoną wymienną i nausznikami przeciwhałasowymi
 GB Face shield with steel mesh and ear muff
 D Schweißerschutzhelm mit austauschbarer Abdeckung und Ohrenschilder gegen Lärm
 RUS Шлем с заменяемой защитой и наушниками против шума
 CZ Štít s vyměnitelným krytem a chrániči proti hluku
 RO Vizieră cu protecție schimbabilă și căști de protecție antizgomot
 H Arcvédő cserélhető pajzsral és fülvédő kagylóval
 E Antifaz con protección reemplazable y protectores de oídos



PL Nauszniki przeciwhałasowe CZ Chrániče sluchu
 GB Ear muff RO Antifoane
 D Gehörschutz H Fülvédőt
 RUS Средства защиты слуха E Protectores de la vista

SNR
24 dB



No.		
74580		60

PL Okulary ochronne CZ Ochranné brýle
 GB Safety glasses RO Ochelari pt. protectie
 D Schutzbrille H Védőszemüveg
 RUS Очки защитные открытые E Gafas protectoras



No.	type	
74501	TVS	12/240

PL Okulary ochronne CZ Ochranné brýle
 GB Safety glasses RO Ochelari pt. protectie
 D Schutzbrille H Védőszemüveg
 RUS Очки защитные открытые E Gafas protectoras



No.	type	
74503	DY-8525	12/240

PL Okulary ochronne CZ Ochranné brýle
 GB Safety glasses RO Ochelari pt. protectie
 D Schutzbrille H Védőszemüveg
 RUS Очки защитные открытые E Gafas protectoras



No.	type	
74508	HF-103	10/120

PL Nauszniki przeciwhałasowe CZ Chrániče sluchu
 GB Ear muff RO Antifoane
 D Gehörschutz H Fülvédőt
 RUS Средства защиты слуха E Protectores de la vista



No.		
74581		10/60

PL Okulary ochronne CZ Ochranné brýle
 GB Safety glasses RO Ochelari pt. protectie
 D Schutzbrille H Védőszemüveg
 RUS Очки защитные открытые E Gafas protectoras



No.	type	
74502	HF-110	12/240

PL Okulary ochronne CZ Ochranné brýle
 GB Safety glasses RO Ochelari pt. protectie
 D Schutzbrille H Védőszemüveg
 RUS Очки защитные открытые E Gafas protectoras



No.	type	
74504	DY-8526	15/150

PL Okulary ochronne CZ Ochranné brýle
 GB Safety glasses RO Ochelari pt. protectie
 D Schutzbrille H Védőszemüveg
 RUS Очки защитные открытые E Gafas protectoras



No.	type	
74509	HF-105	10/100

- PL Obrzeże trawnikowe, zielone
GB Lawn edge
D Gartenumrandung
RUS Оградка для огорода
- CZ Plastový okraj trávníku
RO Gărduț plastic grădină
H Ágyásszegély
E Borde para jardín



FLO

No.	width / szerokość (mm)	L (m)	
88700	100	9	48
88701	150	9	36
88702	200	9	24

- PL Drut ogrodniczy
GB Twist tie
D Gartendraht
RUS Проволока огородная
- CZ Drát pro zahrádkáře
RO Sârmă pt. grădină
H Kötöződrót
E Alambre de jardinero



FLO

No.	L (m)	
88801	50	12/48

- PL Drut ogrodniczy w oslonie z pianki
GB Garden flexible tie
D Gartendraht, in einer Abdeckung aus Schaumstoff
RUS Проволока огородная покрытая пеной
CZ Drát pro zahrádkáře s pěnovým pláštěm
RO Sârmă pt. grădină cu izolație din spumă
H Kötöződrót, plasztik bevonattal
E Alambre de jardinero en cubierta de espuma



FLO

No.	L (m)	
88809	10	40

- PL Miernik ogrodniczy
GB Soil survey instrument
D Gartenmessgerät
RUS Измеритель огородный
CZ Zahradnický měřicí přístroj
RO Aparat de măsurat grădinăresc
H Négyfunkciós, kerti mérőműszer
E Medidor de horticultor

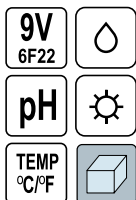

FLO

No.	L	
89000	10	10

- PL Obrzeże trawnikowe, brązowe
GB Lawn edge
D Gartenumrandung
RUS Оградка для огорода
- CZ Plastový okraj trávníku
RO Gărduț plastic grădină
H Ágyásszegély
E Borde para jardín



FLO

No.	width / szerokość (mm)	L (m)	
88703	100	9	48
88704	150	9	36
88705	200	9	24

- PL Drut ogrodniczy powlekany z obcinaczem
GB Twist tie with cutter
D Gartendraht, beschichtet, mit Abscheider
RUS Проволока огородная с диспенсером
CZ Drát pro zahrádkáře položený pláštěm s odfezavačem
RO Sârmă pt. grădină izolată cu tăietor
H Galvanizált kötöződrót, darabolóval
E Alambre de jardinero cubierto con tronizador



FLO

No.	L (m)	
88805	30	24/144
88806	50	24/144

- PL Zestaw ogrodniczy do podwiązania roślin
GB Plant binding set
D Gartensatz zum Abbinden von Pflanzen
RUS Набор огородный для подвязки растений
CZ Souprava pro zahrádkáře k vyvazování rostlin
RO Set pt. grădină pt. legare plante
H Kertészeti szett növények felkötéséhez
E Juego para jardín para sujetar plantas

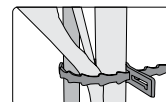
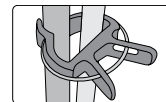

FLO

No.	pcs	
88811	71	24

- PL Kosz ogrodniczy
GB Garden basket
D Gartenkorb
RUS Корзина садовая
- CZ Zahradní koš
RO Coș de grădină
H Kerti kosár
E Cesta de jardín



FLO

No.	L	
35608	13	160

PL Kosz ogrodniczy
GB Garden basket
D Gartenkorb
RUS Корзина садовая
CZ Zahradní koš
RO Coș de grădină
H Kerti kosár
E Cesta de jardín



No.	l	☐
35610	25	480
35611	35	280

PL Wiadro ocynkowane
GB Galvanized bucket
D Baueimer
RUS Ведро
CZ Vědro
RO Găleată
H Kőműves vödör
E Cubo



No.	l	☐
89560	5	900
89561	7	450
89562	10	600
89563	12	500
89564	15	400

PL Worki ogrodowe
GB Garden bags
D Gartensäcke
RUS Мешки для огорода

CZ Zahradní pytle
RO Saci gunoi pt. gradina
H Kerti szemeteszák
E Bolsas de jardín



No.	l	pcs	μm	☐
09481	120	10	60	15

PL Worki perforowane na trawę
GB Waste bags for grass
D Gartenmüllsäcke perforiert
RUS Мусорные пакеты прочные для листьев

CZ Perforované odpadové pytle na trávu
RO Sac gunoi pt. iarba
H Szalagos kerti szemeteszák
E Sacos perforadas para residuos de jardín



No.	l	pcs	μm	☐
09483	120	10	35	25

PL Wiadro ogrodnicze
GB Garden bucket
D Garten Eimer
RUS Ведро огородное

CZ Zahradní vědro
RO Găleată de grădină
H Kerti vödör
E Cubo de jardín

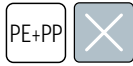

No.	l	☐
35600	15	500

PL Wiadro budowlane
GB Plastic bucket
D Baueimer
RUS Ведро строительное
CZ Stavební vědro
RO Găleată pt. construcții
H Kőműves vödör
E Cubo de obra



No.	l	☐
06388	10	900
06390	12	680
06393	16	450
06392	20	390

PL Worki ogrodowe z taśmą
GB Garden bags with cord
D Gartensäcke mit Band
RUS Мешки для огорода с лентой

CZ Zahradní pytle zatahovací
RO Saci gunoi pt. gradina cu strangere
H Szalagos kerti szemeteszák
E Bolsas de jardín con cinta



No.	l	pcs	μm	☐
09480	60	10	60	12
09482	120	10	60	15

PL Worki perforowane na liście
GB Perforated waste bags for leaves
D Gartenmüllsäcke perforiert
RUS Мусорные пакеты прочные для листьев

CZ Perforované odpadové pytle na listy
RO Szalagos kerti szemeteszák
H Sac gunoi perforat pt. frunze
E Sacos perforadas para residuos de jardín



No.	l	pcs	μm	☐
09484	200	10	40	12

PL Drabina wielofunkcyjna CZ Multifunkční žebřík
 GB Multifold ladder RO Scară multifuncțională
 D Mehrzweckleiter H Többcéjú létra
 RUS Многофункциональная стремянка E Escalera multipropósito

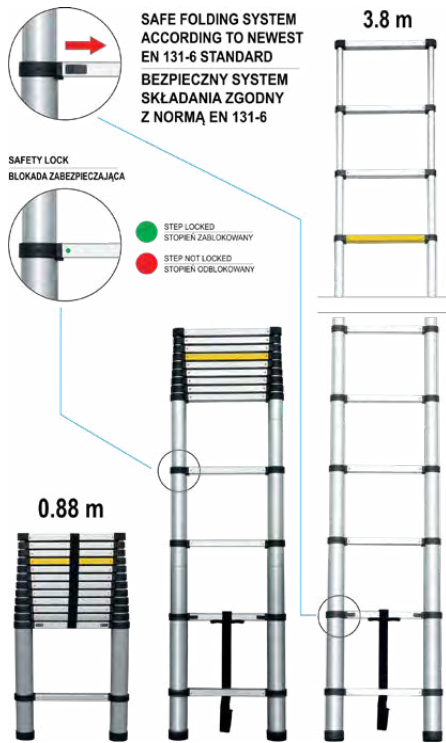

No.	height / wysokość (m)	number of steps / ilość stopni	
17701	3.8	13	1

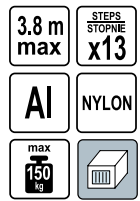

PL Aluminiowa drabina teleskopowa CZ Hliníkový teleskopický žebřík
 GB Aluminium telescopic ladder RO Scară telescopică din aluminiu
 D Teleskopleiter aus Aluminium H Aluminium kihúzható létra
 RUS Многофункциональная стремянка E Escalera telescópica de aluminio



No.	
17702	1

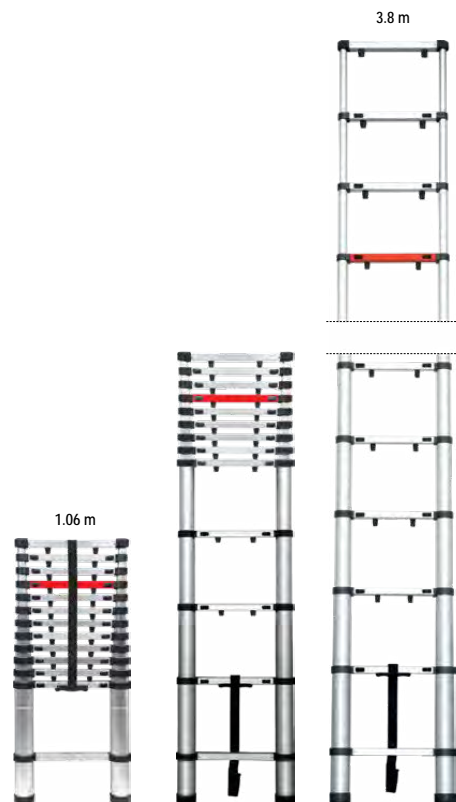

- PL Drabina wielofunkcyjna
- GB Multifold ladder
- D Mehrzweckleiter
- RUS Лестница многофункциональная
- CZ Multifunkční žebřík
- RO Scară multifuncțională
- H Többcélű létra
- E Escalera multipropósito

3.4 m max	STEPS STOPNIE 4x3	16 kg	max 150 kg	<input type="checkbox"/>
---------------------	---------------------------------------	-----------------	--------------------------------	--------------------------

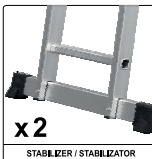
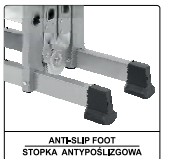
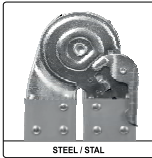
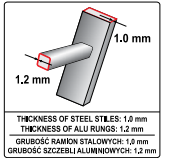
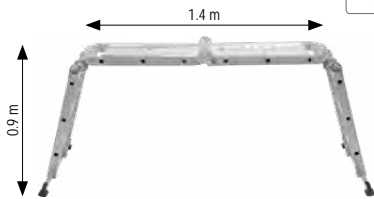

No.	height / wysokość (m)	number of steps / ilość stopni	<input type="checkbox"/>
17704	3.4	4x3	1

- PL Podest do drabiny wielofunkcyjnej
- GB Multifunction ladder platform
- D Podest für die Multifunktionale Leiter
- RUS Настил для лестницы трансформера
- CZ Plošina pro víceúčelový žebřík
- RO Platformă pt. scară multifuncțională
- H Palló a multifunkciós létrához
- E Descansillos para la escalera multifuncional

830x295 mm	560x295 mm
ZINC PLATED OCYNKOWANE	ANTI-SLIP SURFACE ANTYPOŚLIZGOWA POWERZWIĘZANA
max 150 kg	<input type="checkbox"/>

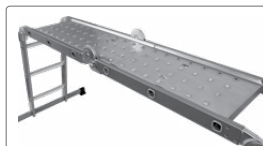
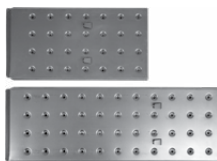

No.	for / dla	<input type="checkbox"/>
17705	17704	5

- PL Drabina 2-stopniowa rozkładana
- GB 2-step ladder
- D 2-Stufen-Leiter
- RUS 2-ступенчатая лестница
- CZ Schůdky 2 stupně
- RO Scări cu 2 trepte
- H 2 fokos lépcsők
- E 2 pasos escaleras

2 STEPS STOPNIE	90x47.5 x49 cm	99 cm FOLDED HIGH WYSOKOŚĆ ZŁOŻONEJ	38x26 cm STEP SIZE ROZMIAR STOPNIA
max 150 kg	ANTI-SLIP RUBBER PAD POŚLIZGADKA ANTY- POŚLIZGOWA	PROTECTION RAIL WSPORNIK OCHRONNY	SOFT GRIP MIEKKI UCHWYT



No.	height / wysokość (m)	number of steps / ilość stopni	<input type="checkbox"/>
17730	0.9	2	4

- PL Drabina 3-stopniowa rozkładana
- GB 3-step ladder
- D 3-Stufen-Leiter
- RUS 3-ступенчатая лестница
- CZ Schůdky 3 stupně
- RO Scări cu 3 trepte
- H 3 fokos lépcsők
- E 3 pasos escaleras

3 STEPS STOPNIE	115x47.5 x65 cm	125 cm FOLDED HIGH WYSOKOŚĆ ZŁOŻONEJ	38x26 cm STEP SIZE ROZMIAR STOPNIA
max 150 kg	ANTI-SLIP RUBBER PAD POŚLIZGADKA ANTY- POŚLIZGOWA	PROTECTION RAIL WSPORNIK OCHRONNY	SOFT GRIP MIEKKI UCHWYT



No.	height / wysokość (m)	number of steps / ilość stopni	<input type="checkbox"/>
17733	1.15	3	2

- PL Sito do kompostu i żwiru
- GB Compost and gravel sieve
- D Sieb für Kompost und Kies
- RUS Сито для компоста и гравия
- CZ Prohazovací síto na kompost a štěrk
- RO Cedazo para estiércol y guija
- H Sítá compost și zgură
- E Rosta komposztáláshoz és sóderhez



No.	cm	size of eyelet / rozmiar oczka (mm)	<input type="checkbox"/>
34949	60x100	20	5/30

PL Kompostownik
GB Composter
D Kompostierer
RUS Компостовник

CZ Kompostér
RO Compostor
H Komposztáló láda
E Compostador



No.	l	☐
35620	420	10

PL Kompostownik
GB Composter
D Kompostierer
RUS Компостовник

CZ Kompostér
RO Compostor
H Komposztáló láda
E Compostador



No.	l	☐
35622	880	6

PL Samochodowy prysznic turystyczny
GB Portable car shower set
D Campingdusche
RUS Портативный автомобиль душ

CZ Mobilní auto sprcha
RO Dus portabil masina
H Autós hordozható zuhany
E Portátil ducha de coche



FEATURES: / CECHY:
✓ Taking shower, washing car, washing dishes and others /
Prysznic, mycie samochodu, mycie naczyń i inne

No.	v	☐
82991	12	10

PL Kompostownik
GB Composter
D Kompostierer
RUS Компостовник

CZ Kompostér
RO Compostor
H Komposztáló láda
E Compostador



No.	l	☐
35621	650	7

PL Siatka zabezpieczająca rynny z uchwytyami mocującymi
GB Gutter mesh with hooks
D Schutzgitter für Rinnen mit Spannvorrichtungen
RUS Защитная сетка желоба с монтажными ручками
CZ Ochranná síť proti zanášení okapových žlabů s úchytkami
RO Plasă de protecție burlane cu suporturi de protecție
H Lombfógó háló rögzítő fűlekkel
E Malla de protección para la canaleta con mandriles de sujeción



No.	☐
69851	30

PL Samochodowy prysznic turystyczny
GB Portable car shower set
D Campingdusche
RUS Портативный автомобиль душ

CZ Mobilní auto sprcha
RO Dus portabil masina
H Autós hordozható zuhany
E Portátil ducha de coche

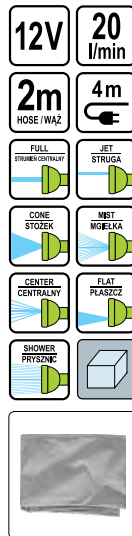

FEATURES: / CECHY:
✓ Taking shower, washing car, washing dishes, watering plants and others /
Prysznic, mycie samochodu, mycie naczyń, podlewanie roślin i inne

No.	v	☐
82992	12	10

- PL Przedłużacz CZ Prodlužovací kabel zahradní
 GB Garden extension cable RO Prelungitor electric
 D Gartenverlängerungskabel H Kerti hosszabbító
 RUS Электродлинитель E Cable de extensión para jardín

230V~50Hz IP20
 2x1.0mm²



No.	L (m)	☐
82671	10	10
82673	20	10
82675	30	5

- PL Grill gazowy CZ Plynový gril
 GB Gas BBQ grill RO Grătarul cu gaz
 D Der Gasgrill H Gázgrill
 RUS Газовый гриль E Barbacoa de gas

16 kW



LUND

No.	☐
99643	1

- PL Grill gazowy CZ Plynový gril
 GB Gas BBQ grill RO Grătarul cu gaz
 D Der Gasgrill H Gázgrill
 RUS Газовый гриль E Barbacoa de gas

12.8 kW



LUND

No.	☐
99642	1

- PL Reduktor z węzłem CZ Regulátor plynu a hadice
 GB Gas regulator and hose RO Furtun pt. gaz cu regulator
 D Schlauch und Regler H Nyomásszabályozó szett
 RUS Газовый шланг с редуктором E Regulador de gas con manguera

37 mbar



VOREL

No.	L (m)	☐
99670	1.0	16
99671	1.5	16

- PL Grill węglowy z termometrem
 GB Charcoal BBQ grill
 D Holzkohlegrill
 RUS Гриль-барбекю угольный
- CZ Gril na dřevěné uhlí
 RO Gratar carbuni
 H Faszén grill
 E Barbacoa de carbón y lena



CHIMNEY / KOMIN



ASHPAN / POIELNIK



GRILL SIZE / ROZMIAR RUSZTU
64 x 37 cm



FIREBOWL HEIGHT 85.5 cm
WYSOKOSC PALENIKA 85.5 cm



SMOKER / WĘDZARNIA



THERMO GAUGE / TERMOMETR



AIR FLOW / OBIEG POWIETRZA

LUND

No.
99587



1

- PL Grill węglowy z termometrem
 GB Charcoal BBQ grill
 D Holzkohlegrill
 RUS Гриль-барбекю угольный
- CZ Gril na dřevěné uhlí
 RO Gratar carbuni
 H Faszén grill
 E Barbacoa de carbón y lena



FOLDING SHELF / SKŁADANA PÓLKA



ASHPAN / POIELNIK



GRILL SIZE / ROZMIAR RUSZTU
57 x 37 cm



FIREBOWL HEIGHT 85 cm
WYSOKOSC PALENIKA 85 cm



GRILL ADJUSTMENT SYSTEM
SYSTEM REGULACJI RUSZTU



THERMO GAUGE / TERMOMETR



AIR FLOW / OBIEG POWIETRZA

LUND

No.
99588



1

- PL Grill ogrodowy z termometrem i wędzarnią
 GB Big barrel BBQ with smoker
 D BBQ Grillwagen mit Temperaturanzeige und Räucherei
 RUS Барбекю-коптильня с термометром
 CZ Zahradní udírna s grilem
 RO Grătar cu afumătoare si termometru
 H Kültéri faszénes grill
 E Barbacoa Grill de carbón con soporte



GRILL SIZE / ROZMIAR RUSZTU
60 x 30 cm



THERMO GAUGE
TERMOMETR



SMOKER / WĘDZARNIA



AIR FLOW / OBIEG POWIETRZA



LUND

No.
99513



1

- PL Grill ogrodowy z termometrem
 GB Big barrel BBQ with thermo gauge
 D BBQ Grillwagen XXL mit Temperaturanzeige
 RUS Барбекю-коптильня с термометром
- CZ Zahradní udírna s grilem
 RO Grătar cu afumătoare si termometru
 H Kültéri faszénes grill
 E Barbacoa Grill de carbón con soporte



AIR FLOW / OBIEG POWIETRZA



GRILL SIZE / ROZMIAR RUSZTU
71 x 35 cm



METAL FIREPLACE / PLYTA ŻAROODPORNĄ



THERMO GAUGE / TERMOMETR



CHARCOAL BBQ GRILL
GRILL WĘGLOWY



ASHPAN / POIELNIK

LUND

No.
99512



1

- PL Grill węglowy z termometrem
 GB Charcoal BBQ grill
 D Holzkohlegrill
 RUS Гриль-барбекю угольный
- CZ Gril na dřevěné uhlí
 RO Gratar carbuni
 H Faszén grill
 E Barbacoa de carbón y lena



ASHPAN / POPIELNIK



GRILL SIZE / ROZMIAR RUSZTU
71 x 34,5 cm



FIREBOWL HEIGHT 75 cm
WYSOKOŚĆ PALENISKA 75 cm



2 WOODEN SHELVES
2 DREWNIANE POŁKI



THERMO GAUGE / TERMOMETR



AIR FLOW / OBIEG POWIETRZA

LUND

No.

99586



1

- PL Grill ogrodowy z termometrem
 GB Big barrel BBQ with thermo gauge
 D BBO Grillwagen XXL mit Temperaturanzeige
 RUS Барбекю-коптильня с термометром
 CZ Zahradní udlina s grilem
 RO Gratar cu afumătoare si termometru
 H Kültéri faszénes grill
 E Barbacoa Grill de carbón con soporte



GRILL SIZE /
ROZMIAR RUSZTU
47 x 34 cm



THERMO GAUGE
TERMOMETR



AIR FLOW /
OBIEG POWIETRZA



LUND

No.

99514



1

- PL Grill węglowy
 GB Charcoal BBQ grill
 D Holzkohlegrill
 RUS Гриль-барбекю угольный
 CZ Gril na dřevěné uhlí
 RO Gratar carbuni
 H Faszén grill
 E Barbacoa de carbón y lena



CHARCOAL BBQ GRILL
GRILL WĘGLOWY



GRILL SIZE / ROZMIAR RUSZTU
72 x 39 cm



2 ADJUSTABLE GRILLS
2 REGULOWANE RUSZTY



LUND

No.

99519



1

- PL Grill węglowy
 GB Charcoal BBQ grill
 D Holzkohlegrill
 RUS Гриль-барбекю угольный
 CZ Gril na dřevěné uhlí
 RO Gratar carbuni
 H Faszén grill
 E Barbacoa de carbón y lena



CHARCOAL BBQ GRILL
GRILL WĘGLOWY



GRILL SIZE / ROZMIAR RUSZTU
ø56.5 cm



THERMO GAUGE / TERMOMETR



ASH OUTLET / POPIELNIK



AIR FLOW / OBIEG POWIETRZA



LUND

No.

99584



1

- PL Grill węglowy
- GB Charcoal BBQ grill
- D Holzkohlegrill
- RUS Гриль-барбекю угольный
- CZ Gril na dřevěné uhlí
- RO Gratar carbuni
- H Faszén grill
- E Barbacoa de carbón y lena



LUND

No.
99580



1

- PL Grill węglowy
- GB Charcoal BBQ grill
- D Holzkohlegrill
- RUS Гриль-барбекю угольный
- CZ Gril na dřevěné uhlí
- RO Gratar carbuni
- H Faszén grill
- E Barbacoa de carbón y lena



LUND

No.
99582



1

- PL Grill węglowy
- GB Charcoal BBQ grill
- D Holzkohlegrill
- RUS Гриль-барбекю угольный

- CZ Gril na dřevěné uhlí
- RO Gratar carbuni
- H Faszén grill
- E Barbacoa de carbón y lena

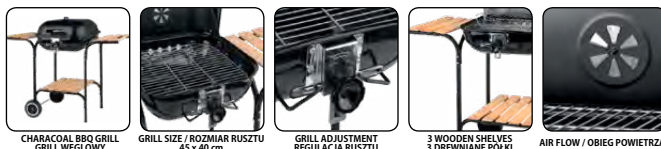

LUND

No.
99581



1

- PL Grill węglowy
- GB Charcoal BBQ grill
- D Holzkohlegrill
- RUS Гриль-барбекю угольный

- CZ Gril na dřevěné uhlí
- RO Gratar carbuni
- H Faszén grill
- E Barbacoa de carbón y lena

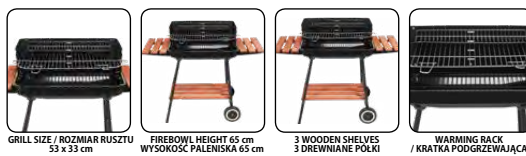

LUND

No.
99589



1

PL Grill węglowy z półką
GB Charcoal BBQ grill
D Holzkohlegrill
RUS Гриль-барбекю угольный

CZ Gril na dřevěné uhlí
RO Gratar carbuni
H Faszén grill
E Barbacoa de carbón y lena



GRILL SIZE / ROZMIAR RUSZTU
48 x 28 cm

FIREBOWL HEIGHT 69.5 cm
WYSOKOŚĆ PALENIŚKA 69.5 cm

2 WOODEN SHELVES
2 DREWNIANE PÓLKI

WOODEN HANDLES
DREWNIANA RĄCZKA

LUND

No.

99585



1

PL Grill węglowy
GB Charcoal BBQ grill
D Holzkohlegrill
RUS Гриль-барбекю угольный
CZ Gril na dřevěné uhlí
RO Gratar carbuni
H Faszén grill
E Barbacoa de carbón y lena



FIRE BOWL HIGH / WYSOKOŚĆ
PALENIŚKA 59 cm

GRILL SIZE /
ROZMIAR RUSZTU Ø 41 cm

ASHPAN / POPIELNIK

AIR FLOW / OBIEG POWIETRZA

RAIN COVER / POKROWIEC
PRZECIWDESZCZOWY

LUND

No.

99583



1

PL Grill węglowy
GB Charcoal BBQ grill
D Holzkohlegrill
RUS Гриль-барбекю угольный

CZ Gril na dřevěné uhlí
RO Gratar carbuni
H Faszén grill
E Barbacoa de carbón y lena

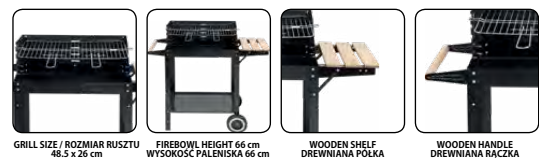

GRILL SIZE / ROZMIAR RUSZTU
48.5 x 26 cm

FIREBOWL HEIGHT 66 cm
WYSOKOŚĆ PALENIŚKA 66 cm

WOODEN SHELF
DREWNIANA PÓLKA

WOODEN HANDLE
DREWNIANA RĄCZKA

LUND

No.

99592



1

PL Grill węglowy z pokrywą
GB Charcoal BBQ grill
D Holzkohlegrill
RUS Гриль-барбекю угольный

CZ Gril na dřevěné uhlí
RO Gratar carbuni
H Faszén grill
E Barbacoa de carbón y lena



GRILL SIZE / ROZMIAR RUSZTU
Ø 41 cm

FIREBOWL HEIGHT 59 cm
WYSOKOŚĆ PALENIŚKA 59 cm

AIR FLOW / OBIEG POWIETRZA

ASHPAN / POPIELNIK

LUND

No.

99591



1

- PL Grill węglowy składany CZ Přenosný gril
 GB Folding charcoal grill RO Gratar portabil
 D Holzkohle-Faltgrill H Hordozható faszenes grill
 RUS Барбекю складной E Parrilla portátil



GRILL SIZE /
ROZMIAR RUSZTU 42x22 cm



AIR FLOW /
OBIEG POWIETRZA



FOLDING SIZE /
WYMIAR PO ZŁOŻENIU 43x23x5 cm

LUND

No.	1
99593	1

- PL Wędzarnia CZ Udírna
 GB Smoker RO Afumător
 D Raucherei H Füstölővel
 RUS Коптильня E Ahumador



46x41,5x77
cm

x3
HANDLES
UCHWYTY

x3
LEGS
NÓŻKI



x2
CERAMIC BOWL / PORCELA-
NOWA MISA



x2
COOKING GRILL / RUSZT

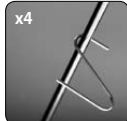

x4
HANGERS / HACZYKI



THERMO GAUGE / TERMOMETR



AIR FLOW /
OBIEG POWIETRZA

LUND

No.	1
99633	1

- PL Palenisko ogrodowe CZ Zahradní ohniště
 GB Fire pit RO Gratar tip vatra
 D Gartenfeuerstätte H Kerti tűzrakó
 RUS Садовый очаг E Fogón para jardín



56x39
cm

x3
LEGS
NÓŻKI

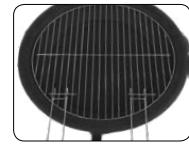

COOKING GRILL / RUSZT



FOLDING LEGS / SKŁADANE NÓŻKI

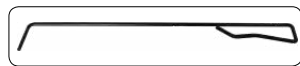

STEEL POKER / STALOWY POGRZEBACZ

LUND

No.	1
99701	1

- PL Grill wiszący na trójnożu
 GB Round chain grill
 D Dreibockhängegrill
 RUS Подвесной гриль на треноге
 CZ Závěsný gril na trojnožce
 RO Gratar pe lant / trepid
 H Állványos függő grill
 E Parrilla colgante con trípode



70x152
x70 cm

30-67 cm
COOKING HEIGHT
REGULOWANA
WYSOKOŚĆ RUSZTU

52 cm
BOWL / MISA



LUND

No.	1
99524	1

- PL Palenisko ogrodowe CZ Zahradní ohniště
 GB Fire pit RO Gratar tip vatra
 D Gartenfeuerstätte H Kerti tűzrakó
 RUS Садовый очаг E Fogón para jardín

52x52x28
cm

x4
LEGS
NÓŻKI



STEEL POKER / STALOWY POGRZEBACZ

LUND

No.	1
99700	1

- PL Palenisko ogrodowe CZ Zahradní ohniště
 GB Fire pit RO Gratar tip vatra
 D Gartenfeuerstätte H Kerti tűzrakó
 RUS Садовый очаг E Fogón para jardín

42x53
cm

x4
LEGS
NÓŻKI

x2
HANDLES
UCHWYTY

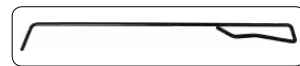

STEEL POKER / STALOWY POGRZEBACZ

LUND

No.	1
99702	1

PL Palenisko ogrodowe CZ Zahradní ohniště
 GB Fire pit RO Gratar tip vatra
 D Gartenfeuerstätte H Kerti tűzrakó
 RUS Садовый очаг E Fogón para jardín



COOKING GRILL / RUSZT

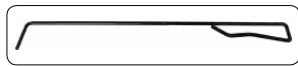

STEEL POKER / STALOWY POGRZEBACZ

LUND

No.		
99703	1	

PL Palenisko ogrodowe CZ Zahradní ohniště
 GB Cast iron fire pit RO Gratar tip vatra
 D Gartenfeuerstätte H Kerti tűzrakó
 RUS Садовый очаг E Fogón para jardín



LUND

No.		
99711	1	

PL Fartuch do grillowania GB BBQ apron
 D Grillschürze
 RUS Фартук для барбекю
 CZ Grilovací zástěra
 RO Gratar șort
 H Grill kötény
 E Delantal de la parrilla



No.		
99782	60	

PL Palenisko ogrodowe CZ Zahradní ohniště
 GB Cast iron fire pit RO Gratar tip vatra
 D Gartenfeuerstätte H Kerti tűzrakó
 RUS Садовый очаг E Fogón para jardín



LUND

No.		
99710	1	

PL Pokrowiec na grilla CZ Obal na gril
 GB BBQ cover RO Gratar acoperă
 D Wetterschutzhaube H Grill takaróponyva
 RUS Обложка гриля E Cubierta de barbacoa

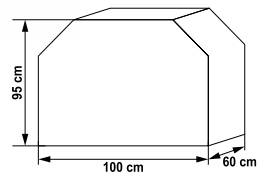
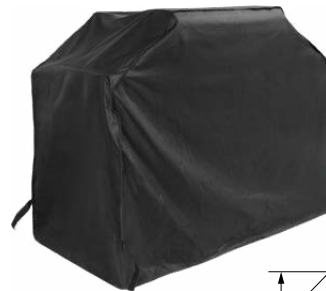

LUND

No.	size / rozmiar (mm)	for / dla	
99760	100x60x95	99512; 99514; 99519; 99586; 99588	20

PL Fartuch do grillowania z akcesoriami GB BBQ apron with accessories
 D Grillschürze
 RUS Фартук для барбекю
 CZ Grilovací zástěra
 RO Gratar șort
 H Grill kötény
 E Delantal de la parrilla



No.		
99783	8/16	

PL Widelec ogniskowy CZ Videlka na opékání
 GB Rake handle RO Furculita / tepusa
 D Lagerfeuerspies H Grillvilla
 RUS Шампур-вилка для гриля E Tenedor de fuego



No.	L (cm)	
99568	98	10/100

PL Widelec ogniskowy CZ Videlka na opékání
 GB Rake handle RO Furculita / tepusa
 D Lagerfeuerspies H Grillvilla
 RUS Шампур-вилка для гриля E Tenedor de fuego

No.	L (cm)	
99576	120	60

PL Widelec ogniskowy CZ Videlka na opékání
 GB Rake handle RO Furculita / tepusa
 D Lagerfeuerspies H Grillvilla
 RUS Шампур-вилка для гриля E Tenedor de fuego



No.	L (cm)	
99575	120	60

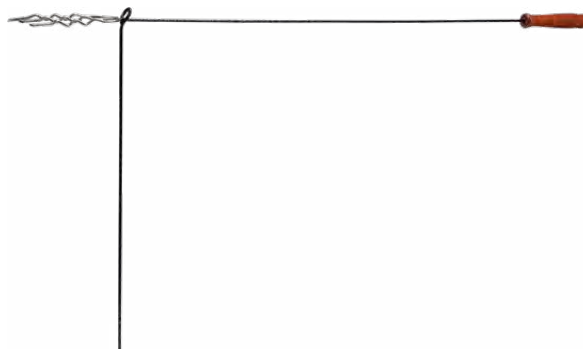

24	Memo
----	------

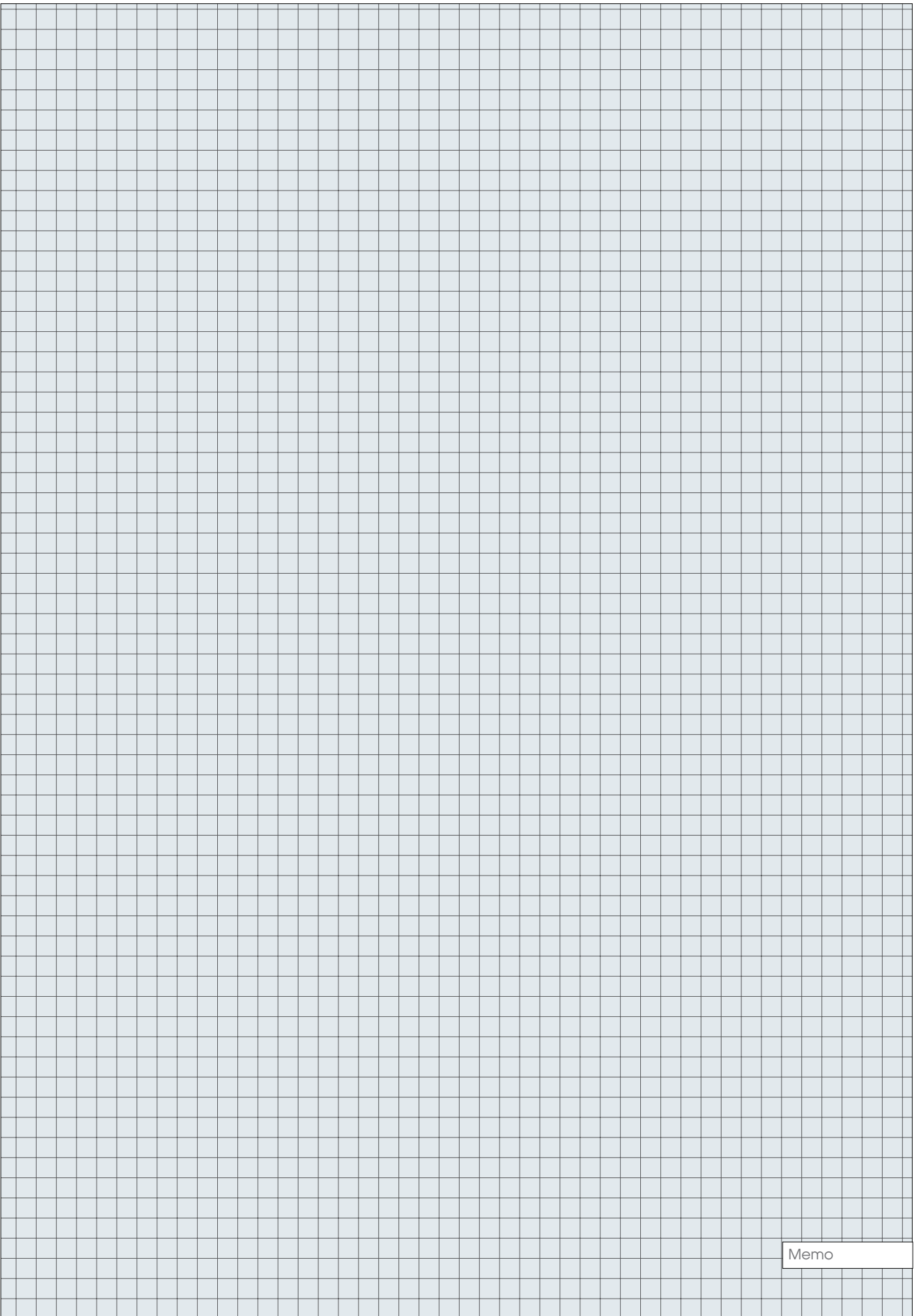

Memo

25

Sanitary ware & hydraulics
Armatura sanitarna i hydraulika

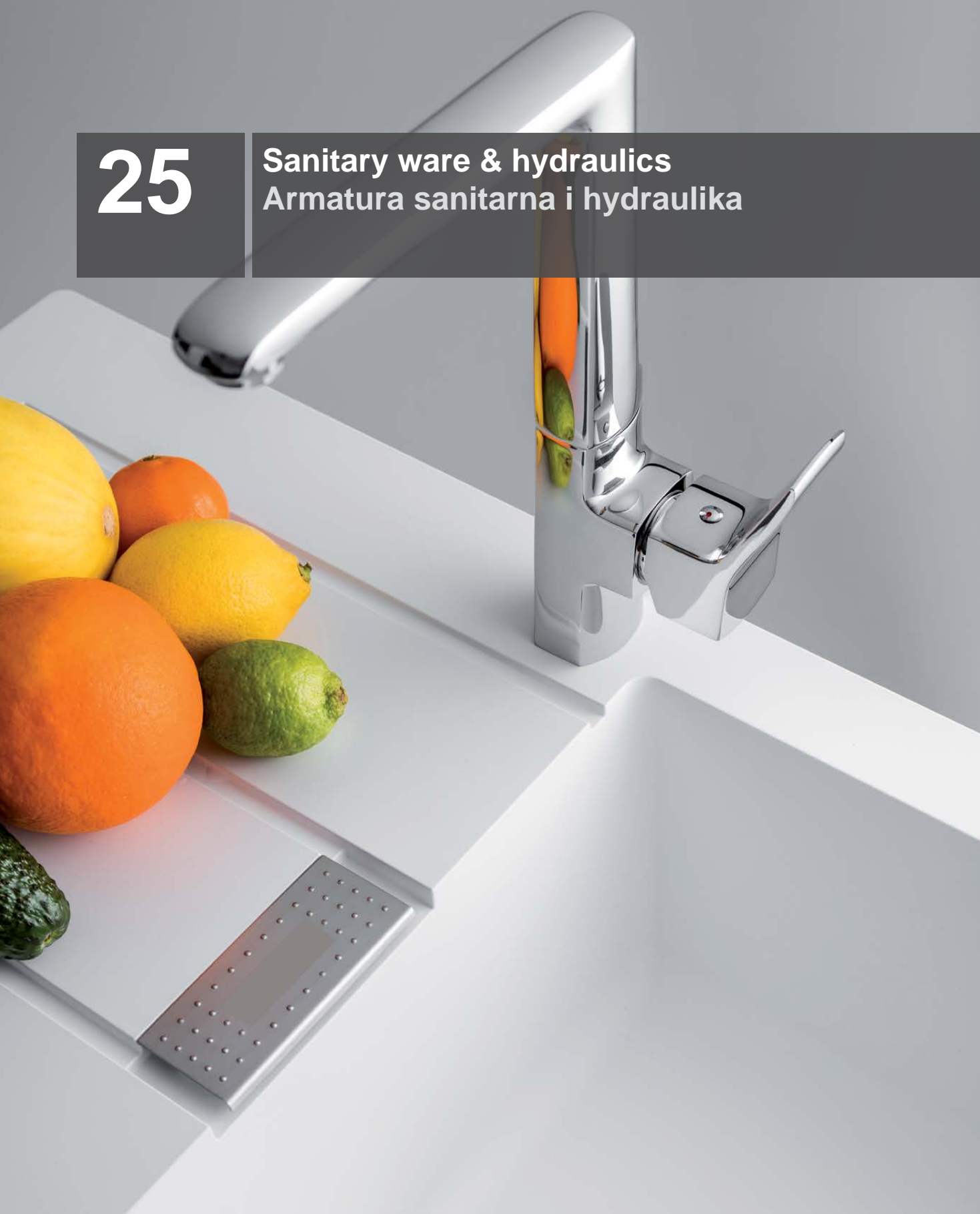

Mixers, faucets
Baterie

.....454-468

**Linear drains**
Odpływy liniowe

.....469-471

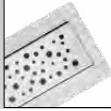
**Pop-up wastes**
Korki automatyczne

.....471

**Shower handles**
Słuchawki prysznicowe

.....471-476

**Shower & connecting hoses**
Wężę prysznicowe i przyłączeniowe

.....476-478

**Bathroom & shower sets**
Komplety łazienkowe i prysznicowe

.....479-481

**Bathroom accessories**
Akcesoria łazienkowe

.....481-489

**Toilet seats**
Deski toaletowe

.....489-490

**Bathroom ceramic**
Ceramika łazienkowa

.....490-491

**Bathroom scales**
Wagi łazienkowe

.....492-493

**Plastic stools**
Stołki plastikowe

.....493

**Hydraulic accessories**
Akcesoria hydrauliczne

.....493-496



<p>The exclusive composition with sapphire hardness developed by famous spanish company.</p> <p>Głowica z wkładem ceramicznym o twardości szafiru renomowanego hiszpańskiego producenta.</p>  <p>CORUNDOx</p>	<p>Mixing water flow with intake air reduces consumption by half, without splashing.</p> <p>Zmieszany strumień wody z zasysanym powietrzem oszczędza zużycie o połowę i nie chlapie.</p>  <p>ECOflow</p>	<p>The most effective way to save water and energy - flowing only cold water when the lever is centered.</p> <p>Najefektywniejszy sposób oszczędzania wody i energii - dla uchwytu usytuowanego na wprost poplynie tylko zimna woda.</p>  <p>ECOstart</p>
<p>Nano-size cavities on the disc surface to keep the lubrication, provides a higher durability and an improved smooth feeling.</p> <p>Mikroząglębienia dzięki którym smar w głowicy nie wypłykuje się i głowica działa gładko przez wiele lat.</p>  <p>NANOCave</p>	<p>Rubbing the lime away with a finger and the stream is like in brand new faucet again.</p> <p>Przetarcie palcem usuwa kamień i przywraca strumień jak w nowej baterii.</p>  <p>SMARTclean</p>	<p>Reduced noise thanks to silencer in eccentric wall connector.</p> <p>Obniżony hałas dzięki użyciu tłumików w złączach.</p>  <p>LOWnoise</p>
<p>Ergonomic faucet provides more space for comfortable using.</p> <p>Ergonomiczna bateria zapewniająca przestrzeń dla wygodnego użytkowania.</p>  <p>ERGOsize</p>	<p>Simple and effective installation thanks to the large nut that screw without any tools.</p> <p>Łatwy i trwały montaż dzięki dużej nakrętce, którą przykręcisz bez użycia jakiegokolwiek narzędzi.</p>  <p>SMARTnut</p>	<p>Improved lime protection: integrated honeycomb structure replaces conventional wire mesh screens prone to lime build-up.</p> <p>Lepsza ochrona przeciwkapienna: struktura plastra miodu zastępuje klasyczne wkłady siateczkowe, które mają tendencję do zarastania.</p>  <p>HEXAGONal</p>
<p>Body without holes and nooks that could accumulate dirt and microorganisms.</p> <p>Korpus bez otworów i zakamarków, które gromadzą brud i mikroorganizmy.</p>  <p>CLEANbody</p>	<p>Innovative mounting system for hose nut and safe servicing aerator.</p> <p>Innowacyjny system montażu wężyków i bezpiecznego serwisowania aeratora.</p>  <p>SMARTtool</p>	<p>Multi-purpose hydraulic wrench for installation of faucet and small plumbing work.</p> <p>Wielofunkcyjny klucz hydrauliczny do montażu baterii i drobnych prac hydraulicznych.</p>  <p>SMARTtool</p>
<p>High quality stainless steel is characterized by increased resistance to chemicals, preserving its appearance even after many years of use.</p> <p>Wysokiej jakości stal nierdzewna charakteryzuje się zwiększoną odpornością na chemikalia, zachowując swój wygląd nawet po wielu latach użytkowania.</p>  <p>Sus304</p>	<p>Stainless steel is free of zinc and lead - toxic elements, which in micro quantities get into the water in brass faucets.</p> <p>Stal nierdzewna jest wolna od cynku i ołowiu - toksycznych pierwiastków, które w mikro ilościach dostają się do wody w mosiężnych kranach.</p>  <p>NOlead</p>	<p>All parts are made of stainless steel, so they are rust-resistant.</p> <p>Wszystkie części wykonane są ze stali nierdzewnej i są odporne na rdzę.</p>  <p>FULL steel</p>

- PL Bateria umywalkowa
- GB Basin mixer
- D Einhand-Waschtischbatterie
- RUS Смеситель для раковины
- CZ Umyvadlová baterie
- RO Bateria lavoar
- H Mosdó csaptelep
- E Monomando de lavabo



FALA

No.	series / seria	
75801	STEELY 1	20

- PL Bateria umywalkowa
- GB Basin mixer
- D Einhand-Waschtischbatterie
- RUS Смеситель для раковины
- CZ Umyvadlová baterie
- RO Bateria lavoar
- H Mosdó csaptelep
- E Monomando de lavabo



FALA

No.	series / seria	
75803	STEELY 3	10

- PL Bateria umywalkowa
- GB Basin mixer
- D Einhand-Waschtischbatterie
- RUS Смеситель для раковины
- CZ Umyvadlová baterie
- RO Bateria lavoar
- H Mosdó csaptelep
- E Monomando de lavabo



FALA

No.	series / seria	
75802	STEELY 2	12

- PL Bateria umywalkowa
- GB Basin mixer
- D Einhand-Waschtischbatterie
- RUS Смеситель для раковины
- CZ Umyvadlová baterie
- RO Bateria lavoar
- H Mosdó csaptelep
- E Monomando de lavabo



FALA

No.	series / seria	
75804	STEELY 4	10

PL Kolumna prysznicowa
GB Shower column
D Duschsäule
RUS Душевая штанга
CZ Sprchový sloup
RO Coloană de duș
H Zuhanyoszlop
E Columna de ducha



FALA

No.	series / seria	
75662	STEELY 1	5

PL Kolumna prysznicowa
GB Shower column
D Duschsäule
RUS Душевая штанга
CZ Sprchový sloup
RO Coloană de duș
H Zuhanyoszlop
E Columna de ducha



FALA

No.	series / seria	
75663	STEELY 2	5

PL Kolumna prysznicowa
GB Shower column
D Duschsäule
RUS Душевая штанга
CZ Sprchový sloup
RO Coloană de duș
H Zuhanyoszlop
E Columna de ducha



FALA

No.	series / seria	
75664	STEELY 3	5

PL Kolumna prysznicowa
GB Shower column
D Duschsäule
RUS Душевая штанга
CZ Sprchový sloup
RO Coloană de duș
H Zuhanyoszlop
E Columna de ducha



FALA

No.	series / seria	
75665	STEELY 4	5

PL Bateria zlewozmywakowa
GB Single-lever sink mixer
D Einhand-Spültischbatterie
RUS Смеситель для кухни
CZ Dřezová baterie
RO Baterie stativă bucatărie
H Mosogató csaptelep
E Monomando de fregadero



FALA

No.	series / seria	
75716	STEELY 1	10

PL Bateria zlewozmywakowa
GB Single-lever sink mixer
D Einhand-Spültischbatterie
RUS Смеситель для кухни
CZ Dřezová baterie
RO Baterie stativă bucatărie
H Mosogató csaptelep
E Monomando de fregadero

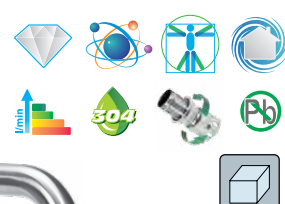

FALA

No.	series / seria	
75718	STEELY 2	10

- PL Bateria zlewozmywakowa
- GB Single-lever sink mixer
- D Einhand-Spültischbatterie
- RUS Смеситель для кухни
- CZ Dřezová baterie
- RO Baterie stativă bucătărie
- H Mosogató csaptelep
- E Monomando de fregadero



FALA

No.	series / seria	box
75719	STEELY 3	10

- PL Bateria zlewozmywakowa
- GB Single-lever sink mixer
- D Einhand-Spültischbatterie
- RUS Смеситель для кухни
- CZ Dřezová baterie
- RO Baterie stativă bucătărie
- H Mosogató csaptelep
- E Monomando de fregadero



FALA

No.	series / seria	box
75806	STEELY 5	5

- PL Podtynkowy system prysznicowy
- GB Built-in shower system
- D Unterputz-duschsystem
- RUS Душевой гарнитур скрытого монтажа
- CZ Sprchový podomítkový set
- RO Set de dus incastat baterie
- H Falsik alatti zuhanyzett
- E Sistema dual de ducha empotrado

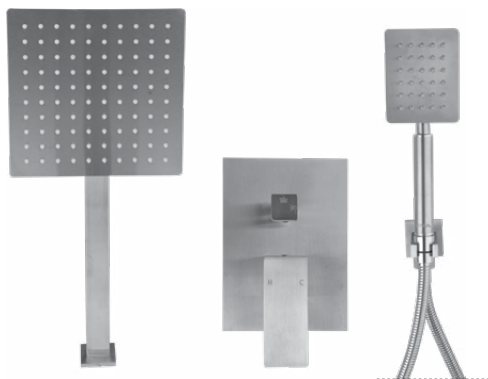

FALA

No.	series / seria	box
75871	STEELY S	4

- PL Bateria zlewozmywakowa
- GB Single-lever sink mixer
- D Einhand-Spültischbatterie
- RUS Смеситель для кухни
- CZ Dřezová baterie
- RO Baterie stativă bucătărie
- H Mosogató csaptelep
- E Monomando de fregadero



FALA

No.	series / seria	box
75805	STEELY 4	5

- PL Podtynkowy system prysznicowy
- GB Built-in shower system
- D Unterputz-duschsystem
- RUS Душевой гарнитур скрытого монтажа
- CZ Sprchový podomítkový set
- RO Set de dus incastat baterie
- H Falsik alatti zuhanyzett
- E Sistema dual de ducha empotrado



FALA

No.	series / seria	box
75870	STEELY R	4

- PL Bateria umywalkowa
- GB Basin mixer
- D Einhand-Waschtischbatterie
- RUS Смеситель для раковины
- CZ Umyvadlová baterie
- RO Baterie lavabo
- H Mosdó csaptelep
- E Monomando de lavabo



FALA

No.	series / seria	box
75807	RETRO BLACK 1	12

- PL Bateria wannowa
- GB Bath mixer
- D Einhand-Wannenbatterie
- RUS Смеситель для ванны
- CZ Vánové baterie
- RO Baterie cada / dus
- H Egykaros kádcsaptelep
- E Monomando para bañoo



FALA

No.	series / seria	
75808	RETRO BLACK 1	12

- PL Bateria umywalkowa
- GB Basin mixer
- D Einhand-Waschtischbatterie
- RUS Смеситель для раковины
- CZ Umyvadlová baterie
- RO Baterie lavoar
- H Mosdó csaptelep
- E Monomando de lavabo



FALA

No.	series / seria	
75811	RETRO BLACK 2	12

- PL Kolumna prysznicowa
- GB Shower column
- D Duschsäule
- RUS Душевая штанга
- CZ Sprchový sloup
- RO Coloană de duș
- H Zuhanyoszlop
- E Columna de ducha



FALA

No.	serie / seria	
75813	RETRO BLACK 2	5

- PL Kolumna prysznicowa
- GB Shower column
- D Duschsäule
- RUS Душевая штанга
- CZ Sprchový sloup
- RO Coloană de duș
- H Zuhanyoszlop
- E Columna de ducha

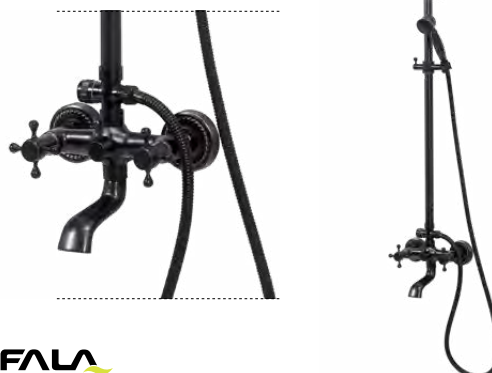

FALA

No.	series / seria	
75809	RETRO BLACK 1	5

- PL Bateria umywalkowa wysoka
- GB Basin mixer
- D Einhand-Waschtischbatterie
- RUS Смеситель для раковины
- CZ Umyvadlová baterie
- RO Baterie lavoar
- H Mosdó csaptelep
- E Monomando de lavabo



FALA

No.	series / seria	
75812	RETRO BLACK 2	12

- PL Bateria umywalkowa
- GB Basin mixer
- D Einhand-Waschtischbatterie
- RUS Смеситель для раковины
- CZ Umyvadlová baterie
- RO Baterie lavoar
- H Mosdó csaptelep
- E Monomando de lavabo



FALA

No.	series / seria	
75814	RETRO BLACK 3	12

- PL Bateria umywalkowa wysoka
- GB Basin mixer
- D Einhand-Waschtischbatterie
- RUS Смеситель для раковины
- CZ Umyvadlová baterie
- RO Baterie lavoar
- H Mosdó csaptelep
- E Monomando de lavabo



FALA

No.	series / seria	box
75815	RETRO BLACK 3	6

- PL Bateria prysznicowa
- GB Single-lever shower mixer
- D Einhand-Brausebatterie
- RUS Смеситель для душа
- CZ Sprchová baterie
- RO Baterie dus
- H Egykaros zuhanycsaptelep
- E Monomando de ducha



FALA

No.	series / seria	box
75817	RETRO BLACK 3	12

- PL Bateria umywalkowa
- GB Basin mixer
- D Einhand-Waschtischbatterie
- RUS Смеситель для раковины
- CZ Umyvadlová baterie
- RO Baterie lavoar
- H Mosdó csaptelep
- E Monomando de lavabo



FALA

No.	series / seria	box
75827	RETRO BRONZE 1	12

- PL Bateria wannowa
- GB Bath mixer
- D Einhand-Wannenbatterie
- RUS Смеситель для ванны
- CZ Vanové baterie
- RO Baterie cada / dus
- H Egykaros kádcsaptelep
- E Monomando para baño



FALA

No.	series / seria	box
75816	RETRO BLACK 3	12

- PL Kolumna prysznicowa
- GB Shower column
- D Duschsäule
- RUS Душевая штанга
- CZ Sprchový sloup
- RO Coloană de duș
- H Zuhanyoszlop
- E Columna de ducha



FALA

No.	series / seria	box
75818	RETRO BLACK 3	5

- PL Bateria wannowa
- GB Bath mixer
- D Einhand-Wannenbatterie
- RUS Смеситель для ванны
- CZ Vanové baterie
- RO Baterie cada / dus
- H Egykaros kádcsaptelep
- E Monomando para baño



FALA

No.	series / seria	box
75828	RETRO BRONZE 1	12

- PL Kolumna prysznicowa
- GB Shower column
- D Duschsäule
- RUS Душевая штанга
- CZ Sprchový sloup
- RO Coloană de duș
- H Zuhanyoszlop
- E Columna de ducha

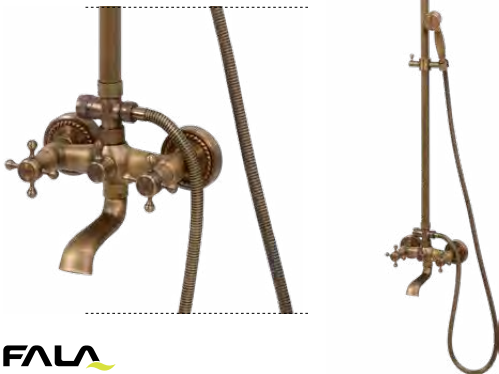

FALA

No.	series / seria	
75829	RETRO BRONZE 1	5

- PL Bateria umywalkowa wysoka
- GB Basin mixer
- D Einhand-Waschtischbatterie
- RUS Смеситель для раковины
- CZ Umyvadlová baterie
- RO Baterie lavoar
- H Mosdó csaptelep
- E Monomando de lavabo



FALA

No.	series / seria	
75837	RETRO BRONZE 2	12

- PL Bateria zlewozmywakowa
- GB Single-lever sink mixer
- D Einhand-Spültischbatterie
- RUS Смеситель для кухни
- CZ Dřezová baterie
- RO Baterie stativă bucatărie
- H Mosogató csaptelep
- E Monomando de fregadero

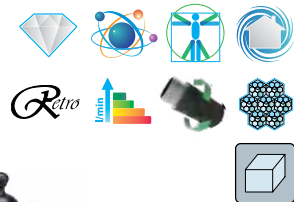

FALA

No.	series / seria	
75834	RETRO BLACK 1	12

- PL Bateria umywalkowa
- GB Basin mixer
- D Einhand-Waschtischbatterie
- RUS Смеситель для раковины
- CZ Umyvadlová baterie
- RO Baterie lavoar
- H Mosdó csaptelep
- E Monomando de lavabo

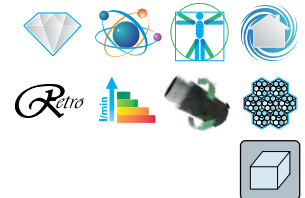

FALA

No.	series / seria	
75836	RETRO BRONZE 2	12

- PL Kolumna prysznicowa
- GB Shower column
- D Duschsäule
- RUS Душевая штанга
- CZ Sprchový sloup
- RO Coloană de duș
- H Zuhanyoszlop
- E Columna de ducha

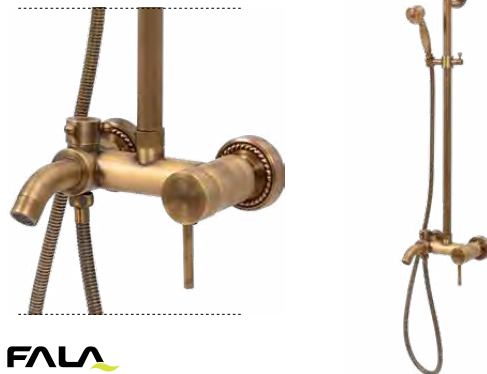

FALA

No.	series / seria	
75838	RETRO BRONZE 2	5

- PL Bateria zlewozmywakowa
- GB Single-lever sink mixer
- D Einhand-Spültischbatterie
- RUS Смеситель для кухни
- CZ Dřezová baterie
- RO Baterie stativă bucatărie
- H Mosogató csaptelep
- E Monomando de fregadero



FALA

No.	series / seria	
75835	RETRO BLACK 2	12

- PL Bateria zlewozmywakowa
- GB Single-lever sink mixer
- D Einhand-Spültischbatterie
- RUS Смеситель для кухни
- CZ Dřezová baterie
- RO Baterie stativă bucatărie
- H Mosogató csaptelep
- E Monomando de fregadero



FALA

No.	series / seria	Icon
75830	RETRO BRONZE 1	12

- PL Bateria zlewozmywakowa
- GB Single-lever sink mixer
- D Einhand-Spültischbatterie
- RUS Смеситель для кухни
- CZ Dřezová baterie
- RO Baterie stativă bucatărie
- H Mosogató csaptelep
- E Monomando de fregadero



FALA

No.	series / seria	Icon
75832	RETRO BRONZE 3	12

- PL Bateria umywalkowa
- GB Basin mixer
- D Einhand-Waschtischbatterie
- RUS Смеситель для раковины
- CZ Umyvadlová baterie
- RO Baterie lavoar
- H Mosdó csaptelep
- E Monomando de lavabo



FALA

No.	series / seria	Icon
75740	TARRAGONA	10

- PL Bateria zlewozmywakowa
- GB Single-lever sink mixer
- D Einhand-Spültischbatterie
- RUS Смеситель для кухни
- CZ Dřezová baterie
- RO Baterie stativă bucatărie
- H Mosogató csaptelep
- E Monomando de fregadero

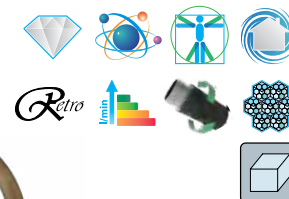

FALA

No.	series / seria	Icon
75831	RETRO BRONZE 2	12

- PL Bateria zlewozmywakowa
- GB Single-lever sink mixer
- D Einhand-Spültischbatterie
- RUS Смеситель для кухни
- CZ Dřezová baterie
- RO Baterie stativă bucatărie
- H Mosogató csaptelep
- E Monomando de fregadero

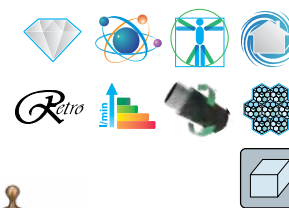

FALA

No.	series / seria	Icon
75833	RETRO BRONZE 4	12

- PL Bateria wannowa
- GB Bath mixer
- D Einhand-Wannenbatterie
- RUS Смеситель для ванны
- CZ Vanové baterie
- RO Baterie cada / dus
- H Egykaros kádcsaptelep
- E Monomando para bañoo



FALA

No.	series / seria	Icon
75742	TARRAGONA	8

- PL Bateria prysznicowa
- GB Single-lever shower mixer
- D Einhand-Brausebatterie
- RUS Смеситель для душа
- CZ Sprchová baterie
- RO Bateria dus
- H Egykaros zuhanycsaptelep
- E Monomando de ducha



FALA

No.	series / seria	Box
75743	TARRAGONA	10

- PL Bateria wannowa
- GB Bath mixer
- D Einhand-Wannenbatterie
- RUS Смеситель для ванны
- CZ Vanové baterie
- RO Bateria cada / dus
- H Egykaros kádcsaptelep
- E Monomando para bañoo



FALA

No.	series / seria	Box
75772	ALICANTE	8

- PL Bateria zlewozmywakowa
- GB Single-lever sink mixer
- D Einhand-Spültischbatterie
- RUS Смеситель для раковины
- CZ Dřezová baterie
- RO Bateria stativă bucătărie
- H Mosogató csaptelep
- E Monomando de fregadero



FALA

No.	series / seria	Box
75774	ALICANTE	8

- PL Bateria umywalkowa
- GB Basin mixer
- D Einhand-Waschtischbatterie
- RUS Смеситель для раковины
- CZ Umyvadlová baterie
- RO Bateria lavoar
- H Mosdó csaptelep
- E Monomando de lavabo



FALA

No.	series / seria	Box
75770	ALICANTE	10

- PL Bateria prysznicowa
- GB Single-lever shower mixer
- D Einhand-Brausebatterie
- RUS Смеситель для душа
- CZ Sprchová baterie
- RO Bateria dus
- H Egykaros zuhanycsaptelep
- E Monomando de ducha



FALA

No.	series / seria	Box
75773	ALICANTE	10

- PL Bateria umywalkowa
- GB Basin mixer
- D Einhand-Waschtischbatterie
- RUS Смеситель для раковины
- CZ Umyvadlová baterie
- RO Bateria lavoar
- H Mosdó csaptelep
- E Monomando de lavabo



FALA

No.	series / seria	Box
75760	SORIA	10

- PL Bateria wannowa
- GB Bath mixer
- D Einhand-Wannenbatterie
- RUS Смеситель для ванны
- CZ Vanové baterie
- RO Baterie cada / dus
- H Egykaros kádcsaptelep
- E Monomando para baño



FALA

No.	series / seria	☐
75762	SORIA	8

- PL Bateria zlewozmywakowa
- GB Single-lever sink mixer
- D Einhand-Spültischbatterie
- RUS Смеситель для раковины
- CZ Dřezová baterie
- RO Baterie stativă bucătărie
- H Mosogató csaptelep
- E Monomando de fregadero



FALA

No.	series / seria	☐
75764	SORIA	8

- PL Bateria wannowa
- GB Bath mixer
- D Einhand-Wannenbatterie
- RUS Смеситель для ванны
- CZ Vanové baterie
- RO Baterie cada / dus
- H Egykaros kádcsaptelep
- E Monomando para baño

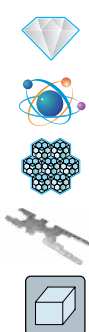

FALA

No.	series / seria	☐
75767	MURCIA	8

- PL Bateria prysznicowa
- GB Single-lever shower mixer
- D Einhand-Brausebatterie
- RUS Смеситель для душа
- CZ Sprchová baterie
- RO Baterie dus
- H Egykaros zuhanycsaptelep
- E Monomando de ducha



FALA

No.	series / seria	☐
75763	SORIA	10

- PL Bateria umywalkowa
- GB Basin mixer
- D Einhand-Waschtischbatterie
- RUS Смеситель для раковины
- CZ Umyvadlová baterie
- RO Baterie lavoar
- H Mosdó csaptelep
- E Monomando de lavabo



FALA

No.	series / seria	☐
75765	MURCIA	10

- PL Bateria prysznicowa
- GB Single-lever shower mixer
- D Einhand-Brausebatterie
- RUS Смеситель для душа
- CZ Sprchová baterie
- RO Baterie dus
- H Egykaros zuhanycsaptelep
- E Monomando de ducha



FALA

No.	series / seria	☐
75768	MURCIA	10

- PL Bateria umywalkowa
- GB Basin mixer
- D Einhand-Waschtischbatterie
- RUS Смеситель для раковины
- CZ Umyvadlová baterie
- RO Baterie lavoar
- H Mosdó csaptelep
- E Monomando de lavabo



FALA

No.	series / seria	☐
75745	BURGOS	10

- PL Bateria prysznicowa
- GB Single-lever shower mixer
- D Einhand-Brausebatterie
- RUS Смеситель для душа
- CZ Sprchová baterie
- RO Baterie dus
- H Egykaros zuhanycsaptelep
- E Monomando de ducha



FALA

No.	series / seria	☐
75748	BURGOS	10

- PL Bateria zlewozmywakowa
- GB Single-lever sink mixer
- D Einhand-Spültischbatterie
- RUS Смеситель для кухни
- CZ Dřezová baterie
- RO Baterie stativă bucătărie
- H Mosogató csaptelep
- E Monomando de fregadero

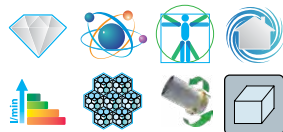

FALA

No.	series / seria	☐
75705	FLEXIBLE-BLACK	10

Flexible spout allows for any shaping.
Elastyczna wylewka umożliwia dowolne kształtowanie.

- PL Bateria wannowa
- GB Bath mixer
- D Einhand-Wannenbatterie
- RUS Смеситель для ванны
- CZ Vanové baterie
- RO Baterie cada / dus
- H Egykaros kádcsaptelep
- E Monomando para bañó



FALA

No.	series / seria	☐
75747	BURGOS	8

- PL Bateria zlewozmywakowa
- GB Single-lever sink mixer
- D Einhand-Spültischbatterie
- RUS Смеситель для кухни
- CZ Dřezová baterie
- RO Baterie stativă bucătărie
- H Mosogató csaptelep
- E Monomando de fregadero



FALA

No.	series / seria	☐
75749	BURGOS	8

- PL Bateria zlewozmywakowa
- GB Single-lever sink mixer
- D Einhand-Spültischbatterie
- RUS Смеситель для кухни
- CZ Dřezová baterie
- RO Baterie stativă bucătărie
- H Mosogató csaptelep
- E Monomando de fregadero

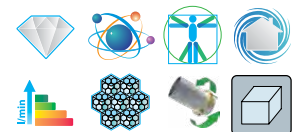

FALA

No.	series / seria	☐
75706	FLEXIBLE-WHITE	10

Flexible spout allows for any shaping.
Elastyczna wylewka umożliwia dowolne kształtowanie.

- PL Bateria zlewozmywakowa
- GB Single-lever sink mixer
- D Einhand-Spültischbatterie
- RUS Смеситель для кухни
- CZ Dřezová baterie
- RO Baterie stativă bucatărie
- H Mosogató csaptelep
- E Monomando de fregadero

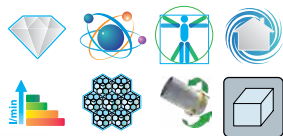

Flexible spout allows for any shaping.
Elastyczna wylewka umożliwia dowolne kształtowanie.



No.	series / seria	☐
75707	FLEXIBLE-RED	10

- PL Bateria zlewozmywakowa
- GB Single-lever sink mixer
- D Einhand-Spültischbatterie
- RUS Смеситель для кухни
- CZ Dřezová baterie
- RO Baterie stativă bucatărie
- H Mosogató csaptelep
- E Monomando de fregadero

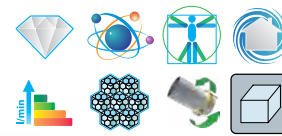

Flexible spout allows for any shaping.
Elastyczna wylewka umożliwia dowolne kształtowanie.



No.	series / seria	☐
75708	FLEXIBLE-ORANGE	10

- PL Bateria zlewozmywakowa
- GB Single-lever sink mixer
- D Einhand-Spültischbatterie
- RUS Смеситель для кухни
- CZ Dřezová baterie
- RO Baterie stativă bucatărie
- H Mosogató csaptelep
- E Monomando de fregadero

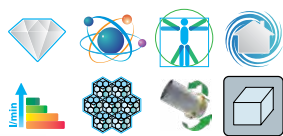

Flexible spout allows for any shaping.
Elastyczna wylewka umożliwia dowolne kształtowanie.



No.	series / seria	☐
75709	FLEXIBLE-GREEN	10

- PL Bateria zlewozmywakowa
- GB Single-lever sink mixer
- D Einhand-Spültischbatterie
- RUS Смеситель для кухни
- CZ Dřezová baterie
- RO Baterie stativă bucatărie
- H Mosogató csaptelep
- E Monomando de fregadero

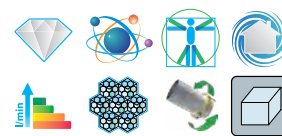

Flexible spout allows for any shaping.
Elastyczna wylewka umożliwia dowolne kształtowanie.



No.	series / seria	☐
75675	FLEXIBLE 2 BLACK	10

- PL Bateria zlewozmywakowa
- GB Single-lever sink mixer
- D Einhand-Spültischbatterie
- RUS Смеситель для кухни
- CZ Dřezová baterie
- RO Baterie stativă bucatărie
- H Mosogató csaptelep
- E Monomando de fregadero

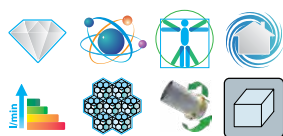

Flexible spout allows for any shaping.
Elastyczna wylewka umożliwia dowolne kształtowanie.



No.	series / seria	☐
75676	FLEXIBLE 2 WHITE	10

- PL Bateria zlewozmywakowa
- GB Single-lever sink mixer
- D Einhand-Spültischbatterie
- RUS Смеситель для кухни
- CZ Dřezová baterie
- RO Baterie stativă bucatărie
- H Mosogató csaptelep
- E Monomando de fregadero

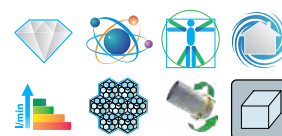

Flexible spout allows for any shaping.
Elastyczna wylewka umożliwia dowolne kształtowanie.



No.	series / seria	☐
75677	FLEXIBLE 2 RED	10

- PL Bateria zlewozmywakowa
- GB Single-lever sink mixer
- D Einhand-Spültischbatterie
- RUS Смеситель для кухни
- CZ Dřezová baterie
- RO Baterie stativă bucatărie
- H Mosogató csaptelep
- E Monomando de fregadero

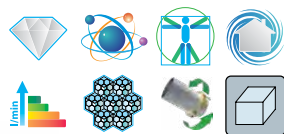

Flexible spout allows for any shaping.

Elastyczna wylewka umożliwia dowolne kształtowanie.

FALA

No.	series / seria	Box
75678	FLEXIBLE 2 ORANGE	10

- PL Bateria zlewozmywakowa ścienna
- GB Single-lever sink mixer
- D Einhand-Spültischbatterie
- RUS Смеситель для кухни
- CZ Dřezová baterie
- RO Baterie stativă bucatărie
- H Mosogató csaptelep
- E Monomando de fregadero

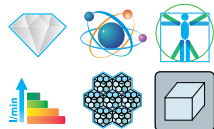

Flexible spout allows for any shaping.

Elastyczna wylewka umożliwia dowolne kształtowanie.

FALA

No.	series / seria	Box
75670	FLEXIBLE - BLACK	10

- PL Bateria zlewozmywakowa ścienna
- GB Single-lever sink mixer
- D Einhand-Spültischbatterie
- RUS Смеситель для кухни
- CZ Dřezová baterie
- RO Baterie stativă bucatărie
- H Mosogató csaptelep
- E Monomando de fregadero

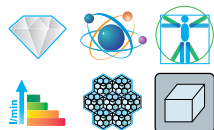

Flexible spout allows for any shaping.

Elastyczna wylewka umożliwia dowolne kształtowanie.

FALA

No.	series / seria	Box
75672	FLEXIBLE - RED	10

- PL Bateria zlewozmywakowa
- GB Single-lever sink mixer
- D Einhand-Spültischbatterie
- RUS Смеситель для кухни
- CZ Dřezová baterie
- RO Baterie stativă bucatărie
- H Mosogató csaptelep
- E Monomando de fregadero

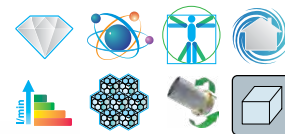

Flexible spout allows for any shaping.

Elastyczna wylewka umożliwia dowolne kształtowanie.

FALA

No.	series / seria	Box
75679	FLEXIBLE 2 GREEN	10

- PL Bateria zlewozmywakowa ścienna
- GB Single-lever sink mixer
- D Einhand-Spültischbatterie
- RUS Смеситель для кухни
- CZ Dřezová baterie
- RO Baterie stativă bucatărie
- H Mosogató csaptelep
- E Monomando de fregadero

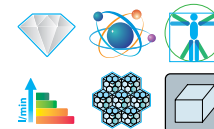

Flexible spout allows for any shaping.

Elastyczna wylewka umożliwia dowolne kształtowanie.

FALA

No.	series / seria	Box
75671	FLEXIBLE - WHITE	10

- PL Bateria zlewozmywakowa ścienna
- GB Single-lever sink mixer
- D Einhand-Spültischbatterie
- RUS Смеситель для кухни
- CZ Dřezová baterie
- RO Baterie stativă bucatărie
- H Mosogató csaptelep
- E Monomando de fregadero

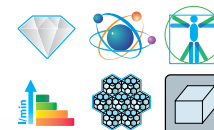

Flexible spout allows for any shaping.

Elastyczna wylewka umożliwia dowolne kształtowanie.

FALA

No.	series / seria	Box
75673	FLEXIBLE - ORANGE	10

- PL Bateria zlewozmywakowa ścienna
- GB Single-lever sink mixer
- D Einhand-Spültischbatterie
- RUS Смеситель для кухни
- CZ Dřezová baterie
- RO Baterie stativă bucătărie
- H Mosogató csaptelep
- E Monomando de fregadero

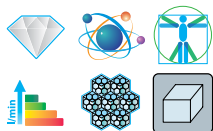

Flexible spout allows for any shaping.

Elastyczna wylewka umożliwia dowolne kształtowanie.

FALA

No.	series / seria	☐
75674	FLEXIBLE - GREEN	10

- PL Korek z sitkiem
- GB Pop-up waste
- D Waschbecken Stöpsel
- RUS Пробка
- CZ Zátka
- RO Sifon chiuveta
- H Mosdo lefolyó elzáró
- E Tapón

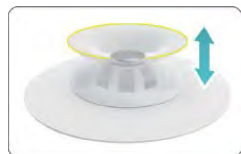
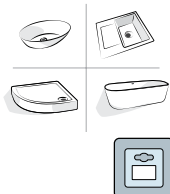

FALA

No.	☐
74781	240

- PL Korek z sitkiem
- GB Pop-up waste
- D Waschbecken Stöpsel
- RUS Пробка
- CZ Zátka
- RO Sifon chiuveta
- H Mosdo lefolyó elzáró
- E Tapón

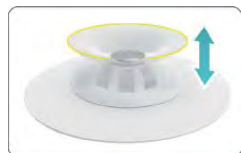
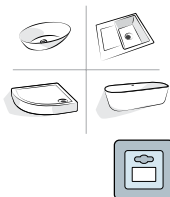

FALA

No.	☐
74783	240

- PL Korek z sitkiem
- GB Pop-up waste
- D Waschbecken Stöpsel
- RUS Пробка
- CZ Zátka
- RO Sifon chiuveta
- H Mosdo lefolyó elzáró
- E Tapón

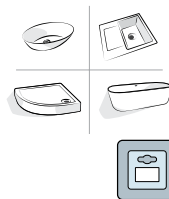

FALA

No.	☐
74780	240

- PL Korek z sitkiem
- GB Pop-up waste
- D Waschbecken Stöpsel
- RUS Пробка
- CZ Zátka
- RO Sifon chiuveta
- H Mosdo lefolyó elzáró
- E Tapón

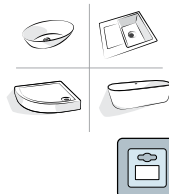

FALA

No.	☐
74782	240

- PL Korek z sitkiem
- GB Pop-up waste
- D Waschbecken Stöpsel
- RUS Пробка
- CZ Zátka
- RO Sifon chiuveta
- H Mosdo lefolyó elzáró
- E Tapón

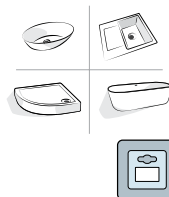

FALA

No.	☐
74784	240

PL Organizer
GB Organizer
D Organizer
RUS Организатор
CZ Organizér
RO Organizator
H Szervező
E Organizador



FALA

No.

74785



144

PL Organizer
GB Organizer
D Organizer
RUS Организатор
CZ Organizér
RO Organizator
H Szervező
E Organizador



FALA

No.

74787



144

PL Organizer
GB Organizer
D Organizer
RUS Организатор
CZ Organizér
RO Organizator
H Szervező
E Organizador



FALA

No.

74789



144

PL Mata
GB Mat
D Matte
RUS Коврик
CZ Podložka
RO Mat
H Lábtörő
E Alfombra



FALA

No.

74791



50/200

PL Organizer
GB Organizer
D Organizer
RUS Организатор
CZ Organizér
RO Organizator
H Szervező
E Organizador



FALA

No.

74786



144

PL Organizer
GB Organizer
D Organizer
RUS Организатор
CZ Organizér
RO Organizator
H Szervező
E Organizador



FALA

No.

74788



144

PL Mata
GB Mat
D Matte
RUS Коврик
CZ Podložka
RO Mat
H Lábtörő
E Alfombra



FALA

No.

74790



50/200

PL Mata
GB Mat
D Matte
RUS Коврик
CZ Podložka
RO Mat
H Lábtörő
E Alfombra



FALA

No.

74792



50/200

PL Mata
GB Mat
D Matte
RUS Коврик
CZ Podložka
RO Mat
H Lábtörő
E Alfombra



FALA

No.
74793



50/200

PL Dozownik mydła w płynie
GB Soap dispenser
D Seifenspender
RUS Дозатор для мыла
CZ Dávkovač mýdla
RO Dozator sapun lichid
H Folyékonyszappan adagoló
E Dispensador de jabón



FALA

No.
69395



100

PL Dozownik mydła w płynie
GB Soap dispenser
D Seifenspender
RUS Дозатор для мыла
CZ Dávkovač mýdla
RO Dozator sapun lichid
H Folyékonyszappan adagoló
E Dispensador de jabón



FALA

No.
69397



100

PL Dozownik mydła w płynie
GB Soap dispenser
D Seifenspender
RUS Дозатор для мыла
CZ Dávkovač mýdla
RO Dozator sapun lichid
H Folyékonyszappan adagoló
E Dispensador de jabón



FALA

No.
69391



2/24

PL Mata
GB Mat
D Matte
RUS Коврик
CZ Podložka
RO Mat
H Lábtörő
E Alfombra



FALA

No.
74794



50/200

PL Dozownik mydła w płynie
GB Soap dispenser
D Seifenspender
RUS Дозатор для мыла
CZ Dávkovač mýdla
RO Dozator sapun lichid
H Folyékonyszappan adagoló
E Dispensador de jabón



FALA

No.
69396



100

PL Dozownik mydła w płynie
GB Soap dispenser
D Seifenspender
RUS Дозатор для мыла
CZ Dávkovač mýdla
RO Dozator sapun lichid
H Folyékonyszappan adagoló
E Dispensador de jabón



FALA

No.
69390



48



<p>Special inspection window for 100% outflow control and comfortable cleaning.</p> <p>Specjalne okienko rewizyjne to 100% kontroli drożności i wygodne czyszczenie.</p>  <p>SMARTthru</p>	<p>Easy to clean thanks to contained hook.</p> <p>Łatwy do utrzymania w czystości dzięki dołączonemu haczykowi.</p>  <p>EASVclean</p>	<p>Stabilizing body grips, additional stiffening in the floor.</p> <p>Uchwyty stabilizujące korpus. Dodatkowe usztywnienie konstrukcji w podłodze.</p>  <p>GRIPstrong</p>
<p>Waterproof cloth included – as essential part of waterproofing.</p> <p>Mata uszczelniająca w zestawie – niezbędna część przy wykonywaniu hydroizolacji.</p>  <p>HYDRCloth</p>	<p>Effective and durable strainer which prevents clogging of the trap and makes cleaning easier.</p> <p>Skuteczne i trwałe sito, które zapobiega zapychaniu syfonu oraz ułatwia bieżącą obsługę odpływu.</p>  <p>STRAINer</p>	<p>High quality precision welds guarantee no leaking of the drain.</p> <p>Wysokiej jakości precyzyjne spawy gwarantujące szczelność odpływu.</p>  <p>HQwelding</p>
<p>Low siphon made of stainless steel AISI 304 makes installation easier.</p> <p>Niski syfon wykonany ze stali nierdzewnej AISI 304 ułatwiający instalację.</p>  <p>52 mm EXTRASlim</p>	<p>Wide range of height adjustment allows adjusting to the floor level.</p> <p>Szeroki zakres regulacji wysokości, który umożliwia dopasowanie odpływu do powierzchni posadzki.</p>  <p>EASYfix</p>	<p>It can prevent stink and worms both in use and after dry (no water in siphon).</p> <p>Zapobiega przedostawaniu się zapachów oraz robaków podczas używania jak i po wysuszeniu (brak wody w syfonie).</p>  <p>WET&DRY</p>

PL Odpływ liniowy CZ Odtokowy żłab
GB Linear drain RO Rigola dus
D Duschrinne H Zuhanyfolyoka
RUS Душевой лоток E Canal de ducha



PL Odpływ liniowy CZ Odtokowy żłab
GB Linear drain RO Rigola dus
D Duschrinne H Zuhanyfolyoka
RUS Душевой лоток E Canal de ducha

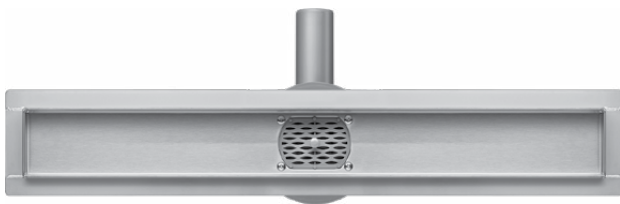

FALA



No.	L (cm)	series / seria	
75345	50	ROTARY	5
75346	60	ROTARY	5
75347	70	ROTARY	5
75348	80	ROTARY	5
75349	90	ROTARY	5

PL Odpływ liniowy CZ Odtokowy żłab
GB Linear drain RO Rigola dus
D Duschrinne H Zuhanyfolyoka
RUS Душевой лоток E Canal de ducha

FALA

No.	L (cm)	series / seria	
75350	30	BRICK	5
75351	40	BRICK	5
75352	50	BRICK	5
75353	60	BRICK	5
75354	70	BRICK	5
75355	80	BRICK	5
75356	90	BRICK	5

FALA

No.	L (cm)	series / seria	packing	
75360	30	MADEIRA		6
75361	40	MADEIRA		6
75362	50	MADEIRA		6
75363	60	MADEIRA		6
75364	70	MADEIRA		6
75365	80	MADEIRA		6
75366	90	MADEIRA		6



PL Odpływ liniowy CZ Odtokowy żłab
 GB Linear drain RO Rigola dus
 D Duschrinne H Zuhanyfolyóka
 RUS Душевой лоток E Canal de ducha



FALA

No.	L (cm)	series / seria	packing	
75367	30	TOCANTINS		6
75368	40	TOCANTINS		6
75369	50	TOCANTINS		6
75370	60	TOCANTINS		6
75371	70	TOCANTINS		6
75372	80	TOCANTINS		6
75373	90	TOCANTINS		6

PL Odpływ liniowy CZ Odtokowy żłab
 GB Linear drain RO Rigola dus
 D Duschrinne H Zuhanyfolyóka
 RUS Душевой лоток E Canal de ducha



FALA

No.	L (cm)	series / seria	
75381	60	WHITE GLASS	6
75382	70	WHITE GLASS	6
75383	80	WHITE GLASS	6
75384	90	WHITE GLASS	6

PL Odpływ liniowy CZ Odtokowy żłab
 GB Linear drain RO Rigola dus
 D Duschrinne H Zuhanyfolyóka
 RUS Душевой лоток E Canal de ducha



FALA

No.	L (cm)	series / seria	
75421	60	OLIMP	6
75422	70	OLIMP	6
75423	80	OLIMP	6
75424	90	OLIMP	6

PL Odpływ liniowy CZ Odtokowy żłab
 GB Linear drain RO Rigola dus
 D Duschrinne H Zuhanyfolyóka
 RUS Душевой лоток E Canal de ducha



FALA

No.	L (cm)	series / seria	packing	
75374	30	NAPO		6
75375	40	NAPO		6
75376	50	NAPO		6
75377	60	NAPO		6
75378	70	NAPO		6
75379	80	NAPO		6
75380	90	NAPO		6

PL Odpływ liniowy CZ Odtokowy żłab
 GB Linear drain RO Rigola dus
 D Duschrinne H Zuhanyfolyóka
 RUS Душевой лоток E Canal de ducha



FALA

No.	L (cm)	series / seria	
75386	60	BLACK GLASS	6
75387	70	BLACK GLASS	6
75388	80	BLACK GLASS	6
75389	90	BLACK GLASS	6

PL Odpływ liniowy CZ Odtokowy żłab
 GB Linear drain RO Rigola dus
 D Duschrinne H Zuhanyfolyóka
 RUS Душевой лоток E Canal de ducha



FALA

No.	L (cm)	series / seria	
75448	60	LINE	6
75449	70	LINE	6
75450	80	LINE	6
75451	90	LINE	6

- PL Perlator i zestaw uszczelek do baterii
 GB Aerator and sealing set for sanitary mixers
 D Strahlregler- und Dichtungsgummissatz für Armatur
 RUS Аэратор с набором прокладок для смесителя
- CZ Perlátor a sada těsnění do baterie
 RO Sita și garnitură pt. baterii sanitare
 H Levegőztető és tömítőgumi készlet csaptelephez
 E Aireado y juego de juntas

FALA

No. 75327  25/200

- PL Korek do umywalki
 GB Pop-up waste
 D Waschbecken Stöpsel
 RUS Автоматическая пробка
 CZ Automatická zátká
 RO Sifon chiuveta
 H Mosdo lefolyó elzáró
 E Tapón automat. para batería de lado

G 1 1/4

 UNIVERSAL THREAD
 UNIWERSALNY GWINT



FALA

No. 75498  12/48

- PL Korek automatyczny
 GB Pop-up waste
 D Waschbecken Stöpsel
 RUS Автоматическая пробка для умывальника
 CZ Automatická zátká
 RO Sifon chiuveta
 H Mosdo lefolyó elzáró
 E Tapón automat. para batería de lado



G 1 1/4

 UNIVERSAL THREAD
 UNIWERSALNY GWINT

FOR WASH BASINS WITH OVERFLOW
 DO UMYWALEK Z PRZELIWIEM
 CHROME PLATED
 CHROMOWANY



FALA

No. 75483  48/96

- PL Korek automatyczny
 GB Pop-up waste
 D Waschbecken Stöpsel
 RUS Автоматическая пробка для умывальника
 CZ Automatická zátká
 RO Sifon chiuveta
 H Mosdo lefolyó elzáró
 E Tapón automat. para batería de lado



G 1 1/4

 UNIVERSAL THREAD
 UNIWERSALNY GWINT

FOR WASH BASINS WITH OVERFLOW
 DO UMYWALEK Z PRZELIWIEM
 BRASS
 MOSIĄDZ

CHROME PLATED
 CHROMOWANY



FALA

No. 75487  20/40



- PL Korek do umywalki
 GB Pop-up waste
 D Waschbecken Stöpsel
 RUS Автоматическая пробка
 CZ Automatická zátká
 RO Sifon chiuveta
 H Mosdo lefolyó elzáró
 E Tapón automat. para batería de lado

G 1 1/4

 UNIVERSAL THREAD
 UNIWERSALNY GWINT



FALA

No. 75499  12/48

- PL Korek automatyczny
 GB Pop-up waste
 D Waschbecken Stöpsel
 RUS Автоматическая пробка для умывальника
 CZ Automatická zátká
 RO Sifon chiuveta
 H Mosdo lefolyó elzáró
 E Tapón automat. para batería de lado

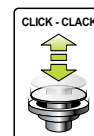

G 1 1/4

 UNIVERSAL THREAD
 UNIWERSALNY GWINT

FOR WASH BASINS WITH OVERFLOW
 DO UMYWALEK Z PRZELIWIEM
 BRASS
 MOSIĄDZ

CHROME PLATED
 CHROMOWANY



FALA

No. 75484  20/40

- PL Słuchawka prysznicowa
 GB Shower handle
 D Handbrause
 RUS Разбрызгиватель для душа
 CZ Ruční sprcha
 RO Cap duș
 H Kézi zuhanyfej
 E Ducha

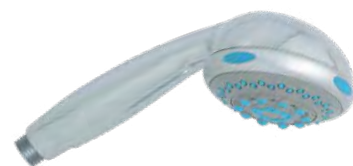

FALA

No. 75540  20/80

PL Sluchawka prysznicowa
 GB Shower handle
 D Handbrause
 RUS Разбрызгиватель для душа
 CZ Ruční sprcha
 RO Cap duș
 H Kézi zuhanyfej
 E Ducha



FALA

No.	
75541	20/80

PL Sluchawka prysznicowa
 GB Shower handle
 D Handbrause
 RUS Разбрызгиватель для душа
 CZ Ruční sprcha
 RO Cap duș
 H Kézi zuhanyfej
 E Ducha

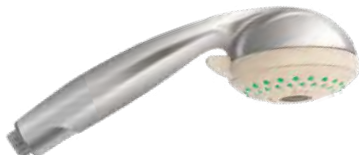
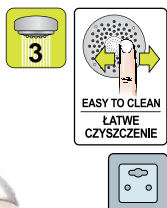

FALA

No.	
75543	15/60

PL Sluchawka prysznicowa
 GB Shower handle
 D Handbrause
 RUS Разбрызгиватель для душа
 CZ Ruční sprcha
 RO Cap duș
 H Kézi zuhanyfej
 E Ducha



FALA

No.	
75544	15/60

PL Sluchawka prysznicowa
 GB Shower handle
 D Handbrause
 RUS Разбрызгиватель для душа
 CZ Ruční sprcha
 RO Cap duș
 H Kézi zuhanyfej
 E Ducha

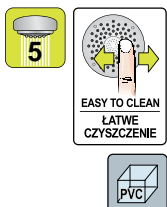

FALA

No.	series / seria	
75550	DELTA	30/60

PL Sluchawka prysznicowa
 GB Shower handle
 D Handbrause
 RUS Разбрызгиватель для душа
 CZ Ruční sprcha
 RO Cap duș
 H Kézi zuhanyfej
 E Ducha

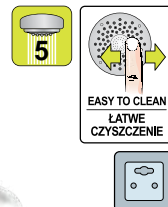

FALA

No.	
75543	12/48

PL Sluchawka prysznicowa
 GB Shower handle
 D Handbrause
 RUS Разбрызгиватель для душа
 CZ Ruční sprcha
 RO Cap duș
 H Kézi zuhanyfej
 E Ducha

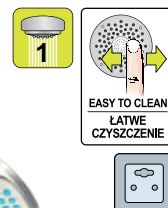

FALA

No.	
75544	15/60

PL Sluchawka prysznicowa
 GB Shower handle
 D Handbrause
 RUS Разбрызгиватель для душа
 CZ Ruční sprcha
 RO Cap duș
 H Kézi zuhanyfej
 E Ducha

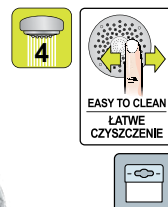

FALA

No.	
75551	30/60

PL Sluchawka prysznicowa
 GB Shower handle
 D Handbrause
 RUS Разбрызгиватель для душа
 CZ Ruční sprcha
 RO Cap duș
 H Kézi zuhanyfej
 E Ducha



FALA

No.	series / seria	
75629	TUGELA	24/48

PL Słuchawka prysznicowa
GB Shower handle
D Handbrause
RUS Разбрызгиватель для душа
CZ Ruční sprcha
RO Cap duș
H Kézi zuhanyfej
E Ducha

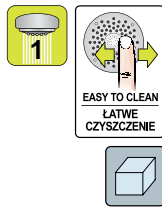

FALA

No.	series / seria	Box
75631	HERMANA	25/50

PL Słuchawka prysznicowa
GB Shower handle
D Handbrause
RUS Разбрызгиватель для душа
CZ Ruční sprcha
RO Cap duș
H Kézi zuhanyfej
E Ducha

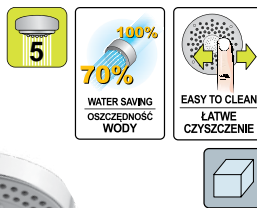

FALA

No.	series / seria	Box
75625	DETIFOS	25/50

PL Słuchawka prysznicowa
GB Shower handle
D Handbrause
RUS Разбрызгиватель для душа
CZ Ruční sprcha
RO Cap duș
H Kézi zuhanyfej
E Ducha

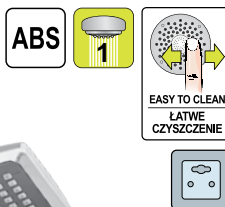

FALA

No.	series / seria	Box
75632	FOBOS	12

PL Słuchawka prysznicowa
GB Shower handle
D Handbrause
RUS Разбрызгиватель для душа
CZ Ruční sprcha
RO Cap duș
H Kézi zuhanyfej
E Ducha

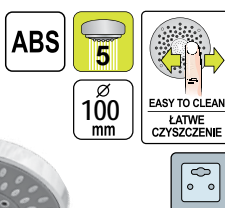

FALA

No.	series / seria	Box
75634	DIONE	12



PL Słuchawka prysznicowa
GB Shower handle
D Handbrause
RUS Разбрызгиватель для душа
CZ Ruční sprcha
RO Cap duș
H Kézi zuhanyfej
E Ducha

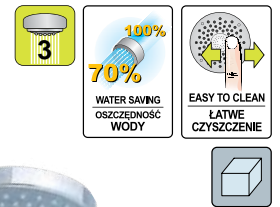

FALA

No.	series / seria	Box
75626	KILE	25/50

PL Słuchawka prysznicowa
GB Shower handle
D Handbrause
RUS Разбрызгиватель для душа
CZ Ruční sprcha
RO Cap duș
H Kézi zuhanyfej
E Ducha

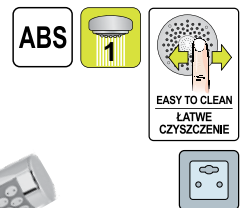

FALA

No.	series / seria	Box
75628	DEIMOS	12

PL Słuchawka prysznicowa
GB Shower handle
D Handbrause
RUS Разбрызгиватель для душа
CZ Ruční sprcha
RO Cap duș
H Kézi zuhanyfej
E Ducha

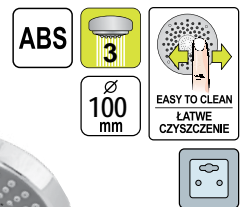

FALA

No.	series / seria	Box
75633	JAPET	12

PL Słuchawka prysznicowa
GB Shower handle
D Handbrause
RUS Разбрызгиватель для душа
CZ Ruční sprcha
RO Cap duș
H Kézi zuhanyfej
E Ducha

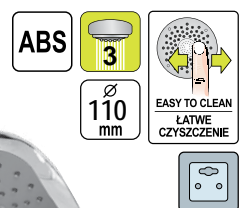

FALA

No.	series / seria	Box
75635	MIMAS	12



PL Słuchawka prysznicowa
GB Shower handle
D Handbrause
RUS Разбрызгиватель для душа
CZ Ruční sprcha
RO Cap duș
H Kézi zuhanyfej
E Ducha



FALA

No.	series / seria	☐
75636	SILVER MOON	12

PL Słuchawka prysznicowa
GB Shower handle
D Handbrause
RUS Разбрызгиватель для душа
CZ Ruční sprcha
RO Cap duș
H Kézi zuhanyfej
E Ducha



FALA

No.	series / seria	☐
75638	SILVER MOON	12

PL Słuchawka prysznicowa
GB Shower handle
D Handbrause
RUS Разбрызгиватель для душа
CZ Ruční sprcha
RO Cap duș
H Kézi zuhanyfej
E Ducha



FALA

No.	series / seria	☐
75624	SALTO	25/50

PL Słuchawka prysznicowa
GB Shower handle
D Handbrause
RUS Разбрызгиватель для душа
CZ Ruční sprcha
RO Cap duș
H Kézi zuhanyfej
E Ducha



FALA

No.	series / seria	☐
75620	SALTO	25/50

PL Słuchawka prysznicowa
GB Shower handle
D Handbrause
RUS Разбрызгиватель для душа
CZ Ruční sprcha
RO Cap duș
H Kézi zuhanyfej
E Ducha



FALA

No.	series / seria	☐
75637	WHITE MOON	12

PL Słuchawka prysznicowa
GB Shower handle
D Handbrause
RUS Разбрызгиватель для душа
CZ Ruční sprcha
RO Cap duș
H Kézi zuhanyfej
E Ducha



FALA

No.	series / seria	☐
75639	WHITE MOON	12

PL Słuchawka prysznicowa
GB Shower handle
D Handbrause
RUS Разбрызгиватель для душа
CZ Ruční sprcha
RO Cap duș
H Kézi zuhanyfej
E Ducha



FALA

No.	series / seria	☐
75619	SALTO	25/50

PL Słuchawka prysznicowa
GB Shower handle
D Handbrause
RUS Разбрызгиватель для душа
CZ Ruční sprcha
RO Cap duș
H Kézi zuhanyfej
E Ducha



FALA

No.	series / seria	☐
75621	SALTO	25/50

PL Sluchawka prysznicowa
GB Shower handle
D Handbrause
RUS Разбрызгиватель для душа
CZ Ruční sprcha
RO Cap duș
H Kézi zuhanyfej
E Ducha

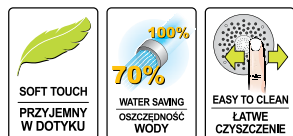

FALA

No.	series / seria	
75622	SALTO	25/50

PL Uchwyt do słuchawki prysznicowej
GB Shower holder
D Brauseporter
RUS Держатель душ
CZ Držák s kloubem na sprchu
RO Suport pt. dus
H Zuhanycső tartó
E Grifo para ducha



FALA

No.		
75527		100

PL Uchwyt do słuchawki prysznicowej
GB Shower holder
D Brauseporter
RUS Держатель душ
CZ Držák s kloubem na sprchu
RO Suport pt. dus
H Zuhanycső tartó
E Grifo para ducha

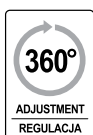

FALA

No.		
75536		100

PL Uchwyt do słuchawki prysznicowej
GB Shower holder
D Brauseporter
RUS Держатель душ
CZ Držák s kloubem na sprchu
RO Suport pt. dus
H Zuhanycső tartó
E Grifo para ducha

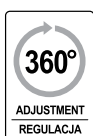

FALA

No.		
75539		100

PL Sluchawka prysznicowa
GB Shower handle
D Handbrause
RUS Разбрызгиватель для душа
CZ Ruční sprcha
RO Cap duș
H Kézi zuhanyfej
E Ducha

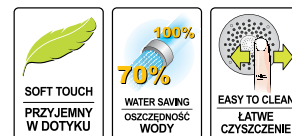

FALA

No.	series / seria	
75623	SALTO	25/50

PL Uchwyt do słuchawki prysznicowej
GB Shower holder
D Brauseporter
RUS Держатель душ
CZ Držák s kloubem na sprchu
RO Suport pt. dus
H Zuhanycső tartó
E Grifo para ducha



FALA

No.		
75535		100

PL Uchwyt do słuchawki prysznicowej
GB Shower holder
D Brauseporter
RUS Держатель душ
CZ Držák s kloubem na sprchu
RO Suport pt. dus
H Zuhanycső tartó
E Grifo para ducha

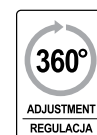

FALA

No.		
75537		100

PL Uchwyt do słuchawki prysznicowej
GB Shower holder
D Brauseporter
RUS Держатель душ
CZ Držák s kloubem na sprchu
RO Suport pt. dus
H Zuhanycső tartó
E Grifo para ducha

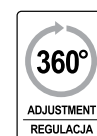

FALA

No.		
75564		50/200

- PL Uchwyt do słuchawki prysznicowej
- GB Shower holder
- D Brauseporfier
- RUS Держатель душ
- CZ Držák s kibom na sprchu
- RO Suport pt. dus
- H Zuhanycső tartó
- E Grifo para ducha



FALA

No.		
75565		30/180

- PL Wąż prysznicowy
- GB Shower hose
- D Brausenschlauch
- RUS Шланг для душа
- CZ Sprchová hadice
- RO Furtun duș
- H Zuhanycső
- E Manguera de ducha

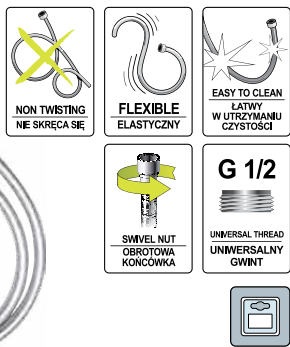

FALA

No.	L (m)	
75597	2.0	24

- PL Wąż prysznicowy
- GB Shower hose
- D Brausenschlauch
- RUS Шланг для душа
- CZ Sprchová hadice
- RO Furtun duș
- H Zuhanycső
- E Manguera de ducha

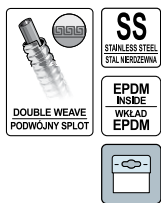

FALA

No.	L (m)	
75648	1.5	50
75649	2.0	50

- PL Wąż prysznicowy
- GB Shower hose
- D Brausenschlauch
- RUS Шланг для душа
- CZ Sprchová hadice
- RO Furtun duș
- H Zuhanycső
- E Manguera de ducha

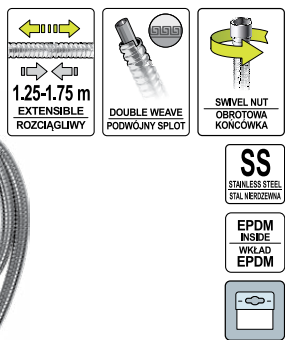

FALA

No.	L (m)	
75650	1.25 - 1.7	50

- PL Wąż prysznicowy
- GB Shower hose
- D Brausenschlauch
- RUS Шланг для душа
- CZ Sprchová hadice
- RO Furtun duș
- H Zuhanycső
- E Manguera de ducha

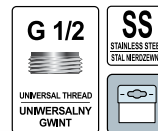

FALA

No.	L (m)	
75553	1.5	30/60
75554	1.7	30/60

- PL Wąż prysznicowy
- GB Shower hose
- D Brausenschlauch
- RUS Шланг для душа
- CZ Sprchová hadice
- RO Furtun duș
- H Zuhanycső
- E Manguera de ducha



FALA

No.	L (m)	
75578	1.5	30/60
75579	1.7	30/60

- PL Wąż prysznicowy
- GB Shower hose
- D Brausenschlauch
- RUS Шланг для душа
- CZ Sprchová hadice
- RO Furtun duș
- H Zuhanycső
- E Manguera de ducha

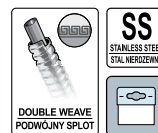

FALA

No.	L (m)	
75645	1.5	50
75646	1.75	50
75647	2.0	50

- PL Wąż prysznicowy
- GB Shower hose
- D Brausenschlauch
- RUS Шланг для душа
- CZ Sprchová hadice
- RO Furtun duș
- H Zuhanycső
- E Manguera de ducha

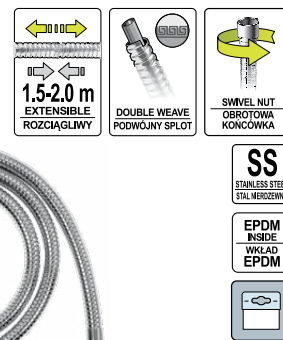

FALA

No.	L (m)	
75651	1.5 - 2.0	50

- PL Wąż przyszniciowy
GB Shower hose
D Brausenschlauch
RUS Шланг для душа
- CZ Sprchová hadice
RO Furtun duș
H Zuhanycső
E Manguera de ducha

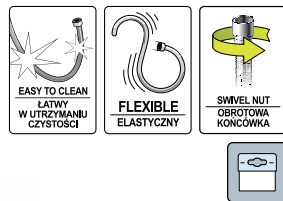

FALA

No.	L (m)	☐
75652	1.5	50
75653	2.0	50

- PL Wąż przyłączeniowy elastyczny
GB Flexible connecting hose
D Edelstahl Flexschlauch
RUS Гибкий шланг для смесителя
CZ Flexibilní nerezové hadice na vodu
RO Racorduri flexibile pt. apa
H Rugalmas rozsdamentes acél cső a víz
E Manguera flexible de acero inoxidable para el agua

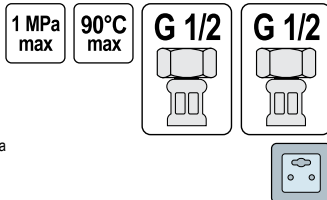

FALA

No.	L (mm)	☐
71800	300	180
71801	400	150
71802	500	120
71803	600	120
71804	800	100
71805	1000	80

- PL Wąż przyłączeniowy elastyczny
GB Flexible connecting hose
D Edelstahl Flexschlauch
RUS Гибкий шланг для смесителя
CZ Flexibilní nerezové hadice na vodu
RO Racorduri flexibile pt. apa
H Rugalmas rozsdamentes acél cső a víz
E Manguera flexible de acero inoxidable para el agua

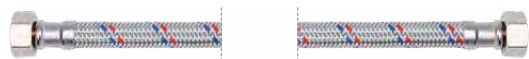
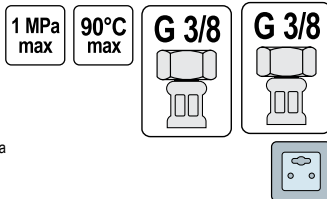

FALA

No.	L (mm)	☐
71814	300	250
71815	400	200
71816	500	150
71817	600	120
71818	800	100
71819	1000	80

- PL Wąż przyszniciowy
GB Shower hose
D Brausenschlauch
RUS Шланг для душа
- CZ Sprchová hadice
RO Furtun duș
H Zuhanycső
E Manguera de ducha

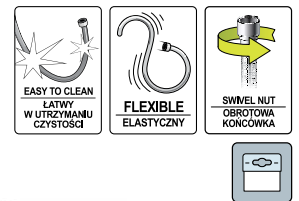

FALA

No.	L (m)	☐
75654	1.5	50
75655	2.0	50

- PL Wąż przyłączeniowy elastyczny
GB Flexible connecting hose
D Edelstahl Flexschlauch
RUS Гибкий шланг для смесителя
CZ Flexibilní nerezové hadice na vodu
RO Racorduri flexibile pt. apa
H Rugalmas rozsdamentes acél cső a víz
E Manguera flexible de acero inoxidable para el agua

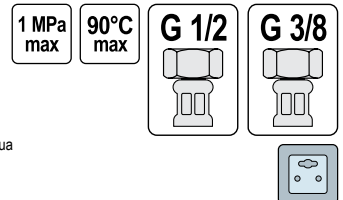

FALA

No.	L (mm)	☐
71807	300	200
71808	400	150
71809	500	120
71810	600	100
71811	800	100
71812	1000	80

- PL Wąż przyłączeniowy elastyczny
GB Flexible connecting hose
D Edelstahl Flexschlauch
RUS Гибкий шланг для смесителя
CZ Flexibilní nerezové hadice na vodu
RO Racorduri flexibile pt. apa
H Rugalmas rozsdamentes acél cső a víz
E Manguera flexible de acero inoxidable para el agua

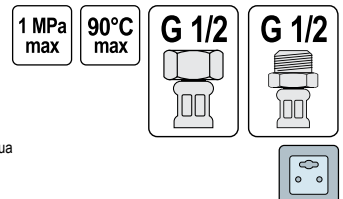

FALA

No.	L (mm)	☐
71820	300	10/250
71821	400	10/200
71822	500	100
71823	600	10/150
71824	800	10/100
71825	1000	10/80

PL Waż przyłączeniowy elastyczny
 GB Flexible connecting hose
 D Edelstahl Flexschlauch
 RUS Гибкий шланг для смесителя
 CZ Flexibilní nerezové hadice na vodu
 RO Racorduri flexibile pt. apa
 H Rugalmas rozsdamentes acél cső a víz
 E Manguera flexible de acero inoxidable para el agua

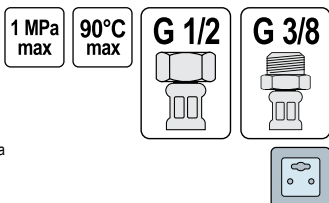

FALA

No.	L (mm)	
71827	300	10/300
71828	400	10/250
71829	500	10/200
71830	600	10/150
71831	800	10/100
71832	1000	10/80

PL Waż przyłączeniowy elastyczny
 GB Flexible connecting hose
 D Edelstahl Flexschlauch
 RUS Гибкий шланг для смесителя
 CZ Flexibilní nerezové hadice na vodu
 RO Racorduri flexibile pt. apa
 H Rugalmas rozsdamentes acél cső a víz
 E Manguera flexible de acero inoxidable para el agua

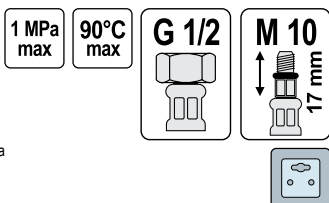

FALA

No.	L (mm)	
71840	300	10/300
71841	400	200
71842	500	150
71843	600	120
71844	800	10/100

PL Waż przyłączeniowy elastyczny
 GB Flexible connecting hose
 D Edelstahl Flexschlauch
 RUS Гибкий шланг для смесителя
 CZ Flexibilní nerezové hadice na vodu
 RO Racorduri flexibile pt. apa
 H Rugalmas rozsdamentes acél cső a víz
 E Manguera flexible de acero inoxidable para el agua

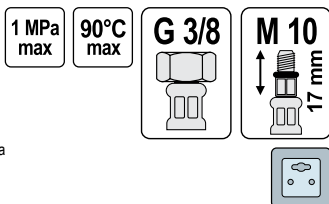

FALA

No.	L (mm)	
71851	300	250
71852	400	150
71853	500	150
71854	600	120
71855	800	100

PL Waż przyłączeniowy elastyczny
 GB Flexible connecting hose
 D Edelstahl Flexschlauch
 RUS Гибкий шланг для смесителя
 CZ Flexibilní nerezové hadice na vodu
 RO Racorduri flexibile pt. apa
 H Rugalmas rozsdamentes acél cső a víz
 E Manguera flexible de acero inoxidable para el agua

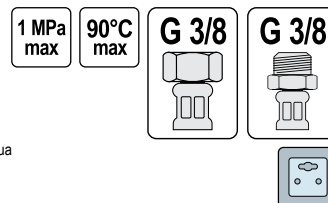

FALA

No.	L (mm)	
71833	300	250
71834	400	200
71835	500	200
71836	600	120
71837	800	100
71838	1000	80

PL Waż przyłączeniowy elastyczny
 GB Flexible connecting hose
 D Edelstahl Flexschlauch
 RUS Гибкий шланг для смесителя
 CZ Flexibilní nerezové hadice na vodu
 RO Racorduri flexibile pt. apa
 H Rugalmas rozsdamentes acél cső a víz
 E Manguera flexible de acero inoxidable para el agua

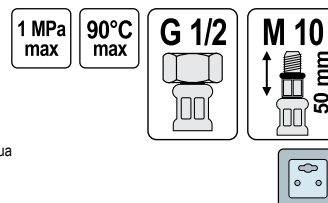

FALA

No.	L (mm)	
71846	300	10/300
71847	400	200
71848	500	150
71849	600	120
71850	800	100

PL Waż przyłączeniowy elastyczny
 GB Flexible connecting hose
 D Edelstahl Flexschlauch
 RUS Гибкий шланг для смесителя
 CZ Flexibilní nerezové hadice na vodu
 RO Racorduri flexibile pt. apa
 H Rugalmas rozsdamentes acél cső a víz
 E Manguera flexible de acero inoxidable para el agua

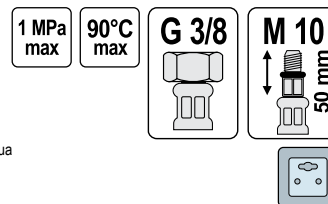

FALA

No.	L (mm)	
71856	300	200
71857	400	250
71858	500	150
71859	600	120
71860	800	100

- PL Zestaw łazienkowy
- GB Bathroom set
- D Brausegarnitur
- RUS Набор для душевой
- CZ Sprchová souprava
- RO Set pt. dus
- H Zuhanyzó készlet
- E Juego de bano ducha



FALA

No.	
75555	12

- PL Zestaw łazienkowy
- GB Bathroom set
- D Brausegarnitur
- RUS Набор для душевой
- CZ Sprchová souprava
- RO Set pt. dus
- H Zuhanyzó készlet
- E Juego de bano ducha



FALA

No.	
75558	12

- PL Zestaw łazienkowy
- GB Bathroom set
- D Brausegarnitur
- RUS Набор для душевой
- CZ Sprchová souprava
- RO Set pt. dus
- H Zuhanyzó készlet
- E Juego de bano ducha



FALA

No.	
75660	5

- PL Zestaw łazienkowy
- GB Bathroom set
- D Brausegarnitur
- RUS Набор для душевой
- CZ Sprchová souprava
- RO Set pt. dus
- H Zuhanyzó készlet
- E Juego de bano ducha



FALA

No.	
75556	12

- PL Zestaw łazienkowy
- GB Bathroom set
- D Brausegarnitur
- RUS Набор для душевой
- CZ Konzole na sprchu
- RO Suport dus
- H Zuhanytartó rúd
- E Carril de ducha



FALA

No.	
75559	16

- PL Zestaw łazienkowy
- GB Bathroom set
- D Brausegarnitur
- RUS Набор для душевой
- CZ Sprchová souprava
- RO Set pt. dus
- H Zuhanyzó készlet
- E Juego de bano ducha



FALA

No.	
75661	5

- PL Panel prysznicowy
- GB Shower panel
- D Hydromassageduschpaneel
- RUS Гидромассажная панель
- CZ Hydromasážní panel
- RO Panou de hidromasaj
- H Hidromassázs panel
- E Columna de hidromasaje



FALA

No.
75980

1

- PL Panel prysznicowy
- GB Shower panel
- D Hydromassageduschpaneel
- RUS Гидромассажная панель
- CZ Hydromasážní panel
- RO Panou de hidromasaj
- H Hidromassázs panel
- E Columna de hidromasaje



FALA

No.
75981

1

- PL Panel prysznicowy
- GB Shower panel
- D Hydromassageduschpaneel
- RUS Гидромассажная панель
- CZ Hydromasážní panel
- RO Panou de hidromasaj
- H Hidromassázs panel
- E Columna de hidromasaje



FALA

No.
75982

1

- PL Parawan nawannowy
- GB Bathtub screen
- D Badewannenabtrennung
- RUS Штора для ванн

- CZ Vanová zástěna
- RO Paravan pt. duș
- H Kádparavánok
- E Mampara de bañera

80x140
cm

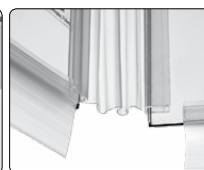

FALA

No.
68621

1

PL Parawan nawannowy CZ Vanová zástěna
 GB Bathtub screen RO Paravan pt. duș
 D Badewannenabtrennung H Kádparavánok
 RUS Штора для ванн E Mampara de bañera



FALA

No.
68622



PL Haczyk pojedynczy CZ Háček
 GB Robe hook RO Agatatoare simpla
 D Einzelhaken H Fali akasztó
 RUS Крючок одинарный E Perchero de pared



FALA

No.
69300

series / seria
OVAL CHROM



PL Mydelniczka CZ Mýdelnička
 GB Soap dish RO Sapuniera
 D Seifenschale H Szappantartó táj
 RUS Мыльница E Jabonera



FALA

No.
69302

series / seria
OVAL CHROM



PL Parawan nawannowy CZ Vanová zástěna
 GB Bathtub screen RO Paravan pt. duș
 D Badewannenabtrennung H Kádparavánok
 RUS Штора для ванн E Mampara de bañera



FALA

No.
68623



PL Kubek kosmetyczny CZ Dóza
 GB Tumbler RO Suport periuță
 D Becher H Fürdőszobai pohár
 RUS Стакан E Vaso



FALA

No.
69301

series / seria
OVAL CHROM



PL Uchwyt na papier toaletowy CZ Držák na toaletní papír
 GB Toilet paper holder RO Porhartie
 D WC Papierhalter H WC papír tartó
 RUS Держатель для туалетной бумаги без крышек E Portarrollos para papel higiénico



FALA

No.
69303

series / seria
OVAL CHROM



- PL Uchwyt na papier toaletowy
GB Toilet paper holder
D WC Papierhalter
RUS Держатель для туалетной бумаги без крышек
- CZ Držák na toaletní papír
RO Porthartie
H WC papír tartó
E Portarrollos para papel higiénico



FALA

No.	series / seria	Icon
69304	OVAL CHROM	6/24

- PL Uchwyt na ręcznik
GB Towel ring
D Handtuchring
RUS Кольцо для полотенца
- CZ Držák ručníků
RO Portprosop
H Törölközőtartó
E Toallero anillo



FALA

No.	series / seria	Icon
69306	OVAL CHROM	4/24

- PL Półka szklana
GB Glass shelf
D Ablagekonsole aus Glas
RUS Этажерка настенная
CZ Polička do koupelny
RO Polița sticlă
H Piperepolc - üveg
E Estante



FALA

No.	series / seria	Icon
69308	OVAL CHROM	4/8

- PL Kubek kosmetyczny
GB Tumbler
D Becher
RUS Стакан
- CZ Dóza
RO Suport periuță
H Fürdőszobai pohár
E Vaso



FALA

No.	series / seria	Icon
69312	QUAD CHROM	4/24

- PL Uchwyt na ręcznik
GB Towel ring
D Handtuchring
RUS Кольцо для полотенца
- CZ Držák ručníků
RO Portprosop
H Törölközőtartó
E Toallero anillo



FALA

No.	series / seria	Icon
69305	OVAL CHROM	5/30

- PL Szczotka WC
GB Toilet brush holder
D WC - Garnitur
RUS Туалетная щетка настенная
CZ WC štětka
RO Suport perie WC
H WC kefe
E Escobillero mura



FALA

No.	series / seria	Icon
69307	OVAL CHROM	4/8

- PL Haczyk pojedynczy
GB Robe hook
D Einzelhaken
RUS Крючок одинарный
- CZ Háček
RO Agatatoare simplă
H Falli akasztó
E Perchero de pared



FALA

No.	series / seria	Icon
69311	QUAD CHROM	6/72

- PL Mydelniczka
GB Soap dish
D Seifenschale
RUS Мыльница
- CZ Mýdelnička
RO Sapuniera
H Szappantartó tál
E Jabonera



FALA

No.	series / seria	Icon
69313	QUAD CHROM	4/24

PL Uchwyt na papier toaletowy
GB Toilet paper holder
D WC Papierhalter
RUS Держатель для туалетной бумаги без крышки



FALA

No.	series / seria	Icon
69314	QUAD CHROM	4/24

PL Uchwyt na zapasowy papier
GB Toilet paper holder
D Reserverpapierhalter
RUS Держатель для запасного рулона туалетной

CZ Držák na toaletní papír
RO Porthartie
H WC papír tartó
E Portarrollos para papel higiénico



FALA

No.	series / seria	Icon
69316	QUAD CHROM	5/30

PL Uchwyt na ręcznik
GB Towel ring
D Handtuchring
RUS Кольцо для полотенца

CZ Držák ručníků
RO Portprosop
H Törölközőtartó
E Toallero anillo



FALA

No.	series / seria	Icon
69318	QUAD CHROM	4/24

PL Szczotka WC
GB Toilet brush holder
D WC - Garnitur
RUS Туалетная щетка настенная
CZ WC štětka
RO Suport perie WC
H WC kefe
E Escobillero mura



FALA

No.	series / seria	Icon
69320	QUAD CHROM	4/8

PL Uchwyt na papier toaletowy
GB Toilet paper holder
D WC Papierhalter
RUS Держатель для туалетной бумаги без крышки



FALA

No.	series / seria	Icon
69315	QUAD CHROM	4/24

PL Uchwyt na ręcznik
GB Towel ring
D Handtuchring
RUS Кольцо для полотенца
CZ Držák ručníků
RO Portprosop
H Törölközőtartó
E Toallero anillo



FALA

No.	series / seria	Icon
69317	QUAD CHROM	4/24

PL Uchwyt na ręcznik
GB Towel ring
D Handtuchring
RUS Кольцо для полотенца

CZ Držák ručníků
RO Portprosop
H Törölközőtartó
E Toallero anillo



FALA

No.	series / seria	Icon
69319	QUAD CHROM	4/24

PL Półka szklana
GB Glass shelf
D Ablagekonsole aus Glas
RUS Этажерка настенная
CZ Polička do koupelny
RO Polita sticla
H Piperepolc - üveg
E Estante



FALA

No.	series / seria	Icon
69321	QUAD CHROM	4/8

PL Kubek kosmetyczny
GB Tumbler
D Becher
RUS Стакан
CZ Dóza
RO Suport periută
H Fűrdőszobai pohár
E Vaso



FALA

No.	series / seria	
69330	TIER	6/120

PL Mydelniczka
GB Soap dish
D Seifenschale
RUS Мыльница

CZ Mýdelnička
RO Sapuniera
H Szappantartó tál
E Jabonera



FALA

No.	series / seria	
69332	TIER	6/144

PL Szczotka WC
GB Toilet brush holder
D Wc-Bürste
RUS Щетка туалетная
CZ WC kartáč
RO Perie WC
H WC kefe tartó
E Escobillero



FALA

No.	series / seria	
69334	TIER	6/24

PL Kubek na szczoteczki do zębów
GB Toothbrush holder
D Zahnputzbecher
RUS Стакан для зубных щеток

CZ Dóza na zubní kartáčky
RO Suport pt. periute dinti
H Fogkefektartó pohár
E Portacepillós



FALA

No.	series / seria	
69338	CUBOID WHITE	6/72

PL Kubek na szczoteczki do zębów
GB Toothbrush holder
D Zahnputzbecher
RUS Стакан для зубных щеток

CZ Dóza na zubní kartáčky
RO Suport pt. periute dinti
H Fogkefektartó pohár
E Portacepillós



FALA

No.	series / seria	
69331	TIER	6/120

PL Dozownik mydła w płynie
GB Lotion dispenser
D Seifenspender
RUS Дозатор для жидкого мыла
CZ Dávkovač mýdla
RO Dozator sapun
H Folyékony szappan adagoló
E Dosificador



FALA

No.	series / seria	
69333	TIER	6/96

PL Kubek kosmetyczny
GB Tumbler
D Becher
RUS Стакан
CZ Dóza
RO Suport periută
H Fűrdőszobai pohár
E Vaso



FALA

No.	series / seria	
69337	CUBOID WHITE	6/144

PL Mydelniczka
GB Soap dish
D Seifenschale
RUS Мыльница

CZ Mýdelnička
RO Sapuniera
H Szappantartó tál
E Jabonera



FALA

No.	series / seria	
69339	CUBOID WHITE	6/144

PL Dozownik mydła w płynie
GB Lotion dispenser
D Seifenspender
RUS Дозатор для жидкого мыла
CZ Dávkovač mýdla
RO Dozator sapun
H Folyékony szappan adagoló
E Dosificador



FALA

No.	series / seria	
69340	CUBOID WHITE	6/72

PL Kubek kosmetyczny
GB Tumbler
D Becher
RUS Стакан

CZ Dóza
RO Suport periuță
H Fürdőszobai pohár
E Vaso



FALA

No.	series / seria	
69344	CUBOID BEIGE	6/144

PL Mydelniczka
GB Soap dish
D Seifenschale
RUS Мыльница

CZ Mýdelnička
RO Sapuniera
H Szappantartó tál
E Jabonera



FALA

No.	series / seria	
69346	CUBOID BEIGE	6/144

PL Szczotka WC
GB Toilet brush holder
D Wc-Bürste
RUS Щетка туалетная
CZ WC kartáč
RO Perie WC
H WC kefe tartó
E Escobillero



FALA

No.	series / seria	
69348	CUBOID BEIGE	6/48

PL Szczotka WC
GB Toilet brush holder
D Wc-Bürste
RUS Щетка туалетная
CZ WC kartáč
RO Perie WC
H WC kefe tartó
E Escobillero



FALA

No.	series / seria	
69341	CUBOID WHITE	6/48

PL Kubek na szczoteczki do zębów
GB Toothbrush holder
D Zahnputzbecher
RUS Стакан для зубных щеток

CZ Dóza na zubní kartáčky
RO Suport pt. periuțe dinții
H Fogkefetartó pohár
E Portacepillós



FALA

No.	series / seria	
69345	CUBOID BEIGE	6/72

PL Dozownik mydła w płynie
GB Lotion dispenser
D Seifenspender
RUS Дозатор для жидкого мыла
CZ Dávkovač mýdla
RO Dozator sapun
H Folyékony szappan adagoló
E Dosificador



FALA

No.	series / seria	
69347	CUBOID BEIGE	6/72

PL Kubek kosmetyczny
GB Tumbler
D Becher
RUS Стакан

CZ Dóza
RO Suport periuță
H Fürdőszobai pohár
E Vaso



FALA

No.	series / seria	
69350	NICKEL	6/96

- PL Kubek na szczoteczki do zębów
 GB Toothbrush holder
 D Zahnputzbecher
 RUS Стакан для зубных щеток
- CZ Dóza na zubní kartáčky
 RO Suport pt. periuțe dinti
 H Fogkefelartó pohár
 E Portacepillos



FALA

No.	series / seria	
69351	NICKEL	6/96

- PL Dozownik mydła w płynie
 GB Lotion dispenser
 D Seifenspender
 RUS Дозатор для жидкого мыла
 CZ Dávkovač mydla
 RO Dozator sapun
 H Folyékony szappan adagoló
 E Dosificador



FALA

No.	series / seria	
69353	NICKEL	6/72

- PL Kubek kosmetyczny
 GB Tumbler
 D Becher
 RUS Стакан
- CZ Dóza
 RO Suport periută
 H Fürdőszobai pohár
 E Vaso



FALA

No.	series / seria	
69357	WAVE	6/60

- PL Kubek na waciki
 GB Cotton box wave
 D Wattdose
 RUS Емкость косметическая
- CZ Dóza kosmetická
 RO Suport dischete demachiant
 H Fürdőszobai pohár
 E Vaso



FALA

No.	series / seria	
69359	WAVE	6/48

- PL Mydelniczka
 GB Soap dish
 D Seifenschale
 RUS Мыльница
- CZ Mýdelnička
 RO Sapuniara
 H Szappantartó tál
 E Jabonera



FALA

No.	series / seria	
69352	NICKEL	6/192

- PL Szczotka WC
 GB Toilet brush holder
 D Wc-Bürste
 RUS Щетка туалетная
 CZ WC kartáč
 RO Perie WC
 H WC kefe tartó
 E Escobillero



FALA

No.	series / seria	
69354	NICKEL	6/24

- PL Kubek na szczoteczki do zębów
 GB Toothbrush holder
 D Zahnputzbecher
 RUS Стакан для зубных щеток
- CZ Dóza na zubní kartáčky
 RO Suport pt. periuțe dinti
 H Fogkefelartó pohár
 E Portacepillos



FALA

No.	series / seria	
69358	WAVE	6/60

- PL Mydelniczka
 GB Soap dish
 D Seifenschale
 RUS Мыльница
- CZ Mýdelnička
 RO Sapuniara
 H Szappantartó tál
 E Jabonera



FALA

No.	series / seria	
69360	WAVE	6/144

- PL Dozownik mydła w płynie
- GB Lotion dispenser
- D Seifenspender
- RUS Дозатор для жидкого мыла
- CZ Dávkačč mydla
- RO Dozator sapun
- H Folyékony szappan adagoló
- E Dosificador



FALA

No.	series / seria	Icon
69361	WAVE	6/48

- PL Szczotka WC wysoka
- GB Toilet brush holder long
- D Wc-Bürste
- RUS Щетка туалетная
- CZ WC kartáč
- RO Perie WC
- H WC kefe tartó
- E Escobillero



FALA

No.	series / seria	Icon
69363	WAVE L	6/12

- PL Haczyk pojedynczy
- GB Robe hook
- D Einzelhaken
- RUS Крючок одинарный
- CZ Háček
- RO Agatatoare simpla
- H Fall akasztó
- E Perchero de pared



FALA

No.	series / seria	Icon
69371	STEELY	330

- PL Haczyk podwójny
- GB Robe hook
- D Einzelhaken
- RUS Крючок одинарный
- CZ Háček
- RO Agatatoare simpla
- H Fall akasztó
- E Perchero de pared



FALA

No.	series / seria	Icon
69373	STEELY	220

- PL Szczotka WC
- GB Toilet brush holder short
- D Wc-Bürste
- RUS Щетка туалетная
- CZ WC kartáč
- RO Perie WC
- H WC kefe tartó
- E Escobillero



FALA

No.	series / seria	Icon
69362	WAVE S	6/36

- PL Haczyk pojedynczy
- GB Robe hook
- D Einzelhaken
- RUS Крючок одинарный
- CZ Háček
- RO Agatatoare simpla
- H Fall akasztó
- E Perchero de pared



FALA

No.	series / seria	Icon
69370	STEELY	165

- PL Haczyk podwójny
- GB Robe hook
- D Einzelhaken
- RUS Крючок одинарный
- CZ Háček
- RO Agatatoare simpla
- H Fall akasztó
- E Perchero de pared



FALA

No.	series / seria	Icon
69372	STEELY	110

- PL Uchwyt na ręcznik
- GB Towel ring
- D Handtuchring
- RUS Кольцо для полотенца
- CZ Držák ručníků
- RO Porțprosop
- H Törölközőtartó
- E Toallero anillo



FALA

No.	series / seria	Icon
69374	STEELY	25

- PL Uchwyt na papier toaletowy
- GB Toilet paper holder
- D WC Papierhalter
- RUS Держатель для туалетной бумаги без крышки
- CZ Držák na toaletní papír
- RO Porthartie
- H WC papír tartó
- E Portarrollos para papel higiénico



FALA

No.	series / seria	☐
69375	STEELY	50

- PL Półka
- GB Shelf
- D Ablagekonsole
- RUS Этажерка настенная
- CZ Polička do koupelny
- RO Polita
- H Piperepolc
- E Estante



FALA

No.	series / seria	☐
69377	STEELY	30

- PL Organizer na kosmetyki
- GB Cosmetic organizer
- D Kosmetik Organizer
- RUS Органайзер для косметики
- CZ Kosmetický organizér
- RO Organizator cosmetice
- H Kosmetikai vagy ékszer szervező
- E Organizador cosmética



FALA

No.	series / seria	☐
69400	CRYSTAL 1	72

- PL Organizer na kosmetyki
- GB Cosmetic organizer
- D Kosmetik Organizer
- RUS Органайзер для косметики
- CZ Kosmetický organizér
- RO Organizator cosmetice
- H Kosmetikai vagy ékszer szervező
- E Organizador cosmética



FALA

No.	series / seria	☐
69402	CRYSTAL 3	24

- PL Uchwyt na ręcznik haczyk
- GB Towel rail robe hook
- D Badetuchstange Einzelhaken
- RUS Вешалка для полотенца крючок одинарный
- CZ Držák ručníků háček
- RO Portprosop ag atatoare simpla
- H Törölközőtartó akasztó
- E Toallero anillo perchero de pared



FALA

No.	series / seria	☐
69376	STEELY	20

- PL Półka
- GB Shelf
- D Ablagekonsole
- RUS Этажерка настенная
- CZ Polička do koupelny
- RO Polita
- H Piperepolc
- E Estante



FALA

No.	series / seria	☐
69378	STEELY	30

- PL Organizer na kosmetyki
- GB Cosmetic organizer
- D Kosmetik Organizer
- RUS Органайзер для косметики
- CZ Kosmetický organizér
- RO Organizator cosmetice
- H Kosmetikai vagy ékszer szervező
- E Organizador cosmética



FALA

No.	series / seria	☐
69401	CRYSTAL 2	72

- PL Organizer na kosmetyki
- GB Cosmetic organizer
- D Kosmetik Organizer
- RUS Органайзер для косметики
- CZ Kosmetický organizér
- RO Organizator cosmetice
- H Kosmetikai vagy ékszer szervező
- E Organizador cosmética



FALA

No.	series / seria	☐
69403	CRYSTAL 4	24

PL Organizator na kosmetyki
GB Cosmetic organizer
D Kosmetik Organizer
RUS Органайзер для косметики
CZ Kosmetický organizér
RO Organizator cosmetice
H Kosmetikai vagy ékszer szervező
E Organizador cosmética



FALA

No.	series / seria	
69404	CRYSTAL 5	12

PL Organizator na kosmetyki
GB Cosmetic organizer
D Kosmetik Organizer
RUS Органайзер для косметики
CZ Kosmetický organizér
RO Organizator cosmetice
H Kosmetikai vagy ékszer szervező
E Organizador cosmética



FALA

No.	series / seria	
69406	CRYSTAL 7	12

PL Organizator na kosmetyki
GB Cosmetic organizer
D Kosmetik Organizer
RUS Органайзер для косметики

CZ Kosmetický organizér
RO Organizator cosmetice
H Kosmetikai vagy ékszer szervező
E Organizador cosmética

FALA

No.	series / seria	
69408	CRYSTAL 9	12

PL Deska sedesowa
GB Toilet seat
D WC Deckel
RUS Сиденье для унитаза
CZ WC sedátko
RO Capac WC
H WC-tülökke
E Asiento de inodoro

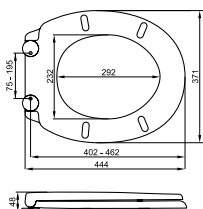
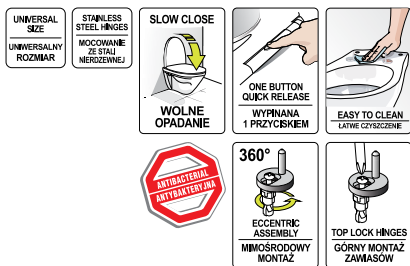

FALA

No.		
75465		5

PL Organizator na kosmetyki
GB Cosmetic organizer
D Kosmetik Organizer
RUS Органайзер для косметики
CZ Kosmetický organizér
RO Organizator cosmetice
H Kosmetikai vagy ékszer szervező
E Organizador cosmética



FALA

No.	series / seria	
69405	CRYSTAL 6	12

PL Organizator na kosmetyki
GB Cosmetic organizer
D Kosmetik Organizer
RUS Органайзер для косметики
CZ Kosmetický organizér
RO Organizator cosmetice
H Kosmetikai vagy ékszer szervező
E Organizador cosmética



FALA

No.	series / seria	
69407	CRYSTAL 8	12

PL Organizator na kosmetyki
GB Cosmetic organizer
D Kosmetik Organizer
RUS Органайзер для косметики



PL Deska sedesowa
GB Toilet seat
D WC Deckel
RUS Сиденье для унитаза
CZ WC sedátko
RO Capac WC
H WC-tülökke
E Asiento de inodoro

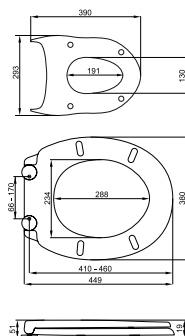
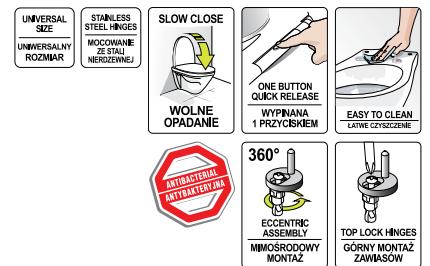

FALA

No.		
75467		5

- PL Deska sedesowa
- GB Toilet seat
- D WC Deckel
- RUS Сиденье для унитаза
- CZ WC sedátko
- RO Capac WC
- H WC-ülöke
- E Asiento de inodoro

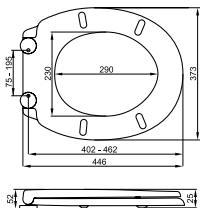
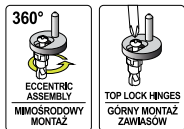

FALA

No. 75468

5

- PL Deska sedesowa
- GB Toilet seat
- D WC Deckel
- RUS Сиденье для унитаза
- CZ WC sedátko
- RO Capac WC
- H WC-ülöke
- E Asiento de inodoro

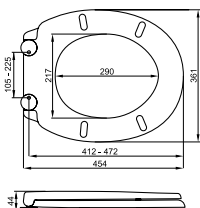
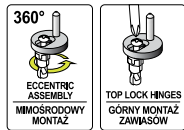

FALA

No. 75464

5

- PL Lampka LED do podświetlania WC
- GB LED toilet light
- D WC LED Lampe
- RUS LED ночник для туалета
- CZ WC LED světlo
- RO Lumină pt. toaletă
- H LED WC megvilágítás
- E WC LED lámpara



RGB LED



FALA

No. 75455

100

- PL Deska sedesowa
- GB Toilet seat
- D WC Deckel
- RUS Сиденье для унитаза
- CZ WC sedátko
- RO Capac WC
- H WC-ülöke
- E Asiento de inodoro

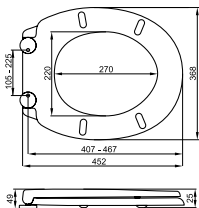
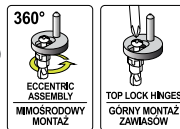

FALA

No. 75469

5

- PL Deska sedesowa
- GB Toilet seat
- D WC Deckel
- RUS Сиденье для унитаза
- CZ WC sedátko
- RO Capac WC
- H WC-ülöke
- E Asiento de inodoro



FALA

No. 75470

6

- PL Miska WC tip rimless z deską slim duropi
- GB Wall hung toilet tip rimless incl. seat
- D Toiletenschüssel
- RUS Унитаз подвесной
- CZ WC závěsný
- RO WC suspendat
- H WC fűhő
- E Inodoro



FALA

No. 68800

1

PL Miska WC tip rimless z deską slim duropl
 GB Wall hung toilet tip rimless incl. seat
 D Toilettenschüssel
 RUS Унитаз подвесной

CZ WC závěsný
 RO WC suspendat
 H WC fűér
 E Inodoro



FALA

No.		
68801		1

PL Umywalka nabladowa
 GB Basin
 D Waschbecken
 RUS Умывальник

CZ Umyvadlo
 RO Chiuveta
 H Mosdó
 E Lavabo



FALA

No.	series / seria	
68830	TIP	1

PL Umywalka nabladowa
 GB Basin
 D Waschbecken
 RUS Умывальник

CZ Umyvadlo
 RO Chiuveta
 H Mosdó
 E Lavabo



FALA

No.	series / seria	
68832	TOP	1

PL Umywalka nabladowa
 GB Basin oval
 D Waschbecken
 RUS Умывальник

CZ Umyvadlo
 RO Chiuveta
 H Mosdó
 E Lavabo



FALA

No.	series / seria	
68820	OVAL	1

PL Umywalka nabladowa
 GB Basin
 D Waschbecken
 RUS Умывальник

CZ Umyvadlo
 RO Chiuveta
 H Mosdó
 E Lavabo

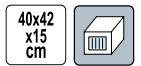

FALA

No.	series / seria	
68831	TOP	1

PL Umywalka nabladowa
 GB Basin
 D Waschbecken
 RUS Умывальник

CZ Umyvadlo
 RO Chiuveta
 H Mosdó
 E Lavabo

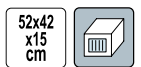

FALA

No.	series / seria	
68833	TOP	1

Weight/BMI – The Body Mass Index (BMI), defined as the body mass divided by the body height, is a quantification for categorizing human weight and health status



WEIGHT

Wskaźnik Masy Ciała - The Body Mass Index (BMI), definiuje się jako wartość masy ciała podzieloną przez kwadrat wzrostu, jest to wartość używana do klasyfikowania ludzkiej wagi i stanu zdrowia.

Weight/BMI – The Body Mass Index (BMI), defined as the body mass divided by the body height, is a quantification for categorizing human weight and health status.



BMI

Wskaźnik masy ciała - Body Mass Index (BMI), definiuje się jako wartość masy ciała podzieloną przez kwadrat wzrostu; jest to wartość używana do klasyfikowania ludzkiej wagi i stanu zdrowia.

Metabolism – Basal Metabolic Rate (BMR) is the minimal rate of energy expenditure unit time by human at rest, expressed in calories. It was measured under the circumstances when a man is awake and at complete rest.



BMR

Wskaźnik podstawowej przemiany materii - Basal Metabolic Rate (BMR) to minimalna ilość energii wyrażona w kaloriach, potrzebna do funkcjonowania organizmu w czasie odpoczynku.

Fat percentage is the total mass of fat divided by total body mass. It provides a better assessment for how fat or thin person is compared to BMI.



FAT

Procent tłuszczu ciała to całkowita masa tłuszczu podzielona przez całkowitą masę ciała; wskaźnik tłuszczu ciała odnosi się do niezbędnego tłuszczu i metabolizmu.

Body water percentage is closely related to body muscle mass, since muscle contains a large amount of water (approx. 70%).



WATER

Procent wody w organizmie jest ściśle związany z masą mięśniową, ponieważ mięśnie zawierają dużą ilość wody (ok. 70%).

Visceral Fat is fat stored within the abdominal cavity around a number of internal organs.



VISCERALfat

Tłuszcz trzewny to tłuszcz magazynowany w podbrzuszu wokół wielu narządów wewnętrznych.

Muscle mass index is calculated from muscle mass, body weight and height. It is a quantitative assessment of health status and strength.



MUSCLE

Wskaźnik masy mięśniowej jest wyliczany na podstawie masy mięśni, wagi ciała i wzrostu. To ilościowe rozumienie stanu zdrowia i siły.

Ludzki szkielet, składający się z kości, podtrzymuje ludzkie ciało. Gęstość kości i utrata wapnia to główne problemy dla zdrowia kości.

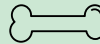

BONES

Bone Mass – The human skeleton, composed of bones, supports the human body. Bone mineral density and calcium loss are the main concerns for bone health.

- PL Waga łazienkowa
- GB Bathroom scale
- D Personenwaage
- RUS Ванная шкала
- CZ Váha do koupelny
- RO Cantar baie
- H Személymérleg
- E Bascula de baño

3-180 kg 6,6-396 lb	LCD DISPLAY WYŚWIETLACZ LCD
280x280 mm TEMPERED GLASS SZKŁO HARTOWANE	AUTO ZERO AUTOMATYCZNE KALIBROWANIE
AUTO POWER ON/OFF AUTOMATYCZNE WYŁĄCZANIE	OVERLOAD DETECTOR WSKAŹNIK PRZEŁĄCZENIA
LOW BATTERY INDICATOR WSKAŹNIK NISKIEGO POZOMU BATERII	4. 4-SEGMENT HIGH-RESOLUTION TECHNOLOGY
POWER: ZASILANIE 3V 2xAAA BATERIE WŁĄCZANE BATERIE NIE DOŁĄCZONE	kg/lb/st



FALA

No.
69201



- PL Waga łazienkowa
- GB Bathroom scale
- D Personenwaage
- RUS Ванная шкала
- CZ Váha do koupelny
- RO Cantar baie
- H Személymérleg
- E Bascula de baño

3-180 kg 6,6-396 lb	LCD DISPLAY WYŚWIETLACZ LCD
300x300 mm TEMPERED GLASS SZKŁO HARTOWANE	AUTO ZERO AUTOMATYCZNE KALIBROWANIE
AUTO POWER ON/OFF AUTOMATYCZNE WYŁĄCZANIE	OVERLOAD DETECTOR WSKAŹNIK PRZEŁĄCZENIA
LOW BATTERY INDICATOR WSKAŹNIK NISKIEGO POZOMU BATERII	4. 4-SEGMENT HIGH-RESOLUTION TECHNOLOGY
POWER: ZASILANIE 6V 4xAAA BATERIE WŁĄCZANE BATERIE NIE DOŁĄCZONE	kg/lb/st

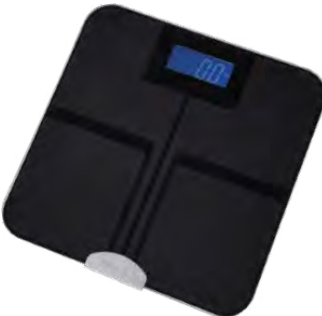

FALA

No.
69203



- PL Waga łazienkowa
- GB Bathroom scale
- D Personenwaage
- RUS Ванная шкала
- CZ Váha do koupelny
- RO Cantar baie
- H Személymérleg
- E Bascula de baño

3-180 kg 6,6-396 lb	LCD DISPLAY WYŚWIETLACZ LCD
280x280 mm TEMPERED GLASS SZKŁO HARTOWANE	AUTO ZERO AUTOMATYCZNE KALIBROWANIE
AUTO POWER ON/OFF AUTOMATYCZNE WYŁĄCZANIE	OVERLOAD DETECTOR WSKAŹNIK PRZEŁĄCZENIA
LOW BATTERY INDICATOR WSKAŹNIK NISKIEGO POZOMU BATERII	4. 4-SEGMENT HIGH-RESOLUTION TECHNOLOGY
POWER: ZASILANIE 3V 2xAAA BATERIE WŁĄCZANE BATERIE NIE DOŁĄCZONE	kg/lb/st

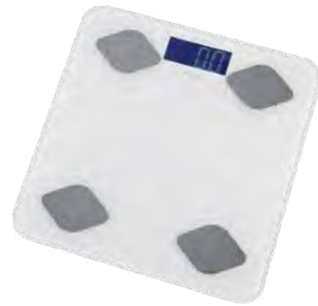

FALA

No.
69202



- PL Waga łazienkowa
- GB Bathroom scale
- D Personenwaage
- RUS Ванная шкала
- CZ Váha do koupelny
- RO Cantar baie
- H Személymérleg
- E Bascula de baño

3-180 kg 6,6-396 lb	LCD DISPLAY WYŚWIETLACZ LCD
300x300 mm TEMPERED GLASS SZKŁO HARTOWANE	AUTO ZERO AUTOMATYCZNE KALIBROWANIE
AUTO POWER ON/OFF AUTOMATYCZNE WYŁĄCZANIE	OVERLOAD DETECTOR WSKAŹNIK PRZEŁĄCZENIA
LOW BATTERY INDICATOR WSKAŹNIK NISKIEGO POZOMU BATERII	4. 4-SEGMENT HIGH-RESOLUTION TECHNOLOGY
POWER: ZASILANIE 6V 4xAAA BATERIE WŁĄCZANE BATERIE NIE DOŁĄCZONE	kg/lb/st



FALA

No.
69204



- PL Waga łazienkowa
- GB Bathroom scale
- D Personenwaage
- RUS Ванная шкала
- CZ Váha do koupelny
- RO Cantar baie
- H Személymérleg
- E Bascula de baño



3-180 kg 6.6-396 lb	LCD DISPLAY WYŚWIETLACZ LCD
280x280 mm TEMPERED GLASS SZCZYGARTOWANE	AUTO ZERO AUTOMATYCZNE KALIBROWANIE
AUTO POWER OFF AUTOMATYCZNE WYŁĄCZANIE WYŁĄCZANIE	OVERLOAD DETECTOR WSKAZNIK PRZEŁADUNIA
LOW BATTERY INDICATOR WSKAZNIK NISZKIEGO POZIOMU BATERII	4 2-LETNIA GWARANCJA NA PODZIAŁOWE KOMPONENTY
POWER / ZASILANIE 3V 2xAAA	kg/lb/st



No.		
69205		8

- PL Stolek plastikowy
- GB Plastic stool
- D Kunststoff Hocker
- RUS Пластиковый табурет
- CZ Plastová stolička
- RO Scaun de plastic
- H Müanyag székellet
- E Taburete de plástico



No.	size / rozmiar (cm)	
75915	30x20x21	10/20

- PL Pompa łazienkowa do pryszniców i umywalki
- GB Waste pump for shower and basin
- D Haushaltspumpe für Dusche und Waschtisch
- RUS Санитарный насос
- CZ Koupelnové čerpadlo pro sprchy
- RO Pompa pt. ape uzate - dus, lovoar
- H Szivattyú zuhanyzóhoz
- E Bomba de evacuación

220-240V~50Hz	250 W
Q max 80 l/min	4.0 m ↑
40°C max	40m →
IPX4	2x Ø 32 mm



No.	W	
75944	250	4

- PL Waga łazienkowa
- GB Bathroom scale
- D Personenwaage
- RUS Ванная шкала
- CZ Váha do koupelny
- RO Cantar baie
- H Személymérleg
- E Bascula de baño



3-180 kg 6.6-396 lb	LCD DISPLAY WYŚWIETLACZ LCD
280x280 mm TEMPERED GLASS SZCZYGARTOWANE	AUTO ZERO AUTOMATYCZNE KALIBROWANIE
AUTO POWER OFF AUTOMATYCZNE WYŁĄCZANIE WYŁĄCZANIE	OVERLOAD DETECTOR WSKAZNIK PRZEŁADUNIA
LOW BATTERY INDICATOR WSKAZNIK NISZKIEGO POZIOMU BATERII	4 2-LETNIA GWARANCJA NA PODZIAŁOWE KOMPONENTY
POWER / ZASILANIE 3V 2xAAA	kg/lb/st



No.		
69206		8

- PL Stolek plastikowy
- GB Plastic stool
- D Kunststoff Hocker
- RUS Пластиковый табурет
- CZ Plastová stolička
- RO Scaun de plastic
- H Müanyag székellet
- E Taburete de plástico



No.	size / rozmiar (cm)	
75916	30x20x21	10/20

- PL Pompa łazienkowa do pryszniców i umywalki
- GB Waste pump for shower and basin
- D Haushaltspumpe für Dusche und Waschtisch
- RUS Санитарный насос
- CZ Koupelnové čerpadlo pro sprchy
- RO Pompa pt. ape uzate - dus, lovoar
- H Szivattyú zuhanyzóhoz
- E Bomba de evacuación

220-240V~50Hz	250 W	Q max 100 l/min	Ø 25/32 mm 2x Ø 40 mm
5 m ↑	50°C max	IPX7	



No.	W	
75945	250	1

PL Pompa sanitarna z rozdrabniaczem
 GB Sewage lifting station with grinder
 D Kleinhebeanlage fäkalienhaltiges Abwasser
 RUS Канализационная насосная установка
 CZ Sanitární kalové čerpadlo
 RO Slatia pt. evacuarea apelor uzate
 H Átemelő szivattyú
 E Estación de levantamiento para aguas residuales

220-240V-50Hz
600 W
 Q max 140 l/min
6.5 m
90°C max
 3000 min⁻¹
IPX4
 Ø100 mm
 2x Ø 40 mm



FALA

No.	W	
75951	600	1

PL Pompa sanitarna z rozdrabniaczem
 GB Sewage lifting station with grinder
 D Kleinhebeanlage fäkalienhaltiges Abwasser
 RUS Канализационная насосная установка
 CZ Sanitární kalové čerpadlo
 RO Slatia pt. evacuarea apelor uzate
 H Átemelő szivattyú
 E Estación de levantamiento para aguas residuales

220-240V-50Hz
600 W
 Q max 150 l/min
9.5 m
45°C max
 2850 min⁻¹
IP55
 Ø100 mm
 2x Ø 40 mm



FALA

No.	W	
75953	600	1

Convenient and easy to use.

Wygodna i łatwa obsługa.



Rotation 360°

Mixing water flow with intake air reduces consumption by half, without splashing.

Zmieszany strumień wody z zasysanym powietrzem oszczędza zużycie o połowę i nie chlapie.



ECOflow

Additional protection against contamination.

Dodatkowa ochrona przed zanieczyszczeniami.



built-in-filter

Simple and effective installation thanks to the nut.

Łatwy i trwały montaż dzięki nakrętce.



SMARTnut

PL Przepływowy podgrzewacz wody z baterią
 GB Instant heating faucet
 D Elektrische Warmwasser-Armatur
 RUS Миттевий водонагривач
 CZ Ohřivač vody
 RO Robinet electric
 H Átfolyós vízmelegítő csaptelep
 E Calefacción instantáneo grifo

220-240V-50/60Hz
3-3.6 kW
G 1/2
 0.04-0.6 MPa
 20 cm
1.2 m



FALA

No.	series / seria	
75930	STROKKUR 1	10

PL Przepływowy podgrzewacz wody z baterią
 GB Instant heating faucet
 D Elektrische Warmwasser-Armatur
 RUS Миттевий водонагривач
 CZ Ohřivač vody
 RO Robinet electric
 H Átfolyós vízmelegítő csaptelep
 E Calefacción instantáneo grifo

220-240V-50/60Hz
3-3.6 kW
G 1/2
 0.04-0.6 MPa
 10 cm
1.2 m



FALA

No.	series / seria	
75931	STROKKUR 2	10

PL Przepływowy podgrzewacz wody z baterią
 GB Instant heating faucet
 D Elektrische Warmwasser-Armatur
 RUS Миттевий водонагривач
 CZ Ohřivač vody
 RO Robinet electric
 H Átfolyós vízmelegítő csaptelep
 E Calefacción instantáneo grifo

220-240V-50/60Hz
3-3.6 kW
G 1/2
 0.04-0.6 MPa
 20 cm
1.2 m



FALA

No.	series / seria	
75932	STROKKUR 3	10

PL Przepływowy podgrzewacz wody z baterią
 GB Instant heating faucet
 D Elektrische Warmwasser-Armatur
 RUS Миттевий водонагрівач
 CZ Ohřívač vody
 RO Robinet electric
 H Átfolyós vízmelegítő csaptelep
 E Calefacción instantáneo grifo

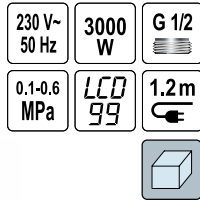

FALA

No.	series / seria	box
75921	KATLA 1	10

PL Przepływowy podgrzewacz wody z baterią
 GB Instant heating faucet
 D Elektrische Warmwasser-Armatur
 RUS Миттевий водонагрівач
 CZ Ohřívač vody
 RO Robinet electric
 H Átfolyós vízmelegítő csaptelep
 E Calefacción instantáneo grifo

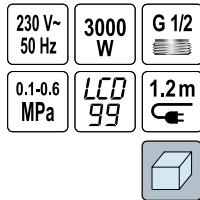

FALA

No.	series / seria	box
75923	KATLA 3	10

PL Pistolet do udrażniania rur
 GB Drain cleaner
 D Pistole zum Reinigen von Rohren
 RUS Пистолет для прочистки труб

CZ Pistole na čistění trubek
 RO Pistol pt. curățarea țevilor
 H Csőtisztító pisztoly
 E Pistola desatapaços

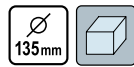

VOREL

No.	Ø (mm)	box
55500	135	10

PL Przepływowy podgrzewacz wody z baterią
 GB Instant heating faucet
 D Elektrische Warmwasser-Armatur
 RUS Миттевий водонагрівач
 CZ Ohřívač vody
 RO Robinet electric
 H Átfolyós vízmelegítő csaptelep
 E Calefacción instantáneo grifo

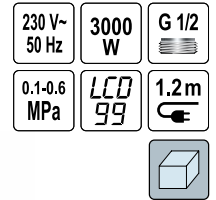

FALA

No.	series / seria	box
75922	KATLA 2	10

PL Przepływowy podgrzewacz wody z baterią
 GB Instant heating faucet
 D Elektrische Warmwasser-Armatur
 RUS Миттевий водонагрівач
 CZ Ohřívač vody
 RO Robinet electric
 H Átfolyós vízmelegítő csaptelep
 E Calefacción instantáneo grifo

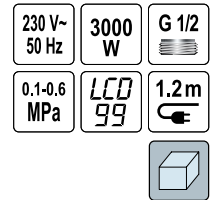

FALA

No.	series / seria	box
75924	KATLA 4	10

PL Pompa do udrażniania kanalizacji
 GB Drain suction pump
 D Hochdruck-Rohreiniger
 RUS Ручной насос для прочистки труб

CZ Čerpadlo na čistění trubek
 RO Pompă pt. curățarea țevilor
 H Csőtisztító szivattyú
 E El desagué del fregadero limpiador



VOREL

No.	Ø (mm)	box
55505	65; 155	24

PL Przepychacz do udrażniania kanalizacji
 GB Pipe cleaner
 D Räumdn zum Reinigen der Kanalisation
 RUS Поршень для прочистки канализации

CZ Tlakový čistíč kanalizace
 RO Piston pt. deblocarea canalizării
 H Lefolyóztító pumpa
 E Bomba desatapaçafos

2
PCS

65
cm



No.	L (cm)	pcs	
55531	65	2	36

PL Spirala kanalizacyjna
 GB Drain auger
 D Hand-Rohrreinigungsspirale
 RUS Трос сантехнический пружинный

CZ Spirála kanalizační
 RO Dispozitiv de defundat scurgere
 H Csőtisztító spirál
 E Desatascador espiral



No.	Ø (mm)	L (m)	
55544	9	5	5/10
55545	9	10	4/8

PL Spirala kanalizacyjna
 GB Drain auger
 D Hand-Rohrreinigungsspirale
 RUS Трос сантехнический пружинный

CZ Spirála kanalizační
 RO Dispozitiv de defundat scurgere
 H Csőtisztító spirál
 E Desatascador espiral

GALVANIZED
STEEL
STÁL
OCTYNKOWANA



No.	Ø (mm)	L (m)	
55541	5	1.5	20/80
55542	6	3	18/36

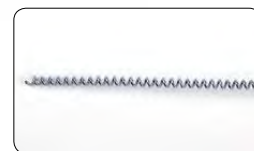

GALVANIZED
STEEL
STÁL
OCTYNKOWANA



Memo

Memo

No.	Page	No.	Page	No.	Page	No.	Page	No.	Page	No.	Page	No.	Page	No.	Page
00250	152	04630	153	05921	165	06410	158	06990	105	08177	94	08630	94	08851	94
00300	148	04640	153	05922	165	06420	159	06992	106	08186	95	08631	94	08853	94
00320	148	04650	153	05923	165	06430	159	06993	106	08188	95	08633	94	08854	94
00510	148	04660	153	05924	165	06440	158	06994	106	08190	95	08635	94	08855	94
00600	148	04668	153	05925	165	06450	168	06995	106	08191	95	08636	94	08860	96
00610	148	04670	153	05926	165	06452	168	07060	116	08193	95	08638	94	08861	96
01060	148	04690	152	05950	163	06453	169	07080	116	08200	95	08639	94	08864	96
02300	148	04691	152	05960	164	06470	159	07100	116	08201	95	08640	94	08865	96
02400	148	04692	153	05971	164	06472	159	07120	116	08271	118	08641	94	08868	96
03150	149	04693	153	05972	164	06500	159	07180	116	08272	118	08642	94	08869	96
03160	149	04699	152	05973	164	06510	159	07240	116	08273	118	08644	94	08873	96
03220	149	04700	153	05980	164	06512	160	07320	116	08274	118	08646	94	08875	96
03221	149	04710	153	06030	163	06520	159	07400	116	08275	118	08663	94	08876	96
03240	88	04720	154	06040	163	06530	159	07506	116	08276	118	08665	94	09005	167
03241	88	04721	154	06050	163	06532	160	07508	116	08277	118	08669	94	09006	167
03245	88	04750	162	06060	163	06537	160	07510	116	08288	117	08671	95	09010	167
03246	88	04755	162	06080	163	06538	160	07512	116	08289	117	08672	95	09015	167
03300	89	05050	111	06100	163	06540	159	07530	117	08290	117	08674	95	09017	167
03301	89	05100	111	06110	161	06640	160	07540	117	08291	117	08683	95	09025	167
03900	150	05300	176	06120	161	06650	160	07560	117	08292	117	08710	92	09028	168
03920	151	05301	176	06130	163	06660	160	07580	117	08293	117	08711	92	09036	168
03940	151	05302	176	06150	163	06670	160	07610	117	08300	106	08712	92	09038	168
03950	151	05311	176	06290	163	06680	160	07620	117	08301	117	08714	92	09040	168
03990	88	05312	176	06294	164	06690	160	07630	117	08302	117	08715	92	09044	167
04000	149	05540	89	06295	164	06700	160	07650	116	08303	117	08731	93	09046	167
04001	149	05560	89	06296	164	06701	160	07664	117	08304	117	08732	93	09048	168
04020	149	05580	89	06297	164	06740	160	07665	117	08306	117	08734	93	09049	168
04022	149	05600	89	06298	164	06760	160	07666	117	08307	117	08735	93	09050	168
04050	151	05750	166	06299	164	06780	160	07667	117	08308	117	08751	93	09051	168
04100	151	05751	166	06300	164	06781	160	07668	117	08312	106	08752	93	09054	168
04200	149	05752	166	06301	164	06790	166	07879	117	08314	106	08754	93	09056	168
04210	149	05760	166	06302	164	06795	165	07880	117	08315	106	08755	93	09060	167
04300	50: 132	05761	166	06303	164	06796	166	07881	117	08316	106	08770	96	09063	167
04301	50: 132	05770	166	06304	164	06797	165	07882	117	08318	107	08771	96	09065	167
04400	150	05771	166	06305	164	06799	166	07883	117	08350	107	08780	92	09080	167
04405	150	05772	166	06306	164	06820	111	07884	117	08400	107	08781	92	09090	167
04406	150	05773	166	06307	164	06840	111	07885	117	08410	107	08782	92	09094	168
04410	150	05774	166	06308	164	06860	111	07886	117	08500	107	08783	92	09096	168
04440	150	05801	161	06309	164	06930	104	07910	117	08501	107	08785	93	09097	168
04450	137	05802	161	06310	165	06940	104	07911	117	08510	107	08786	93	09100	136
04451	137	05803	161	06320	165	06950	104	07912	117	08511	107	08787	93	09120	137
04452	137	05804	161	06330	165	06960	104	07913	117	08520	107	08788	93	09130	136
04490	151	05805	161	06331	165	06963	104	07914	117	08521	107	08790	93	09150	136
04500	151	05806	161	06335	166	06964	104	07915	117	08522	107	08791	93	09160	137
04510	151	05807	161	06340	161	06965	104	07916	117	08534	118	08792	93	09170	137
04540	152	05821	162	06341	161	06970	104	07930	115	08536	118	08793	93	09171	137
04542	152	05822	162	06350	161	06971	104	07950	118	08538	118	08811	93	09172	137
04544	152	05823	162	06351	161	06972	104	07960	118	08540	118	08819	93	09173	138
04546	152	05830	162	06360	161	06973	104	07962	119	08542	118	08820	93	09174	138
04561	338	05831	162	06370	161	06974	105	07970	118	08545	118	08821	93	09180	177
04562	338	05840	162	06380	161	06975	105	07974	95	08553	118	08822	94	09190	177
04581	153	05850	162	06388	175: 439	06976	105	07975	95	08554	118	08825	94	09302	169
04582	153	05901	165	06390	175: 439	06977	105	07976	95	08556	118	08827	94	09303	169
04583	153	05902	165	06391	175	06978	105	07977	95	08558	118	08828	94	09307	169
04584	153	05903	165	06392	175: 439	06979	105	07978	95	08560	118	08829	94	09308	169
04585	153	05904	165	06393	175: 439	06980	105	07984	95	08562	118	08831	94	09310	170
04586	153	05905	165	06394	176	06981	105	07985	95	08565	118	08832	94	09311	170
04591	153	05906	165	06395	176	06982	105	07986	95	08573	118	08833	94	09331	170
04592	153	05911	165	06396	176	06983	105	07987	95	08574	118	08834	94	09332	170
04593	153	05912	165	06397	175	06985	105	07988	95	08576	118	08835	94	09334	169
04594	153	05913	165	06398	175	06986	105	08170	94	08578	118	08836	94	09336	169
04600	153	05914	165	06399	175	06987	105	08171	94	08580	118	08837	94	09338	170
04610	153	05915	165	06400	158	06988	105	08174	94	08582	118	08838	94	09345	169
04620	153	05916	165	06401	158	06989	105	08175	94	08585	118	08845	94	09346	169

No.	Page	No.	Page	No.	Page	No.	Page	No.	Page	No.	Page	No.	Page	No.	Page
09359	169	09583	172	15100	185	17730	157; 441	21700	89	23311	84	23592	87	24310	90
09363	170	09585	172	15110	185	17733	157; 441	21701	89	23312	84	23593	87	24320	90
09365	170	09587	172	15115	185	18000	190	21702	89	23313	84	23594	87	24330	90
09370	169	09589	172	15120	185	18001	191	21703	89	23314	84	23601	86	24340	90
09371	169	09636	172	15130	184	18200	188	21704	89	23315	84	23602	86	24350	90
09372	169	09638	172	15200	184	18201	188	21705	89	23316	84	23603	86	24370	90
09373	169	09640	172	15220	185	18250	188	21706	89	23317	84	23604	86	24390	90
09375	170	09642	172	15240	185	18300	188	21709	90	23318	84	23605	87	24410	90
09377	170	09647	172	15291	193	18350	188	21900	82	23319	84	23606	87	24430	90
09378	170	09648	172	15292	193	18360	188	21905	82	23320	84	23608	87	24450	90
09385	170	09649	172	15301	193	18361	188	21910	82	23321	84	23620	85	24470	90
09390	171	09650	172	16000	193	18362	188	21915	82	23324	84	23640	85	24500	90
09395	171	09651	172	16001	193	18470	189	21919	82	23325	84	23650	85	24510	90
09400	175	09653	172	16002	193	18473	189	21921	82	23326	84	23660	85	24520	90
09406	170	09655	172	16012	192	18501	188	21924	82	23327	84	23670	85	24530	90
09408	170	09656	172	16030	150	18502	188	21927	82	23328	84	23680	85	24550	90
09413	170	09900	161	16280	191	18503	188	21929	82	23329	84	23690	85	24570	90
09421	171	09903	161	16300	191	18504	188	21932	82	23331	84	23692	85	24590	90
09422	171	09920	172	16301	192	18530	189	21934	82	23371	86	23693	85	24610	90
09425	171	09930	172	16340	192	18790	189	21936	82	23372	86	23694	85	24630	90
09427	171	09950	172	16360	192	18797	189	21941	82	23373	86	23710	85	24650	90
09429	171	10010	339	16380	192	18798	189	21944	82	23374	86	23720	85	24670	90
09430	171	10011	340	16400	192	18799	189	21948	82	23375	86	23722	85	24700	91
09457	173	10012	340	16551	192	18800	189	21950	82	23376	86	23723	85	24710	91
09459	173	10013	340	16552	192	18810	189	21951	82	23377	86	23724	85	24730	91
09462	173	10014	340	16553	192	19750	190	21952	82	23378	86	23730	85	24740	91
09463	173	10015	340	16554	192	19755	190	21955	82	23379	86	23740	85	24750	91
09465	338	10101	183	16555	192	19770	190	21956	82	23380	86	23750	85	24800	91
09466	338	10104	183	16556	192	20100	81	21958	82	23381	86	23752	85	24810	91
09467	338	10106	183	16557	192	20150	81	21961	82	23382	86	23800	85	24813	91
09470	173; 338	10109	183	17300	188	20200	81	21963	82	23383	86	23820	85	24820	91
09471	173; 338	10111	183	17310	188	20250	81	21966	82	23390	86	23830	85	24823	91
09472	173; 338	10122	183	17430	187	20280	81	21998	82	23391	86	23832	85	24900	91
09473	339	10123	183	17470	144; 186	20300	81	21999	82	23392	86	23840	85	24940	90
09474	339	10125	183	17471	144; 186	20320	81	22130	81	23393	86	23850	85	24950	91
09475	173; 338	10128	183	17473	144; 186	20350	81	22180	81	23394	86	23860	85	24960	90
09476	173; 338	10129	183	17474	144; 186	20400	81	22190	81	23395	86	23862	85	24961	90
09477	173; 338	10130	183	17480	144; 186	20420	81	22250	81	23396	86	23880	85	24962	90
09478	173; 338	10133	183	17481	144; 186	20450	81	22300	81	23397	86	23882	85	24963	90
09480	339; 439	10135	183	17483	144; 186	20500	81	22310	81	23398	86	23883	85	24964	90
09481	338; 439	10138	183	17484	144; 186	20550	81	22330	81	23399	86	23920	85	24965	90
09482	339; 439	10139	183	17488	143; 186	20600	81	22340	81	23400	86	23930	85	24966	90
09483	339; 439	11310	183	17489	143; 186	20650	81	22350	84	23401	86	23932	85	25160	113
09484	339; 439	11311	183	17490	143; 186	20700	81	22380	84	23402	86	23960	85	25161	113
09486	339	11313	183	17495	143; 186	20800	81	22381	84	23403	86	23962	85	25162	113
09487	339	12100	184	17497	143; 186	20850	81	22430	85	23411	86	23980	85	25163	113
09489	339	12200	184	17498	143; 186	20900	81	22431	85	23412	86	23982	85	25164	113
09490	339	12300	184	17500	185	21000	81	22460	84	23413	86	23988	86	25165	113
09521	171	12500	184	17501	185	21100	81	22465	85	23414	86	23990	85	25166	113
09522	171	13200	184	17505	185	21200	81	22466	85	23415	86	23992	85	25170	114
09523	171	13300	184	17507	186	21250	81	22500	85	23416	86	23999	85	25171	115
09524	171	13500	184	17508	186	21300	81	22550	92	23417	86	24000	92	25172	115
09525	171	14100	184	17560	192	21400	81	22551	92	23418	86	24100	135	25173	115
09531	171	14200	184	17570	189	21600	81	22565	88	23419	86	24110	135	25230	115
09532	171	14300	184	17606	192	21650	82	22570	88	23420	86	24111	135	25300	115
09533	171	14500	184	17608	192	21680	83	22571	88	23421	86	24112	135	25301	115
09534	171	15004	184	17610	192	21682	83	22572	88	23422	86	24113	134	25307	115
09535	171	15005	184	17612	192	21684	83	22610	82	23423	86	24120	135	25310	116
09536	171	15006	184	17615	192	21686	83	22611	82	23424	86	24121	135	25351	114
09537	171	15007	184	17620	192	21688	83	22612	83	23460	88	24122	136	25352	114
09560	171	15010	184	17701	156; 440	21690	83	22613	83	23585	87	24130	136	25353	114
09561	171	15020	184	17702	157; 440	21691	83	22616	83	23586	87	24140	136	25360	114
09562	171	15050	184	17704	157; 441	21692	83	22617	83	23590	86	24295	91	25370	114
09581	172	15070	184	17705	158; 441	21695	83	22640	83	23591	86	24300	90	25380	114

No.	Page	No.	Page	No.	Page	No.	Page	No.	Page	No.	Page	No.	Page	No.	Page
25390	114	27832	104	30060	64	32923	71; 411	34247	68	35755	420	35840	417	37112	74
25400	272	27833	104	30080	64	32924	70; 410	34251	68	35756	415	35842	418	37113	74
25405	92; 273	27834	104	30100	64	32925	70; 410	34254	68	35757	415	35843	414	37114	74
25410	272	27850	102	30150	64	32926	70; 410	34256	68	35758	415	35846	417	37115	74
25411	272	28000	99; 162	30200	64	32927	70; 410	34300	69	35759	415	35850	417	37150	74
25412	272	28010	99; 162	30310	64	32928	70; 410	34600	69	35760	421	35855	415	37200	74
25420	119	28011	99; 163	30320	64	32930	69; 409	34750	69	35761	415	35860	418	37250	74
25450	272	28012	99; 163	30330	64	32999	70; 410	34900	69	35762	415	35861	415	37300	74
25500	67	28380	98	30340	64	33000	70; 410	34944	167	35763	418	35863	415	37380	74
25510	67	28381	98	30350	64	33001	70; 410	34945	167	35764	419	35864	418	37400	74
25511	67	28382	98	30360	64	33002	70; 410	34946	167	35765	412	35865	418	37430	74
25512	67	28385	98	30380	64	33003	70; 410	34947	167	35767	412	35867	336	37500	74
25513	67	28386	98	30390	64	33004	70; 410	34949	441	35768	412	35868	336	37800	74
25514	67	28387	98	30395	64	33005	70; 410	34950	177	35770	419	35869	336	37900	74
25515	67	28394	99	30400	64	33006	70; 410	35010	178	35773	419	35870	336	38150	74
25516	67	28395	99	30410	64	33007	70; 410	35012	178	35774	419	35872	336	38200	74
25517	67	28640	408	30420	64	33008	70; 410	35013	178	35775	421	35874	336	38401	74
25518	67	28641	408	30430	64	33022	71; 410	35015	178	35776	419	35875	336	38402	74
25519	67	28642	408	30440	64	33024	70; 410	35017	178	35777	420	35876	336	38403	74
25520	67	28650	99	30450	64	33026	70; 410	35020	178	35779	419	35877	336	38404	74
25521	67	28680	89	30460	64	33028	70; 410	35021	179	35780	419	35893	337; 422	38406	74
25530	67	28690	89	30480	64	33030	70; 410	35025	179	35781	418	35894	337; 422	38407	74
25700	67	28710	89	30500	64	33032	70; 410	35026	179	35782	418	35895	337; 422	38408	74
25830	112	28720	89	30510	64	33035	70; 410	35030	179	35783	418	35899	337; 422	38409	74
25860	113	28725	89	30520	64	33038	70; 410	35031	179	35784	418	35905	337; 422	38430	76
26130	114	28733	89	30531	64	33039	70; 410	35032	179	35785	419	35906	337; 422	38431	76
26131	114	28740	99; 408	30532	64	33040	70; 410	35033	179	35786	420	35908	337; 422	38432	76
26132	114	28745	99; 408	30533	64	33065	70; 409	35210	111	35787	420	35911	336; 422	38433	76
26140	114	28746	99; 409	30534	64	33067	69; 409	35240	111	35788	420	35912	337; 422	38434	76
26150	116	28750	99; 408	30535	64	33080	69; 409	35250	68	35789	420	35914	336	38435	76
26200	116	28755	99; 409	30536	64	33085	70; 409	35300	68	35790	420	35915	336	38436	76
26210	116	28771	99; 409	31010	64	33087	69; 409	35351	68	35791	420	35916	336	38500	75
26220	116	28772	99; 409	31030	64	33105	70; 409	35352	68	35792	419	35918	336	38515	75
26225	116; 271	28773	99; 409	31050	64	33107	69; 409	35353	68	35793	421	35923	336	38525	75
27000	100	28790	101	31070	64	33125	70; 409	35355	68	35794	421	35924	336	38531	75
27100	100	28880	148	31100	64	33127	69; 409	35359	68	35795	421	35950	337; 422	38620	75
27200	100	29000	101	31150	64	33147	69; 409	35360	68	35797	416	36000	76	38641	75
27322	100	29050	101	31200	64	33177	69; 409	35362	68	35798	419	36004	76	38642	75
27495	100	29090	103	31300	64	33530	67	35364	68	35799	416	36005	76	38643	75
27500	102	29100	103	31400	64	33532	67; 282	35366	68	35800	416	36006	76	38750	75
27501	102	29210	101	31500	64	33535	66	35368	68	35801	416	36008	76	38751	75
27502	102	29220	101	31600	64	33550	66	35372	68	35802	416	36014	76	38830	76
27505	102	29311	101	31800	64	33555	66	35373	68	35803	416	36015	76	40010	48
27506	102	29312	101	32000	64	33557	66	35374	68	35805	417	36016	76	40011	48
27510	102	29313	101	32110	65; 282	33650	66	35376	68	35806	417	36018	76	40012	48
27511	102	29317	101	32201	65	33655	66	35430	68	35807	417	36032	77	40013	48
27513	102	29318	101	32202	65	33657	66	35600	176; 439	35808	417	36033	77	40014	48
27520	103	29319	101	32203	65	33900	66	35608	438	35809	414	36034	77	40015	48
27530	102	29323	101	32204	65	33905	66	35610	439	35810	414	36037	77	40016	48
27533	102	29400	158	32205	65	33907	66	35611	439	35811	414	36038	77	40017	48
27540	150	29401	158	32206	65	33925	66	35620	442	35813	418	36039	77	40018	48
27575	93	29404	158	32207	65	33950	67; 282	35621	442	35815	418	36570	77; 122	40041	48
27600	100	29410	158	32208	65	34204	69	35622	442	35816	418	36650	76	40042	48
27610	100	29992	65	32625	65	34205	69	35670	416	35817	415	37100	74	40043	48
27800	103	29993	65	32627	66	34206	69	35671	416	35821	423	37101	74	40044	48
27810	103	29994	65	32685	65	34207	69	35680	416	35823	423	37102	74	40045	48
27811	103	29995	65	32687	66	34208	69	35700	420	35824	423	37103	74	40047	48
27812	103	29996	65	32705	66	34210	69	35701	415	35826	423	37104	74	40048	48
27813	103	29997	65	32715	66	34212	69	35705	415	35828	423	37106	74	40050	48
27814	103	30010	64	32720	65	34220	69	35710	421	35830	423	37107	74	40051	48
27815	103	30020	64	32900	71	34222	69	35740	418	35831	423	37108	74	40054	49
27820	103	30030	64	32901	71	34225	69	35741	418	35832	423	37109	74	40055	49
27830	104	30040	64	32902	71	34243	68	35750	420	35833	414	37110	74	40056	49
27831	104	30050	64	32922	71; 411	34245	68	35751	420	35839	417	37111	74	40057	49

No.	Page	No.	Page	No.	Page	No.	Page	No.	Page	No.	Page	No.	Page	No.	Page
40160	50	48000	96: 283	51040	8	51710	9	53338	16	54670	12	56478	44	58661	20
40180	50	48050	97: 283	51042	8	51715	10	53339	16	54680	12	56505	44; 305	58685	21
40200	50	48060	96: 283	51044	8	51720	9	53340	16	54690	12	56506	44; 305	58687	21
40700	50	48070	97: 284	51046	8	51721	9	53341	16	54700	12	56507	44; 305	58688	22
41121	49	48080	96: 283	51047	8	51722	9	53400	16	54710	12	56550	44	58689	20
41151	49	48081	97: 284	51048	8	51740	11	53410	16	54720	12	56600	44	58690	21
41152	49	48082	97: 283	51049	8	51741	11	53420	16	54730	12	56710	11	58691	22
41180	49	48100	97: 283	51051	8	52100	11	53430	16	54750	12	56720	11	58692	21
41200	49	48150	97: 284	51060	8	52120	11	53440	16	54760	12	56730	11	58693	23
41381	50	48200	97: 283	51070	8	52130	11	53450	16	54780	12	56740	11	58700	22
41500	49	48330	97: 284	51080	8	52170	11	53460	16	55100	54; 123	56770	11	58705	20
41510	54; 122	48350	98	51090	8	52190	11	53470	16	55150	54; 123	56780	11	60750	28
42300	50	49200	98	51100	8	52220	11	53480	16	55200	54; 123	56790	11	60780	27
42301	50	49450	98	51110	8	52270	11	53490	16	55210	54; 123	57000	219	60781	27
42302	51	49460	98	51120	8	52340	11	53500	17	55211	54; 123	57010	220	60782	27
42303	50	49600	98	51130	8	52560	11	53520	17	55212	54; 123	57020	220	60783	27
42304	51	49750	98	51140	8	52570	11	53540	17	55215	54; 123	57030	220	60785	27
42305	51	49760	98	51150	8	52580	11	53560	17	55216	54; 123	57050	220	60880	26
42306	51	49770	98	51160	8	52630	11	53561	17	55217	54; 123	57091	222; 252	60881	26
42307	51	49771	98	51170	8	52652	10	53562	17	55220	54; 123	57092	222; 252	60882	26
42308	51	49772	98	51180	8	52653	10	53563	17	55221	54; 123	57097	222; 252	60883	26
42309	51	49773	98	51190	8	52654	10	53571	17	55222	54; 123	57100	220	60884	26
43010	51	49774	98	51200	8	52655	10	53572	17	55250	54; 122	57160	220	60885	26
43011	51	49775	98	51210	8	52656	10	53573	17	55300	54; 122	57210	220	60886	26
43020	52	49780	177	51220	8	52657	10	53575	17	55350	54; 122	57220	221	60887	26
43021	52	49781	177	51240	8	52658	10	53576	17	55500	127; 344; 495	57221	221	60888	26
43030	52	49782	177	51270	8	52659	10	53577	17	55505	127; 344; 495	57260	220	60889	26
43031	52	49785	177	51300	8	52660	10	53580	18	55531	127; 345; 496	57300	13	60890	26
43040	52	49786	177	51320	8	52661	10	53598	17	55541	127; 345; 496	57350	13	60891	26
43041	52	49787	177	51560	8	52680	11	53599	17	55542	127; 345; 496	57400	13	60910	30
43050	52	49790	177	51580	8	52700	11	53600	17	55544	127; 345; 496	57450	13	60912	26
43051	52	49791	177	51590	8	52710	11	53610	16	55545	127; 345; 496	57451	13	60913	26
43052	52	49792	177	51620	8	52720	11	53630	16	55620	54; 123	57600	217	60914	26
43053	52	49800	178	51630	8	52730	11	53650	16	55625	54; 123	57610	218	60915	26
43055	52	49801	178	51640	8	52740	11	53670	16	55630	54; 123	57612	218	60916	26
43056	52	49802	178	51645	8	52750	11	53700	17	55635	54; 123	57613	218	60917	26
43057	52	49805	178	51650	8	52770	11	53710	17	55645	54; 123	57614	218	60918	26
43058	52	49806	178	51671	9	52790	11	53730	17	55660	54; 123	57620	218	60920	26
43060	52	49810	177	51672	9	52820	11	54000	12	55690	54; 123	57630	218	60921	26
43061	52	49830	177	51673	9	52900	12	54061	12	55740	124	57640	218	60922	26
43062	52	49840	133	51674	9	52935	12	54062	12	55792	55; 123	57649	218	60923	26
43063	52	49841	133	51675	9	52936	12	54063	12	55800	122	57650	218	60924	26
43140	52	50070	10	51676	9	53002	16	54065	13	55820	122	57651	218	60931	26
43500	53	50090	10	51677	9	53003	16	54066	13	55830	122	57700	221	60932	26
43510	53	50100	10	51678	9	53080	16	54067	13	56040	43	57830	213	60933	26
43600	112	50110	10	51679	9	53100	16	54068	13	56050	43	58140	19	60934	26
43603	112	50120	10	51680	9	53120	16	54070	13	56060	43	58150	19	60935	26
44100	53	50130	10	51681	9	53130	16	54071	13	56070	43	58160	18	60936	26
44102	53	50150	10	51682	9	53140	16	54072	13	56080	43	58210	18	60937	26
44300	53; 282	50170	10	51683	9	53150	16	54073	13	56100	43	58240	18	60938	26
44301	53; 282	50190	10	51684	9	53160	16	54080	13	56120	43	58260	18	60939	26
44400	53; 282	50220	10	51685	9	53170	16	54081	13	56130	43	58520	18	60950	26
44500	53; 283	50270	10	51686	9	53180	16	54497	55; 123	56140	43	58539	213	60951	26
45000	58	50330	10	51687	9	53190	16	54498	55; 123	56170	43	58540	210	60952	26
45010	58	50560	10	51688	9	53210	16	54499	55; 123	56380	43	58550	212	60953	26
45012	58	50580	10	51689	9	53220	16	54500	55; 123	56390	43	58560	211	60954	26
45020	59	50590	10	51690	9	53240	16	54510	55; 123	56391	43	58561	213	60955	26
45050	58	50610	10	51691	9	53270	16	54600	12	56392	43	58600	19	60956	26
45100	59	50620	10	51692	9	53300	16	54610	12	56393	43	58602	19	60957	26
45151	59	50630	10	51693	9	53320	16	54620	12	56400	43	58633	19	60958	26
45160	59	50850	8	51694	9	53332	16	54630	12	56470	43	58634	19	60959	26
45201	59	50861	8	51695	9	53335	16	54640	12	56473	43	58640	19	60961	26
45500	58	50871	8	51696	9	53336	16	54650	12	56475	44	58641	20	60962	26
45503	58	50880	9	51705	9	53337	16	54660	12	56477	44	58643	20	60963	26

No.	Page	No.	Page	No.	Page	No.	Page	No.	Page	No.	Page	No.	Page	No.	Page
60964	26	62163	28	65451	38	67092	324	67950	308	69334	484	69572	144; 187	71823	477
60965	26	62164	28	65452	38	67110	324	67961	308	69337	484	69608	145; 188	71824	477
60966	26	62165	28	65453	38	67111	324	68011	321	69338	484	69609	145; 188	71825	477
60967	26	62166	28	65454	38	67115	325	68050	316	69339	484	69610	145; 188	71827	478
60968	26	62167	28	65456	39	67116	325	68051	316	69340	485	69612	145; 188	71828	478
60969	26	62170	28	65457	39	67120	324	68052	317	69341	485	69613	145; 188	71829	478
60970	26	62171	28	65458	39	67160	335	68053	317	69344	485	69620	144; 187	71830	478
60975	28	62172	28	65461	38	67161	335	68100	326	69345	485	69621	144; 187	71831	478
60990	27	62173	28	65462	39	67162	335	68115	326	69346	485	69630	144; 187	71832	478
61010	28	62174	28	65470	38	67163	336	68172	313	69347	485	69631	144; 187	71833	478
61020	28	62175	28	65471	38	67164	335	68173	313	69348	485	69635	145; 187	71834	478
61030	28	62176	28	65472	38	67165	335	68174	313	69350	485	69637	145; 187	71835	478
61040	28	62177	28	65475	39	67166	336	68193	314	69351	486	69851	442	71836	478
61050	28	62178	28	65476	39	67170	337	68194	314	69352	486	70000	130	71837	478
61060	28	64050	35	65477	39	67171	338	68195	314	69353	486	70020	130	71838	478
61070	28	64060	35	65480	38	67200	325	68250	322	69354	486	70023	130	71840	478
61080	28	64070	35	65481	38	67201	325	68251	323	69357	486	70030	130	71841	478
61090	28	64090	36	65482	38	67220	325	68260	323	69358	486	70035	130	71842	478
61100	29	64310	37	65483	38	67221	326	68270	318	69359	486	70100	130	71843	478
61110	29	64330	37	65490	38	67230	327	68271	318	69360	486	70160	131	71844	478
61120	29	64370	36	65491	38	67231	326	68272	318	69361	487	70201	131	71846	478
61130	29	64371	36	65492	38	67260	172; 338; 435	68273	318	69362	487	70202	131	71847	478
61140	29	64384	37	65493	38	67420	321	68480	314	69363	487	70210	131	71848	478
61150	29	64385	34	65494	38	67451	320	68481	315	69370	487	70270	131	71849	478
61160	29	64386	33	65495	38	67453	321	68621	480	69371	487	70280	132; 207	71850	478
61170	29	64395	37	65496	38	67455	321	68622	481	69372	487	70320	131	71851	478
61210	29	64396	37	65497	38	67456	320	68623	481	69373	487	70330	131	71852	478
61220	29	64400	36	65498	38	67457	320	68800	490	69374	487	70340	131	71853	478
61230	29	64401	36	65501	38	67470	322	68801	491	69375	488	70400	131	71854	478
61240	29	64402	32	65502	38	67500	319	68820	491	69376	488	70410	131	71855	478
61250	29	64553	38	65503	38	67501	319	68830	491	69377	488	70420	131	71856	478
61260	29	64554	38	65504	38	67520	320	68831	491	69378	488	70430	131	71857	478
61270	29	64555	37; 219	65505	38	67570	315	68832	491	69390	468	70480	131	71858	478
61280	29	64650	35	65520	39	67571	315	68833	491	69391	468	70490	131	71859	478
61290	29	64654	31	65610	39	67572	315	69201	492	69395	468	70500	131	71860	478
61300	29	64655	33	65620	39	67573	316	69202	492	69396	468	70510	131	71860	478
61310	29	64658	32	65630	39	67574	316	69203	492	69397	468	71000	132	71860	478
61320	29	64660	33	65640	39	67640	317	69204	492	69400	488	71040	132	71970	134
61330	29	64950	31	65650	39	67641	317	69205	493	69401	488	71050	132	71971	134
61340	29	64951	31	65700	39	67660	319	69206	493	69402	488	71052	132	71972	134
61350	29	64952	31	65705	40	67661	319	69300	481	69403	488	71053	132	71973	134
61360	29	64960	31	65800	40	67700	310	69301	481	69404	489	71060	133	71974	134
61375	30	65015	32	65840	42	67701	310	69302	481	69405	489	71080	133	71975	134
61376	30	65020	34	65850	42	67702	310	69303	481	69406	489	71160	133	71976	134
61377	30	65022	33	65880	36	67703	311	69304	482	69407	489	71800	477	71977	134
61378	30	65023	33	66080	42	67704	311	69305	482	69408	489	71801	477	71978	134
61379	30	65025	33	66112	42	67705	311	69306	482	69502	144; 187	71802	477	71979	134
61380	30	65033	34	66113	42	67780	309	69307	482	69503	144; 187	71803	477	71980	134
61381	30	65034	32	66200	42	67781	309	69308	482	69504	144; 187	71804	477	71981	134
61382	30	65035	32	66210	42	67790	310	69311	482	69505	144; 187	71805	477	71982	134
61383	30	65041	31	66301	40	67805	308	69312	482	69506	144; 187	71807	477	71983	134
61384	30	65045	35	66302	40	67810	309	69313	482	69507	144; 187	71808	477	71984	134
61385	30	65046	35	66310	40	67811	309	69314	483	69508	144; 187	71809	477	71985	134
61386	30	65100	35	66330	40	67840	311	69315	483	69509	144; 187	71810	477	71986	134
61392	30	65105	32	66400	41	67841	312	69316	483	69510	144; 187	71811	477	71987	134
61393	30	65120	34	66410	41	67850	312	69317	483	69521	144; 186	71812	477	71988	134
61394	30	65123	34	66570	41	67853	312	69318	483	69539	145; 187	71814	477	71989	134
61395	30	65124	34	66580	41	67860	308	69319	483	69540	145; 187	71815	477	71990	134
61550	30	65150	35	66710	41	67880	322	69320	483	69542	145; 187	71816	477	71991	134
61560	30	65170	31	66720	41	67882	322	69321	483	69543	145; 187	71817	477	71992	134
61600	30	65233	60	66760	41	67887	322	69330	484	69546	145; 187	71818	477	71993	134
62160	28	65235	60	66770	41	67888	322	69331	484	69550	145; 188	71819	477	71994	134
62161	28	65260	221	67090	323	67900	312	69332	484	69551	145; 188	71820	477	71995	134
62162	28	65270	221	67091	323	67901	313	69333	484	69552	145; 188	71821	477	71996	134

No.	Page	No.	Page	No.	Page	No.	Page	No.	Page	No.	Page	No.	Page	No.	Page
72120	133	72821	372	72943	333	73260	140; 273	73590	138	73953	371; 434	74193	369; 436	74646	373
72140	133	72822	372	72944	333	73270	140; 273	73598	139	73954	371; 434	74194	369; 436	74647	373
72400	378	72823	372	72945	333	73271	140; 273	73612	139	73955	371; 434	74195	369; 436	74660	372
72401	378	72824	372	72948	332	73300	140; 273	73614	139	73958	371; 435	74400	279; 365	74661	372
72402	378	72825	372	72950	332	73325	155	73616	139	73959	371; 435	74410	279; 365	74662	372
72404	377	72826	372	72951	332	73330	155	73620	139	73960	371; 435	74411	280; 365	74663	372
72407	377	72827	372	72952	332	73331	155	73621	139	73961	371; 435	74420	279	74664	373
72451	377	72828	372	72953	332	73340	155	73625	139	73962	371; 435	74421	279	74665	373
72452	377	72829	372	72954	332	73341	156	73627	139	73963	371; 435	74422	279	74666	373
72455	377	72831	370; 433	72955	332	73342	156	73632	139	73964	371; 435	74430	279	74667	373
72484	376	72832	370; 433	72956	333	73343	156	73640	139	73966	371; 435	74431	279	74680	355
72486	376	72833	370; 433	72958	333	73350	156	73645	139	73967	371; 435	74432	279	74681	355
72489	376	72834	370; 433	72960	333	73351	156	73660	139	73968	371; 435	74439	282; 368	74685	355
72490	376	72835	370; 433	72963	334	73352	156	73670	139	73969	371; 435	74440	280; 365	74688	356
72493	376	72836	370; 433	72964	334	73353	156	73680	139	73970	371; 435	74441	280; 366	74689	356
72494	376	72840	370; 433	72965	334	73360	156	73695	139	73971	371; 435	74442	280; 365	74721	346
72500	376	72841	370; 433	72966	334	73362	156	73700	139	73972	371; 435	74443	280; 366	74722	346
72501	376	72842	370; 433	72967	334	73400	125; 154	73710	139	73973	371; 435	74447	280; 366	74723	346
72504	376	72843	370; 433	72968	334	73403	126; 154	73720	139	74060	363	74448	280; 366	74724	346
72505	376	72844	370; 433	72969	334	73404	126; 154	73730	139	74077	362	74449	281; 366	74730	352
72506	376	72845	370; 433	72970	334	73410	125; 154	73740	139	74078	362	74450	280; 366	74731	353
72508	376	72846	370; 433	72972	331	73412	125; 155	73775	139	74079	362	74451	281; 368	74732	353
72509	376	72850	370; 433	72973	331	73413	125; 155	73820	139	74080	362	74452	282; 368	74733	353
72510	376	72851	370; 433	72974	334	73420	125; 154	73831	138	74081	363	74453	282; 368	74734	353
72524	376	72852	370; 433	72975	334	73470	271	73833	138	74082	363	74454	282; 368	74740	353
72525	376	72853	370; 433	72976	334	73473	271	73835	138	74094	360	74455	282; 368	74741	353
72526	376	72854	370; 433	72977	334	73500	273	73875	140	74100	360; 431	74457	281; 366	74744	353
72527	376	72858	370; 434	72978	334	73503	193	73881	139	74102	360	74459	363	74750	353
72528	376	72859	370; 434	72979	334	73506	139; 400	73882	139	74104	360	74460	363	74751	354
72529	376	72860	370; 434	72981	334	73507	139; 400	73883	139	74106	360	74461	367; 436	74752	354
72530	376	72861	370; 434	72984	334	73508	139; 400	73884	139	74108	360	74462	367; 436	74753	354
72531	376	72862	370; 434	72985	335	73510	139; 400	73885	139	74110	360; 432	74463	367	74755	354
72532	376	72863	370; 434	72986	335	73511	139; 400	73886	139	74111	361; 433	74464	367	74765	354
72533	376	72864	370; 434	72994	332	73515	138	73887	139	74113	361; 433	74466	368	74771	354
72534	376	72871	370; 434	72995	332	73516	138	73888	139	74115	361; 433	74468	368	74772	354
72535	376	72872	370; 434	72996	332	73517	138	73889	139	74117	361; 432	74480	281; 367	74772	354
72570	377	72873	370; 434	72997	332	73521	138	73892	139	74121	361; 432	74483	281; 367	74773	354
72572	377	72874	370; 434	72998	332	73522	138	73893	139	74123	361; 432	74484	281; 367	74775	355
72573	377	72875	370; 434	72998	332	73522	138	73894	139	74125	360; 432	74501	364; 437	74776	355
72615	376	72876	370; 434	73004	331	73523	138	73895	139	74126	361; 432	74502	364; 437	74777	355
72616	376	72877	370; 434	73005	331	73525	138	73896	139	74127	361; 432	74503	364; 437	74780	466
72617	376	72878	370; 434	73006	331	73527	138	73897	139	74128	361; 432	74504	364; 437	74781	466
72620	376	72881	370; 433	73021	333	73528	138	73898	139	74130	360; 432	74508	364; 437	74782	466
72621	376	72882	370; 433	73022	333	73529	138	73906	139	74131	360; 432	74509	364; 437	74783	466
72622	376	72883	370; 433	73025	333	73530	138	73909	139	74132	361; 432	74540	364	74784	466
72625	376	72884	370; 433	73026	333	73532	138	73929	139	74133	361; 432	74541	364	74785	467
72626	376	72885	370; 433	73027	333	73533	138	73931	371; 434	74134	361; 432	74542	365	74786	467
72627	376	72886	370; 433	73031	333	73534	138	73932	371; 434	74135	361; 432	74543	365	74787	467
72630	376	72887	370; 433	73032	333	73535	138	73933	371; 434	74136	361; 432	74555	365	74788	467
72631	376	72888	370; 433	73033	333	73536	138	73934	371; 434	74137	361; 432	74580	369; 437	74789	467
72632	376	72889	372	73034	333	73539	138	73935	371; 434	74140	363	74581	369; 437	74790	467
72683	372	72890	372	73035	333	73540	138	73936	371; 434	74145	362	74595	369; 436	74791	467
72684	372	72891	372	73051	261	73561	138	73937	371; 434	74146	362	74600	368; 435	74792	467
72685	372	72892	344	73052	256	73562	138	73938	371; 434	74148	363	74601	369; 436	74793	468
72686	372	72922	344	73056	256	73563	138	73939	371; 434	74149	363	74602	369; 436	74794	468
72801	372	72928	342	73057	256	73565	138	73940	371; 434	74150	362	74603	369; 436	74802	349
72802	372	72931	343	73060	262	73567	138	73941	371; 434	74151	362	74610	368; 435	74804	349
72803	372	72932	344	73200	278	73568	138	73942	371; 434	74152	363	74622	368; 435	74812	349
72804	372	72933	332	73201	278	73569	138	73943	371; 434	74153	363	74624	368; 435	74816	350
72805	372	72934	332	73202	278	73570	138	73945	371; 434	74154	363	74626	373	74818	350
72806	372	72935	332	73203	278	73571	138	73946	371; 434	74160	362	74627	373	74820	350
72807	372	72936	332	73205	278	73572	138	73947	371; 434	74162	362	74628	373	74828	350
72808	372	72937	332	73206	278	73573	138	73949	371; 434	74190	369; 436	74631	373	74831	350
72809	372	72938	333	73207	279	73574	138	73950	371; 434	74191	369; 436	74632	373	74833	350
		72939	333	73208	279	73575	138	73951	371; 434	74192	369; 436	74633	373	74835	350
		72942	333					73952	371; 434						

No.	Page	No.	Page	No.	Page	No.	Page	No.	Page	No.	Page	No.	Page	No.	Page
74838	350	75239	142: 174	75389	470	75645	476	75813	457	76640	108	77400	290	78123	249
74841	350	75240	142: 174	75421	470	75646	476	75814	457	76650	108	77500	290	78124	249
74843	350	75245	141: 174	75422	470	75647	476	75815	458	76660	108	77600	290	78127	250
74846	350	75246	141: 174	75423	470	75648	476	75816	458	76700	112	77603	290	78128	250
74849	350	75247	141: 174	75424	470	75649	476	75817	458	76705	112	77607	290	78130	250
74851	351	75260	141: 174	75448	470	75650	476	75818	458	76710	112	77700	291	78150	247
74853	351	75261	141: 174	75449	470	75651	476	75827	458	76750	349	77715	305	78154	252
74855	351	75262	141: 174	75450	470	75652	477	75828	458	76751	349	77795	305	78157	252
74856	351	75270	141: 173	75451	470	75653	477	75829	459	76752	349	77815	293: 303	78300	217
74858	350	75271	141: 173	75455	490	75654	477	75830	460	76755	349	77830	292: 302	78303	217
74861	351	75272	141: 173	75464	490	75655	477	75831	460	76756	349	77831	292: 302	78306	217
74863	351	75273	141: 173	75465	489	75660	479	75832	460	76757	349	77833	292: 302	78341	124
74866	351	75274	141: 173	75467	489	75661	479	75833	460	76760	349	77834	292: 302	78381	124
74869	351	75285	141: 173	75468	490	75662	455	75834	459	76761	349	77835	292: 302	78385	124
74882	351	75286	141: 173	75469	490	75663	455	75835	459	76762	349	77837	292: 302	78400	221
74885	351	75287	141: 173	75470	490	75664	455	75836	459	76765	349	77838	292: 302	78401	221
74886	351	75288	141: 173	75483	471	75665	455	75837	459	76766	349	77840	293: 303	78405	221: 383
74887	351	75295	140	75484	471	75670	465	75838	459	76767	349	77845	292: 302	78432	288
74910	351	75300	141: 175	75487	471	75671	465	75870	456	76800	273	77850	293: 303	78434	288
74911	351	75301	140: 175	75498	471	75672	465	75871	456	76801	273	77861	293: 303	78436	288
74912	351	75302	140: 175	75499	471	75673	465	75915	352: 493	76806	273	77870	293: 303	78450	355
74913	351	75303	141: 175	75527	475	75674	466	75916	352: 493	76807	273	77872	293: 303	78451	355
74914	351	75304	141: 175	75535	475	75675	464	75921	495	76810	273	77881	293: 303	78463	291
74920	352	75327	471	75536	475	75676	464	75922	495	76811	273	77900	291	78477	213
74921	352	75345	469	75537	475	75677	464	75923	495	76814	273	77910	291	78540	330
74922	352	75346	469	75539	475	75678	465	75924	495	76815	273	77920	292	78541	330
74923	352	75347	469	75540	471	75679	465	75930	494	76818	273	77921	292	78542	330
74924	352	75348	469	75541	472	75716	455	75931	494	76819	273	77930	292	78543	330
74935	352	75349	469	75543	472	75718	455	75932	494	76822	273	78000	216	78555	330
74936	352	75350	469	75544	472	75719	456	75944	493	76823	273	78001	216	78556	330
74937	352	75351	469	75545	472	75740	460	75945	493	76826	273	78002	216	78557	330
74960	352	75352	469	75550	472	75742	460	75951	494	76827	273	78003	216	78570	330
74973	356	75353	469	75551	472	75743	461	75953	494	76830	274	78007	216	78571	330
74974	356	75354	469	75553	476	75745	463	75980	480	76832	274	78020	344	78572	330
74975	356	75355	469	75554	476	75747	463	75981	480	76835	274	78021	344	78575	330
74983	356	75356	469	75555	479	75748	463	75982	480	76836	274	78022	344	78576	330
75000	142	75360	469	75556	479	75749	463	76000	108	77004	289	78027	140	78577	330
75012	143	75361	469	75558	479	75760	461	76010	108	77005	289	78030	217	78580	330
75028	143	75362	469	75559	479	75762	462	76011	109	77006	289	78031	217	78581	330
75031	143: 175	75363	469	75564	475	75763	462	76015	109	77061	289	78035	217	78582	330
75035	143	75364	469	75565	476	75764	462	76101	109	77062	289	78040	215	78585	330
75036	143	75365	469	75578	476	75765	462	76160	109	77063	289	78041	215	78586	330
75050	142	75366	469	75579	476	75767	462	76180	109	77064	289	78042	215	78587	330
75060	142	75367	470	75597	476	75768	462	76181	109	77170	291	78043	215	78590	331
75100	142: 174	75368	470	75619	474	75705	463	76182	110	77171	291	78044	217	78591	331
75120	141: 173	75369	470	75620	474	75706	463	76183	110	77180	291	78045	215	78592	331
75121	141: 173	75370	470	75621	474	75707	464	76184	109	77190	291	78046	215	78620	288
75122	141: 173	75371	470	75622	475	75708	464	76185	109	77191	291	78047	215	78622	288
75123	141: 173	75372	470	75623	475	75709	464	76186	110	77192	291	78050	215	78624	288
75124	141: 173	75373	470	75624	474	75770	461	76190	110	77193	291	78061	216	78626	289
75125	141: 173	75374	470	75625	473	75772	461	76210	110	77200	291	78067	216	78628	289
75130	141: 174	75375	470	75626	473	75773	461	76214	110	77203	291	78068	216	78630	289
75131	141: 174	75376	470	75627	472	75774	461	76220	110	77204	291	78101	247	78632	289
75132	141: 174	75377	470	75628	473	75801	454	76230	110	77205	291	78102	248	78633	289
75133	141: 174	75378	470	75629	472	75802	454	76250	110	77210	290	78105	248	78641	288
75140	142: 174	75379	470	75631	473	75803	454	76280	110	77211	290	78106	248	78642	288
75141	142: 174	75380	470	75632	473	75804	454	76305	111	77212	290	78110	248	78660	345
75200	126	75381	470	75633	473	75805	456	76311	111	77213	290	78111	248	78661	346
75201	126	75382	470	75634	473	75806	456	76312	112	77230	290	78112	248	78700	296
75202	126	75383	470	75635	473	75807	456	76314	112	77231	290	78115	249	78710	296
75230	142	75384	470	75636	474	75808	457	76320	59	77241	290	78116	249	78720	296
75231	142	75386	470	75637	474	75809	457	76526	108	77250	290	78118	226: 383	78730	296
75233	142	75387	470	75638	474	75811	457	76621	108	77300	290	78121	249	78731	214: 296
75238	142: 174	75388	470	75639	474	75812	457	76622	108	77350	290	78122	249	78734	214: 297

No.	Page	No.	Page	No.	Page	No.	Page	No.	Page	No.	Page	No.	Page	No.	Page
78736	214; 297	79088	251	79491	254	79982	275	81115	197	81784	60; 184	82404	237	82790	378
78738	214; 297	79089	251	79493	260	79983	275	81117	197	81785	191	82405	237	82791	378
78750	296	79090	247	79500	264; 428	79984	275	81118	197	81790	190	82406	237	82841	379
78751	296	79094	253	79501	264; 428	80012	226	81119	197	81801	61; 183	82407	237	82842	379
78752	296	79095	253	79510	264; 428	80022	226	81122	198	81820	222	82408	237	82843	379
78785	298	79119	253	79520	264; 428	80032	226	81133	198	81824	222	82409	237	82844	379
78790	298	79124	253	79530	264; 429	80042	226	81142	199	81825	222	82410	237	82845	379
78791	298	79125	260	79550	268; 429	80052	226	81370	206	81830	213	82411	237	82846	379
78793	298	79151	253	79551	268; 430	80062	226	81371	206	82000	230; 304	82412	237	82847	380
78794	299	79205	258	79552	268; 430	80072	226	81372	206	82001	230; 304	82413	237	82848	380
78800	297	79206	258	79570	270	80082	226	81373	206	82005	230; 304	82414	237	82910	233
78801	297	79207	258	79572	270	80111	227	81374	206	82015	230; 304	82415	237	82920	233
78802	297	79239	244	79580	270	80120	227	81378	207	82020	230; 304	82431	232	82939	233
78811	298	79240	254	79600	271	80121	227	81379	207	82021	230; 304	82440	232	82941	273
78812	298	79254	255	79620	271	80233	227	81380	207	82022	230; 305	82445	232	82942	260
78813	298	79257	255	79630	271	80252	227	81387	207	82031	304	82502	233	82951	234; 343
78814	298	79275	245	79640	272	80271	227	81390	207	82032	304	82504	233	82952	234; 343
78815	298	79307	253	79641	271	80300	228	81391	207	82105	231	82506	233	82953	234; 343
78819	299	79309	254	79662	256	80307	228	81399	207	82107	231	82520	233	82954	234; 343
78821	299	79314	260	79771	264; 402	80308	228	81400	207	82200	231	82541	229	82991	235; 442
78822	299	79318	261	79772	264; 402	80309	228	81401	207	82201	231	82542	229	82992	235; 442
78824	299	79320	255	79773	264; 402	80312	228	81490	206	82205	231	82543	229	83000	233
78825	299	79324	261	79774	264; 402	80320	228	81491	206	82206	231	82544	229	83001	233
78826	299	79325	261	79775	264; 402	80330	228	81492	206	82209	231	82555	229	83002	233
78830	299	79327	255	79781	259; 401	80340	228	81500	206	82225	231	82610	229	83004	234
78831	299	79328	256	79782	259; 401	80350	228	81501	206	82227	232	82611	229	83005	234
78833	299	79346	272	79783	259; 401	80402	228	81502	206	82231	232	82650	229	83009	216
78834	299	79350	268	79790	265; 402	80412	228	81519	206	82232	232	82671	377; 443	83120	385
78835	299	79351	268	79791	265; 402	80450	228	81520	206	82233	232	82673	377; 443	83121	385
78854	258	79354	257	79792	265; 402	80470	219	81521	206	82234	232	82675	377; 443	83122	386
78870	342	79355	262	79800	271	80471	219	81522	206	82300	236	82677	377	83123	386
78872	256; 342	79358	268	79810	265; 402	80472	219	81523	206	82301	236	82682	377	83124	386
78874	257; 343	79363	262	79811	265; 402	80473	219	81524	206	82305	236	82684	377	83260	235
78890	263	79364	258	79812	265; 402	80474	219	81525	206	82308	236	82685	377	83261	235
78894	260	79365	257	79861	429	80500	218	81527	206	82310	236	82691	377	83262	235
78910	125; 259	79366	257	79862	429	80510	218	81553	206	82315	236	82692	377	83266	235
78911	124; 263	79367	257	79863	429	80520	218	81556	206	82320	236	82693	377	83267	235
78912	124; 258	79368	257	79865	429	80530	218	81560	205	82331	236	82694	377	83280	236
78960	244	79373	262	79866	429	80600	219	81562	205	82341	236	82699	223; 381	85020	238; 341
78961	251	79376	257	79867	429	80601	219	81570	205	82343	238	82706	224; 381	85030	238; 341
78968	251	79377	257	79869	429	80620	219	81617	200	82351	237	82713	224; 381	85040	238; 341
78970	244	79378	257	79880	265; 402	80640	219	81618	200	82355	76	82714	224; 381	85050	238; 341
78971	244	79382	262	79909	259; 401	80660	220	81631	200	82360	236	82715	224; 381	85060	238; 341
78972	251	79383	262	79919	270	80661	220	81632	201	82370	236	82716	224; 381	85080	238; 341
78974	251	79385	262	79926	265; 403	80701	219	81633	201	82372	237	82717	224; 381	85090	238; 341
78981	250	79386	273	79927	265; 403	80751	230	81634	201	82373	237	82719	223; 380	85100	238; 341
78982	250	79390	274	79928	265; 403	80752	230	81637	200	82374	237	82720	223; 380	85112	238; 340
78983	250	79391	274	79929	266; 403	80753	230	81638	200	82375	237	82723	223; 381	85113	238; 340
78985	251	79393	257	79930	266; 403	80901	199	81640	201	82377	237	82724	224; 381	85114	238; 340
78986	251	79394	257	79931	266; 403	80902	199	81643	201	82378	237	82726	225; 382	85115	238; 340
78987	251	79396	257	79932	266; 403	80903	200	81644	201	82379	237	82728	223; 380	85116	238; 340
78990	252	79397	257	79933	266; 403	80970	197	81647	201	82380	237	82729	223; 380	85118	238; 340
78992	246	79398	274	79943	259; 402	81060	199	81650	199	82384	237	82730	225; 382	85119	238; 340
78995	246	79415	261	79944	265; 402	81070	198	81651	199	82386	237	82731	225; 382	85120	238; 340
78997	246	79416	255	79960	400	81072	198	81653	199	82388	237	82733	225; 382	85122	238; 340
79013	244	79420	254	79962	400	81073	198	81661	199	82390	237	82735	225; 382	85123	238; 340
79023	246	79442	266; 429	79963	400	81080	198	81731	191; 221	82392	237	82742	225; 382	85124	238; 340
79036	247	79444	266; 429	79965	400	81100	196	81762	191	82393	237	82756	226; 383	85125	238; 340
79046	260	79448	267; 429	79968	400	81101	196	81773	60; 182	82395	237	82771	378	85126	238; 340
79049	246	79467	266; 428	79971	400	81107	196	81774	61; 182	82397	238	82772	378	85128	238; 340
79053	247	79468	269; 430	79973	400	81108	196	81775	61; 183	82400	237	82786	378	85129	238; 340
79054	246	79473	254	79977	275	81109	196	81780	60; 182	82401	237	82787	378	85130	238; 340
79076	247	79474	254	79978	275	81110	196	81782	190	82402	237	82788	378	85170	238; 341
79087	251	79476	255	79979	275	81114	197	81783	60; 182	82403	237	82789	378	85172	239; 341

No.	Page	No.	Page	No.	Page	No.	Page	No.	Page	No.	Page	No.	Page	No.	Page
85174	239; 341	87433	348	89113	392	89270	397	89425	269; 430	99008	407	99408	423	99760	449
85177	239; 341	87435	348	89120	394	89271	398	89426	269; 430	99009	408	99409	424	99782	449
85178	239; 341	87437	348	89187	393	89272	397	89441	269; 430	99028	414	99410	423	99783	449
85180	239; 341	87451	348	89189	394	89273	398	89442	269; 430	99033	413	99412	425	GV-0062	202
85185	239; 341	87452	348	89190	394	89274	398	89443	269; 430	99034	412	99413	425	GV-0082	202
85190	239; 342	87453	348	89191	395	89275	398	89444	269; 430	99035	412	99415	424	GV-0083	201
85191	239; 342	87454	348	89192	395	89277	398	89452	269; 430	99036	412	99416	424	GV-0400	202
86700	345	87455	348	89193	394	89280	398	89453	269; 430	99037	413	99418	424	GV-0420	202
86701	345	87456	348	89195	395	89282	393	89454	269; 430	99038	413	99419	424	GV-0510	202
86750	126	87457	348	89196	394	89290	399	89456	269; 431	99039	413	99420	424	GV-0610	202
86751	126	87600	345	89200	393	89291	399	89457	269; 431	99040	413	99421	424	GV-0620	202
86752	126	88411	302; 385	89201	393	89292	399	89458	269; 431	99047	411	99425	425	GV-0631	202
86760	126	88421	302; 385	89202	393	89293	399	89459	269; 431	99048	411	99426	425	GV-0656	203
86761	126	88422	302; 385	89203	395	89294	399	89462	269; 431	99049	412	99427	425	GV-0658	203
86770	127	88550	226; 383	89204	395	89295	399	89463	269; 431	99050	411	99428	425	GV-0700	203
86771	127	88555	226; 383	89206	396	89298	399	89464	269; 431	99051	411	99429	425	GV-0710	203
87245	347	88560	226; 383	89207	396	89299	399	89465	270; 431	99052	412	99430	425	GV-0720	203
87301	347	88670	384	89208	396	89300	399	89466	270; 431	99053	413	99435	425	GV-0730	203
87302	347	88671	384	89209	395	89302	399	89467	270; 431	99054	413	99436	425	GV-0740	203
87303	347	88672	384	89210	394	89303	399	89470	270; 431	99056	414	99438	425	GV-0861	203
87305	347	88673	384	89211	395	89305	399	89471	270; 431	99101	405	99440	425	GV-0871	203
87307	347	88674	385	89213	394	89307	399	89472	270; 431	99103	405	99442	425	GV-0925	204
87311	347	88675	385	89214	394	89308	399	89473	270; 431	99104	406	99443	425	GV-1100	204
87312	347	88676	385	89215	395	89310	399	89474	270; 431	99109	406	99444	425	GV-1101	204
87313	347	88677	384	89218	396	89311	399	89475	270; 431	99110	407	99445	425	GV-1102	204
87315	347	88678	384	89220	395	89312	399	89478	270; 431	99111	406	99446	425	GV-1105	204
87317	347	88700	438	89221	390	89313	399	89479	270; 431	99112	407	99460	71; 411	GV-1121	204
87321	347	88701	438	89222	390	89314	399	89480	270; 431	99113	406	99461	71; 411	GV-1122	204
87322	347	88702	438	89223	390	89315	399	89481	270; 431	99114	406	99462	71; 411	GV-1123	204
87323	347	88703	438	89224	390	89316	399	89482	270; 431	99115	406	99463	71; 411	GV-1150	204
87325	347	88704	438	89225	390	89318	399	89483	270; 431	99116	406	99464	71; 411	GV-1151	204
87327	347	88705	438	89226	390	89319	399	89484	270; 431	99119	406	99472	71; 411	GV-1152	204
87331	347	88720	414	89227	390	89320	399	89485	270; 431	99180	405	99512	444	GV-1160	204
87332	347	88801	438	89228	390	89330	400	89486	270; 431	99181	405	99513	444	GV-1161	204
87333	347	88805	438	89229	390	89331	400	89507	426	99182	405	99514	445	GV-1180	204
87335	347	88806	438	89230	390	89335	400	89508	426	99190	403	99519	445	GV-1181	204
87337	347	88809	438	89231	390	89336	400	89509	426	99191	404	99524	448	GV-1182	204
87351	347	88811	438	89232	390	89342	400	89515	426	99193	403	99568	450	GV-1200	204
87352	347	89000	438	89233	391	89345	401	89518	426	99194	403	99575	450	GV-1201	204
87353	347	89001	390	89234	391	89348	401	89520	426	99195	405	99576	450	GV-1202	204
87354	347	89002	390	89235	391	89351	396	89526	426	99202	404	99580	446	GV-1220	205
87361	347	89003	390	89236	391	89360	399	89528	426	99203	404	99581	446	GV-1221	205
87362	347	89004	390	89239	391	89361	399	89536	426	99204	404	99582	446	GV-1240	205
87363	347	89007	390	89240	391	89370	399	89537	426	99206	404	99583	447	GV-1241	205
87364	347	89008	390	89241	392	89371	399	89538	427	99207	404	99584	445	GV-1242	205
87371	348	89011	391	89242	392	89372	399	89539	427	99208	404	99585	447	GV-1272	205
87372	348	89013	392	89243	393	89373	399	89540	427	99209	404	99586	445	GV-1382	205
87373	348	89015	391	89244	393	89390	396	89541	427	99210	405	99587	444	GV-1384	205
87374	348	89017	392	89245	392	89401	269; 430	89542	427	99230	403	99588	444	GV-1385	205
87381	348	89018	392	89246	392	89402	269; 430	89543	427	99240	405	99589	446	GV-1386	205
87382	348	89020	392	89247	393	89403	269; 430	89545	427	99300	408	99591	447	GV-1387	205
87383	348	89022	393	89248	393	89404	269; 430	89547	427	99301	408	99592	447	GV-1388	205
87384	348	89100	390	89251	392	89405	269; 430	89552	401	99310	407	99593	448	GV-1582	205
87391	348	89101	390	89252	392	89406	269; 430	89553	401	99315	407	99633	448	GV-1583	205
87392	348	89102	390	89253	391	89411	269; 430	89560	176; 439	99390	421	99642	443		
87393	348	89103	390	89255	396	89412	269; 430	89561	176; 439	99391	421	99643	443		
87401	348	89104	391	89259	397	89413	269; 430	89562	176; 439	99400	419	99670	443		
87402	348	89105	391	89260	397	89414	269; 430	89563	176; 439	99401	421	99671	443		
87403	348	89106	392	89261	397	89415	269; 430	89564	176; 439	99402	423	99700	448		
87411	348	89107	392	89262	397	89416	269; 430	89880	413	99403	423	99701	448		
87412	348	89108	392	89263	397	89421	269; 430	99001	407	99404	423	99702	448		
87413	348	89109	392	89265	398	89422	269; 430	99005	407	99405	425	99703	449		
87431	348	89110	391	89267	398	89423	269; 430	99006	407	99406	425	99710	449		
87432	348	89112	393	89269	397	89424	269; 430	99007	407	99407	424	99711	449		

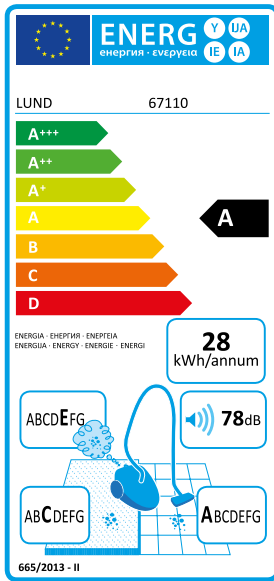

67110

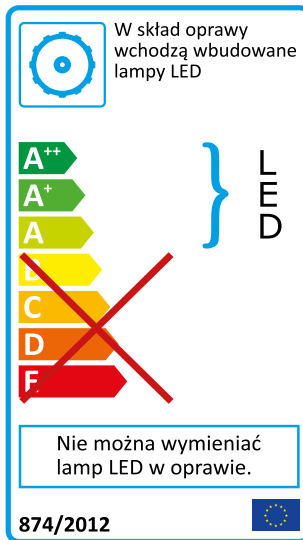

78118
82699
82706
82728
82729
82719
82720
82723

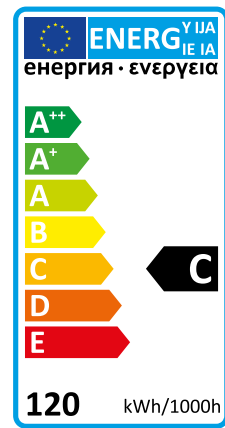

82771
82772

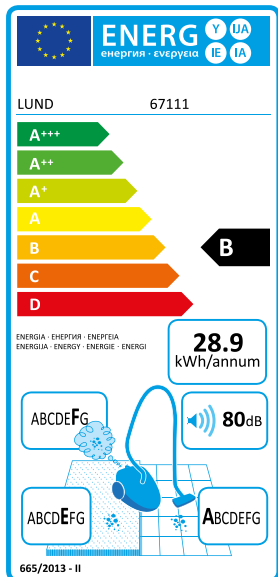

67111

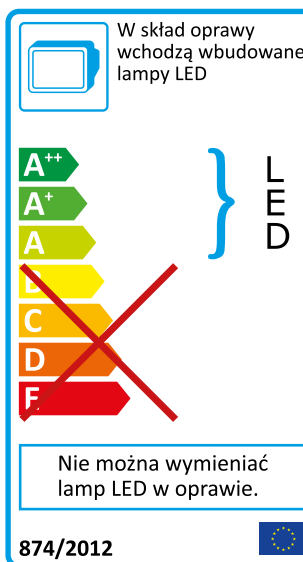

82841
82842
82483
82484
82845
82846
82847
82848

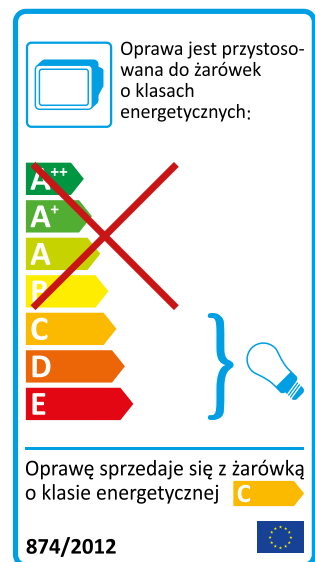

82786
82787
82788
82789
82790
82791

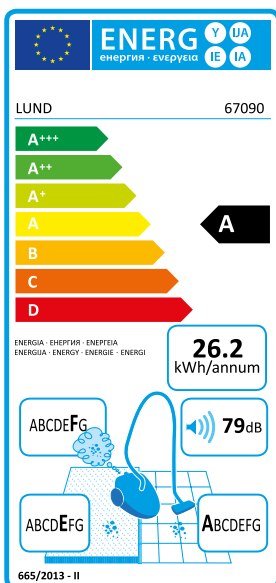

67090

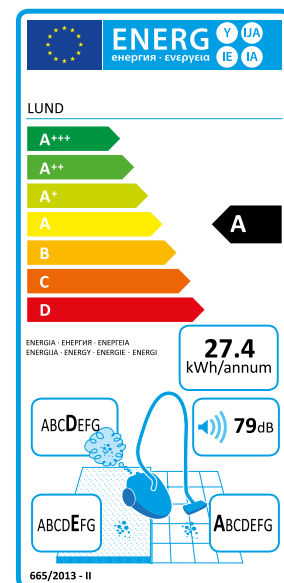

67091
67092

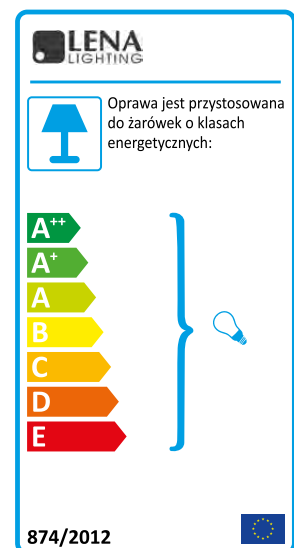

82713
82714
82715
82716
82717

PL

I. TOYA S.A. informuje, iż:

- 1) niniejszy katalog nie stanowi oferty w rozumieniu prawa cywilnego;
- 2) prezentowane w niniejszym katalogu artykuły mogą w rzeczywistości odbiegać od wskazanego na zdjęciach wzoru, w szczególności jeżeli chodzi o cechy zewnętrzne, tj. wielkość, kolor, sposób opakowania, ilość przedmiotów w opakowaniu;
- 3) nie ponosi odpowiedzialności za drobne różnice w sposobie pakowania czy właściwościach artykułów pozostających bez wpływu na jego przeznaczony cel lub sposób użytkowania;
- 4) nie ponosi odpowiedzialności wynikającej z jakichkolwiek niedokładności lub nieścisłości, co do informacji zawartych w przedmiotowym katalogu;
- 5) nie ponosi odpowiedzialności za ewentualną szkodę powstałą w wyniku otrzymania towaru o innych właściwościach niż prezentowany na zdjęciach.

II. Pomimo najlepszych starań poczynionych przez TOYA S.A. nie może ona zagwarantować, iż informacje zawarte w niniejszym katalogu w pełni odpowiadają rzeczywistości.

III. Wszelkie decyzje podjęte na podstawie informacji zawartych w przedmiotowym katalogu podejmowane są na własne ryzyko osoby, która korzysta z tych informacji.

GB

I. TOYA S.A. informs that:

- 1) the present catalogue does not constitute an offer as construed in the civil law;
- 2) the goods presented in the present catalogue may in fact differ from the models shown in the pictures, particularly as far as external properties are concerned, namely size, colour, packaging, number of items in the package;
- 3) the company will not be held responsible for small differences in packaging or properties of the goods, which do not affect the purpose or the exploitation of the tools;
- 4) the company will not be held responsible for any inaccuracies or imprecision regarding the information presented in the catalogue;
- 5) the company will not be held responsible for any damage caused by goods whose properties differ from those of the tools presented in the photographs.

II. In spite of all the efforts made by TOYA S.A., the company cannot guarantee the information contained in the present catalogue fully correspond to the reality.

III. Any decisions made on the basis of the information contained in the present catalogue will be made at the risk of the person who makes them using the aforementioned information.

D

I. TOYA S.A. informiert, dass:

- 1) der vorliegende Katalog kein Angebot im zivilrechtlichen Sinne darstellt;
- 2) die im vorliegenden Katalog präsentierten Artikel in der Realität von den auf den Musterfotos gezeigten abweichen können, und zwar besonders dann, wenn es um äußere Eigenschaften geht, wie z.B. Größe, Farbe, Art der Verpackung, Anzahl der Gegenstände in der Verpackung;
- 3) sie keine Verantwortung für geringfügige Unterschiede bei der Verpackungsart oder den Eigenschaften der Artikel übernimmt, die ohne Auswirkungen auf seinen Bestimmungszweck oder die Art der Nutzung bleiben;
- 4) sie keine Verantwortung für irgendwelche Oberflächlichkeiten und Ungenauigkeiten bzgl. der im Sachkatalog enthaltene Informationen übernimmt;
- 5) sie keine Verantwortung für eventuelle Schäden, die im Ergebnis des Erhalts der Ware mit anderen als auf den Fotos dargestellten Eigenschaften entstanden sind, übernimmt.

II. Trotz großer Bemühungen seitens TOYA S.A. kann die Firma nicht garantieren, dass die im vorliegenden Katalog enthaltenen Informationen voll der Realität entsprechen.

III. Sämtliche Entscheidungen, die auf der Grundlage der im Sachkatalog enthaltenen Informationen getroffen wurden, gehen auf das Risiko der Person, die diese Informationen benutzt.

RUS

I. TOYA S.A. заявляет:

- 1) настоящий каталог не является торговым предложением с точки зрения гражданского законодательства;
- 2) изделия, представленные в настоящем каталоге, могут отличаться от образцов на снимках, особенно внешним видом, то есть размером, цветом, способом упаковки, количеством предметов в упаковке;
- 3) производитель не отвечает за мелкие отличия в способе упаковки или свойствах изделий, которые не влияют на предназначение или способ пользования изделиями;
- 4) производитель не отвечает за мелкие неточности в сведениях из предметного каталога;
- 5) производитель не отвечает за ущерб, нанесенный вследствие поставки товара, отличающегося параметрами от указанного на снимках.

II. Несмотря на все усилия в данном направлении, компания TOYA S.A. не гарантирует, что информация, метящаяся в настоящем каталоге, полностью отвечает действительности.

III. Риск, связанный с любыми решениями, принятыми на основании информации из предметного каталога, берут на себя лица, пользующиеся указанной информацией.

UA

I. Інформація від виробника, TOYA S.A.:

- 1) цей каталог не є комерційною пропозицією з точки зору цивільного законодавства;
- 2) вироби, представлені у цьому каталозі, можуть відрізнятися від зображених на фотографіях, особливо зовнішнім виглядом, тобто розміром, кольором, способом упаковки, кількістю предметів в упаковці;
- 3) виробник не несе відповідальність за дрібні відмінності у способі упаковки чи властивостях виробів, які не мають впливу на їх призначення чи спосіб користування ними;
- 4) виробник не несе відповідальність за дрібні неточності у інформації, включеної у цей каталог;
- 5) виробник не несе відповідальність за можливі збитки, нанесені внаслідок отримання виробів, що своїми параметрами відрізняються від зображених на фотографіях.

II. Незважаючи на зусилля у даному напрямку, фірма TOYA S.A. не гарантує, що інформація, включена у цей каталог, повністю відповідає дійсності.

III. Приймаючи будь-які рішення на підставі інформації, включеної у цей каталог, не забувайте, що пов'язаний з ними ризик беруть на себе особи, що використовують включену у каталог інформацію.

LT

I. TOYA S.A. informuoja, kad:

- 1) šis katalogas nėra civilinės teisės supratimu pasiūlymas;
- 2) rodomos šame kataloge prekės gali tikrumoje skirtis nuo parodyto nuotraukose pavyzdžio, ypač jų išorine išvaizda ir požymiais, t.y. dydžiu, spalva, įpakavimo būdu, elementų kiekiu pakuotėje;
- 3) gamintojas neneša atsakomybės už nereikšmingus skirtumus įpakavime arba gaminio savybėse, kurios neturi įtakos jo paskirčiai arba jo varojimo būdui.
- 4) neneša taip pat atsakomybės dėl bet kokių netikslumų arba nepakankamai preciziškų apibrėžimų pateiktoje kataloge informacijoje.
- 5) neneša atsakomybės už galimai patirtus nuostolius gavus prekę su savybėmis, kurios nėra tapačios su pateiktomis nuotraukose.

II. Nežiūrint geriausių TOYA S.A. pastangų, bendrovė negali garantuoti, kad pateikta šiame kataloge informacija pilnai atitinka tikrovę.

III. Bet kokie sprendimai priimami šiame kataloge pateiktą informaciją pagrindu yra besinaudojančio šia informacija asmens priimami savo paties rizika.

LV

I. A/S „TOYA” informē, ka:

- 1) šis katalogs nav piedāvājums civillikuma izpratnē;
- 2) piedāvāti šī katalogā produkti realitātē var atšķirties no rādīta uz fotogrāfijas parauga, sevišķi ārēju īpašību sfērā, t.i. ar lielumu, krāsu, pakošanas veidu, priekšmetu skaitu iepakojumā;
- 3) nav atbildīga par smalkām atšķirībām iepakošanas veidā vai produktu īpašībām, ja tie neietekmē ierīces paredzētu mērķu vai lietošanas veidu;
- 4) nav atbildīga par kaut kādām neprecizitātēm informācijās, kas ir norādītas šī katalogā;
- 5) nav atbildīga par iespējamiem zaudējumiem, savienotiem ar produkta saņemšanu ar citām īpašībām, nekā rādītas uz fotogrāfijas.

II. Neskatoties uz visaugstāko rūpību, ar kuru A/S „TOYA” sagatavoja savu katalogu, tā nevar garantēt, ka informācijas šī katalogā pilnīgi atbild realitātei.

III. Visi lēmumi, pieņemti pamatojoties uz informācijas no kataloga - ir pieņemti uz personas, kura lieto šo informāciju, risku.

CZ

I. TOYA S.A. informuje že:

- 1) tento katalog nepředstavuje nabídku ve smyslu občanského práva;
- 2) výrobky prezentované v tomto katalogu se mohou ve skutečnosti lišit od modelů uvedených na obrázcích, zejména co se týká vnějších znaků, tj. velikosti, barvy, způsobu balení, počtu předmětů v balení;
- 3) nese odpovědnost za drobné rozdíly ve způsobu balení nebo ve vlastnostech výrobků, které nemají zásadní vliv na jejich určený účel nebo způsob používání;
- 4) nese odpovědnost vyplývající z jakýchkoli nepřesností co do informací uvedených v předmětném katalogu;
- 5) nese odpovědnost za případné škody vzniklé v důsledku obdržení zboží s jinými vlastnostmi, než je uvedeno na obrázcích.

II. Navzdory mimořádnému úsilí vynaloženému firmou TOYA S.A. tato nemůže garantovat, zda informace uvedené v tomto katalogu zcela odpovídají skutečnosti.

III. Veškerá rozhodnutí přijatá na základě informací uvedených v předmětném katalogu jsou přijímána na vlastní riziko osoby, která tyto informace využívá.

SK

I. TOYA S.A. informuje že:

- 1) tento katalóg nepredstavuje ponuku v zmysel občianskeho práva;

- 2) výrobky prezentované v tomto katalógu sa v skutočnosti môžu líšiť od modelov zobrazených na obrázkoch, najmä pokiaľ sa jedná o vonkajšie znaky, t.j. veľkosť, farbu, spôsob balenia, počet predmetov v balení;
- 3) nenesie zodpovednosť za drobné rozdiely v spôsobe balenia či vlastnostiach výrobkov, ktoré nemajú zásadný vplyv na ich určený účel alebo spôsob používania;
- 4) nenesie zodpovednosť vyplývajúcu z akejkoľvek nepresnosti týkajúcej sa informácií uvedených v predmetnom katalógu;
- 5) nenesie zodpovednosť za prípadné škody vzniknuté v dôsledku obdržania tovaru s inými vlastnosťami, než je uvedené na obrázkoch.

II. Aj napriek mimoriadnemu úsilíu zo strany firmy TOYA S.A. táto nemôže garantovať, či informácie uvedené v tomto katalógu plne zodpovedajú skutočnosti.

III. Všetky rozhodnutia prijaté na základe informácií uvedených v predmetnom katalógu sú prijímané na vlastné riziko osoby, ktorá tieto informácie využíva.

H

I. A TOYA S.A. tájékoztatja, hogy:

- 1) a jelen katalógus a polgári jog szerinti nem kereskedelmi ajánlat;
- 2) a jelen katalógusban bemutatott árucikkek a valóságban eltérhetnek a képeken látható mintától, különösen a külső tulajdonságok, mint a méret, szín, csomagolási mód, a csomagban lévő tárgyak száma tekintetében;
- 3) nem vállal felelősséget a csomagolás módjában vagy az árucikkek olyan tulajdonságaiban történt változtatásokért, amelyek nem befolyásolják lényeges módon annak rendeltetését vagy a felhasználás módját;
- 4) nem vállal felelősséget a jelen katalógusban lévő információk pontatlanságáért;
- 5) nem vállal felelősséget azokért az esetleges károkért, amik az árucikkek a fényképeken látható tulajdonságoktól eltérő tulajdonságokkal történő leszállításból erednek.

II. A TOYA S.A. minden igyekezete ellenére nem tudja garantálni, hogy a jelen katalógusban

található információk teljes egészében megfelelnek a valóságnak.

III. A tárgyi katalógusban található információk alapján meghozott bármilyen döntés annak a személynek a rizikója, aki ezeket az információkat felhasználja.

RO

I. TOYA S.A. informează că:

- 1) prezentul catalog nu constituie ofertă în înțelesul dreptului civil;
- 2) articolele prezentate în prezentul catalog se pot diferi față de mostrele din fotografiile, în special aspectul exterior, adică mărimea, culoarea, modul de ambalare, cantitatea obiectelor în ambalaj;
- 3) nu-și asumă răspunderea referitor la mici diferențe la modul de ambalare sau la articole al căror proprietăți nu au influență referitor la destinația sau modul lor de utilizare;
- 4) nu-și asumă răspunderea referitor la orice inexactitate sau imprecizie, datorită informațiilor cuprinse în catalogul respectiv;
- 5) nu-și asumă răspunderea referitor la o eventuală pagubă ca urmare primirii marfei cu alte proprietăți decât cele prezentate pe fotografii;

II. Cu toate strădanile TOYA S.A., firma nu poate garanta că, informațiile din prezentul catalog corespund realității;

III. Orice decizie preluată în baza informațiilor cuprinse în catalogul respectiv, sunt preluate pe riscul și răspunderea persoanei care a făcut folos de aceste informații.

E

I. TOYA S.A. comunica lo siguiente:

- 1) el presente catálogo no constituye una oferta, en el sentido que la noción adquiere en la ley civil;
 - 2) los artículos presentados en el presente catálogo pueden en realidad diferir de los modelos indicados en las fotografías, especialmente en cuanto a sus propiedades externas, es decir el tamaño, el color, el empaque o la cantidad de los objetos en el empaque;
 - 3) la empresa no se hace responsable por pequeñas diferencias en cuanto al empaque o las propiedades de los artículos, siempre y cuando estas diferencias no afectan el propósito o el modo de operación de las herramientas;
 - 4) la empresa no se hace responsable por ninguna imprecisión en cuanto a la información presentada en el presente catálogo;
 - 5) la empresa no se hace responsable por ningún daño que surja del hecho de que los artículos recibidos difieran de los artículos presentados en las fotografías en cuanto a sus propiedades.
- II. A pesar de los mejores intentos de parte TOYA S.A. la empresa no puede garantizar que la información presentada en el presente catálogo corresponda completamente a la realidad.
- III. Todas las decisiones tomadas en base a la información presentada en el presente son responsabilidad de la persona que recurra a la dicha información.





REG-707
Branded rack YATO 100 cm /
Regał firmowy YATO 100 cm



REG-777
Hangers set for power tools YATO /
Zestaw zawieszni na elektronarzędzia YATO



REG-779
Hangers set for power tools YATO 18 V /
Zestaw zawieszni na elektronarzędzia YATO 18 V



REG-918
Display for sanding paper YATO in rolls /
Ekspozytor na papier ścierny YATO w rolkach



REG-919
Display for sanding paper YATO in sheets /
Ekspozytor na papier ścierny YATO w arkuszach



REG-908
Standing display for YATO rectifiers /
Ekspozytor stojący na prostowniki YATO



REG-925
Display for YATO work clothes /
Ekspozytor na ubrania robocze YATO



REG-603
Rotary display rack YATO /
Ekspozytor obrotowy YATO



REG-776
Standing triangular display for YATO sets /
Trójstronny ekspozytor stojący na zestawy YATO



REG-763
Standing display for YATO shoes /
Ekspozytor stojący na buty YATO



REG-977
Chrome tube mannequin /
Manekin z rury chromowej



REG-764
Standing display for YATO levels /
Ekspozytor stojący na poziomie YATO



REG-708
Branded rack VOREL 100 cm /
Regał firmowy VOREL 100 cm



REG-999
Standing display for window seals VOREL /
Ekspozytor stojący na uszczelki na okien VOREL



REG-954
Display for ropes / Ekspozytor na liny



REG-706
Branded rack STHOR 100 cm /
Regał firmowy STHOR 100 cm



REG-709
Branded rack FLO 100 cm /
Regał firmowy FLO 100 cm

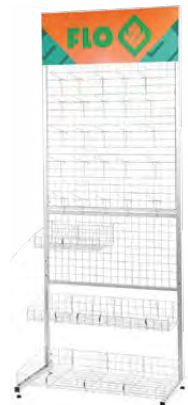

REG-715
Mesh display rack FLO 230 cm /
Regał siatkowy FLO 230 cm



REG-147
Kitchen faucet display rack FALA /
Ekspozytor na baterie kuchenne FALA



REG-146
Bath faucet display rack FALA /
Ekspozytor na baterie łazienkowe FALA



REG-149
Stand for linear drains FALA /
Ekspozytor na odpływy liniowe FALA



REG-808
Display for wave toilet seats FALA /
Ekspozytor na deski toaletowe FALA



REG-992
Display rack for REG-707 for pipe wrenches YATO /
Ekspozytor do REG-707 na klucze do rur YATO



REG-994
Display rack for REG-707 for YATO bits /
Ekspozytor do REG-707 na nasadki YATO



REG-994P
Display rack with the lid for REG-707 for YATO bits /
Ekspozytor z pokrywą do REG-707 na nasadki YATO

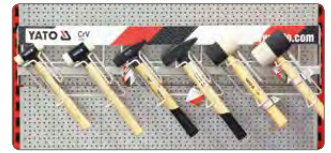

REG-998
Display rack for REG-707 for YATO hammers /
Ekspozytor do REG-707 na młotki YATO



REG-993
Display rack for REG-707 for YATO pneumatic tools /
Ekspozytor do REG-707 na narzędzia pneumatyczne YATO

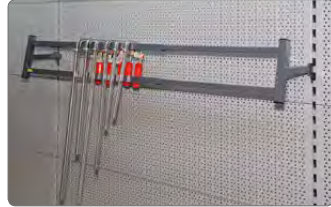

REG-951
Display for carpentry clamps /
Ekspozytor na ściśki stolarskie



REG-804
Tag for YATO shoes / Zawieszka na buty YATO



REG-991
Display rack for REG-707 for YATO disc saws /
Ekspozytor do REG-707 na płyty tarczowe YATO



REG-952
Display for the disc for disc cutters /
Ekspozytor na tarcze do szlifierek kątowych



REG-761
Hook for axes / Wieszak na siekiery



REG-930
Display for YATO buck saws /
Ekspozytor na piły kabłąkowe YATO



REG-909
Display stand for FLO garden tools /
Ekspozytor na narzędzia ogrodowe FLO



REG-868
Hook 30 cm for trowels / Hak 30 cm na kielnie



REG-144
Pendant for wall mounted faucet FALA /
Zawieszka na baterię ścienną FALA



REG-145
Pendant for deck mounted faucet FALA /
Zawieszka na baterię stojącą FALA



REG-911
Pallet display for garden tools /
Ekspozytor paletowy na narzędzia ogrodnicze



REG-799
Display stand VOREL /
Display ekspozycyjny VOREL



REG-902
Standing display for YATO sockets /
Ekspozytor stojący na nasadki YATO



REG-807
Display box for STHOR drill bits /
Ekspozytor skrzynka na wiertła STHOR



REG-604
Wall-stand display rack YATO /
Ekspozytor stojąco-wiszący YATO



REG-605
Waterfall display rack YATO /
Ekspozytor kaskadowy YATO































REG-705
Advertising wobler YATO /
Wobler reklamowy YATO



REG-803
YATO wrench tester /
Tester kluczy YATO



REG-711
Rack shelf for REG-707 YATO /
Półka do REG-707 YATO

	Colour box		Sleeve
	Box with colour label		Carton envelope
	PVC colour box		Bulk
	Box		Plastic holder
	Display colour box		Flag tied on card
	Hanging colour box		Metal box
	Blister card		Metal box with colour label
	Double blister card		Metal box with sleeve
	Double blister transparent		Plastic box
	Half double blister card		Plastic box with colour sleeve
	Sliding card		Plastic case with colour label
	Plastic hanger		Plastic case with label
	Hanging card		Plastic case with colour sleeve
	Header card		Plastic tube with colour label
	Tied on card		Metal clip
	Skin card		Wooden box with sleeve
	Polybag with header card		Pouch
	Polybag		Shrink card / Plastic tray
	Printed polybag		
	Polybag with hanger		



MANUFACTURER / PRODUCENT

TOYA S.A.
ul. Soltysowicka 13-15
51-168 Wrocław
☎ (+48 71) 32 46 200
fax: (+48 71) 32 46 370

sales@yato.pl (sale)
export@yato.pl (export)
import@yato.pl (import)

ODDZIAŁ WARSZAWSKI
Teren ProLogis Park Nadarzyn
al. Kasztanowa 160
05-831 Młochów k. Warszawy

☎ (+48 22) 73 82 800
☎ (+48 22) 73 82 828
sales@yato.pl (sale)
export@yato.pl (export)

TOYA ROMANIA S.A.
Șos. Ștefănești, 8 - 8A,
Ștefănești De Jos, Ilfov
☎ (+40 031) 710 8692
office@yato.ro

YATO TOOLS (SHANGHAI) CO.,LTD.
No. 1, Lane 1300, East Kangqiao Road
Shanghai, China 201315
☎ (+86 21) 681 829 50
fax: (+86 21) 681 829 51
yato@yato-sh.com

YATO TOOLS (JIAXING) CO.,LTD
Room. 239, No. 8 Baibu Avenue, Baibu Town,
Haiyan County, Jiaxing City, Zhejiang Province, China
☎ (+86 21) 681 829 50
yato@yato-sh.com

YOUR TRUSTED SUPPLIER / TWÓJ ZAUFANY DOSTAWCA



GET ACQUAINTED WITH OUR WIDE OFFER /
ZOBACZ NASZĄ BOGATĄ OFERTĘ

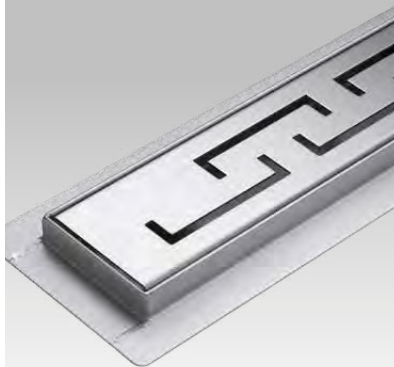

5 906083 000300 >

Copyright © TOYA S.A.